

CATÁLOGO GENERAL

**2024
2025**





Agrupación de Suministros
Industriales de España, S.L.



CATALOGO DIGITAL



PIM

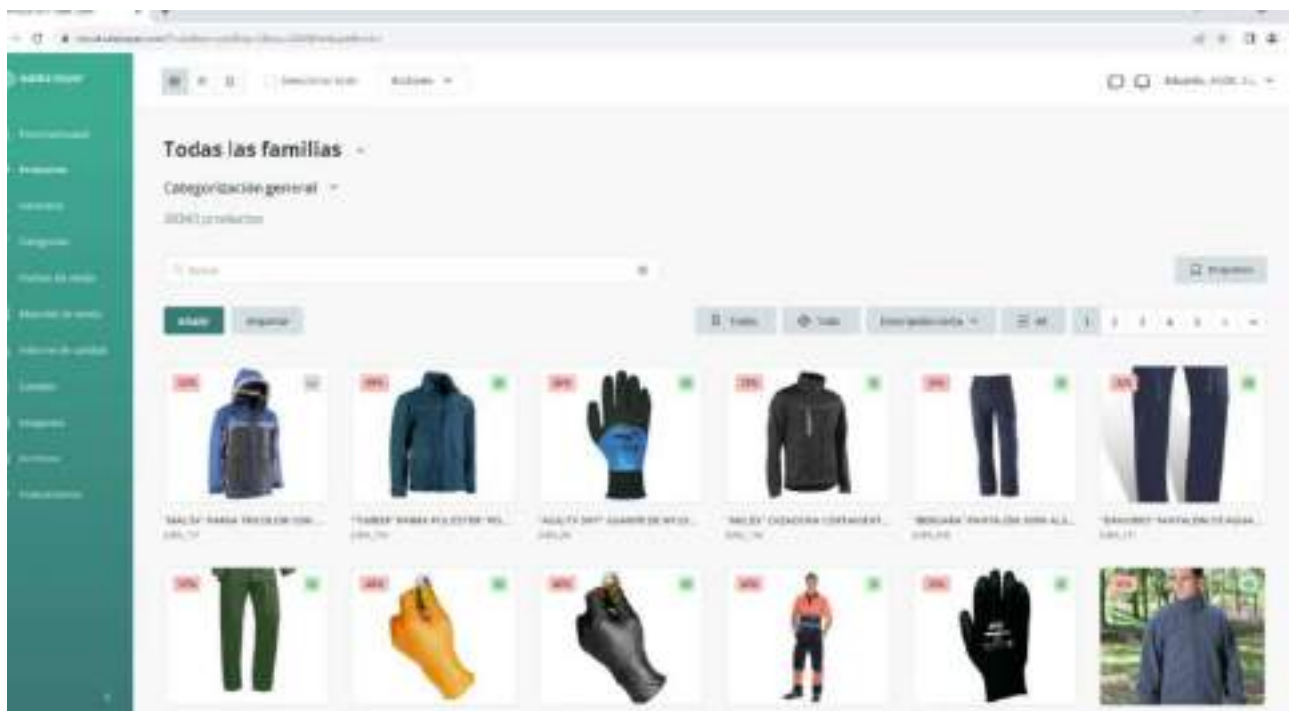







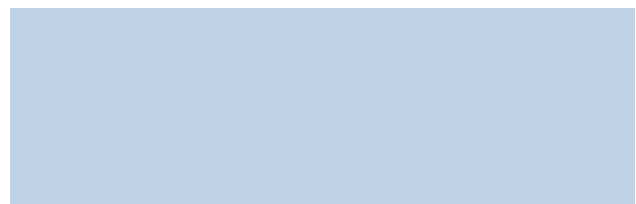







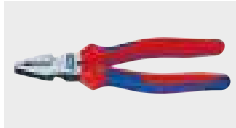

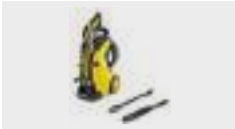

















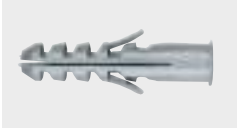









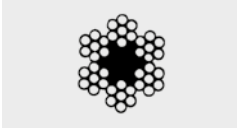

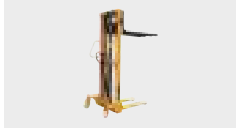

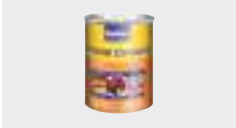

sinex®



ÍNDICE ICONOGRÁFICO

01	22 Llaves ajustables 	45 Llaves allen 	53 Llaves de vaso 	109 Destornilladores 	131 Alicates 
02	234 Herramienta eléctrica 	266 Herramienta a batería 	287 Hidrolimpiadoras 	295 Herramienta neumática 	320 Taladros de columna 
03	380 Brocas 	396 Escariadores 	397 Machos 	406 Fresas rotativas 	413 Fresas frontales 
04	456 Muelas 	456 Muelas cilíndricas 	459 Abanicos lijadores 	463 Manguitos lijadores 	472 Muelas de fieltro 
05	524 Soldadura oxiacetilénica 	526 Soldadura aerobutánica 	526 Soldadores 	532 Inverter 	538 Máquinas de hilo 
06	551 Tacos de nylon 	555 Anclajes metálicos 	561 Abrazaderas isofónicas 	562 Abrazaderas 	577 Abarcones 
07	630 Protección de cabeza 	633 Protección ocular 	648 Ropa laboral 	689 Ropa alta visibilidad 	705 Protección de las manos 
08	828 Cable y accesorios 	848 Polipastos 	856 Gatos 	862 Apilador 	865 Ruedas 
09	982 Fijación y sellado 	983 Adhesivos de contacto 	990 Pinturas 	997 Limpiadores 	1002 Selladores de silicona 
10	1084 Calibres 	1087 Relojes comparadores 	1088 Micrómetros 	1089 Escuadras 	1091 Reglas 

155 | Tenazas



173 | Extractores



188 | Sargentos



201 | Martillos

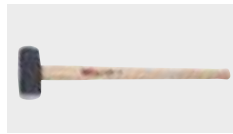

218 | Palas



HERRAMIENTA
MANUAL

263 | Fresadoras



332 | Sierras de cinta

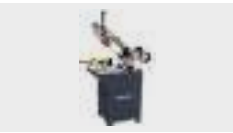

340 | Tornos



346 | Cizallas



367 | Compresores

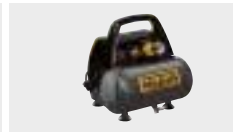

HERRAMIENTA
PARA TALLER

420 | Plaquitas



441 | Accesorios



442 | Sierras de mano



443 | Sierras



449 | Coronas



HERRAMIENTA
DE CORTE

477 | Lijas



487 | Discos de láminas



495 | Discos de diamante



495 | Discos



507 | Cardas

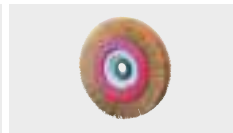

ABRASIVOS

540 | Soldadura por puntos



541 | Plasma



542 | Pinzas



543 | Antorchas



546 | Electrodo



SOLDADURA

578 | Impulsión pólvora



583 | Remaches

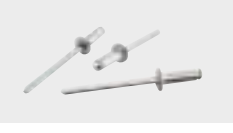

589 | Tornillos



614 | Tuercas



621 | Arandelas



FIJACIÓN

747 | Protección de los pies



781 | Protección anticaídas



794 | Protección respiratoria



804 | Protección auditiva



815 | Señalización



PROTECCIÓN
LABORAL

904 | Mobiliario



932 | Maletas porta herramientas



948 | Escaleras



965 | Extensibles de cable

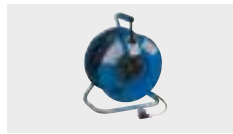

966 | Focos LED



EQUIPAMIENTO
PARA TALLER

1019 | Anclajes químicos



1021 | Cintas



1034 | Lubricantes



1043 | Grasas



1059 | Mangueras

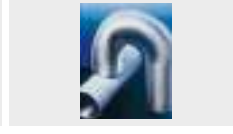

PRODUCTOS
QUÍMICOS

1093 | Compases

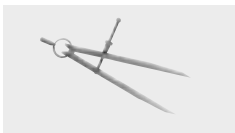

1096 | Galgas



1101 | Niveles



1104 | Flexómetros

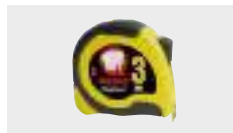

1111 | Instrumentación



MEDICIÓN



ÍNDICE ALFABÉTICO

A

PÁG.

Abanicos lijadores	4 459
Abanicos para máquinas angulares	4 466
Abrazaderas isofónicas	6 561
Abrazaderas metálicas	6 562
Accesorios de cable. Cáncamos	8 833
Accesorios de cable. Grilletes rectos	8 835
Accesorios de cable. Sujetacables	8 832
Accesorios de cable. Tensores	8 829
Accesorios de cadenas grado 100	8 843
Accesorios de cadenas grado 80	8 840
Accesorios estanterías	8 947
Accesorios soldadura eléctrica	5 542
Aceiteras	9 1052
Aceites de corte	9 1041
Adhesivo universal instantáneo	9 984
Adhesivos	9 985
Adhesivos de montaje	9 1013
Adhesivos para uniones de PVC	9 983
Aerografía	2 311
Agitadores	2 252
Alargadores de conos	3 441
Alcotanas	1 200
Alicata para tuberías y racores	1 159
Alicates	1 132
Alicates para electrónica	1 149
Almacenaje de bidones	8 940
Amoladoras	2 244
Amoladoras rectas	2 247
Anclajes metálicos	6 555
Anclajes químicos	6 558
Anclajes químicos	9 1019
Anemómetros	10 1116
Antideslizantes y absorbentes	7 807
Antideslizantes y antifatiga	7 807
Antiproyecciones soldadura	9 988
Antorchas MIG-MAG	5 543
Antorchas TIG	5 544

Apiladores	8 862
Arandelas	6 622
Arandelas. Planas	6 621
Arcos de sierra	3 444
Armario multiusos	8 909
Armarios botiquín	8 910
Armarios de cajones	8 908
Armarios para herramientas	8 906
Armarios para ordenadores	8 909
Asiento	8 912
Aspirador en seco y húmedo	2 291
Aspiradores	2 291
Aspiradores de aceite	9 1057
Aspiradores de humos	5 542
Atornillador angular	2 268
Atornilladores	2 248
Atornilladores de impacto	2 249
Atornilladores de impacto	2 276
Azadas	1 219

B

PÁG.

Balancín	8 854
Bancos de trabajo	8 904
Bancos de vestuario	8 911
Bandejas para estanterías	8 947
Barredoras	2 288
Bases múltiples	8 965
Baterías	8 972
Baúles porta-herramientas	8 921
Bidones	8 940
Biseladora	2 250
Biseladora	2 252
Bobinas de celulosa	8 978
Bolsas de herramientas	8 923
Bombas	8 862
Bombas de agua	9 1057
Bombas de engrase	9 1053
Bombas de engrase manual	9 1047

Bombas equipadas para transvase de aceite	9 1056	Cilindro para plancha	2 348
Bordonadoras	2 346	Cilindros	8 926
Botadores	1 210	Cinceles	1 206
Bridas	6 578	Cintas	9 1021
Brocas de centrar	3 391	Cintas de embalaje	9 1027
Brocas de construcción	3 391	Cintas de espesores	10 1099
Brocas helicoidales mango cilíndrico	3 380	Cintas de sierra	3 444
Brocas helicoidales mango cónico	3 390	Cintas métricas	10 1108
Brocas madera	3 395	Cizalla, plegadora y curvadora de chapa	2 348
Buriles	1 208	Cizallas	2 251

C

PÁG.

Caballetes plegables	1 213	Clavadora y Grapadora	2 286
Cabinas	2 351	Cofres de herramientas de plástico	8 933
Cables de acero	8 828	Cola termofusible	9 986
Cabrestantes	8 855	Colas blancas	9 986
Cadena comercial	8 840	Compases	10 1093
Cadena grado 80	8 839	Compresor a batería	2 366
Cajas de herramientas	8 920	Compresores	2 366
Cajas de herramientas de plástico	8 932	Comprador de diferenciales digital	10 1117
Cajas para almacén y transporte	8 938	Compradores de Tierra	10 1111
Calibres	10 1084	Conectores	2 318
Calibres para costura de soldadura	10 1096	Conos tráfico	7 815
Candados	8 922	Conos tráfico	8 971
Canteadoras	2 251	Consignación	7 809
Cargadores pilas	8 972	Contadores manuales	10 1114
Carracas	2 298	Contenedores autobasculantes	8 940
Carretillas de almacén	8 864	Contenedores basculantes para carretilla elevadora	8 939
Carro de taller	8 913	Contratuercas hexagonales y tuercas almenadas	6 615
Carros de traslación	8 853	Coronas perforadoras	3 449
Carros guías arrastre	8 855	Cortadoras cerámicas	1 212
Cartabones	10 1092	Cortafríos inoxidable	1 208
Casilleros	8 910	Cortatubos	1 165
Casquillo cónico	3 441	Cortavarillas	1 173
Cepillería industrial	4 489	Corte por plasma	5 541
Cepillos	2 256	Cronómetros	10 1114
Cestones metálicos	8 939	Crucetas, T, cuñas y Niveladores	1 213
Cierres	8 926	Cubos de basura	8 974
		Cubos y Capazos	1 214
		Cuchillas	1 229

Cuerdas	8 837
Curvadora de perfiles	2 350
Curvadoras	2 349
Cutters	1 229
Cuña anti-chispa	1 200
Cuñas	1 200
Césped artificial	9 987

D	PÁG.
----------	-------------

Decapadores	2 265
Depósitos	8 941
Depósitos de aire	2 373
Desatascador	9 1047
Desbarbadoras	2 306
Desenconfadores	1 221
Desengrasantes	9 999
Deshumidificadores de aire	2 377
Desmoldeantes	9 989
Destornilladores	1 111
Destornilladores dinamométricos	1 109
Detectores de fugas	9 988
Detectores de grietas	9 987
Detectores digitales	10 1115
Dinamómetros	8 857
Discos de corte	4 495
Discos de desbaste	4 501
Discos de diamante	4 495
Dispensadores	9 1053
Dispensadores de aceite con bomba neumática	9 1055
Dispensadores de valvolina	9 1056
Ducha y lava-ojos	7 794

E	PÁG.
----------	-------------

Electrodos	5 547
Electrodos de tungsteno	5 546
Enchufes rápidos	2 317
Engrasadores	9 1050
Enrolladores	2 315
Enrolladores automáticos	8 963
Equilibradores	2 315
Equipos motorizados y suministro de aire, gama modular	7 801
Equipos neumáticos de engrase	9 1054
Escaleras	8 948
Escariadores	3 396
Escobas	8 974
Escuadras	10 1089
Eslingas de poliéster	8 858
Esmeriladoras	2 337
Espejos	1 185
Espigas Sujeción	3 441
Espirales	2 315
Espumas poliuretano	9 1014
Espátulas	1 226
Estanterías. Cargas ligeras	8 942
Estantes clasificadores apilables	8 937
Estuches separadores fijos y móviles	8 934
Estufas	5 542
Extensibles de cable	8 965
Extinción	9 1011
Extractores	1 173
Extractores de filtros	1 184
Extractores de rótulas	1 183
Extractores de tornillos rotos	1 182

F

PÁG.

Fijación de roscas	9 982
Flexómetros	10 1104
Focos LED	8 966
Fontanería	1 166
Fontanería	5 527
Formones	1 217
Fregadoras	2 290
Fregadoras-Pulidoras	2 289
Fregonas	8 975
Fresadoras	2 263
Fresadoras / Taladros fresadores	2 329
Fresas de metal duro con mango	3 406
Fresas frontales mango cilíndrico	3 413
Fresas frontales mango cilíndrico de debastar	3 418
Fresas huecas	3 420

G

PÁG.

Gala Cleaner	5 540
Garras elevadoras	8 845
Gatos de cremallera	8 856
Gatos hidráulicos	8 858
Gavetas de plástico	8 936
Generadores de aire caliente	2 375
Giramachos	3 400
Goniómetro	10 1093
Granetes	1 210
Grapadoras y clavadoras	8 903
Grapas y clips	6 577
Grasas	9 1043
Grasas y Aceites	9 1046
Grifas	1 221
Grilletes de alta resistencia	8 836
Grupos electrógenos	2 360
Grúas	8 861
Guardallaves	8 929

H

PÁG.

Hachas	1 220
Herramienta multiuso	1 151
Herramientas de lijar	4 463
Herramientas de pulir	4 472
Herramientas de vellón	4 467
Hojas de sierra de calar	3 442
Hojas de sierra de mano	3 441
Hornos para secado de electrodos	5 542
Husillos para coronas bimetálicas	3 448

I

PÁG.

Iluminación	8 971
Imanes	8 847
Impulsión pólvora	6 578
Ingletadoras	2 254
Inverter	5 532

J

PÁG.

Jabones y toallitas	8 975
Juego de fresas frontales mango cilíndrico	3 419
Juego de fresas frontales mango cilíndrico. Desbaste	3 419
Juegos de abecedarios	10 1098
Juegos de galgas	10 1097
Juegos de galgas de espesores	10 1096
Juegos de llaves de vaso	1 76
Juegos de numeraciones	10 1097
Juegos de rotular	10 1097
Juegos machos	3 397
Juntas sellado de bridas	9 982

L	PÁG.
Lijadora excéntrica	2 260
Lijadora para tubos	2 261
Lijadoras	2 258
Lijadoras de banda	2 261
Lijadoras de banda-Biseladoras	2 337
Lijadoras de soldadura	2 274
Lijadoras excéntricas	2 273
Lijadoras orbitales	2 259
Limas	1 194
Limas y Sierras	2 307
Limpiadoras alta presión	2 287
Limpiadores	9 990
Linternas	8 970
Linternas LED	8 969
Llanas	1 225
Llave para armarios de control	1 131
Llaves ajustables	1 22
Llaves allen	1 45
Llaves combinadas	1 30
Llaves de apriete	1 24
Llaves de estrella	1 28
Llaves de golpe	1 39
Llaves de impacto	2 295
Llaves de pipa	1 38
Llaves de tubo	1 37
Llaves de vaso 1/2"	1 68
Llaves de vaso 1/4"	1 53
Llaves de vaso 1"	1 87
Llaves de vaso 3/4"	1 81
Llaves de vaso 3/8"	1 61
Llaves dinamométricas	1 101
Llaves fontanería	1 164
Llaves planas	1 25
Lubricante industria alimentaria	9 1042
Lubricantes	9 1034
Lubricantes en aerosol	9 1038
Luxómetros	10 1116
Lámparas LED	8 968
Lápiz grabador	2 312

M	PÁG.
Macetas	1 198
Machos de mano	3 397
Machos de máquina	3 401
Maletas de herramientas	8 930
Mangueras de caucho	9 1069
Manorreductores	5 528
Manta ignífuga	7 640
Maquinaria construcción	2 351
Martillos	1 202
Martillos	2 237
Martillos, cinceles y pisones	2 310
Mazas	1 198
Mazas de goma	1 204
Medidores	10 1115
Medidores de humedad	10 1115
Mesas elevadoras	8 861
Micrómetros	10 1088
Mini Lijadoras	2 305
Miniamoladoras	2 241
Mordazas	1 167
Mordazas	2 330
Mordazas rápidas	1 191
Muelas	4 456
Multi-herramienta batería	2 277
Multi-herramientas	2 257
Multiplicadores de par	1 111
Multímetros	10 1120

N	PÁG.
Navajas	1 152
Niveles	10 1101
Niveles láser	10 1112

P	PÁG.
Palas	1 218
Paletas	1 221
Paletas / Paletinas	1 223
Palotes	1 220
Paneles perforados	8 907
Pantalla de soldadura	7 637
Pastas reparadoras	9 1018
Peines	1 225
Perfiles	8 947
Perforadores	1 215
Picachones	1 218
Pilas	8 971
Pintura y marcaje	9 990
Pinturas para tiralíneas	1 213
Pinzas	1 193
Pinzas amperimétricas	10 1118
Pistolas	9 1016
Pistolas de encolar	2 265
Pistolas para sellantes	2 278
Planchas de goma	9 1079
Plantillas de radios	10 1096
Plantillas para afilado	10 1096
Plaquitas	3 420
Plataforma elevadora	8 862
Plegadoras de chapa	2 348
Plomadas	1 214
Polipastos eléctricos	8 850
Polipastos manuales	8 847
Polipastos neumáticos	8 852
Porta-Plaquitas	3 438
Prensas taller	8 860
Protecciones maquinaria para torno	2 342
Protecciones parking	7 811
Protección anticaídas	7 781
Protección auditiva. Orejeras	7 806
Protección auditiva. Tapones	7 804

Protección de cabeza	7 630
Protección de las manos. Guantes alimentación	7 709
Protección de las manos. Guantes anticorte	7 736
Protección de las manos. Guantes cuero	7 727
Protección de las manos. Guantes desechables	7 705
Protección de las manos. Guantes mecánicos	7 716
Protección de las manos. Guantes químicos	7 712
Protección de las manos. Guantes soldador	7 743
Protección de las manos. Guantes térmicos	7 743
Protección de los pies	7 747
Protección de los pies. Alimentacion	7 776
Protección de los pies. Complementos	7 762
Protección de los pies. Gore-Tex	7 776
Protección de los pies. Uniformidad	7 762
Protección facial	7 635
Protección medio ambiente	8 941
Protección ocular	7 641
Protección respiratoria. Detectores	7 800
Protección respiratoria. Filtros	7 798
Protección respiratoria. Mascarillas	7 794
Pulidoras	2 262
Pulverizadores	2 292
Puntales	1 213
Puntas de acero	6 581
Puntas de atornillador	1 120
Punteros	1 209
Punzonadoras	2 252
Purificadores / Reguladores	2 316

R	PÁG.
Racores	2 319
Racores	9 1073
Raederas	1 220
Recubrimientos	9 995
Reglas	10 1091
Relojes comparadores	10 1087
Remachadoras	1 168

Remachadoras	2 284
Remaches	6 550
Reparadores de roscas	3 405
Retención	9 983
Revestimientos	9 1011
Rodeles	1 212
Rodillos	8 856
Rodillos de lija	4 466
Roedoras	2 283
Ropa laboral. Anti-corte	7 702
Ropa laboral. Bermudas	7 659
Ropa laboral. Buzos	7 648
Ropa laboral. Camisetas y Polos	7 663
Ropa laboral. Cazadoras	7 675
Ropa laboral. Cazadoras / Pantalones / Polos	7 657
Ropa laboral. Chalecos	7 669
Ropa laboral. Chaquetas	7 674
Ropa laboral. Ergonómicos	7 703
Ropa laboral. Pantalones	7 649
Ropa laboral. Parkas	7 673
Ropa laboral. Polares / Jerseys	7 678
Ropa laboral. Ropa alta visibilidad	7 689
Ropa laboral. Ropa alta visibilidad	7 689
Ropa laboral. Ropa alta visibilidad	7 690
Ropa laboral. Ropa alta visibilidad	7 690
Ropa laboral. Ropa alta visibilidad	7 690
Ropa laboral. Ropa alta visibilidad	7 690
Ropa laboral. Ropa antiácido / Ropa de soldar	7 702
Ropa laboral. Ropa desechable	7 688
Ropa laboral. Ropa ignífuga y antiestática	7 686
Ropa laboral. Ropa para agua	7 685
Ropa laboral. Ropa térmica	7 684
Roscadoras	1 167
Roscadoras	2 302
Rozadoras	2 264
Ruedas	8 865

S

PÁG.

Sacabocados	1 214
Sargentos	1 188
Satinadora inox	2 273
Satinadoras	2 262
Secadores	2 372
Selladores	9 1006
Selladores de roscas	9 982
Serrucho teflonado	3 448
Serruchos de carpintero	3 447
Señalización	7 815
Sierras circulares	2 253
Sierras circulares	2 279
Sierras de calar	2 255
Sierras de cinta bajada controlada	2 335
Sierras de cinta manual	2 332
Sierras de cinta portátil	2 333
Sierras de sable	2 256
Sierras de sable	2 281
Sierras para tubería	3 448
Siliconas	9 1002
Sistema de trincaje	8 859
Sistema MIG-MAG	5 537
Soldadores	5 526
Soldadura aerobutánica	5 526
Soldadura oxiacetilénica	5 524
Soldadura por punto	5 540
Soldadura y masilla reparadora	9 985
Sonómetros	10 1116
Soportes anti-vibratorios	2 354
Soportes para herramientas	8 907
Sujeciones magnéticas	2 359

T	PÁG.
Tacos de nylon	6 551
Tacos de plástico / nylon	6 550
Tacómetros	10 1117
Taladro magnético	2 235
Taladros	2 234
Taladros atornilladores	2 266
Taladros de sobremesa y columna	2 324
Taladros fresadores	2 325
Taladros percutores	2 236
Taladros transmisión por correa	2 321
Taladros transmisión por correa y engranaje	2 320
Taladros transmisión por engranajes	2 320
Talochas	1 226
Taquillas	8 909
Telescómetros	10 1113
Tenacillas	1 162
Tenazas	1 156
Tenazas	1 158
Termómetros	10 1123
Terrajas de roscar	3 399
Tijeras	1 155
Tijeras electricista	1 146
Topómetros	10 1113
Tornillería Allen. Espárragos	6 599
Tornillería Allen. Métrica	6 595
Tornillería Allen. Rosca métrica	6 596
Tornillería hexagonal. Métrica	6 589
Tornillería metal. Métrica	6 603
Tornillería rosca chapa	6 607
Tornillería rosca chapa. Phillips	6 605
Tornillos de banco	1 186
Tornillos de sobremesa	1 187
Tornillos madera y aglomerado	6 610
Tornillos varios	6 613
Tornos con bancada	2 342
Tornos de sobremesa	2 340
Torres móviles	8 957

Transformadores de soldadura de arco	5 537
Transpaletas	8 863
Transportadores	10 1092
Trapos de limpieza	8 976
Trazadores	10 1100
Tubería flexible	9 1059
Tubos flexibles para lanzas refrigerantes	2 359
Tuercas hexagonales	6 614
Tuercas rápidas	6 617
Tuercas varias	6 616

U	PÁG.
Unión estructural	9 984
Unión instantánea	9 984

V	PÁG.
Vasos de impacto 1.1/2"	1 100
Vasos de impacto 1/2"	1 91
Vasos de impacto 1/4"	1 88
Vasos de impacto 1"	1 97
Vasos de impacto 3/4"	1 94
Vasos de impacto 3/8"	1 89
Ventilación	2 374
Ventosas	2 312



22
Llaves
ajustables



111
Destornilladores



163
Llaves
Stillson



25
Llaves
fijas



120
Puntas
de atornillador



165
Cortatubos



27
Llaves
de estrella



129
Puntas
de atornillador



167
Tenazas
grip



37
Llaves
de tubo



137
Alicates
pelacables



168
Remachadoras



39
Llaves
de golpe

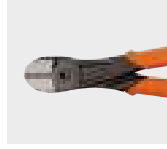

140
Alicates
corte

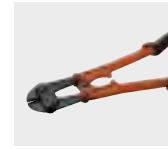

172
Cortavarillas



45
Llaves
allen



144
Alicates
cortacables

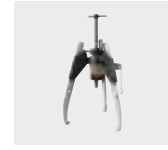

184
Extractores



53
Llaves
de vaso



147
Alicates
para arandelas



185
Espejos



88
Vasos
de impacto



151
Herramientas
multiuso



186
Tornillos
de banco



101
Dinamométricas



151
Tijeras



188
Sargentos



109
Destornillador
dinamométrico



155
Tenazas



194
Limas



110
Multiplicadores
de par

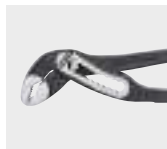

158
Tenazas
llave



198
Mazas



201
Martillos



205
Cinceles



209
Granetes



211
Sacabocados



212
Cortadoras



215
Perforadores
de chapa



217
Formones



218
Palas



219
Azadas



220
Hachas



221
Paletas

HERRAMIENTA | 01 MANUAL

91C - Llave ajustable de moleta lateral



UNE 16532 · ISO 6787 · DIN 3117. Dureza: 40 ÷ 45 HRC. Recubrimiento cromado.

Ref.	Código	A mm	B mm	C mm	D mm	€ / u.
1200100	91C	155	21	6,5	12	27,40
1200101	92C	205	29	8	14	31,24
1200102	93C	255	34	9	17	37,07
1200103	94C	305	39	10	20	47,37
1200104	95C	405	49	14	26	79,28
1200105	96C	500	62	17	30	150,69
1200106	97C	750	77	23	37	294,44

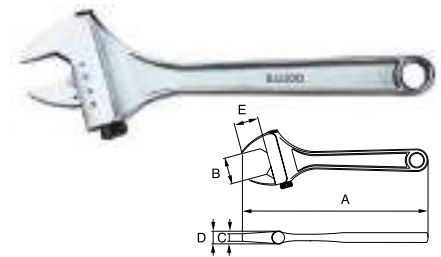

54-Llave ajustable de moleta lateral



UNE 16532 · ISO 6787 · DIN 3117. Dureza: 40 ÷ 45 HRC. Recubrimiento cromado.

Ref.	Código	Longitud mm	Longitud "	Apertura mm	€ / u.
8004627	54-6	150	6	23,9	25,38
8004628	54-8	200	8	28,6	28,50
8004629	54-10	250	10	32,8	35,63
8004630	54-12	300	12	38,1	44,25
8004631	54-15	400	15	50	75,50



771 - Llave ajustable de moleta lateral



Ref.	Código	Apertura mm	Medida	Ancho mm	Grosor mm	Grosor boca mm	€ / u.
21056000	81000 06	21	155mm-6"	51	11,5	5,3	29,14
21056001	81000 08	29	205mm-8"	67	13	6	32,67
21056002	81000 10	34	255mm-10"	79	15,5	8,6	40,26
21056003	81000 12	39	305mm-12"	93	18	11,9	51,84
21056004	81000 16	48	405mm-16"	116	21,5	13	85,63
21056005	81000 20	62	500mm-20"	129,5	30	17	141,46
21056006	81003 30	78	750mm-30"	160	37	23	311,91



92W - Llave ajustable de moleta central



Ref.	Código	Medida	Apertura mm	€ / u.
1494005	570100004005106	115mm- 4"	13	17,60
1496005	570500006005106	161mm- 6"	24	18,52
1498005	570500008005106	207mm- 8"	30	21,25
1490005	570500010005106	259mm-10"	34	26,21
1492005	570500012005103	311mm-12"	39	34,75
1495005	570100015008103	386mm-15"	43	58,87
1508005	570100018008103	462mm- 18"	53	91,64



8069 C IP - Llave ajustable de moleta central



UNE 16532 · ISO 6787 · DIN 3117. Dureza: 40 ÷ 45 HRC. Recubrimiento cromado.

Ref.	Código	A mm	B mm	C mm	D mm	€ / u.
1200000	8069 C IP	110	13	4.0	9.0	15,90
1200001	8070 C IP	155	20	4.9	11.5	16,31
1200002	8071 C IP	205	27	6.0	13.0	18,65
1200003	8072 C IP	255	30	8.6	15.5	22,71
1200004	8073 C IP	305	34	11.9	18.0	30,04
1200005	8074 C IP	380	44	14.0	20.0	50,80
1200006	8075 C IP	455	53	17.7	22.5	79,13

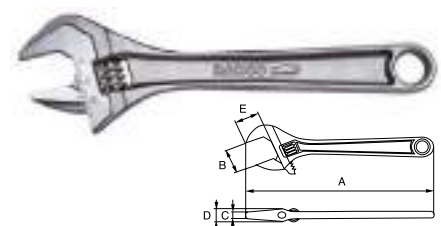

9029-T/9031-T - Llave ajustable moleta central, gran apertura, mordazas extra finas



Llave ajustable diseñada según los procesos científicos ERGO™. Llaves ajustables especiales de 6" y 8" con una amplia apertura. Según: ISO 6787, DIN 3117, ASME B107.8M-2003 y BS 6333. Aleación de acero de alto rendimiento. Mango cómodo y antideslizante termoplástico. Escala en mm para prefijar y realizar mediciones precisas. La mordaza no se cae incluso a máxima apertura de la llave. Apertura un 40% más amplia comparada con una llave ajustable normal. Mordazas un 45% más finas comparada con una llave ajustable normal. Más ligera con una medida perfecta del mango. La cabeza pequeña y robusta ofrece excelente accesibilidad y magníficas prestaciones. Perfecta para fontaneros y otros trabajadores que llevan sus propias herramientas. Tornillo a izquierdas.

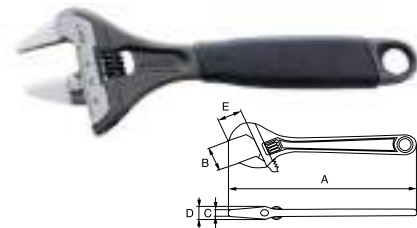

Ref.	Código	A mm	B mm	C mm	D mm	€ / u.
1200365	9029-T	170	32	4.5	12	35,20
1200366	9031-T	18	38	4.5	13	40,96

SWO 92 - Llave ajustable moleta central, gran apertura



Ref.	Código	Medida	Apertura mm	€ / u.
1496008	570308006008105	176mm-6"	34	32,80
1498008	570308008008105	216mm-8"	39	35,66
2400062	570310010005105	264mm-10"	53	47,07



9029C/9031C - Llave ajustable moleta central, con apertura de mordaza extra ancha



Llave ajustable diseñada según los procesos científicos ERGO™. Llave ajustable especial con apertura de mordaza extra ancha. Según: ISO 6787, DIN 3117, ASME B107.8M-2003 y BS 6333. Aleación de acero de alto rendimiento. Mango cómodo y antideslizante termoplástico. Escala en mm para prefijar y realizar mediciones precisas. La mordaza no se cae incluso a máxima apertura de la llave. Apertura un 40% más amplia comparada con una llave ajustable normal y más ligera con una medida perfecta del mango. La cabeza pequeña y robusta ofrece excelente accesibilidad y magníficas prestaciones. Perfecta para fontaneros y otros trabajadores que llevan sus propias herramientas. Tornillo a izquierdas. Cromada, templado de precisión y tratamiento anti-corrosión.

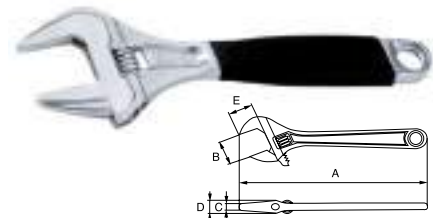

Ref.	Código	A mm	B mm	C mm	D mm	€ / u.
1200370	9029 C	170	32	5	12	35,78
1200371	9031 C	218	38	6	13	38,37

SWO 92XS - Llave ajustable moleta central, gran apertura, bocas extrafinas



Ref.	Código	Medida	Apertura mm	Longitud mm	€ / u.
1200375	570909006005105	6"	34	176	36,42
1200376	570909008005105	8"	39	216	39,91



92LW - Llave ajustable moleta central, light weight



Ref.	Código	Medida	Ancho mm	Grosor mm	€ / u.
21056007	571822006005130	161mm-6"	24	10,8	26,12
21056008	571822008005130	207mm-8"	30	14	30,10
21056009	571822010005130	259mm-10"	36	15,8	36,23
21056010	571822012005130	311mm-12"	46	19	47,34



92 WR Llave ajustable moleta central, boca reversible



Ref.	Código	Medida	Apertura mm	Longitud	€ / u.
1200380	571101006005306	6"	27	161	23,79
1200381	571101008005306	8"	34	207	26,91
1200382	571101010005306	10"	40	259	32,38
1200383	571101012005303	12"	45	311	42,26



TAH- Llave ajustable moleta central para trabajos en altura



Ref.	Código	Medida	€ / u.
2400144	TAH9070	6"	44,59
2400145	TAH9072	10"	63,04

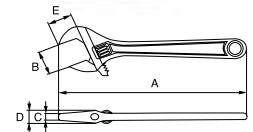

8070V - Llave ajustable moleta central, aislada



Ref.	Código	A mm	B mm	C mm	D mm	€ / u.
1244000	8070V	150	20	5.5	12	39,14
1244001	8071V	200	24	7.5	13.5	47,59
1244002	8072V	250	29	9	16	53,05
1244003	8073V	300	36	11	19	70,38
1244004	8074V	375	43	13	24	113,80

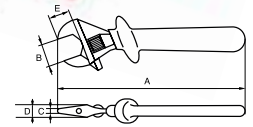

SS001 - Llave ajustable moleta central, acero inoxidable



Ref.	Código	A mm	B mm	C mm	D mm	€ / u.
2400146	SS001-100	100	13	10	7	90,91
2400147	SS001-150	150	18	8	13	102,46
2400148	SS001-200	200	24	9	15	149,23
2400149	SS001-250	250	30	10	116	184,27
2400150	SS001-300	300	36	11	19	243,99
2400151	SS001-375	375	46	14	24	378,88
2400152	SS001-450	450	55	15	27	447,81
2400153	SS001-600	600	60	20	33	750,62

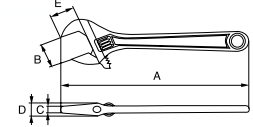

111INOX - Llave ajustable moleta central, acero inoxidable



- Alta resistencia a la corrosión • Características mecánicas sobresalientes • Evita la oxidación incorrecta
- Acero inoxidable AISI 420

Ref.	Código	L mm	L "	A max mm	A1 mm	€ / u.
8005125	1110315	150	6	18	45	117,50
8005126	1110320	200	8	24	58	144,50
8005127	1110325	250	10	30	70	175,00

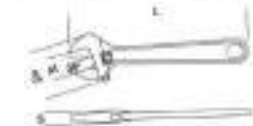

Llave ajustable moleta central, antichispa



Ref.	Código	Modelo	Longitud	Longitud mm	Apertura mm	Apertura "	€ / u.
1200815	AT0150A	W-70	6"	150	19	3/4"	134,82
1200816	AT0200A	W-71	8"	200	25	1"	153,63
1200817	AT0250A	W-72	10"	250	30	1 3/16"	206,60
1200818	AT0300A	W-73	12"	300	36	1 3/8"	263,25
1200819	AT0380A	W-74	15"	380	44	1 3/4"	483,29
1200820	AT0460A	W-75	18"	450	55	2 3/16"	637,11
1200821	AT0600A	W-76	24"	600	65	2 9/16"	1.047,25



Llave fija de dos bocas



Acero de cromo-vanadio. Cromado mate. Forjado.
Posición de la boca con un ángulo de 15°.
DIN 3110, ISO 3318, ISO 1085, ISO 10102.



Ref.	Código	Entrecaras mm	L mm	€ / u.	Ref.	Código	Entrecaras mm	L mm	€ / u.
8004632	M456906073	6x7	125	2,90	8004639	M456920223	20x22	230	11,30
8004633	M456908093	8x9	138	3,90	8004640	M456921233	21x23	240	12,15
8004634	M456910113	10x11	155	4,30	8004641	M456924263	24x26	260	14,45
8004635	M456912133	12x13	170	5,15	8004642	M456924273	24x27	260	12,95
8004636	M456914153	14x15	188	6,45	8004643	M456925283	25x28	275	14,55
8004637	M456916173	16x17	200	8,40	8004644	M456927293	27x29	295	22,95
8004638	M456918193	18x19	215	8,90	8004645	M456930323	30x32	315	20,45

6M - Llave fija de dos bocas



ISO 691 - 1085 - 10102 -
3318. Dureza: 44 ÷ 50 HRC.
Recubrimiento cromado

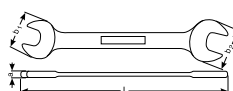

Ref.	Código	Entrecaras mm	A mm	b1 mm	b2 mm	L mm	€ / u.	Ref.	Código	Entrecaras mm	A mm	b1 mm	b2 mm	L mm	€ / u.
1200400	6M-4-5	4x5	3.2	13.0	15.0	105	5,44	1200419	6M-20-22	20x22	7.2	42.0	43.0	225	11,91
1200401	6M-5-7	5.5x7	3.9	15.5	17.9	122	5,45	1200420	6M-21-23	21x23	7.4	45.0	49.0	240	12,98
1200402	6M-6-7	6x7	3.9	15.5	17.9	122	5,45	1200421	6M-22-24	22x24	7.4	45.0	49.0	240	12,96
1200403	6M-7-8	7x8	3.9	15.5	17.9	122	5,78	1200422	6M-24-26	24x26	7.8	49.0	53.0	260	15,08
1200404	6M-8-9	8x9	4.0	18.7	21.2	138	5,48	1200423	6M-24-27	24x27	7.8	49.0	53.0	260	15,37
1200405	6M-8-10	8x10	4.0	18.7	21.2	138	5,89	1200424	6M-25-28	25x28	8.4	53.0	58.0	280	17,52
1200406	6M-10-11	10x11	5.2	23.0	24.9	153	5,96	1200426	6M-27-30	27x30	8.4	53.0	58.0	280	21,77
1200408	6M-10-13	10x13	5.2	23.0	24.9	153	7,32	1200427	6M-27-32	27x32	9.0	60.0	67.0	300	23,82
1200409	6M-12-13	12x13	5.8	28.7	30.5	168	7,25	1200428	6M-30-32	30x32	9.0	60.0	67.0	300	23,52
1200412	6M-13-17	13x17	6.3	30.1	32.1	183	9,07	1200429	6M-32-36	32x36	11.0	66.0	74.0	355	41,17
1200413	6M-14-15	14x15	6.3	30.1	32.1	183	7,69	1200430	6M-34-36	34x36	11.0	66.0	74.0	355	43,22
1200415	6M-16-17	16x17	7.0	34.7	35.6	201	8,92	1200431	6M-36-41	36x41	11.5	74.0	83.0	385	46,93
1200416	6M-17-19	17x19	7.3	37.4	40.5	222	10,05	1200432	6M-41-46	41x46	13.3	85.0	94.0	400	66,05
1200417	6M-18-19	18x19	7.3	38.1	41.2	222	10,05	1200433	6M-46-50	46x50	14.2	94.0	100.5	446	86,11
1200418	6M-19-22	19x22	7.3	42.0	46.0	225	12,16								

6Z - Llave fija de dos bocas, pulgadas



ISO 691 - 1085 - 10102 -
3318. Dureza: 44 ÷ 50 HRC.
Recubrimiento cromado.

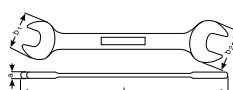

Ref.	Código	Entrecaras mm	A mm	b1 mm	b2 mm	L mm	€ / u.	Ref.	Código	Entrecaras mm	A mm	b1 mm	b2 mm	L mm	€ / u.
1200500	6Z-1/4-5/16	1/4x5/16	3.9	15.5	17.9	122	5,59	1200510	6Z-3/4-7/8	3/4x7/8	7.3	42.0	46.0	225	12,28
1200502	6Z-3/8-7/16	3/8x7/16	5.2	23.0	24.9	153	6,25	1200511	6Z-13/16-7/8	13/16x7/8	7.3	42.0	46.0	225	12,28
1200503	6Z-7/16-1/2	7/16x1/2	5.8	28.7	30.5	168	7,47	1200512	6Z-7/8-15/16	7/8x15/16	7.4	45.0	49.0	240	15,88
1200504	6Z-1/2-9/16	1/2x9/16	5.8	28.7	30.5	168	7,91	1200513	6Z-15/16-1	15/16x1	7.8	49.0	53.0	260	15,53
1200505	6Z-9/16-5/8	9/16x5/8	6.6	30.1	32.1	183	7,91	1200514	6Z-1-1/8	1x1 1/8	8.4	53.0	58.0	280	17,99
1200506	6Z-19/32-11/16	19/32x11/16	7.0	34.7	35.6	201	9,92	1200515	6Z-1 1/16-1 1/4	1.1/16x1 1/4	8.4	53.0	58.0	280	23,83
1200508	6Z-5/8-3/4	5/8x3/4	7.0	34.7	35.6	201	10,30	1200516	6Z-1 1/4-1 3/8	1.1/4x1 3/8	11.0	66.0	74.0	355	41,36
1200509	6Z-11/16-3/4	11/16x3/4	7.3	37.4	40.5	222	10,30								



Llave fija de dos bocas, antichispa

Las herramientas ENDRES son antichispas, antimagnéticas y muy resistentes a la corrosión. Se fabrican con una aleación (aluminio-bronce especial, cobre-berilio), y están homologadas por los pertinentes organismos oficiales de investigación de materiales. Los moldes y los controles de calidad de las herramientas cumplen las normas DIN. Nuestro alto nivel de calidad se consigue y mantiene gracias a dichos programas de control de calidad.



Ref.	Código	Entrecaras mm	L mm	€ / u.	Ref.	Código	Entrecaras mm	L mm	€ / u.
1280300	EN0010607S	6x7	125	53,52	1280321	EN0011719S	17x19	225	87,79
1280301	EN0010608S	6x8	125	53,52	1280322	EN0011819S	18x19	225	91,66
1280302	EN0010708S	7x8	125	53,52	1280323	EN0011820S	18x20	225	91,66
1280303	EN0010709S	7x9	125	57,35	1280324	EN0011922S	19x22	240	103,16
1280304	EN0010809S	8x9	125	57,35	1280325	EN0011924S	19x24	240	122,23
1280305	EN0010810S	8x10	125	57,35	1280326	EN0012022S	20x22	240	110,70
1280306	EN0010910S	9x10	125	57,35	1280327	EN0012123S	21x23	240	114,58
1280307	EN0010911S	9x11	140	57,35	1280328	EN0012224S	22x24	240	122,23
1280308	EN0011011S	10x11	140	61,06	1280329	EN0012227S	22x27	270	129,76
1280309	EN0011012S	10x12	140	61,06	1280330	EN0012326S	23x26	270	129,76
1280310	EN0011014S	10x14	160	64,89	1280331	EN0012426S	24x26	270	129,76
1280311	EN0011113S	11x13	160	64,89	1280332	EN0012427S	24x27	270	133,61
1280312	EN0011114S	11x14	160	64,89	1280333	EN0012430S	24x30	270	141,31
1280313	EN0011213S	12x13	160	64,89	1280334	EN0012528S	25x28	270	141,31
1280314	EN0011214S	12x14	160	64,89	1280335	EN0012629S	26x29	270	152,70
1280315	EN0011315S	13x15	160	68,74	1280336	EN0012729S	27x29	300	152,70
1280316	EN0011415S	14x15	160	68,74	1280337	EN0012730S	27x30	300	156,54
1280317	EN0011416S	14x16	200	68,74	1280338	EN0012732S	27x32	300	175,58
1280318	EN0011417S	14x17	200	72,57	1280339	EN0013032S	30x32	300	183,29
1280319	EN0011617S	16x17	200	72,57	1280340	EN0013034S	30x34	320	183,29
1280320	EN0011618S	16x18	200	72,57	1280341	EN0013036S	30x36	320	210,03

6M - Juego de llaves fijas de dos bocas



Acero de cromo-vanadio. Cromado mate. Forjado. Posición de la boca con un ángulo de 15°. DIN 3110, ISO 3318, ISO 1085, ISO 10102.

Ref.	Código	Composición	Contenido piezas	€ / u.
1200703	6M/8C	6x7, 8x9, 10x11, 12x13, 14x15, 16x17, 18x19, 20x22 mm.	8	64,30
1200704	6M/10C	6x7, 8x9, 10x11, 12x13, 14x15, 16x17, 18x19, 20x22, 24x27, 30x32 mm.	10	93,07
1200706	6M/12C	6x7, 8x9, 10x11, 12x13, 14x15, 16x17, 18x19, 20x22, 21x23, 24x27, 25x28, 30x32 mm.	12	135,38
1200900	6M/SH8	6x7, 8x9, 10x11, 12x13, 14x15, 16x17, 18x19, 20x22 mm.	8	78,45
1200901	6M/SH12	6x7, 8x9, 10x11, 12x13, 13x17, 14x15, 16x17, 18x19, 19x22, 20x22, 21x23, 24x27 mm.	12	144,95



6M/8C



6M/SH8

Juego de llaves fijas de dos bocas



Ref.	Código	Composición	Contenido piezas	€ / u.
8004646	M4569008843	6x7; 8x9; 10x11; 12x13; 14x15; 16x17; 18x19; 20x22 mm.	8	62,88
8004647	M4569012813	6x7; 8x9; 10x11; 12x13; 14x15; 16x17; 18x19; 20x22; 21x23; 24x27; 25x28; 30x32 mm 24x27; 25x28; 30x32 mm.	12	142,08



894M - Llave plana una boca



ISO 3318 · DIN 894.
Dureza: 39 ÷ 44 HRC.

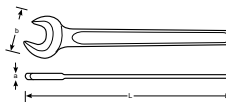

Ref.	Código	Entrecaras mm	A mm	B mm	L mm	€ / u.
1201300	894M-8	8	3.5	18	94	3,43
1201301	894M-9	9	4.0	20	100	3,52
1201302	894M-10	10	4.5	22	106	3,43
1201303	894M-11	11	5.0	24	112	3,52
1201304	894M-12	12	5.0	26	125	3,52
1201305	894M-13	13	5.0	29	125	3,52
1201306	894M-14	14	5.5	30	140	4,12
1201307	894M-15	15	5.5	32	140	4,27
1201309	894M-17	17	6.0	36	158	3,52
1201311	894M-19	19	7.0	40	171	4,78
1201313	894M-22	22	8.0	46	195	5,95
1201314	894M-24	24	9.0	50	216	7,17
1201315	894M-27	27	10.0	56	240	8,19
1201316	894M-30	30	11.0	62	262	9,65
1201317	894M-32	32	12.0	67	274	10,88

Ref.	Código	Entrecaras mm	A mm	B mm	L mm	€ / u.
1201319	894M-36	36	13.0	74	303	14,15
1201320	894M-38	38	13.0	78	305	22,06
1201321	894M-41	41	14.0	85	343	22,45
1201322	894M-46	46	15.0	94	378	25,40
1201323	894M-50	50	16.0	102	413	31,81
1201324	894M-55	55	17.0	113	457	37,58
1201325	894M-60	60	18.0	122	492	52,96
1201326	894M-65	65	19.0	132	528	63,53
1201327	894M-70	70	20.0	142	573	74,20
1201328	894M-75	75	21.0	152	608	127,79
1201329	894M-80	80	22.0	162	644	150,86
1201330	894M-85	85	23.0	174	690	184,14
1201331	894M-90	90	25.0	174	690	205,94
1201332	894M-95	95	25.0	195	850	313,27
1201333	894M-100	100	28.0	195	1.000	319,36

6MV - Llave plana una boca, aislada

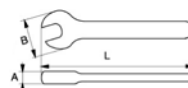

Ref.	Código	Entrecaras mm	A mm	B mm	L mm	€ / u.
1243400	6MV-6	6	3.7	15.0	92	24,09
1243401	6MV-7	7	3.7	17.5	92	24,41
1243402	6MV-8	8	4.0	18.0	92	22,18
1243403	6MV-9	9	4.0	21.0	98	23,21
1243404	6MV-10	10	5.0	24.0	108	23,48
1243405	6MV-11	11	5.0	26.0	116	23,63
1243406	6MV-12	12	5.5	28.0	125	24,81
1243407	6MV-13	13	5.5	31.0	135	26,07
1243408	6MV-14	14	6.0	31.0	140	26,07
1243409	6MV-15	15	6.0	33.0	150	25,96
1243410	6MV-16	16	6.5	34.0	157	27,35

Ref.	Código	Entrecaras mm	A mm	B mm	L mm	€ / u.
1243411	6MV-17	17	6.5	37.0	162	27,86
1243412	6MV-18	18	7.0	39.0	170	28,50
1243413	6MV-19	19	7.0	42.0	175	29,57
1243414	6MV-20	20	7.5	43.0	180	31,01
1243415	6MV-21	21	7.5	46.0	184	33,43
1243416	6MV-22	22	7.5	47.0	193	34,88
1243417	6MV-23	23	8.0	49.0	203	38,87
1243418	6MV-24	24	8.5	51.0	210	40,35
1243419	6MV-27	27	9.5	59.0	225	46,52
1243420	6MV-30	30	10.0	63.0	240	51,87
1243421	6MV-32	32	10.0	68.0	250	53,14

4M - Llave de estrella plana de dos bocas



ISO 1085 - 10103 · DIN 837. Dureza: 42 ÷ 48 HRC. Recubrimiento cromado.



Ref.	Código	Entrecaras mm	A mm	b1 mm	b2 mm	L mm	€ / u.
1201400	4M-6-7	6x7	4.7	9.9	11.2	100	9,75
1201401	4M-8-9	8x9	5.2	12.5	14.0	115	10,07
1201402	4M-10-11	10x11	6.4	15.5	16.5	130	11,19
1201403	4M-12-13	12x13	7.3	18.5	20.5	143	12,23
1201404	4M-14-15	14x15	7.3	21.0	22.5	157	13,41
1201405	4M-16-17	16x17	8.5	23.5	24.5	168	14,42

Ref.	Código	Entrecaras mm	A mm	b1 mm	b2 mm	L mm	€ / u.
1201406	4M-17-19	17x19	9.0	25.5	27.0	185	14,99
1201407	4M-18-19	18x19	9.2	26.0	27.5	189	14,99
1201408	4M-20-22	20x22	10.5	28.0	31.5	200	17,31
1201411	4M-24-27	24x27	11.0	35.0	38.0	255	21,27
1201414	4M-30-32	30x32	12.8	42.5	45.0	285	30,30

4M - Juego de llaves de estrella plana de dos bocas



Ref.	Código	Composición	Contenido piezas	€ / u.
1201501	4M/8	6x7, 8x9, 10x11, 12x13, 14x15, 16x17, 18x19, 20x22 mm.	8	120,17
1201600	4M/10T	6x7, 8x9, 10x11, 12x13, 14x15, 16x17, 18x19, 20x22, 24x27, 30x32 mm	10	178,83



4M/8



4M/10T

1320RM - Llave de estrella plana a carraca



Ref.	Código	Entrecaras mm	A mm	b1x b2 mm	L mm	€ / u.
1201700	1320RM-6-7	6x7	6.3x6.5	14.2x17.2	115	31,05
1201701	1320RM-8-9	8x9	6.5x6.9	16.8x20.2	128	31,48
1201702	1320RM-10-11	10x11	7.3x7.7	20.2x21.8	150	33,39
1201703	1320RM-12-13	12x13	8.2x8.6	23.0x24.8	170	35,61
1201704	1320RM-14-15	14x15	9.0x9.4	26.5x29.5	190	39,41
1201705	1320RM-16-17	16x17	9.9x10.3	29.5x31.5	200	43,26
1201706	1320RM-18-19	18x19	10.3x11.2	31.5x33.5	230	46,55



Juego de llave de estrella plana a carraca



Ref.	Código	Composición	Contenido piezas	€ / u.
1201800	1320RM/SH8	6x7 8x9 10x11 12x13 14x15 16x17 18x19 22x24 mm	8	317,35



Llave de carraca 4 en 1



Juego de llaves de carraca 4 en 1, dimensiones en métricas. Juego en una práctica funda para poder llevarla en el cinturón.

Ref.	Código	Composición	Contenido piezas	€ / u.
1309608	S4RM/3T	8x9-10x11 - 12x13-14x15 - 16x17-18x19	3	94,49
1309609	S4RM/4T	8x9-10x11 - 12x13-14x15 - 16x17-18x19 - 21x22-24x27	4	154,46
1309610	S4RM/5T	8x9-10x11 - 2x13-14x15 - 16x17-18x19 - 21x22-24x27 - 30x32-34x36	5	311,27



1949M - Llave para racores hexagonales



DIN 3118.
Dureza: 42 ÷ 48 HRC.
Recubrimiento cromado.

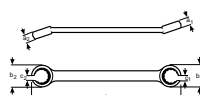

Ref.	Código	Entrecaras mm	a1x a2 mm	b1x b2 mm	c1x c2 mm	L mm	€ / u.
1202100	1949M-8-9	8x9	7.0x8	18x20	6x6.5	140	23,21
1202101	1949M-10-11	10x11	8.5x9	20x22	7x8.5	150	23,21
1202102	1949M-12-13	12x13	9.5x11	24x28	9x10	170	24,81
1202103	1949M-12-14	12x14	9.5x11	24x28	9x11	170	26,03
1202104	1949M-14-15	14x15	10.5x11	26x28	11x12	170	26,03
1202105	1949M-14-17	14x17	11.0x12	28x30	11x14	200	26,03

Ref.	Código	Entrecaras mm	a1x a2 mm	b1x b2 mm	c1x c2 mm	L mm	€ / u.
1202200	1949M-17-19	17x19	12.5x13.5	31.5x34.5	14x15	210	35,57
1202201	1949M-19-22	19x22	13.5x15.5	34.0x40.0	15x17	220	35,57
1202202	1949M-22-24	22x24	15.5x16.5	38.0x42.0	17x18	235	40,71
1202203	1949M-24-27	24x27	16.5x17.5	44.5x47.5	18x20	255	51,46
1202204	1949M-30-32	30x32	20.5x22.5	50.0x52.0	22x24	280	63,70

Llave de estrella acodada de dos bocas



Cromado mate. Forjado. Posición del anillo acodado profundo. DIN 838, ISO 3318, ISO 1085, ISO 10104. Para tuercas o tornillos muy profundos o extremadamente hundidos. Acero de cromo-vanadio.



Ref.	Código	Entrecaras mm	L mm	€ / u.
8004648	M452906073	6x7	180	5,60
8004649	M452908093	8x9	195	6,30
8004650	M452910113	10x11	205	7,80
8004651	M452912133	12x13	225	8,35
8004652	M452914153	14x15	235	9,15
8004653	M452916173	16x17	255	10,05
8004654	M452918193	18x19	295	14,90

Ref.	Código	Entrecaras mm	L mm	€ / u.
8004655	M452920223	20x22	305	20,15
8004656	M452921233	21x23	320	22,35
8004657	M452924263	24x26	340	25,85
8004658	M452924273	24x27	340	23,60
8004659	M452925283	25x28	350	34,30
8004660	M452927293	27x29	355	36,40
8004661	M452930323	30x32	370	35,70



2M - Llave de estrella acodada de dos bocas



ISO 1085 - 10104 · DIN 838. Dureza: 42 ÷ 48 HRC. Recubrimiento cromado.

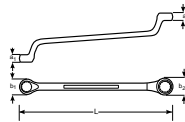

Ref.	Código	Entrecaras mm	a1x a2 mm	b1x b2 mm	L mm	€/ u.
1202501	2M-8-9	8x9	6.0x6.5	13.0x14.5	180	11,37
1202502	2M-10-11	10x11	7.0x7.5	16.1x18.1	190	12,03
1202503	2M-12-13	12x13	8.0x8.5	18.7x20.8	210	12,93
1202504	2M-13-17	13x17	9.5x10.0	20.8x27.0	243	14,11
1202505	2M-14-15	14x15	8.5x9.5	22.5x24.5	226	13,71

Ref.	Código	Entrecaras mm	a1x a2 mm	b1x b2 mm	L mm	€/ u.
1202506	2M-16-17	16x17	9.5x10.0	25.0x27.0	246	16,38
1202507	2M-17-19	17x19	10.5x11.0	27.5x29.5	266	19,09
1202509	2M-18-19	18x19	10.5x11.0	27.5x29.5	266	19,09
1202510	2M-19-22	19x22	11.5x12.0	30.6x33.7	291	22,57
1202511	2M-20-22	20x22	11.5x12.0	30.6x33.7	291	23,42

2Z - Llave de estrella acodada de dos bocas, pulgadas



ISO 1085 - 10104 · DIN 838. Dureza: 42 ÷ 48 HRC. Recubrimiento cromado.

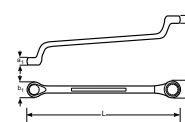

Ref.	Código	Entrecaras "	a1x a2 mm	b1x b2 mm	L mm	€/ u.
1202600	2Z-1/4-5/16	1/4x5/16	5x6	10.5x12	165	11,85
1202601	2Z-5/16-3/8	5/16x3/8	6x6.5	13x14.5	180	11,58
1202602	2Z-3/8-7/16	3/8x7/16	7x7.5	16.1x18.1	190	13,25
1202604	2Z-1/2-9/16	1/2x9/16	8x8.5	18.7x22.5	210	13,15
1202605	2Z-9/16-5/8	9/16x5/8	8.5x9.5	22.5x24.5	225.8	14,11
1202606	2Z-5/8-11/16	5/8x11/16	9.5x10	25x27	245.5	16,81

Ref.	Código	Entrecaras "	a1x a2 mm	b1x b2 mm	L mm	€/ u.
1202610	2Z-3/4-7/8	3/4x7/8	11.5x12	30.6x33.7	290.5	22,57
1202611	2Z-13/16-7/8	13/16x7/8	12x30	30.6x33.7	290.5	22,57
1202613	2Z-15/16-1	15/16x1	13x14	35.75x40	325.8	31,08
1202614	2Z-1-1/8	1x1.1/8	13.5x14.5	37.8x43	335.9	36,83
1202615	2Z-11/16-11/4	1.1/16x1.1/4	14x16	42x49.5	353	40,75

2MV - Llave de estrella acodada de una boca, aislada

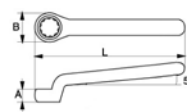

Ref.	Código	A mm	B mm	L mm	€/ u.
1243500	2MV-8	6.0	13.0	150	30,22
1243501	2MV-9	6.5	14.5	155	30,82
1243502	2MV-10	7.0	16.0	160	30,73
1243503	2MV-11	7.5	18.0	170	31,01
1243504	2MV-12	8.0	18.5	180	31,01

Ref.	Código	A mm	B mm	L mm	€/ u.
1243505	2MV-13	8.5	20.5	180	33,26
1243506	2MV-17	10.0	26.5	205	37,05
1243507	2MV-19	11.0	29.0	225	38,97
1243508	2MV-22	12.0	33.0	245	41,32

Llave de estrella acodada de dos bocas, antichispa



Las herramientas ENDRES son antichispas, antimagnéticas y muy resistentes a la corrosión. Se fabrican con una aleación [aluminio-bronce especial, cobre-berilio], y están homologadas por los pertinentes organismos oficiales de investigación de materiales. Los moldes y los controles de calidad de las herramientas cumplen las normas DIN. Nuestro alto nivel de calidad se consigue y mantiene gracias a dichos programas de control de calidad.

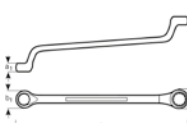

Ref.	Código	Entrecaras mm	L mm	€/ u.
1280400	EN0110607S	6 x 7	170	68,74
1280401	EN0110608S	6 x 8	170	72,57
1280402	EN0110708S	7 x 8	170	75,28
1280403	EN0110709S	7 x 9	170	75,28
1280404	EN0110809S	8 x 9	170	72,57
1280405	EN0110810S	8 x 10	180	72,57
1280406	EN0110910S	9 x 10	180	76,43
1280407	EN0110911S	9 x 11	180	76,43
1280408	EN0111011S	10 x 11	180	76,43
1280409	EN0111012S	10 x 12	180	83,94
1280410	EN0111014S	10 x 14	195	83,94
1280411	EN0111113S	11 x 13	195	83,94
1280412	EN0111114S	11 x 14	195	83,94
1280413	EN0111213S	12 x 13	195	83,94
1280414	EN0111214S	12 x 14	195	94,70
1280415	EN0111315S	13 x 15	230	94,70
1280416	EN0111415S	14 x 15	230	94,70
1280417	EN0111416S	14 x 16	230	102,33
1280418	EN0111417S	14 x 17	230	99,35
1280419	EN0111617S	16 x 17	230	99,35
1280420	EN0111618S	16 x 18	280	106,87

Ref.	Código	Entrecaras mm	L mm	€/ u.
1280421	EN0111719S	17 x 19	280	114,58
1280422	EN0111819S	18 x 19	280	142,08
1280423	EN0111820S	18 x 20	280	142,08
1280424	EN0111922S	19 x 22	280	142,08
1280425	EN0111924S	19 x 24	290	151,28
1280426	EN0112022S	20 x 22	280	142,08
1280427	EN0112123S	21 x 23	290	145,17
1280428	EN0112224S	22 x 24	300	157,85
1280429	EN0112227S	22 x 27	330	182,82
1280430	EN0112326S	23 x 26	330	182,82
1280431	EN0112426S	24 x 26	330	182,82
1280432	EN0112427S	24 x 27	330	182,82
1280433	EN0112430S	24 x 30	330	232,97
1280434	EN0112528S	25 x 28	330	213,72
1280435	EN0112629S	26 x 29	370	213,72
1280436	EN0112729S	27 x 29	370	213,72
1280437	EN0112730S	27 x 30	370	232,97
1280438	EN0112732S	27 x 32	370	240,46
1280439	EN0113032S	30 x 32	370	252,04
1280440	EN0113036S	30 x 36	430	324,49



2M - Juego de llaves de estrella acodadas de dos bocas



Ref.	Código	Composición	Contenido piezas	€ / u.
1202701	2M/S8	6x7, 8x9, 10x11, 12x13, 14x15, 16x17, 18x19, 20x22	8	117,86
1202800	2M/8T	6x7, 8x9, 10x11, 12x13, 14x15, 16x17, 18x19, 20x22	8	122,05
1202801	2M/12T	6x7, 8x9, 10x11, 12x13, 14x15, 16x17, 18x19, 20x22, 21x23, 24x26, 25x28, 30x32 6x7, 8x9, 10x11, 12x13, 14x15, 16x17, 18x19, 20x22, 21x23, 24x26, 25x28, 30x32	12	259,43



2M/S8



2M/8T

Juego de llaves de estrella acodadas de dos bocas



Ref.	Código	Composición	Contenido piezas	€ / u.
8004662	M4529008863	6x7; 8x9; 10x11; 12x13; 14x15; 16x17; 18x19; 20x22 mm	8	102,84
8004663	M452901203	6x7; 8x9; 10x11; 12x13; 14x15; 16x17; 18x19; 20x22; 21x23; 24x27; 25x28; 30x32 mm	12	246,18



1943M™ - Llave de media luna



Ref.	Código	Entrecaras mm	a1x a2 mm	b1x b2 mm	L mm	€ / u.
1202300	1943M-11-13	11x13	7.0x7.5	17.0x19.5	150	27,99
1202301	1943M-14-17	14x17	8.5x9.0	21.5x25.0	185	32,09
1202302	1943M-19-22	19x22	11.5x12.0	28.5x32.0	235	34,34

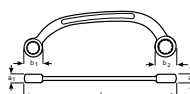

Llave combinada Joker



Ref.	Código	Entrecaras mm	€ / u.
1373268	05073268001	8	32,01
1373270	05073270001	10	32,01
1373271	05073271001	11	35,64
1373272	05073272001	12	35,64
1373273	05073273001	13	35,79
1373274	05073274001	14	44,57

Ref.	Código	Entrecaras mm	€ / u.
1373275	05073275001	15	45,22
1373276	05073276001	16	45,22
1373277	05073277001	17	45,81
1373278	05073278001	18	51,48
1373279	05073279001	19	51,64

Juego llaves combinadas Joker



Ref.	Código	Descripción	€ / u.
1370020	05073290001	10 - 13 - 17 - 19	157,33
8000001	05020013001	8 - 10 - 11 - 12 - 13 - 14 - 15 - 16 - 17 - 18 - 19	448,71



Llave combinada



01

Cromado mate. Forjado. Posición de la boca y del anillo con un ángulo de 15°.
DIN 3113 A, ISO 3318, ISO 7738. Acero de cromo-vanadio.



Ref.	Código	Entrecaras mm	L mm	€/ u.
8004664	M452301303	13	170	7,20
8004665	M452301403	14	180	7,36
8004666	M452301503	15	190	8,00
8004667	M452301603	16	190	8,56
8004668	M452301703	17	210	9,52
8004669	M452301803	18	220	12,48
8004670	M452301903	19	230	12,48

Ref.	Código	Entrecaras mm	L mm	€/ u.
8004671	M452302003	20	250	14,56
8004672	M452302103	21	250	14,56
8004673	M452302203	22	270	17,76
8004674	M452302403	24	290	21,20
8004675	M452302703	27	310	25,04
8004676	M452303003	30	340	29,20
8004677	M452303203	32	370	32,64

111M - Llave combinada



ISO 691 - 7738 -3318 - 1711-1 · DIN 3113.

Dureza: 44 ÷ 50 HRC.

Recubrimiento cromado.

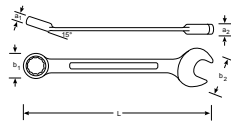

Ref.	Código	Entrecaras mm	a1x a2 mm	b1x b2 mm	L mm	€/ u.
1203000	111M-6	6	5.0x3.7	10.0x14.3	112	5,81
1203001	111M-7	7	5.3x3.8	11.7x17.1	120	5,87
1203002	111M-8	8	5.8x4.2	12.8x19.0	130	6,04
1203003	111M-9	9	6.1x4.4	14.0x21.0	136	7,21
1203004	111M-10	10	6.5x5.1	15.7x22.9	144	7,26
1203005	111M-11	11	6.9x5.4	17.2x25.2	153	7,89
1203006	111M-12	12	7.1x5.6	18.4x27.0	160	8,33
1203007	111M-13	13	7.6x5.8	19.7x29.2	169	8,77
1203008	111M-14	14	8.2x6.3	21.7x31.0	177	9,13
1203009	111M-15	15	8.4x6.7	22.7x33.5	185	9,46
1203010	111M-16	16	9.0x7.1	24.0x35.5	195	10,00
1203011	111M-17	17	9.6x7.2	25.6x37.5	200	10,69
1203012	111M-18	18	10.0x7.5	26.8x39.1	208	11,27
1203013	111M-19	19	10.9x7.8	28.3x41.3	218	12,88
1203014	111M-20	20	11.4x7.7	29.8x42.0	240	13,03
1203015	111M-21	21	12.2x7.9	32.9x45.0	250	14,89
1203016	111M-22	22	12.2x7.9	32.9x45.0	250	15,02
1203017	111M-23	23	13.2x8.4	36.1x49.0	280	15,90
1203018	111M-24	24	13.2x8.4	36.1x49.0	270	16,63

Ref.	Código	Entrecaras mm	a1x a2 mm	b1x b2 mm	L mm	€/ u.
1203019	111M-25	25	14.2x8.9	40.0x53.0	290	18,04
1203020	111M-26	26	14.2x8.9	40.0x53.0	290	21,41
1203021	111M-27	27	14.7x8.9	42.0x58.0	310	23,55
1203022	111M-28	28	14.7x8.9	42.0x58.0	310	25,16
1203023	111M-29	29	15.2x9.5	46.1x60.0	330	25,79
1203024	111M-30	30	15.2x9.5	46.1x60.0	330	28,69
1203025	111M-32	32	16.2x9.5	49.2x67.0	350	30,92
1203026	111M-34	34	16.2x9.5	49.2x67.0	350	35,79
1203027	111M-36	36	19.4x13.5	53.0x74.0	410	50,58
1203029	111M-41	41	21.6x16.0	61.0x84.0	460	64,22
1203030	111M-46	46	23.0x17.0	66.0x92.0	500	84,69
1203031	111M-50	50	24.6x18.0	73.0x102	540	95,92
1203032	111M-55	55	21.5x28.0	86.0x118	560	167,26
1203033	111M-60	60	23.5x30.0	94.0x126	600	221,89
1203034	111M-65	65	25.0x32.0	108x148	680	295,49
1203035	111M-70	70	25.0x32.0	108x148	680	351,24
1203036	111M-75	75	25.0x35.0	115x155	730	442,67
1203037	111M-80	80	25.0x35.0	115x155	730	510,69

111Z - Llave combinada, pulgadas



ISO 691 - 7738 -3318 - 1711-1 ·

DIN 3113. Dureza: 44 ÷ 50 HRC.

Recubrimiento cromado.

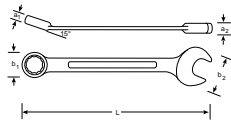

Ref.	Código	Entrecaras "	a1x a2 mm	b1x b2 mm	L mm	€/ u.
1203200	111Z-1/4	1/4	5.0x3.7	10.0x14.3	112	6,07
1203201	111Z-5/16	5/16	5.8x4.2	12.8x19.0	130	6,27
1203202	111Z-3/8	3/8	6.5x5.1	15.7x22.9	144	7,62
1203203	111Z-7/16	7/16	6.9x5.4	17.2x25.2	153	8,30
1203204	111Z-1/2	1/2	7.6x5.8	19.7x29.2	169	9,18
1203205	111Z-9/16	9/16	8.2x6.3	21.7x31.0	177	9,67
1203206	111Z-5/8	5/8	9.0x7.1	24.0x35.5	195	10,49
1203207	111Z-11/16	11/16	9.6x7.2	25.6x37.5	200	11,10
1203208	111Z-3/4	3/4	10.9x7.8	28.3x41.3	218	13,29

Ref.	Código	Entrecaras "	a1x a2 mm	b1x b2 mm	L mm	€/ u.
1203209	111Z-13/16	13/16	12.2x7.9	32.9x45.0	250	15,45
1203210	111Z-7/8	7/8	12.2x7.9	32.9x45.0	250	15,71
1203211	111Z-15/16	15/16	13.2x8.4	36.1x49.0	270	17,50
1203212	111Z-1	1	14.2x8.9	40.0x53.0	290	18,90
1203213	111Z-1.1/16	1.1/16	14.7x8.9	42.0x58.0	310	24,51
1203214	111Z-1.1/8	1.1/8	14.7x8.9	42.0x58.0	310	26,19
1203216	111Z-1.1/4	1.1/4	16.2x9.5	49.2x67.0	350	32,05
1203217	111Z-1.5/16	1.5/16	16.2x9.5	49.2x67.0	350	37,30





TAHIRM - Llave combinada con muelle de seguridad

Llave combinada con muelle de seguridad para trabajos en altura

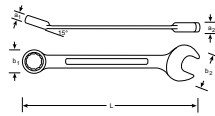

Ref.	Código	Entrecaras mm	L mm	€/ u.	Ref.	Código	Entrecaras mm	L mm	€/ u.
2400154	TAHIRM-10	10	159	30,18	2400162	TAHIRM-18	18	237	39,28
2400155	TAHIRM-11	11	165	31,84	2400163	TAHIRM-19	19	248	41,04
2400156	TAHIRM-12	12	172	32,72	2400164	TAHIRM-21	21	290	50,80
2400157	TAHIRM-13	13	178	31,87	2400165	TAHIRM-22	22	290	49,16
2400158	TAHIRM-14	14	191	36,17	2400166	TAHIRM-24	24	232	53,36
2400159	TAHIRM-15	15	200	37,17	2400167	TAHIRM-27	27	359	80,87
2400160	TAHIRM-16	16	206	38,05	2400168	TAHIRM-30	30	400	95,53
2400161	TAHIRM-17	17	226	38,05					

42INOX Llave combinada, acero inoxidable



• Cabezas compactas • Alta resistencia a la corrosión • Evita la oxidación incorrecta • Características mecánicas sobresalientes • Acero inoxidable AISI 420



Ref.	Código	Entrecaras mm	L mm	A mm	Ø mm	S1 mm	S2 mm	€/ u.
8005039	420306	6x6	95	15,2	10,1	3,4	5,2	16,00
20024864	420307	7x7	105	17,1	11,1	3,6	5,7	17,40
8005040	420308	8x8	116	19,0	12,3	3,9	6,2	18,40
8005041	420310	10x10	137	22,8	15,1	4,5	7,1	20,30
8005042	420311	11x11	148	24,8	16,5	4,8	7,5	22,50
8005043	420312	12x12	158	26,9	18,2	5,1	8,4	23,00
8005044	420313	13x13	169	28,8	19,6	5,4	8,8	24,40
8005045	420314	14x14	180	30,8	21,0	5,7	9,7	26,00
8005046	420315	15x15	190	32,7	22,4	6,0	10,2	27,50
8005047	420316	16x16	201	34,6	23,8	6,3	11,4	28,00
8005048	420317	17x17	212	36,6	25,2	6,7	11,6	29,00
20024866	420318	18x18	222	38,5	26,7	7	11,8	31,50
8005049	420319	19x19	233	40,5	28,0	7,3	12,2	34,00
20024868	420322	22x22	264	46,4	32,2	8,1	12,8	44,50
20024869	420324	24x24	285	50,3	34,9	8,5	13,5	49,00
20024870	420327	27x27	290	53,0	42,0	9,0	12,0	124,00
20024871	420330	30x30	320	59,0	46,0	10,0	13,0	149,50
20024872	420332	32x32	340	63,0	49,0	11,0	14,0	163,50
20024873	420336	36x36	360	70,0	55,0	16,0	21,0	232,50
20024874	420338	38x38	430	85,0	64,0	16,0	21,0	246,00
20024875	420341	41x41	430	85,0	64,0	16,0	21,0	288,00
20024876	420343	46x46	480	90,0	70,0	16,0	22,0	336,00
20024877	420345	50x50	520	98,0	77,0	17,0	23,0	359,00
20024878	420347	55x55	560	108,0	83,0	18,0	23,0	391,00
20024879	420350	60x60	595	115,0	89,0	20,0	25,0	436,00
20024865	420309	9x9	127	20,9	14,1	4,2	6,7	19,00
20024867	420321	21x21	254	44,5	30,7	7,9	12,4	43,50

42INOX-AS Llave combinada acero inoxidable, pulgadas



01

• Cabezas compactas • Alta resistencia a la corrosión • Evita la oxidación incorrecta • Características mecánicas sobresalientes • Acero inoxidable AISI 420

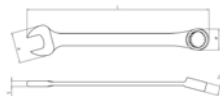

Ref.	Código	Entrecaras "	L mm	A mm	Ø mm	S1 mm	S2 mm	€/ u.
8005050	420356	1/4x1/4	95	15,2	10,1	3,4	5,2	20,40
8005051	420358	5/16x5/16	116	19,0	12,3	3,9	6,2	22,40
8005052	420360	3/8x3/8	137	22,8	15,1	4,5	7,1	26,00
8005053	420361	7/16x7/16	148	24,8	16,5	4,8	7,5	27,50
8005054	420363	1/2x1/2	169	28,8	19,6	5,4	8,4	29,00
8005055	420364	9/16x9/16	180	30,8	21,0	5,7	8,8	31,50
8005056	420366	5/8x5/8	201	34,6	23,8	6,3	9,7	32,00
8005057	420367	11/16x11/16	212	36,6	25,2	6,7	10,2	36,00
8005058	420369	3/4x3/4	233	40,5	28,0	7,3	11,4	40,50
20024880	420371	13/16x13/16	254	44,5	30,7	7,9	12,4	49,00
20024881	420372	7/8x7/8	264	46,4	32,2	8,1	12,8	50,50
20024882	420373	15/16x15/16	285	50,3	34,9	8,5	13,5	58,00

Llave combinada, antichispa



Las herramientas ENDRES son antichispas, antimagnéticas y muy resistentes a la corrosión. Se fabrican con una aleación (aluminio-bronce especial, cobre-berilio), y están homologadas por los pertinentes organismos oficiales de investigación de materiales. Los moldes y los controles de calidad de las herramientas cumplen las normas DIN. Nuestro alto nivel de calidad se consigue y mantiene gracias a dichos programas de control de calidad.



Ref.	Código	Entrecaras mm	L mm	€/ u.	Ref.	Código	Entrecaras mm	L mm	€/ u.
1280500	EN0130006S	6	130	64,89	1280513	EN0130019S	19	230	110,74
1280501	EN0130007S	7	130	64,89	1280514	EN0130020S	20	230	124,66
1280502	EN0130008S	8	135	64,89	1280515	EN0130021S	21	250	124,66
1280503	EN0130009S	9	150	64,89	1280516	EN0130022S	22	250	129,76
1280504	EN0130010S	10	150	64,89	1280517	EN0130023S	23	250	141,31
1280505	EN0130011S	11	150	68,74	1280518	EN0130024S	24	270	141,31
1280506	EN0130012S	12	190	87,79	1280519	EN0130025S	25	270	175,58
1280507	EN0130013S	13	190	87,79	1280520	EN0130026S	26	270	175,58
1280508	EN0130014S	14	190	91,66	1280521	EN0130027S	27	280	175,58
1280509	EN0130015S	15	210	103,16	1280522	EN0130028S	28	280	210,03
1280510	EN0130016S	16	210	103,16	1280523	EN0130029S	29	280	210,03
1280511	EN0130017S	17	210	103,16	1280524	EN0130030S	30	300	210,03
1280512	EN0130018S	18	230	110,74					

111M - Juego de llaves combinadas



Ref.	Código	Composición	Contenido piezas	€/ u.
1203305	111M/S10	8 - 9 - 10 - 11 - 12 - 13 - 14 - 17 - 19 - 22	10	94,61
1203307	111M/SH12	6 - 9 - 10 - 11 - 12 - 13 - 14 - 15 - 16 - 17 - 18-19	12	120,02
1203500	1952M/7T	8 - 10 - 13 - 14 - 17 - 19 - 22	7	109,13
1203501	111M/14T	6 - 8 - 9 - 10 - 13 - 14 - 15 - 17 - 19 - 22 - 24 - 27 - 30 - 32	14	199,01
1203502	111M/17T	8 - 9 - 10 - 11 - 12 - 13 - 14 - 15 - 16 - 18 - 19 - 22 - 24 - 26 - 27 - 30 - 32	17	172,23
1203503	111M/26T	6 - 7 - 8 - 9 - 10 - 11 - 12 - 13 - 14 - 15 - 16 - 17 - 18 - 19 - 20 - 21 - 22 - 23 - 24 - 25 - 26 - 27 - 28 - 29 - 30 - 32	26	380,62
1203601	111Z/8T	3/8 - 7/16 - 1/2 - 9/16 - 5/8 - 11/16 - 3/4 - 7/8	8	95,86
1203602	111Z/11T	3/8 - 7/16 - 1/2 - 9/16 - 5/8 - 11/16 - 3/4 - 13/16 - 7/8 - 15/16 - 1	11	153,78



01

Juego de llaves combinadas de carraca y adaptadores



Aleación de acero de alto rendimiento. Pulido fino. Suministrado en un estuche de plástico compacto. Llaves combinadas con carraca 1RM-10, -13 y -19 con ángulo de acción de 5°, palanca para cambio de sentido y acodadas 15°. Adaptadores para vasos de 1/4", 3/8" y 1/2" con botón de fijación de seguridad. Adaptadores para puntas de 1/4" y 5/16" con anillo de contención. Caja: Polietileno de Alta Densidad (HDPE). ISO 3318 / 1174, DIN 3113 / 3120.

Ref.	Código	Composición	Contenido piezas	Dimensiones	€ / u.
1309607	1RMA/S8	1RMA-10-1/4-SQ - 1RMA-13-3/8-SQ - 1RMA-19-1/2-SQ - 1RMA-10-1/4-BIT - 1RM 10, 13, 19 mm 1RMA-10-1/4-SQ - 1RMA-13-3/8-SQ - 1RMA-19-1/2-SQ - 1RMA-10-1/4-BIT - 1RM 10, 13, 19 mm	8	75x283x160	139,75



Juego de llaves combinadas



Ref.	Código	Composición	Contenido piezas	€ / u.
8005607	M4523008783	10 - 11 - 12 - 13 - 14 - 17 - 19 - 22	8	73,80



42INOX/S11 Juego de 11 llaves combinadas, acero inoxidable



Cabezas compactas • Alta resistencia a la corrosión • Evita la oxidación incorrecta • Características mecánicas sobresalientes • Acero inoxidable AISI 420

Ref.	Código	Composición mm	€ / u.
8005060	420391	6-8-10-11-12-13-14-15-16-17-19	269,00



42INOX/SC9 Juego de 9 llaves combinadas, acero inoxidable, con soporte



Cabezas compactas • Alta resistencia a la corrosión • Evita la oxidación incorrecta • Características mecánicas sobresalientes • Acero inoxidable AISI 420

Ref.	Código	Composición mm	€ / u.
8005059	420387	8-10-11-12-13-14-15-17-19	237,50



42INOX-AS/S9 Juego de 9 llaves combinadas, acero inoxidable, pulgadas



Cabezas compactas • Alta resistencia a la corrosión • Evita la oxidación incorrecta • Características mecánicas sobresalientes • Acero inoxidable AISI 420

Ref.	Código	Composición "	€ / u.
8005061	420396	1/4-5/16-3/8-7/16-1/2-9/16-5/8-11/16-3/4	265,00



Llave combinada con carraca



ISO 1711 · DIN 3113



Ref.	Código	Entrecaras mm	L mm	€/ u.
8004679	4523500083	8	134	42,40
8004680	4523500093	9	158	43,92
8004681	4523500103	10	158	43,92
8004682	4523500113	11	158	45,68
8004683	4523500123	12	167	47,28
8004684	4523500133	13	177	50,56
8004685	4523500143	14	189	53,92

Ref.	Código	Entrecaras mm	L mm	€/ u.
8004686	4523500153	15	198	57,20
8004687	4523500163	16	204	58,56
8004688	4523500173	17	224	62,00
8004689	4523500183	18	245	66,88
8004690	4523500193	19	245	69,20
8004691	4523500223	22	279	100,72
8004692	4523500243	24	309	119,92

IRM - Llave combinada con carraca



ISO 1711 · DIN 3113

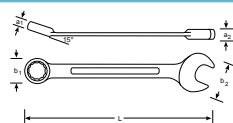

Ref.	Código	Entrecaras mm	a1x a2 mm	b1x b2 mm	L mm	€/ u.
1204100	IRM-6	6	6.3x3.9	14.0x15.0	128	22,55
1204101	IRM-7	7	6.5x4.6	16.6x16.7	140	22,55
1204102	IRM-8	8	6.5x4.6	16.6x16.7	140	23,82
1204103	IRM-9	9	6.9x4.9	18.4x18.8	150	24,12
1204104	IRM-10	10	7.3x5.3	20.0x20.8	159	25,75
1204105	IRM-11	11	7.7x5.6	21.8x23.0	165	27,33
1204106	IRM-12	12	8.2x6.0	22.7x25.0	172	29,35
1204107	IRM-13	13	8.8x6.4	24.7x27.1	178	30,40
1204108	IRM-14	14	9.0x6.8	27.0x29.2	191	31,72
1204109	IRM-15	15	9.4x7.0	28.3x31.3	200	32,61

Ref.	Código	Entrecaras mm	a1x a2 mm	b1x b2 mm	L mm	€/ u.
1204110	IRM-16	16	9.9x7.2	30.0x33.4	208	35,55
1204111	IRM-17	17	10.3x7.7	31.8x35.5	226	35,86
1204112	IRM-18	18	10.7x8.2	32.8x37.6	237	38,80
1204113	IRM-19	19	11.2x8.8	33.8x39.7	248	39,13
1204115	IRM-22	22	13.0x9.0	40.0x46.0	290	42,15
1204116	IRM-24	24	14.5x10.0	46.0x52.0	323	45,54
1204117	IRM-27	27	15.5x10.5	52.5x56.5	359	53,16
1204118	IRM-30	30	17.0x11.4	58.5x62.7	493	64,30
1204119	IRM-32	32	17.5x12.5	62.5x66.4	425	69,96

17 SW - Llave combinada con carraca



Aleación acero. Cromadas.



Ref.	Código	Entrecaras mm	Ancho mm	Alto mm	L mm	€/ u.
20004048	41170808	8	18	10	145	23,55
20004049	41170909	9	20	11	150	24,65
20004050	41171010	10	22	13	155	25,35
20004051	41171111	11	22	13	162	27,25
20004052	41171212	12	23	13	170	28,35
20004053	41171313	13	24	13	180	28,55
20004054	41171414	14	27	15	188	30,50
20004055	41171515	15	29	15	200	32,50

Ref.	Código	Entrecaras mm	Ancho mm	Alto mm	L mm	€/ u.
20004056	41171616	16	29	15	213	34,40
20004057	41171717	17	30	17	227	35,35
20004058	41171818	18	32	18	237	38,70
20004059	41171919	19	34	19	250	40,05
21109000	41172121	21	43	20	280	63,35
21109001	41172222	22	45	21	300	67,50
21109002	41172424	24	50	22	330	72,90

Llave combinada con carraca articulada



Llave combinada con carraca articulada, dimensiones métricas. Según: ISO 3318 y DIN 3113. Material: Aleación de acero de alto rendimiento. Boca abierta con ángulo de 15° con una cabeza más fina para obtener mejor accesibilidad. Carraca articulada 180° con paso fijo cada 15°. Palanca para cambio rápido de sentido [izquierdas/derechas], ángulo de acción de 5°. Perfil Dynamic Drive bihexagonal que prolonga la vida de tuercas y tornillos. Cromado mate que proporciona una gran calidad superficial.

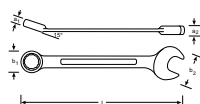

Ref.	Código	Entrecaras mm	a1x a2 mm	b1x b2 mm	L mm	€/ u.
1405308	4IRM-8	8	6.5x4.3	17.0x17.0	127	22,07
1405310	4IRM-10	10	7.3x5.0	20.0x21.0	136	24,04
1405311	4IRM-11	11	7.7x5.4	22.0x23.0	141	25,27
1405312	4IRM-12	12	8.2x5.8	23.0x25.0	148	27,28
1405313	4IRM-13	13	8.6x6.1	25.0x27.0	154	28,07

Ref.	Código	Entrecaras mm	a1x a2 mm	b1x b2 mm	L mm	€/ u.
1405314	4IRM-14	14	9.0x6.4	27.0x29.0	160	29,43
1405317	4IRM-17	17	10.3x7.6	32.0x36.0	190	33,27
1405319	4IRM-19	19	11.2x8.6	34.0x40.0	215	37,59
1405321	4IRM-21	21	13.0x9.0	40.0x46.0	274	39,20



IRZ - Llave combinada con carraca, pulgadas



ISO 1711 · DIN 3113

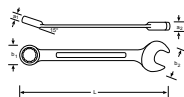

Ref.	Código	Entrecaras "	a1x a2 mm	b1x b2 mm	L mm	€ / u.
1204150	1RZ-1/4	1/4	6.3x3.9	14.0x15.0	128	25,90
1204151	1RZ-5/16	5/16	6.5x4.3	17.0x16.7	140	26,17
1204152	1RZ-3/8	3/8	7.3x5.0	20.2x20.8	158	27,08
1204153	1RZ-7/16	7/16	7.7x5.3	22.0x23.0	165	29,88
1204154	1RZ-1/2	1/2	8.6x6.1	25.5x26.8	178	33,28

Ref.	Código	Entrecaras "	a1x a2 mm	b1x b2 mm	L mm	€ / u.
1204155	1RZ-9/16	9/16	9.0x6.5	26.9x29.0	190	34,58
1204156	1RZ-5/8	5/8	9.9x7.1	29.8x33.0	208	38,27
1204157	1RZ-11/16	11/16	10.3x7.5	31.8x36.5	225	40,71
1204158	1RZ-3/4	3/4	11.2x8.6	34.0x39.4	247	44,22

IR - Juego de llaves combinadas con carraca



IRM

Ref.	Código	Composición	Contenido piezas	€ / u.
1204200	IRM/SH6	8 - 10 - 12 - 13 - 14 - 17	6	183,46
1204202	IRM/SH12	8 - 9 - 10,11 - 12 - 13 - 14 - 15 - 16 - 17 - 18 - 19	12	387,58



IRZ

Ref.	Código	Composición	Contenido piezas	€ / u.
1204250	IRZ/SH8	5/8 - 3/8 - 7/16 - 1/2 - 9/16 - 5/8 - 11/16 - 3/4	8	282,95

Juego llaves combinadas con carraca



Aleación acero. Cromadas.

Ref.	Código	Composición	€ / u.
20006156	96411705	8-10-13-17-19	148,15
20006157	96411712	8-9-10-11-12-13-14-15-16-17-18-19	353,00



Juego de llaves combinadas con carraca, extracortas



Juego de la versión corta de las llaves combinadas con carraca. Embalaje: Expositor de plástico con asa.

Ref.	Código	Composición mm	Contenido piezas	€ / u.
1405357	10RM/SH6	8 - 10 - 13 - 14 - 17 - 19	6	143,69



Juego de llaves de dos bocas fijas ELECTRIC



Ref.	Código	Composición	Contenido piezas	€ / u.
1204190	96400653	4 - 4,5 - 5 - 5,5 - 6 - 7 - 8 - 9 - 10 - 11	12/10	107,50
1204191	96400651	3,2 - 3,5 - 4 - 4,5 - 5 - 5,5 - 6 - 7 - 8 - 9 - 10 - 11 - 12 - 13 - 14	12/15	169,65
1204192	96404654	5/32 - 3/16 - 13/64 - 7/32 - 15/64 - 1/4 - 9/32 - 5/16 - 11/32 - 3/8 - 7/16 - 1/2 - 9/16	12a/13	156,50



26S - Volvedor para llave de tubo



Recubrimiento cromado.

Ref.	Código	Para llave	Longitud mm	€/ u.
1204700	26S-610	6 - 8 - 10	195	11,34
1204701	26S-1216	12 - 14 - 16	390	26,48



27M - Llave de tubo



UNE 16586. Dureza: 42 ÷ 48 HRC. Recubrimiento cromado.

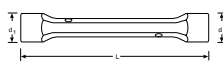

Ref.	Código	Entrecaras mm	D1 mm	D2 mm	L mm	€/ u.
1204600	27M-6-7	6x7	10.0	11.0	103	13,27
1204601	27M-8-9	8x9	12.5	13.5	108	13,41
1204602	27M-10-11	10x11	15.0	16.0	120	14,24
1204603	27M-12-13	12x13	17.0	19.0	138	16,82
1204604	27M-13-17	13x17*	20	24	153	22,41
1204605	27M-14-15	14x15	20.0	21.0	143	18,80
1204606	27M-16-17	16x17*	22	24	153	21,81
1204607	27M-16-18	16x18*	24.0	25.0	158	23,19

Ref.	Código	Entrecaras mm	D1 mm	D2 mm	L mm	€/ u.
1204608	27M-18-19	18x19*	25.0	26.0	163	26,05
1204610	27M-20-22	20x22*	28.0	30.0	173	29,72
1204611	27M-21-23	21x23*	29.0	31.0	183	33,05
1204612	27M-21-24	21x24*	30.0	33.0	183	34,52
1204613	27M-24-26	24x26*	33.0	35.0	193	35,30
1204614	27M-24-27	24x27*	33.0	37.0	193	35,92
1204615	27M-25-28	25x28*	34.0	37.0	203	40,60
1204616	27M-27-29	27x29*	37.0	39.0	592	46,37

28MV - Llave de tubo, aislada

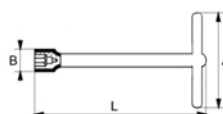

Ref.	Código	Boca bihexagonal	A mm	B mm	L mm	€/ u.
1243800	28MV-8	8	130	16.5	200	36,51
1243801	28MV-9	9	130	18.0	200	36,51
1243802	28MV-10	10	130	19.5	200	36,85
1243803	28MV-11	11	130	20.5	200	37,32
1243804	28MV-12	12	140	22.0	200	37,65
1243805	28MV-13	13	140	23.0	200	37,97
1243806	28MV-14	14	140	24.5	200	42,54
1243807	28MV-15	15	140	25.5	200	43,03

Ref.	Código	Boca bihexagonal	A mm	B mm	L mm	€/ u.
1243808	28MV-16	16	140	27.0	200	44,18
1243809	28MV-17	17	140	28.0	200	44,81
1243810	28MV-18	18	140	29.5	200	46,07
1243811	28MV-19	19	140	30.5	200	46,07
1243812	28MV-20	20	140	32.5	200	45,92
1243813	28MV-21	21	140	33.0	200	46,24
1243814	28MV-22	22	140	34.5	200	48,45

27M - Juego de llaves de tubo



Ref.	Código	Composición	Contenido piezas	€/ u.
1204800	27M/6	6x7 - 8x9 - 10x11 - 12x13 - 14x15 - 16x17	6	98,35
1204801	27M/8	6x7 - 8x9 - 10x11 - 12x13 - 14x15 - 16x17 - 18x19 - 20x22	8	154,09
1204802	27M/10	6x7 - 8x9 - 10x11 - 12x13 - 14x15 - 16x17 - 18x19 - 20x22 - 21x23 - 24x26	10	222,42
1204803	27M/12	6x7 - 8x9 - 10x11 - 12x13 - 14x15 - 16x17 - 18x19 - 20x22 - 21x23 - 24x26 - 25x28 - 30x32	12	315,00
1204900	27M/8T	6x7 - 8x9 - 10x11 - 12x13 - 14x15 - 16x17 - 18x19 - 20x22	8	158,28
1204901	27M/12T	6x7 - 8x9 - 10x11 - 12x13 - 14x15 - 16x17 - 18x19 - 20x22 - 21x23 - 24x26 - 25x28 - 30x32	12	321,27



1204803



1204900

4040M - Llave de vaso articulada de dos bocas



Recubrimiento cromado.

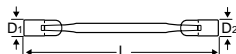

Ref.	Código	Entrecaras mm	D1 mm	D2 mm	L mm	€/ u.
1205000	4040M-6-7	6x7	9.1	10.3	192	38,95
1205001	4040M-8-9	8x9	11.6	12.8	194	39,89
1205002	4040M-10-11	10x11	14.1	15.3	199	40,76
1205003	4040M-10-13	10x13	14.1	17.8	221	45,27
1205004	4040M-12-13	12x13	16.6	17.8	224	42,45
1205005	4040M-14-15	14x15	19.1	20.3	249	44,50

Ref.	Código	Entrecaras mm	D1 mm	D2 mm	L mm	€/ u.
1205006	4040M-16-17	16x17	21.6	22.8	253	48,56
1205008	4040M-18-19	18x19	24.2	25.3	303	55,34
1205009	4040M-20-22	20x22	26.6	29.1	305	65,74
1205010	4040M-21-23	21x23	27.8	30.5	306	68,49

4040M - Juego de llaves de vaso articuladas



Ref.	Código	Composición	Contenido piezas	€/ u.
1205050	4040M/6T	8x9 - 10x11 - 12x13 - 14x15 - 16x17 - 18x19	6	267,07
1205055	4040M/S6	8x9 - 10x11 - 12x13 - 14x15 - 16x17 - 18x19	6	283,48



1205050



1205055

28M - Llave de pipa abierta de 12x6



ISO 2236. Recubrimiento cromado.

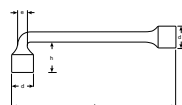

Ref.	Código	Entrecaras mm	d mm	e Ø mm	h mm_1	L mm	€/ u.
1205100	28M-6	6	10.0	5	17	95	14,75
1205101	28M-7	7	11.0	5	19	100	15,36
1205102	28M-8	8	12.0	7	24	110	12,64
1205103	28M-9	9	13.0	7	25	115	12,52
1205104	28M-10	10	14.5	7	27	125	13,21
1205105	28M-11	11	16.5	8	29	130	13,80
1205106	28M-12	12	17.5	9	31	145	14,63
1205107	28M-13	13	19.0	9	34	160	15,71
1205108	28M-14	14	20.5	10	36	175	18,00
1205109	28M-15	15	21.5	10	38	180	19,07
1205110	28M-16	16	23.0	13	43	190	20,11
1205111	28M-17	17	24.5	13	44	195	20,93
1205112	28M-18	18	25.5	14	45	200	25,25

Ref.	Código	Entrecaras mm	d mm	e Ø mm	h mm_1	L mm	€/ u.
1205113	28M-19	19	27.0	14	48	210	26,65
1205114	28M-20	20	28	15	50	220	28,56
1205115	28M-21	21	29.5	15	51	225	31,05
1205117	28M-23	23	32.5	16	58	245	37,55
1205118	28M-24	24	33.5	18	60	255	39,80
1205119	28M-25	25	35	18	58	260	45,42
1205120	28M-26	26	36.5	20	58	265	49,33
1205121	28M-27	27	37.0	20	63	275	53,87
1205122	28M-28	28	39	22	63	285	62,03
1205123	28M-29	29	40	22	63	295	70,73
1205124	28M-30	30	41.0	24	75	305	80,27
1205125	28M-32	32	44.0	24	75	330	95,67

28M - Juego de llaves de pipa abiertas de 12x6



Ref.	Código	Composición	Contenido piezas	€/ u.
1205201	28M/8	8 - 10 - 11 - 13 - 16 - 17 - 18 - 19	8	145,69
1205203	28M/11	8 - 9 - 10 - 11 - 12 - 13 - 14 - 15 - 17 - 19 - 22	11	200,05
1205204	28M/12	8 - 9 - 10 - 11 - 12 - 13 - 14 - 15 - 16 - 17 - 18 - 19	12	209,34
1205205	28M/15	8 - 9 - 10 - 11 - 12 - 13 - 14 - 15 - 16 - 17 - 18 - 19 - 21 - 22 - 24	15	316,26



29M - Llave de pipa abierta de 6x6



ISO 2236. Acero cromo vanadio tratado. Cromadas. Permite el paso del espárrago. Bocas hexagonales.

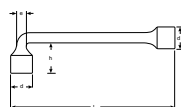

Ref.	Código	Entrecaras mm	d mm	e Ø mm	h mm_1	L mm	€/ u.
1205400	29M-6	6	10	6	17	97	14,75
1205401	29M-7	7	11	7	19	105	15,36
1205402	29M-8	8	12	8	21	115	13,22
1205403	29M-9	9	13	9	22	126	13,13
1205404	29M-10	10	15	10	25	136	13,21
1205405	29M-11	11	16.5	11	28	145	13,71
1205406	29M-12	12	17.5	12	29	157	14,85
1205407	29M-13	13	19	13	31	168	15,40
1205408	29M-14	14	20.5	14	33	178	18,00
1205409	29M-15	15	21.5	15	36	187	19,07
1205410	29M-16	16	23	16	38	200	20,11
1205411	29M-17	17	24.5	17	40	208	20,29
1205412	29M-18	18	25.5	18	42	220	25,25

Ref.	Código	Entrecaras mm	d mm	e Ø mm	h mm_1	L mm	€/ u.
1205413	29M-19	19	27	19	43	232	26,65
1205414	29M-20	20	28	20	46	243	28,56
1205415	29M-21	21	29.5	21	48	252	31,05
1205416	29M-22	22	31	22	50	266	36,06
1205417	29M-23	23	32.5	23	52	278	37,55
1205418	29M-24	24	33.5	24	55	288	39,80
1205419	29M-25	25	35	25	58	299	45,42
1205420	29M-26	26	36.5	26	60	312	49,33
1205421	29M-27	27	37	27	61	323	53,87
1205422	29M-28	28	39	28	64	334	62,03
1205423	29M-29	29	40	29	66	345	70,73
1205424	29M-30	30	41	30	68	357	80,27
1205425	29M-32	32	44	32	72	381	95,67

29M - Juego de llaves de pipa abiertas de 6x6



Ref.	Código	Composición	Contenido piezas	€/ u.
1205502	29M/8	8 - 10 - 12 - 13 - 14 - 17 - 19 - 22	8	158,79
1205504	29M/10	8 - 10 - 11 - 12 - 13 - 14 - 16 - 17 18 - 19	10	178,12
1205505	29M/14	8 - 9 - 10 - 11 - 12 - 13 - 14 - 16 17 - 19 - 21 - 22 - 23 - 24	14	309,50



Llave fija de golpe



DIN 133



Ref.	Código	Entrecaras mm	L mm	€/ u.
8004693	0006702407	24	180	44,24
8004694	0006702707	27	180	44,24
8004695	0006703007	30	190	49,60
8004696	0006703207	32	190	69,12
8004697	0006703407	34	200	83,92
8004698	0006703607	36	215	83,92
8004699	0006703807	38	225	83,92
8004700	0006704107	41	235	88,80
8004701	0006704607	46	255	153,44
8004702	0006705007	50	275	162,48

Ref.	Código	Entrecaras mm	L mm	€/ u.
8004703	0006705507	55	300	212,32
8004704	0006706007	60	320	244,96
8004705	0006706507	65	340	283,28
8004706	0006707007	70	375	345,60
8004707	0006707507	75	375	428,32
8004708	0006708007	80	408	583,44
8004709	0006708507	85	408	605,04
8004710	0006709007	90	445	713,20
8004711	0006709507	95	445	734,72

133SGM - Llave fija de golpe



DIN 133.

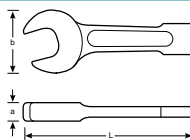

Ref.	Código	Entrecaras mm	A mm	B mm	L mm	€/ u.
1205800	133SGM-30	30	17.0	62	190	33,95
1205801	133SGM-32	32	17.0	62	190	36,01
1205802	133SGM-36	36	17.5	76	215	46,40
1205803	133SGM-41	41	18.5	86	235	56,88
1205804	133SGM-46	46	20.0	98	255	76,60
1205805	133SGM-50	50	21.0	105	275	87,27
1205806	133SGM-55	55	23.0	116	300	101,79
1205807	133SGM-60	60	24.5	128	320	113,12
1205808	133SGM-65	65	27.0	138	342	141,75
1205809	133SGM-70	70	30.0	154	375	182,61

Ref.	Código	Entrecaras mm	A mm	B mm	L mm	€/ u.
1205810	133SGM-75	75	30.0	154	375	195,53
1205811	133SGM-80	80	34.0	174	408	255,35
1205812	133SGM-85	85	34.0	174	408	268,27
1205813	133SGM-90	90	38.0	194	445	342,57
1205814	133SGM-95	95	38.0	194	445	360,37
1205815	133SGM-100	100	44.0	215	485	552,66
1205816	133SGM-105	105	44.0	215	485	617,31
1205817	133SGM-110	110	47.0	235	510	673,88
1205818	133SGM-115	115	47.0	235	510	788,62
1205819	133SGM-120	120	50.0	255	545	801,55

Llave fija de golpe, antichispa



Ref.	Código	Entrecaras mm	L mm	€/ u.
1201100	AJ0027A	27	180	120,85
1201101	AJ0028A	28	180	117,33
1201102	AJ0029A	29	180	120,85
1201103	AJ0030A	30	190	147,93
1201104	AJ0032A	32	190	147,93
1201105	AJ0033A	33	190	143,62
1201106	AJ0034A	34	190	147,93
1201107	AJ0035A	35	215	177,73
1201108	AJ0036A	36	215	183,06
1201109	AJ0037A	37	215	177,73
1201110	AJ0038A	38	215	183,06
1201111	AJ0041A	41	235	218,70
1201112	AJ0042A	42	235	212,33
1201113	AJ0046A	46	255	268,14
1201114	AJ0047A	47	255	260,33
1201115	AJ0050A	50	275	310,14
1201116	AJ0052A	52	275	301,11
1201117	AJ0054A	54	300	301,11
1201118	AJ0055A	55	300	353,87

Ref.	Código	Entrecaras mm	L mm	€/ u.
1201119	AJ0056A	56	300	343,56
1201120	AJ0058A	58	320	343,56
1201121	AJ0060A	60	320	454,54
1201122	AJ0063A	63	320	500,72
1201123	AJ0065A	65	340	515,74
1201124	AJ0067A	67	340	500,72
1201125	AJ0070A	70	375	683,17
1201126	AJ0075A	75	375	663,27
1201127	AJ0080A	80	410	922,37
1201128	AJ0085A	85	410	895,50
1201129	AJ0090A	90	445	1.164,80
1201130	AJ0095A	95	445	1.164,80
1201131	AJ0100A	100	485	1.528,24
1201132	AJ0105A	105	485	1.794,44
1201133	AJ0110A	110	510	1.794,44
1201134	AJ0115A	115	510	1.794,44
1201135	AJ0120A	120	545	2.229,22
1201136	AJ0125A	125	545	2.296,10

Llave fija de golpe, antichispa, pulgadas



Ref.	Código	Entrecaras "	L mm	€/ u.
1201140	BJ0027A	1 1/16	180	129,26
1201141	BJ0029A	1 1/8	180	129,26
1201142	BJ0030A	1 3/16	190	157,97
1201143	BJ0032A	1 1/4	190	157,97
1201144	BJ0033A	1 5/16	190	157,97
1201145	BJ0035A	1 3/8	215	195,52
1201146	BJ0037A	1 7/16	215	195,52
1201147	BJ0038A	1 1/2	215	195,52
1201148	BJ0039A	1 9/16	235	233,55
1201149	BJ0041A	1 5/8	235	233,55
1201150	BJ0043A	1 11/16	235	233,55
1201151	BJ0044A	1 3/4	255	233,55
1201152	BJ0046A	1 13/16	255	286,26
1201153	BJ0048A	1 7/8	255	286,26
1201154	BJ0051A	2	275	331,30
1201155	BJ0052A	2 1/16	275	331,30
1201156	BJ0054A	2 1/8	300	331,30
1201157	BJ0056A	2 3/16	300	378,15
1201158	BJ0057A	2 1/4	300	378,15

Ref.	Código	Entrecaras "	L mm	€/ u.
1201159	BJ0059A	2 5/16	320	378,15
1201160	BJ0060A	2 3/8	320	485,54
1201161	BJ0062A	2 7/16	32	485,54
1201162	BJ0064A	2 1/2	340	485,54
1201163	BJ0065A	2 9/16	340	550,82
1201164	BJ0067A	2 5/8	340	550,82
1201165	BJ0070A	2 3/4	375	729,70
1201166	BJ0071A	2 13/16	375	729,70
1201167	BJ0075A	2 15/16	375	729,70
1201168	BJ0076A	3	375	729,70
1201169	BJ0079A	3 1/8	410	984,94
1201170	BJ0083A	3 1/4	410	984,94
1201171	BJ0086A	3 3/8	410	984,94
1201172	BJ0089A	3 1/2	445	1.281,16
1201173	BJ0092A	3 5/8	445	1.281,16
1201174	BJ0095A	3 3/4	445	1.281,16
1201175	BJ0098A	3 7/8	485	1.681,02
1201176	BJ0102A	4	545	1.974,13

Llave de estrella de golpe



DIN 7444



Ref.	Código	Entrecaras mm	L mm	€/ u.
8004713	0002702404	24	165	24,05
8004715	0002702704	27	190	26,50
8004716	0002703004	30	190	24,05
8004717	0002703204	32	190	26,20
8004718	0002703404	34	195	36,10
8004719	0002703604	36	205	47,85
8004720	0002703804	38	215	49,30
8004721	0002704104	41	230	61,10
8004722	0002704604	46	240	62,50
8004723	0002705004	50	255	73,70

Ref.	Código	Entrecaras mm	L mm	€/ u.
8004724	0002705504	55	270	83,35
8004725	0002706004	60	280	96,40
8004726	0002706504	65	300	129,30
8004727	0002707004	70	330	131,20
8004728	0002707504	75	330	154,30
8004729	0002708004	80	360	204,35
8004730	0002708504	85	360	278,80
8004731	0002709004	90	390	340,85
8004732	0002709504	95	390	378,15

7444 SG-M - Llave de estrella de golpe



DIN 7444. Recubrimiento cromado.

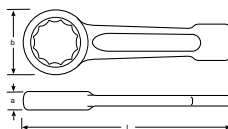

Ref.	Código	Entrecaras mm	A mm	B mm	L mm	€ / u.	Ref.	Código	Entrecaras mm	A mm	B mm	L mm	€ / u.
1205901	7444SG-M-27	27	16	46	180	39,46	1205919	7444SG-M-95	95	40	142	390	421,68
1205902	7444SG-M-30	30	17	52	190	40,66	1205920	7444SG-M-100	100	45	155	420	474,87
1205903	7444SG-M-32	32	17	52	190	40,66	1205940	7444SG-M-105	105	45	155	420	535,71
1205904	7444SG-M-34	34	18	57	205	59,56	1205922	7444SG-M-110	110	48	170	450	590,67
1205906	7444SG-M-36	36	18	58	205	51,91	1205941	7444SG-M-115	115	48	170	450	679,84
1205907	7444SG-M-38	38	18	58	205	61,09	1205942	7444SG-M-120	120	54	182	480	989,69
1205908	7444SG-M-41	41	20	66	230	66,28	1205943	7444SG-M-125	125	54	182	480	1.280,31
1205909	7444SG-M-46	46	22	74	240	72,64	1205944	7444SG-M-130	130	58	202	520	1.392,43
1205910	7444SG-M-50	50	24	80	255	81,67	1205945	7444SG-M-135	135	58	202	520	1.436,30
1205911	7444SG-M-55	55	25	86	270	93,40	1205946	7444SG-M-140	140	58	202	520	1.628,91
1205912	7444SG-M-60	60	26	93	280	98,45	1205947	7444SG-M-145	145	64	228	580	2.261,60
1205913	7444SG-M-65	65	30	102	300	131,94	1205948	7444SG-M-150	150	64	228	580	2.380,87
1205914	7444SG-M-70	70	33	110	330	152,58	1205949	7444SG-M-155	155	64	228	580	2.585,00
1205915	7444SG-M-75	75	33	110	330	163,84	1205950	7444SG-M-160	160	64	228	580	2.739,29
1205916	7444SG-M-80	80	36	126	360	217,98	1205951	7444SG-M-165	165	70	565	650	2.909,95
1205917	7444SG-M-85	85	36	126	360	291,91	1205952	7444SG-M-170	170	70	565	650	3.198,45
1205918	7444SG-M-90	90	40	142	390	381,65	1205953	7444SG-M-175	175	70	565	650	3.431,08

7444 SG-Z - Llave de estrella de golpe, pulgadas



DIN 7444. Recubrimiento cromado.

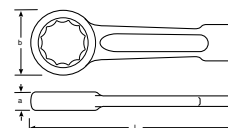

Ref.	Código	Entrecaras **	A mm	B mm	L mm	€ / u.	Ref.	Código	Entrecaras **	A mm	B mm	L mm	€ / u.
1206011	7444SG-Z-1.1/8	1.1/8	16	46	180	44,73	1206022	7444SG-Z-2.3/16	2.3/16	25	86	270	108,32
1206012	7444SG-Z-1.3/16	1.3/16	17	52	190	44,73	1206008	7444SG-Z-2.1/4	2.1/4	25	86	270	108,32
1206013	7444SG-Z-1.1/4	1.1/4	17	52	190	44,73	1206023	7444SG-Z-2.3/8	2.3/8	26	93	280	133,79
1206014	7444SG-Z-1.5/16	1.5/16	17	52	190	65,54	1206024	7444SG-Z-2.9/16	2.9/16	30	102	300	167,85
1206015	7444SG-Z-1.3/8	1.3/8	18	58	205	65,54	1206025	7444SG-Z-2.5/8	2.5/8	30	102	300	167,85
1206003	7444SG-Z-1.7/16	1.7/16	18	58	205	65,54	1206026	7444SG-Z-2.3/4	2.3/4	33	110	330	167,85
1206004	7444SG-Z-1.1/2	1.1/2	18	58	205	67,19	1206027	7444SG-Z-3	3	33	110	330	180,23
1206005	7444SG-Z-1.5/8	1.5/8	20	66	230	72,90	1206028	7444SG-Z-3.1/8	3.1/8	36	126	360	285,36
1206016	7444SG-Z-1.11/16	1.11/16	20	66	230	72,90	1206029	7444SG-Z-3.3/8	3.3/8	36	126	360	321,10
1206017	7444SG-Z-1.3/4	1.3/4	22	74	240	79,91	1270500	7444SG-Z-3.1/2	3.1/2	40	142	390	419,82
1206018	7444SG-Z-1.13/16	1.13/16	22	74	240	79,91	1270501	7444SG-Z-3.3/4	3.3/4	40	142	390	463,86
1206019	7444SG-Z-1.7/8	1.7/8	22	74	240	89,83	1270502	7444SG-Z-3.7/8	3.7/8	45	155	420	522,38
1206007	7444SG-Z-2	2	24	80	255	89,83	1270503	7444SG-Z-4	4	45	155	420	589,27
1206020	7444SG-Z-2.1/16	2.1/16	24	80	255	102,75	1270504	7444SG-Z-4.1/8	4.1/8	45	155	420	589,27
1206021	7444SG-Z-2.1/8	2.1/8	25	86	270	108,32	1270505	7444SG-Z-4.1/2	4.1/2	48	170	450	747,83

NS-104 -Llave estrella de golpe, antichispa



Aluminio bronce

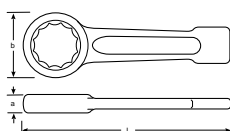

Ref.	Código	Entrecaras mm	L mm	€/ u.
2400169	NS104-25	25	165	99,67
2400170	NS104-26	26	175	99,72
2400171	NS104-27	27	175	99,72
2400172	NS104-28	28	175	104,62
2400173	NS104-29	29	185	106,95
2400174	NS104-30	30	185	111,10
2400175	NS104-31	31	185	114,64
2400176	NS104-32	32	185	116,54
2400177	NS104-33	33	200	127,87
2400178	NS104-34	34	200	135,22
2400179	NS104-35	35	205	138,75
2400180	NS104-36	36	205	136,00
2400181	NS104-37	37	215	136,63
2400182	NS104-38	38	215	142,40
2400183	NS104-39	39	215	172,15
2400184	NS104-40	40	225	175,39
2400185	NS104-41	41	225	178,31
2400186	NS104-42	42	225	193,92
2400187	NS104-43	43	225	198,98
2400188	NS104-44	44	235	193,92
2400189	NS104-45	45	235	197,30
2400190	NS104-46	46	235	202,36
2400191	NS104-47	47	235	219,07
2400192	NS104-48	48	250	222,88
2400193	NS104-49	49	250	226,70

Ref.	Código	Entrecaras mm	L mm	€/ u.
2400194	NS104-50	50	250	230,50
2400195	NS104-51	51	250	236,24
2400196	NS104-52	52	265	242,04
2400197	NS104-53	53	265	243,97
2400198	NS104-54	54	265	245,91
2400199	NS104-55	55	265	262,69
2400200	NS104-56	56	265	269,82
2400201	NS104-57	57	265	274,33
2400202	NS104-58	58	274	278,82
2400203	NS104-59	59	274	283,32
2400204	NS104-60	60	274	308,67
2400205	NS104-61	61	274	319,64
2400206	NS104-62	62	274	326,08
2400207	NS104-63	63	398	336,30
2400208	NS104-64	64	298	346,47
2400209	NS104-65	65	298	337,02
2400210	NS104-66	66	298	327,91
2400211	NS104-67	67	320	333,17
2400212	NS104-68	68	320	402,24
2400213	NS104-69	69	320	402,24
2400214	NS104-70	70	320	380,90
2400215	NS104-71	71	320	405,11
2400216	NS104-72	72	320	407,99
2400217	NS104-73	73	326	410,85
2400218	NS104-74	74	326	413,73

Ref.	Código	Entrecaras mm	L mm	€/ u.
2400219	NS104-75	75	326	459,72
2400220	NS104-76	76	326	478,15
2400221	NS104-77	77	326	484,12
2400222	NS104-78	78	350	498,24
2400223	NS104-79	79	350	512,39
2400224	NS104-80	80	350	526,53
2400225	NS104-81	81	345	555,99
2400226	NS104-82	82	355	562,55
2400227	NS104-83	83	355	569,12
2400228	NS104-84	84	355	575,68
2400229	NS104-85	85	350	582,25
2400230	NS104-86	86	355	644,98
2400231	NS104-87	87	355	659,19
2400232	NS104-88	88	380	673,39
2400233	NS104-89	89	380	687,61
2400234	NS104-90	90	380	647,85
2400235	NS104-92	92	380	738,05
2400236	NS104-94	94	390	747,26
2400237	NS104-95	95	390	669,92
2400238	NS104-98	98	410	794,85
2400239	NS104-100	100	410	788,11
2400240	NS104-105	105	420	853,79
2400241	NS104-110	110	445	1.011,42
2400242	NS104-115	115	450	1.011,42
2400243	NS104-120	120	480	1.313,51

Llave de estrella de golpe, antichispa

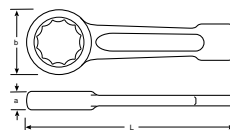

Ref.	Código	Entrecaras mm	L mm	€/ u.
2400244	NSB104-25	25	165	129,61
2400245	NSB104-26	26	175	129,62
2400246	NSB104-27	27	175	137,91
2400247	NSB104-28	28	175	136,00
2400248	NSB104-29	29	185	139,03
2400249	NSB104-30	30	185	144,50
2400250	NSB104-31	31	185	149,04
2400251	NSB104-32	32	185	157,62
2400252	NSB104-33	33	200	149,04
2400253	NSB104-34	34	200	149,04
2400254	NSB104-35	35	205	149,04
2400255	NSB104-36	36	205	183,89
2400256	NSB104-37	37	215	200,60
2400257	NSB104-38	38	215	217,80
2400258	NSB104-39	39	215	254,56
2400259	NSB104-40	40	225	268,23
2400260	NSB104-41	41	225	288,97
2400261	NSB104-42	42	225	296,60
2400262	NSB104-43	43	225	304,34
2400263	NSB104-44	44	235	296,60
2400264	NSB104-45	45	235	301,77
2400265	NSB104-46	46	235	309,51
2400266	NSB104-47	47	235	335,06
2400267	NSB104-48	48	250	340,88
2400268	NSB104-49	49	250	346,72

Ref.	Código	Entrecaras mm	L mm	€/ u.
2400269	NSB104-50	50	250	361,22
2400270	NSB104-51	51	250	361,22
2400271	NSB104-52	52	250	380,90
2400272	NSB104-53	53	265	373,11
2400273	NSB104-54	54	265	376,08
2400274	NSB104-55	55	265	400,63
2400275	NSB104-56	56	265	412,67
2400276	NSB104-57	57	265	419,56
2400277	NSB104-58	58	274	426,43
2400278	NSB104-59	59	274	433,30
2400279	NSB104-60	60	274	440,19
2400280	NSB104-61	61	274	456,65
2400281	NSB104-62	62	274	465,84
2400282	NSB104-63	63	298	480,43
2400283	NSB104-64	64	298	494,96
2400284	NSB104-65	65	298	481,46
2400285	NSB104-66	66	298	501,51
2400286	NSB104-67	67	320	509,53
2400287	NSB104-68	68	320	615,18
2400288	NSB104-69	69	320	615,18
2400289	NSB104-70	70	320	615,21
2400290	NSB104-71	71	320	619,57
2400291	NSB104-72	72	320	623,97
2400292	NSB104-73	73	326	628,36
2400293	NSB104-74	74	326	632,77

Ref.	Código	Entrecaras mm	L mm	€/ u.
2400294	NSB104-75	75	326	637,16
2400295	NSB104-76	76	326	668,36
2400296	NSB104-77	77	326	676,70
2400297	NSB104-78	78	350	696,44
2400298	NSB104-79	79	350	716,25
2400299	NSB104-80	80	350	736,02
2400300	NSB104-81	81	350	777,18
2400301	NSB104-82	82	350	786,35
2400302	NSB104-83	83	355	795,52
2400303	NSB104-84	84	355	804,69
2400304	NSB104-85	85	355	813,88
2400305	NSB104-86	86	355	901,59
2400306	NSB104-87	87	355	921,44
2400307	NSB104-88	88	380	941,29
2400308	NSB104-89	89	380	961,17
2400309	NSB104-90	90	380	905,58
2400310	NSB104-92	92	380	1.031,65
2400311	NSB104-94	94	390	1.044,56
2400312	NSB104-95	95	390	1.057,48
2400313	NSB104-100	100	410	1.239,35
2400314	NSB104-105	105	420	1.315,39
2400315	NSB104-110	110	445	1.539,87
2400316	NSB104-115	115	450	2.310,95
2400317	NSB104-120	120	480	1.975,17

Llave de estrella de golpe, antichispa



Ref.	Código	Entrecaras mm	Longitud mm	€/ u.
1200905	AH0017A	17	145	105,90
1200906	AH0019A	19	170	105,90
1200907	AH0022A	22	170	105,90
1200908	AH0024A	24	170	105,90
1200909	AH0025A	25	180	105,90
1200910	AH0026A	26	180	105,90
1200911	AH0027A	27	190	105,90
1200912	AH0028A	28	190	105,90
1200913	AH0029A	29	190	105,90
1200914	AH0030A	30	205	124,89
1200915	AH0032A	32	205	124,89
1200916	AH0033A	33	205	121,30
1200917	AH0034A	34	230	124,94
1200918	AH0035A	35	230	130,24
1200919	AH0036A	36	230	134,15
1200920	AH0037A	37	242	130,24
1200921	AH0038A	38	242	134,15
1200922	AH0041A	41	242	176,68
1200923	AH0042A	42	254	176,68
1200924	AH0046A	46	254	200,72
1200925	AH0047A	47	268	194,87
1200926	AH0050A	50	268	234,52
1200927	AH0052A	52	268	227,67
1200928	AH0054A	54	283	227,67
1200929	AH0055A	55	283	265,26
1200930	AH0056A	56	283	257,53
1200931	AH0058A	58	283	257,53

Ref.	Código	Entrecaras mm	Longitud mm	€/ u.
1200932	AH0060A	60	300	307,62
1200933	AH0063A	63	300	298,66
1200934	AH0065A	65	325	364,13
1200935	AH0067A	67	325	353,52
1200936	AH0070A	70	325	560,10
1200937	AH0071A	71	325	543,79
1200938	AH0075A	75	358	560,10
1200939	AH0077A	77	358	543,79
1200940	AH0080A	80	358	628,49
1200941	AH0082A	82	388	620,50
1200942	AH0085A	85	388	620,50
1200943	AH0088A	88	388	620,50
1200944	AH0090A	90	415	739,47
1200945	AH0094A	94	415	739,47
1200946	AH0095A	95	415	739,47
1200947	AH0100A	100	450	964,53
1200948	AH0105A	105	450	964,53
1200949	AH0110A	110	475	1.229,90
1200950	AH0115A	115	475	1.229,90
1200951	AH0120A	120	505	1.816,47
1200952	AH0125A	125	505	1.816,47
1200953	AH0130A	130	575	2.426,36
1200954	AH0135A	135	575	2.426,36
1200955	AH0140A	145	575	3.105,79
1200956	AH0145A	150	575	3.105,79
1200957	AH0155A	155	575	3.105,79

Llave de estrella de golpe, antichispa, pulgadas



Ref.	Código	Entrecaras "	Longitud mm	€/ u.
1200958	BH0019A	3/4	145	113,27
1200959	BH0022A	7/8	170	113,27
1200960	BH0024A	15/16	170	113,27
1200961	BH0026A	1	170	113,27
1200962	BH0027A	1 1/16	180	113,27
1200963	BH0029A	1 1/8	180	113,27
1200964	BH0030A	1 3/16	190	133,49
1200965	BH0032A	1 1/4	190	137,51
1200966	BH0033A	1 5/16	190	133,50
1200967	BH0035A	1 3/8	205	143,30
1200968	BH0037A	1 7/16	205	143,30
1200969	BH0038A	1 1/2	205	143,30
1200970	BH0039A	1 9/16	230	188,50
1200971	BH0041A	1 5/8	230	188,50
1200972	BH0043A	1 11/16	230	188,50
1200973	BH0044A	1 3/4	242	188,50
1200974	BH0046A	1 13/16	242	213,97
1200975	BH0048A	1 7/8	242	213,97
1200976	BH0051A	2	254	250,34
1200977	BH0052A	2 1/16	254	250,34
1200978	BH0054A	2 1/8	268	250,34
1200979	BH0056A	2 3/16	268	283,65
1200980	BH0057A	2 1/4	268	283,65
1200981	BH0059A	2 5/16	283	283,65
1200982	BH0060A	2 3/8	283	328,70

Ref.	Código	Entrecaras "	Longitud mm	€/ u.
1200983	BH0062A	2 7/16	283	328,70
1200984	BH0064A	2 1/2	283	328,70
1200985	BH0065A	2 9/16	300	389,07
1200986	BH0067A	2 5/8	300	389,07
1200987	BH0070A	2 3/4	325	599,46
1200988	BH0071A	2 13/16	325	599,46
1200989	BH0075A	2 15/16	325	599,46
1200990	BH0076A	3	325	599,46
1200991	BH0079A	3 1/8	358	682,67
1200992	BH0083A	3 1/4	358	682,67
1200993	BH0086A	3 3/8	358	682,67
1200994	BH0089A	3 1/2	388	814,71
1200995	BH0092A	3 5/8	388	814,71
1200996	BH0095A	3 3/4	388	814,71
1200997	BH0098A	3 7/8	415	974,33
1200998	BH0102A	4	415	974,33
1200999	BH0105A	4 1/8	415	1.082,53
1201000	BH0110A	4 5/16	450	1.353,13
1201001	BH0116A	4 9/16	450	1.353,13
1201002	BH0119A	4 11/16	475	1.998,27
1201003	BH0125A	4 15/16	475	1.998,27
1201004	BH0130A	5 1/8	505	2.669,05
1201005	BH0137A	5 3/8	505	2.669,05
1201006	BH0145A	5 11/16	575	3.416,38
1201007	BH0152A	6	575	3.416,38

310M - Llave de estrella de tracción

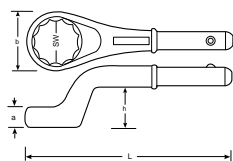

Ref.	Código	Entrecaras mm	A mm	B mm	h mm_1	L mm	€ / u.
1206100	310M-24	24	17.0	38	29.5	180	56,13
1206101	310M-27	27	17.0	41	31.5	190	56,13
1206102	310M-30	30	18.0	48	33.5	200	56,13
1206103	310M-32	32	18.0	49	34.0	235	59,59
1206104	310M-36	36	20.0	54	35.5	245	68,16
1206105	310M-38	38	21.0	56	37.5	250	82,01
1206106	310M-41	41	22.0	62	39.5	265	83,76
1206107	310M-46	46	23.0	69	40.0	280	93,39
1206108	310M-50	50	25.5	76	42.5	290	112,45

Ref.	Código	Entrecaras mm	A mm	B mm	h mm_1	L mm	€ / u.
1206109	310M-55	55	28.0	81	45.5	300	125,86
1206110	310M-60	60	30.5	90	49.0	345	154,83
1206111	310M-65	65	33.0	98	53.0	355	175,07
1206112	310M-70	70	35.5	106	55.0	365	190,84
1206113	310M-75	75	38.0	110	57.5	375	208,17
1206114	310M-80	80	40.5	125	59.0	385	228,69
1206115	310M-85	85	40.5	125	59.0	385	246,05
1206116	310M-90	90	45.0	140	63.0	410	488,93
1206117	310M-95	95	45.0	140	63.0	410	529,93

R310 - Maneral para llave estrella de tracción



Ref.	Código	Entrecaras mm	L mm	Ø mm	€ / u.
1206200	R310-0	24-30	460	19	42,83
1206201	R310-1	32-41	610	22	48,30
1206202	R310-2	46-55	760	25	71,58
1206203	R310-3	60-95	860	30	91,48



186 8-32 Llave de autoapriete para hexágonos de 8 a 32 mm



• Ideal para tornillos con cabeza de perfil: hexagonal, Spline, cuadrado, Torx®; incluso en tornillos dañados • Rápida y versátil • Para realizar alineaciones de la varilla de dirección

Ref.	Código	L mm	€ / u.
8005128	1860008	260	56,00



100 Llave articulada para agujeros frontales



Ref.	Código	Ø mm	L mm	Ø min-max mm	€ / u.
8005124	1000001	4,9-5,9 6,9-7,9	250	18+100	168,50





950 - Llave allen acodada Hex-Plus

Llave acodada de alta calidad para tornillos de hexágono interior. Hex-Plus ofrece mayores superficies de apoyo dentro de la cabeza del tornillo. Así se reduce a un mínimo el efecto de entalladura y la destrucción de la cabeza del tornillo se evita casi por completo. El cuidadoso tratamiento de cromado garantiza una alta protección anticorrosiva.

Ref.	Código	Entrecaras mm	a mm	b mm	€/ u.
8004558	05021005001	1.5	14	45	0,96
8004559	05021010001	2.0	16	50	0,96
8004560	05021015001	2.5	20	58	1,01
8004561	05021020001	3.0	20	63	1,26
8004562	05021025001	3.5	23	66	1,26
8004563	05021030001	4.0	25	70	1,55
8004564	05021035001	4.5	26	75	1,57
8004565	05021040001	5.0	28	80	1,81
8004566	05021045001	6.0	32	90	2,54
8004567	05021050001	7.0	34	95	3,27
8004568	05021055001	8.0	36	100	4,25
8004569	05021060001	9.0	38	106	4,76
8004570	05021065001	10.0	40	112	6,24
8004571	05021070001	11.0	43	120	8,20
8004572	05021075001	12.0	45	125	9,38
8004573	05021080001	13.0	50	132	13,30
8004574	05021085001	14.0	56	140	15,46
8004575	05021090001	17.0	63	160	25,89
8004576	05021095001	19.0	70	180	36,02

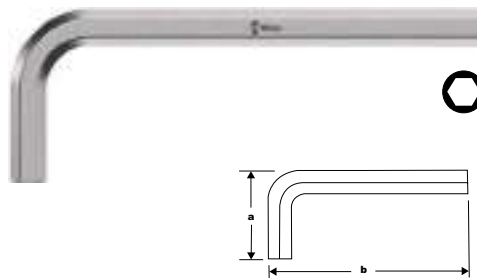

1995LM - Llave allen acodada, larga



DIN ISO 2936.

Ref.	Código	Entrecaras mm	a mm	b mm	€/ u.
1207500	1995LM-1.5	1.5	15	91	0,70
1207501	1995LM-2	2	18	102	0,51
1207502	1995LM-2.5	2.5	21	114	0,61
1207503	1995LM-3	3.0	23	129	0,80
1207504	1995LM-4	4.0	29	144	0,92
1207505	1995LM-5	5.0	33	165	1,35
1207506	1995LM-6	6.0	38	186	2,02
1207507	1995LM-7	7.0	41	197	2,66
1207508	1995LM-8	8.0	44	208	3,46
1207509	1995LM-9	9.0	47	219	4,32
1207510	1995LM-10	10	50	234	4,86
1207511	1995LM-12	12	57	262	7,29
1207512	1995LM-14	14	70	294	9,00

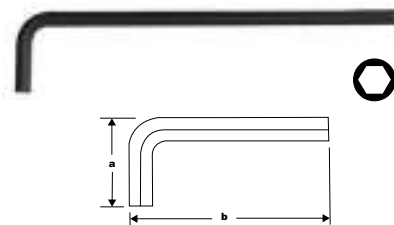

950 L- Llave allen acodada Hex-Plus, larga



Llave acodada de alta calidad para tornillos de hexágono interior. Hex-Plus ofrece mayores superficies de apoyo dentro de la cabeza del tornillo. Así se reduce a un mínimo el efecto de entalladura, y la destrucción de la cabeza del tornillo se evita casi por completo. El cuidadoso tratamiento de cromado garantiza una alta protección anticorrosiva. Con un brazo extra-largo.

Ref.	Código	Entrecaras mm	a mm	b mm	€/ u.
8004581	05021600001	1.5	14	90	1,49
8004582	05021605001	2.0	16	100	1,49
8004583	05021610001	2.5	18	112	1,49
8004584	05021615001	3.0	20	126	1,61
8004585	05021620001	4.0	25	140	1,69
8004586	05021625001	5.0	28	160	2,53
8004587	05021630001	6.0	32	180	3,39
8004588	05021632001	7.0	30	190	4,74
8004589	05021635001	8.0	36	200	5,73
8004590	05021640001	10.0	40	219	8,64
8004591	05021645001	12.0	45	250	13,64

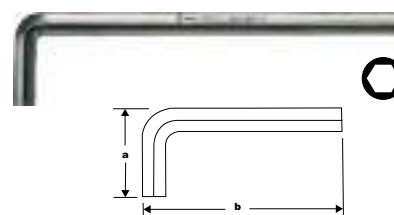



950 PKL - Llave allen acodada con punta bola

Llave acodada de alta calidad para tornillos de hexágono interior. Hex-Plus ofrece mayores superficies de apoyo dentro de la cabeza del tornillo. Así se reduce a un mínimo el efecto de entalladura, y la destrucción de la cabeza del tornillo se evita casi por completo. La bola en el brazo largo permite un trabajo seguro incluso en situaciones de trabajo complicadas. El cuidadoso tratamiento de cromado garantiza una alta protección anticorrosiva. Gracias a las marcas con el tamaño que están grabadas a láser de forma resistente y duradera, las llaves acodadas siempre se tienen a mano rápidamente.

Ref.	Código	Entrecaras mm	a mm	b mm	€ / u.
8004593	05022050001	1.5	15	90	3,54
8004594	05022052001	2.0	16	100	3,54
8004595	05022054001	2.5	20	113	3,96
8004596	05022056001	3.0	22	128	4,95
8004597	05022058001	4.0	28	143	4,95
8004598	05022060001	5.0	32	165	5,59
8004599	05022062001	6.0	38	187	6,45
8004600	05022063001	7.0	34	190	7,57
8004601	05022064001	8.0	43	216	8,95
8004602	05022066001	10.0	48	230	11,79
8004603	05022067001	12.0	45	248	16,21

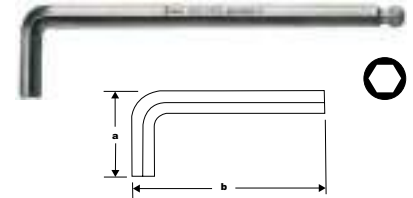

3950 PKL - Llave allen acodada con punta de bola, inoxidable



Ref.	Código	Entrecaras mm	a mm	b mm	€ / u.
1265100	05022700001	1,5	5	90	7,77
1265101	05022701001	2	5	101	7,16
1265102	05022702001	2,5	19	112	6,97
1265103	05022703001	3	21	123	6,78
1265104	05022704001	4	24	137	7,37
1265105	05022705001	5	27	154	8,93
1265106	05022706001	6	31	172	11,62
1265107	05022708001	8	37	195	14,51
1265108	05022709001	10	42	224	22,45

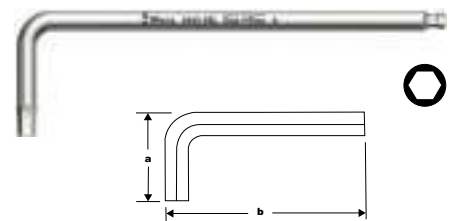

967 Llave allen acodada TORX®



Llave acodada de alta calidad para tornillos de TORX® interior. El tratamiento de superficie Black Laser proporciona una protección excelente de la superficie, también con relación a la corrosión, y garantiza una larga vida útil. Gracias a las marcas con el tamaño que están grabadas a láser de forma resistente y duradera, las llaves acodadas siempre se tienen a mano rápidamente.

Ref.	Código	Entrecaras	a mm	b mm	€ / u.
8004615	05024001001	T6	16	42	4,02
8004616	05024002001	T7	16	48	3,80
8004617	05024003001	T8	16	48	3,80
8004618	05024004001	T9	16	48	4,11
8004619	05024005001	T10	17	51	4,28
8004620	05024008001	T15	18	54	4,28
8004621	05024010001	T20	19	57	4,66
8004622	05024012001	T25	20	60	4,84
8004623	05024013001	T27	21	64	4,97
8004624	05024015001	T30	24	70	5,25
8004625	05024020001	T40	26	76	6,00

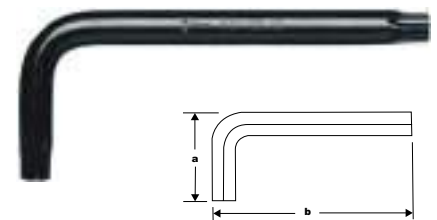

97BTX Llave allen acodada con punta bola, TORX®



01

Ref.	Código	Entrecaras	L1 mm	L mm	€/ u.
8005090	970109	T9	16	80	8,60
8005091	970110	T10	17	86	8,60
8005092	970115	T15	18	90	8,60
8005093	970120	T20	19	95	9,15
8005094	970125	T25	20	100	9,80
8005095	970127	T27	21	105	10,40
8005096	970130	T30	24	114	10,60
8005097	970140	T40	26	124	12,20
8005098	970145	T45	28	133	14,20
8005099	970150	T50	32	152	15,90
8005100	970155	T55	35	164	21,10



97BTXL Llave allen acodada con punta bola, larga, TORX®



Ref.	Código	Entrecaras	L1 mm	L mm	€/ u.
8005102	970309	T9	15	80	8,95
8005103	970310	T10	17	86	8,95
8005104	970315	T15	18	100	8,95
8005105	970320	T20	19	110	10,30
8005106	970325	T25	20	126	11,30
8005107	970327	T27	24	140	12,70
8005108	970330	T30	28	160	13,30
8005109	970340	T40	32	176	15,70

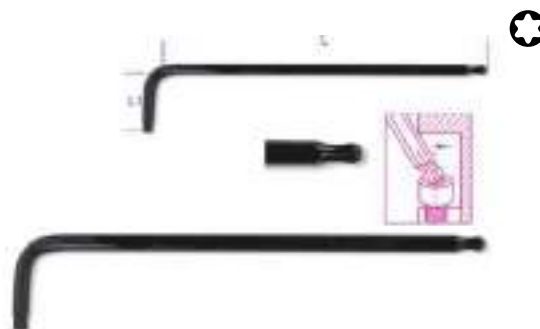

96BPA Llave allen acodada a 110° con punta bola, brazo extra-corto



Ángulo de 110° lado extra-corto

Ref.	Código	Entrecaras mm	L1 mm	L mm	€/ u.
8005080	961960	1,5	9	71	2,01
8005081	961961	2	11	86	2,06
8005082	961962	2,5	13	96	2,24
8005083	961963	3	15	104	2,69
8005084	961964	4	17	116	3,05
8005085	961965	5	19	132	3,45
8005086	961966	6	21	155	4,35
8005087	961968	8	24	176	6,50
8005088	961970	10	27	200	9,45



1999MV - Llave allen acodada, aislada



Ref.	Código	Entrecaras mm	A mm	B mm	€/ u.
1243900	1999MV-3	3	118.5	78.5	15,40
1243901	1999MV-4	4	118	78	15,95
1243902	1999MV-5	5	117.5	77.5	15,79
1243903	1999MV-6	6	117	87	16,10
1243904	1999MV-7	7	116.5	91.5	16,86
1243905	1999MV-8	8	116	100	17,81
1243906	1999MV-9	9	115.5	100	18,42
1243907	1999MV-10	10	115	110	19,97
1243908	1999MV-12	12	114	124	22,45





950 SPKL Llave allen acodada con punta bola, barnizada

Llave acodada de Wera de alta calidad, con camisa envolvente de goma confortable que lleva una codificación a color. Así la herramienta se puede seleccionar rápidamente. El mango ergonómico y agradable cuida las manos, incluso cuando hacen temperaturas muy bajas. El perfil Hex-Plus ofrece mayores superficies de apoyo dentro de la cabeza del tornillo. Así se reduce a un mínimo el efecto de entalladura y la destrucción de la cabeza del tornillo se evita casi por completo. La bola en el brazo largo permite un trabajo seguro incluso en situaciones de montaje complicadas. El tratamiento de superficie Black Laser proporciona una protección excelente de la superficie, también con relación a la corrosión, y garantiza una larga vida útil de la herramienta. Gracias a las duraderas marcas del tamaño grabadas a láser, las llaves siempre se tienen a mano rápidamente.

Ref.	Código	Entrecaras mm	Longitud	Brazo mm	Color	€ / u.
8004605	05022600001	1.5	93	17	Azul Claro	7,58
8004606	05022602001	2.0	104	19	Turquesa	6,97
8004607	05022604001	2.5	114	23	Verde Claro	6,88
8004608	05022606001	3.0	126	26	Fucsia Claro	6,70
8004609	05022608001	4.0	142	30	Amarillo	7,37
8004610	05022610001	5.0	160	34	Naranja Claro	8,87
8004611	05022612001	6.0	180	37	Rojo	11,51
8004612	05022614001	8.0	205	48	Fucsia	14,42
8004613	05022616001	10.0	237	54	Azul	18,99



Juego de llaves allen acodadas largas con punta bola



Niqueladas. Acero de cromo-vanadio.

Ref.	Código	Contenido	Composición	€ / u.
8004738	30999	9	1,5-2-2,5-3-4-5-6-8-10	16,05



950/9 HEX-PLUS Juego de llaves allen acodadas



Juego de llaves acodadas de alta calidad para tornillos de hexágono interior. Hex-Plus ofrece mayores superficies de apoyo dentro de la cabeza del tornillo. Así se reduce a un mínimo el efecto de entalladura y la destrucción de la cabeza del tornillo se evita casi por completo. El cuidadoso tratamiento de cromado en bastidor garantiza una alta protección anticorrosiva. Gracias a la marcación del tamaño grabada a láser, las llaves se seleccionan fácilmente. Con el práctico clip de material resistente y libre de desgaste que sostiene los útiles, las llaves siempre se tienen a mano rápidamente.

Ref.	Código	Contenido	Composición	€ / u.
8004580	05021406001	9	1,5-2-2,5-3-4-5-6-8-10	19,98



BE-9588 - Juego de llaves allen acodadas, largas



Ref.	Código	Contenido	Composición mm	€ / u.
1207601	BE-9588	9	1,5 - 2 - 2,5 - 3 - 4 - 5 - 6 - 8 - 10	20,67



950/9 HEX-PLUS - Juego de llaves allen acodadas, largas



Juego de llaves acodadas de alta calidad para tornillos de hexágono interior. Hex-Plus ofrece mayores superficies de apoyo dentro de la cabeza del tornillo. Así se reduce a un mínimo el efecto de entalladura, y la destrucción de la cabeza del tornillo se evita casi por completo. El cuidadoso tratamiento de cromado garantiza una alta protección anticorrosiva. Con brazos extra-largos.

Ref.	Código	Contenido	Composición	€ / u.
8004592	05021909001	9	1,5-2-2,5-3-4-5-6-8-10	26,30



950/9 HEX-PLUS - Juego de llaves allen acodadas con punta bola, largas



Juego de llaves acodadas de alta calidad para tornillos de hexágono interior, en el clip práctico de material resistente, para un alojamiento constantemente seguro y una extracción fácil de las llaves. Llaves acodadas con perfil Hex-Plus: éste ofrece mayores superficies de apoyo dentro de la cabeza del tornillo. Así se reduce a un mínimo el efecto de entalladura y la destrucción de la cabeza del tornillo se evita casi por completo. La bola en el brazo largo permite un trabajo seguro incluso en situaciones de montaje complicadas. El cuidadoso tratamiento de cromado en bastidor garantiza una alta protección anticorrosiva. Gracias a las duraderas marcas del tamaño grabadas a láser, las llaves se tienen a mano rápidamente.



Ref.	Código	Contenido	Composición	€ / u.
8004604	05022087001	9	1.5-2-2.5-3-4-5-6-8-10	45,59

96BPA/SC9 Juego de 9 llaves allen acodadas con punta bola, brazo extra-corto



Ángulo de 110° lado extra-corto

Ref.	Código	Descripción	Composición mm	€ / u.
8005089	961974	Ángulo de 110° lado extra-corto	1.5-2-2.5-3-4-5-6-8-10	40,50



950 HEX - PLUS MULTICOLOR - Juego de llaves allen acodadas con punta bola



Llave acodada con camisa envolvente de plástico (SPKL) elaborada de un material redondeado agradable al tacto y agarre. Esta camisa facilita el trabajo en ambientes de temperaturas bajas, lo hace más agradable y cuida los dedos. Todas las llaves acodadas llevan su codificación a color y sus marcas de tamaño, lo que facilita la selección rápida del útil correcto. El material del clip que es resistente al desgaste garantiza el alojamiento seguro y la extracción fácil de las llaves acodadas. Para tornillos de hexágono interior.



Ref.	Código	Contenido	Composición	€ / u.
8004614	05022089001	9	1.5-2-2.5-3-4-5-6-8-10	56,19

967/9 TX 1 - Juego de llaves allen acodadas TORX®



Juego de llaves acodadas de alta calidad para tornillos de TORX® interior. En parte con cabeza de bola: La bola en el brazo largo permite un trabajo seguro incluso en situaciones de montaje difíciles. El tratamiento de superficie Black Laser proporciona una protección excelente de la superficie, también con relación a la corrosión, y garantiza una larga vida útil. Gracias a las marcas con el tamaño que están grabadas a láser de forma resistente y duradera, las llaves acodadas se tienen a mano rápidamente. Se encuentran en el clip práctico de material resistente al desgaste, para un alojamiento duraderamente seguro y una extracción descomplicada de las llaves acodadas.



Ref.	Código	Contenido	Composición	€ / u.
8004626	05024242001	9	T8-T9-T10-T15-T20-T25-T27-T30-T40	52,21

97BTX/SC8 Juego de 8 llaves allen con punta bola TORX®



Ref.	Código	Composición	€ / u.
8005101	970164	T9-T10-T15-T20-T25-T27-T30-T40	82,50



3950/9 HEX-PLUS INOX Juego de llaves acodadas, largas, inoxidable



Ref.	Código	Contenido	Composición	€ / u.
1265200	05073544001	9	1,5-2-2,5-3-4-5-6-8-10	67,71



454 HF -Llave allen con mango en T



Destornillador hexagonal de mango en T para tornillos de hexágono interior. Hex-Plus ofrece unas superficies de apoyo mayores dentro de la cabeza del tornillo. Así, el efecto de entalladura es reducido a un mínimo, y la destrucción de la cabeza del tornillo se evita prácticamente del todo. La forma del mango es ideal y permite la transmisión de altos pares de apriete y desapriete. La forma ergonómica del mango cubre el pulpejo de la mano de forma completa, y los dedos se apoyan en las cavidades de agarre suavemente redondeadas. Así, toda la mano consigue estar en contacto con el mango, y así se logra evitar las pérdidas de fricción entre la mano y el mango.

Ref.	Código	Entrecaras mm	Longitud mm	Brazo mm	€ / u.
8005516	5023330001*	2	100	65	9,17
8005517	5023332001*	2,5	100	65	9,47
8005518	5023334001	3	100	77	12,71
8005519	5023338001	4	100	77	13,13
8005520	5023339001	4	150	77	13,31
8005521	5023340001	4	200	77	13,62
8005522	5023342001	5	100	99	14,27
8005523	5023343001	5	150	99	14,87
8005524	5023344001	5	200	99	15,47
8005525	5023346001	6	100	99	14,87
8005526	5023347001	6	150	99	15,47
8005527	5023348001	6	200	99	16,31
8005528	5023350001	7	200	99	15,14
8005529	5023351001	8	100	99	17,03
8005530	5023352001	8	150	99	18,00
8005531	5023353001	8	200	99	18,88
8005532	5023354001	10	100	99	19,31
8005533	5023355001	10	200	99	22,43



97TTX Llave allen con mango en T, TORX®



- Rápida y fácil de manejar • El mango es pequeño y está perfectamente equilibrado para girar rápidamente en la palma de la mano • La forma ergonómica permite utilizarla también para pares muy elevados
- Los extremos hexagonales están calibrados para transmitir al tornillo el máximo par posible • Hoja pasante dentro del mango

Ref.	Código	Entrecaras	L mm	L1 mm	S mm	€ / u.
8005111	970706	T6	130	52	13	12,60
8005112	970707	T7	130	52	13	12,60
8005113	970708	T8	139	52	13	12,70
8005114	970709	T9	139	52	13	12,80
8005115	970710	T10	179	70	13	13,20
8005116	970715	T15	179	70	13	14,80
8005117	970720	T20	179	70	18	14,80
8005118	970725	T25	179	70	18	15,40
8005119	970727	T27	200	84	22	17,10
8005120	970730	T30	200	84	22	18,60
8005121	970740	T40	221	103	24	20,60
8005122	970745	T45	236	106	26	24,30
8005123	970750	T50	255	117	26	32,00



97BTX/SC8 Juego de 8 llaves acodadas largas con cabeza bola, TORX®



Ref.	Código	Composición	€ / u.
2400069	970364	T9-T10-T15-T20-T25-T27-T30-T40	94,50



96TINOX Llave allen con mango, acero inoxidable



01

- Alta resistencia a la corrosión · Características mecánicas sobresalientes · Evita la oxidación incorrecta
- Extremos hexagonales calibrados para unir el tornillo perfectamente · El mango ergonómico proporcionado de manera precisa de acuerdo con el tamaño de la llave, da como resultado, un alto poder de apriete, por ejemplo, en espacios pequeños · Acero inoxidable AISI 420



Ref.	Código	Entrecaras mm	L mm	L1 mm	Ø mm	T mm	S mm	€/ u.
8005070	961935	2,5	153	55	3	6,0	13,6	14,20
8005071	961936	3	153	55	4	6,5	13,6	15,00
8005072	961938	4	179	70	5	7,5	18,0	16,70
8005073	961940	5	200	84	6	8,5	20,6	19,70
8005074	961941	6	221	95	7	9,0	25,2	24,50
8005075	961942	7	236	106	9	13,0	26,0	26,50
8005076	961943	8	255	117	10	14,0	26,0	31,50
8005077	961944	10	285	132	12	16,0	29,0	39,50

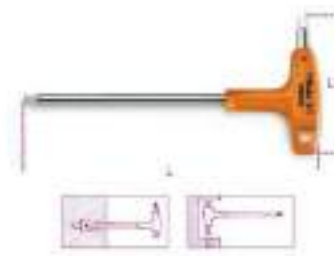

96TINOX/S8 Juego de 8 llaves allen acodadas con mango en T, acero inoxidable



- Alta resistencia a la corrosión · Características mecánicas sobresalientes · Evita la oxidación incorrecta
- Extremos hexagonales calibrados para unir el tornillo perfectamente · El mango ergonómico proporcionado de manera precisa de acuerdo con el tamaño de la llave, da como resultado, un alto poder de apriete, por ejemplo, en espacios pequeños · Acero inoxidable AISI 420



Ref.	Código	Composición mm	€/ u.
8005079	961954	2,5-3-4-5-6-7-8-10	187,50



96TINOX/S5 Juego de 5 llaves allen acodadas con mango en T, acero inoxidable



- Alta resistencia a la corrosión · Características mecánicas sobresalientes · Evita la oxidación incorrecta
- Extremos hexagonales calibrados para unir el tornillo perfectamente · El mango ergonómico proporcionado de manera precisa de acuerdo con el tamaño de la llave, da como resultado, un alto poder de apriete, por ejemplo, en espacios pequeños · Acero inoxidable AISI 420



Ref.	Código	Composición mm	€/ u.
8005078	961952	2,5-3-4-5-6	90,00



951 Llave en T con tres extremidades allen



Ref.	Código	Entrecaras mm	L mm	L1 mm	Ø mm	H mm	€/ u.
8005188	9510521	2	125	63	4,0	5,5	23,30
8005189	9510525	2,5	150	63	4,0	6	23,30
8005190	9510530	3	150	63	4,0	6,5	23,30
8005191	9510535	3,5	175	76	5,5	7,5	24,60
8005192	9510540	4	175	76	5,5	8	24,60
8005193	9510545	4,5	195	87	6,5	8,5	27,50
8005194	9510550	5	195	87	6,5	9	27,50
8005195	9510560	6	215	99	8,0	10	32,00
8005196	9510570	7	230	109	9,0	11	33,00
8005197	9510580	8	250	122	10,0	12	35,50
8005198	9510590	9	265	132	11,0	13	40,00
8005199	9510610	10	280	142	12,0	14	42,50
8005200	9510620	12	305	160	15,0	15	51,00
8005201	9510640	14	330	178	17,0	17	63,50

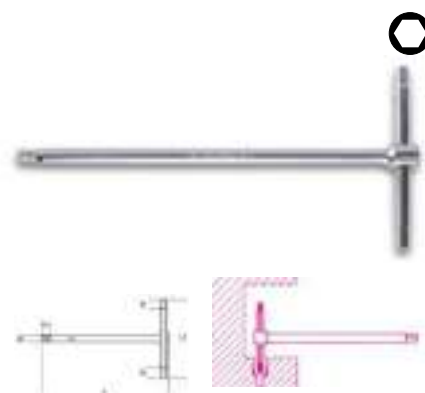

951/S6-Juego 6 llaves en T con tres extremidades



Ref.	Código	Composición mm	€ / u.
2400070	9510687	2-2,5-3-3,5-4-4,5-5-6	166,00



96TBP/S6 Llave allen acodada con cabeza bola y mango en T



Ref.	Código	Entrecaras mm	L mm	L1 mm	Ø mm	S mm	€ / u.
8005062	960685	2,5	153	55	4	13,4	12,70
8005063	960686	3	153	55	4	13,4	13,30
8005064	960687	4	179	70	5	17,8	13,90
8005065	960688	5	200	84	6	22,0	14,10
8005066	960689	6	221	103	7	24,0	15,10
8005067	960690	8	255	117	10	26,0	18,10
8005068	960692	10	285	132	12	27,6	20,60

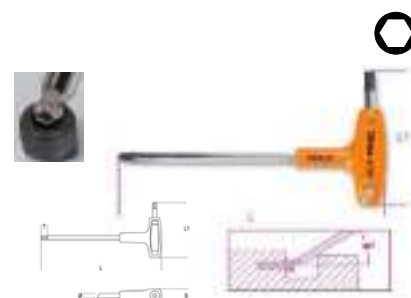

96TBP/S6 Juego de 6 llaves allen acodadas con cabeza bola y mango en T



Ref.	Código	Composición mm	€ / u.
8005069	960694	2,5-3-4-5-6-8	87,00



6700 - Llave de vaso 1/4"



ISO 2725 - 1174 - DIN 3124 - 3120. Acero especial tratado. Cromado. Boca hexagonal, perfil NPP. Para trabajo manual. No trabajar a impacto.

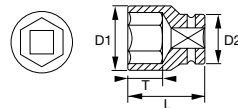

Ref.	Código	Entrecaras mm	D1 mm	D2 mm	L mm	€ / u.
1209200	6700SM-4	4	6.8	11.9	24.7	5,13
1209201	6700SM-4.5	4.5	7.4	11.9	24.7	5,13
1209202	6700SM-5	5	8.1	11.9	24.7	5,13
1209203	6700SM-5.5	5.5	8.7	11.9	24.7	5,13
1209204	6700SM-6	6	9.3	11.9	24.7	5,13
1209205	6700SM-7	7	10.8	11.9	24.7	5,13
1209206	6700SM-8	8	11.9	11.9	24.7	5,13
1209207	6700SM-9	9	13.4	12.4	24.7	5,13
1209208	6700SM-10	10	14.5	13	24.7	5,13
1209209	6700SM-11	11	15.9	14.1	24.7	5,13
1209210	6700SM-12	12	16.9	15	24.7	5,13
1209211	6700SM-13	13	18	15.6	24.7	5,13

Ref.	Código	Entrecaras mm	D1 mm	D2 mm	L mm	€ / u.
1209212	6700SM-14	14	19.6	16	24.7	5,13
1209301	6700SZ-5/32	5/32	6.8	11.9	24.7	5,21
1209302	6700SZ-3/16	3/16	7.9	11.9	24.7	5,21
1209303	6700SZ-7/32	7/32	8.9	11.9	24.7	5,21
1209304	6700SZ-1/4	1/4	9.9	11.9	24.7	5,21
1209305	6700SZ-9/32	9/32	11	11.9	24.7	5,21
1209306	6700SZ-5/16	5/16	11.9	11.9	24.7	5,21
1209307	6700SZ-11/32	11/32	13	12.4	24.7	5,21
1209308	6700SZ-3/8	3/8	14.5	13	24.7	5,21
1209309	6700SZ-7/16	7/16	15.9	14.1	24.7	5,21
1209310	6700SZ-1/2	1/2	17.6	15.2	24.7	5,21
1209311	6700SZ-9/16	9/16	19.6	16	24.7	5,21

2400 - Llave de vaso 1/4"



Ref.	Código	Entrecaras mm	Longitud mm	€ / u.
8001047	8K2400M3	3	22	4,03
8001048	8K2400M4	4	22	4,03
8001049	8K2400M4.5	4,5	22	3,66
8001050	8K2400M5	5	22	3,66
8001051	8K2400M5.5	5,5	22	3,66
8001052	8K2400M6	6	22	3,66
8001053	8K2400M7	7	22	3,66

Ref.	Código	Entrecaras mm	Longitud mm	€ / u.
8001054	8K2400M8	8	22	3,66
8001055	8K2400M9	9	22	3,87
8001042	8K2400M10	10	22	3,87
8001043	8K2400M11	11	22	4,22
8001044	8K2400M12	12	22	4,22
8001045	8K2400M13	13	22	4,39
8001046	8K2400M14	14	22	4,94

8790 HMA HF - Llave de vaso 1/4"



Llave de vaso Zyklop 1/4" con función retención



Ref.	Código	Entrecaras mm	Largo mm	Ancho mm	Alto mm	€ / u.
8004526	05003717001	4.0	23	7	11	8,20
8004527	05003718001	4.5	23	7,8	11	8,20
8004528	05003719001	5.0	23	8,9	11	8,20
8004529	05003720001	5.5	23	9,2	11	8,20
8004530	05003721001	6.0	23	10,5	11	8,70
8004531	05003722001	7.0	23	11,9	11	8,70
8004532	05003723001	8.0	23	12,9	11	8,70

Ref.	Código	Entrecaras mm	Largo mm	Ancho mm	Alto mm	€ / u.
8004533	05003724001	9.0	23	14,1	12	8,70
8004534	05003725001	10.0	23	15,6	12,5	8,97
8004535	05003726001	11.0	23	17,4	13	9,22
8004536	05003727001	12.0	23	18,4	14	9,22
8004537	05003728001	13.0	23	19,5	15	9,46
8004538	05003729001	14.0	23	20,8	16	9,46
21130026	05003010001	15.0	23	21,5	18,5	9,46



8790 FA - Llave de vaso Zyklop de 1/4"



Aplicación: para tornillos y tuercas de hexagonal exterior. Arrastre: de cuadrado de 1/4" y hexagonal de 11; adecuado para carracas de 1/4" y la Wera Zyklop Mini 2. Realización: para el uso manual; con ranura de retención de bola; un largo muy reducido, ideal para espacios de montaje estrechos; de cromo-vanadio, en cromo de alto brillo.



Ref.	Código	Entrecaras mm	Alto cuello mm	Longitud mm	Diametro Base mm	Diametro Cuello mm	€ / u.
1213026	05003666001	4,5	9,5	18,0	11,8	7,0	7,25
1213027	05003667001	5,0	9,5	18,0	11,8	7,6	7,25
1213028	05003668001	5,5	9,5	18,0	11,8	8,2	7,25
1213029	05003669001	6,0	9,5	18,0	11,8	9,2	7,25
1213030	05003670001	7,0	9,5	18,0	11,8	10,4	7,25
1213031	05003675001	8,0	9,5	18,0	11,8	11,5	7,25
1213032	05003690001	10,0	9,5	18,0	11,8	13,8	7,60
1213033	05003684001	12,0	9,5	18,0	11,8	16,8	7,95
1213034	05003685001	13,0	9,5	18,0	11,8	17,8	7,95



8740 A HF - Llave de vaso 1/4"



Llave de vaso Zyklop 1/4" con función retención



Ref.	Código	Entrecaras mm	Largo mm	Ancho mm	Alto mm	€ / u.
8005388	05003332001	3,0	100	44	22	14,27
8005389	05003333001	4,0	95	44	20	14,27
8005390	05003334001	4,0	170	44	22	17,30
8005391	05003335001	5,0	95	44	20	14,27
8005392	05003336001	5,0	170	44	20	17,30
8005393	05003337001	6,0	95	44	20	14,27

Ref.	Código	Entrecaras mm	Largo mm	Ancho mm	Alto mm	€ / u.
8005394	05003338001	6,0	170	44	20	17,30
8005395	05003341001	7,0	95	44	20	14,27
8005396	05003342001	7,0	167	44	22	17,30
8005397	05003339001	8,0	95	44	20	14,27
8005398	05003340001	8,0	170	44	22	17,30



A6700DM - Llave de vaso 1/4", bihexagonal



ISO 2725 - 1174 - DIN 3124 - 3120. Acero especial tratado. Cromado. Boca bihexagonal, perfil NPP. Para trabajo manual. No trabajar a impacto.

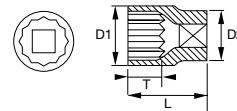

Ref.	Código	Entrecaras mm	D1 mm	D2 mm	L mm	T mm	€ / u.
1209401	A6700DM-5.5	5,5	8,7	11,9	24,7	8	5,13
1209402	A6700DM-6	6	9,3	11,9	24,7	8	5,13
1209403	A6700DM-7	7	10,8	11,9	24,7	8	5,13
1209404	A6700DM-8	8	11,9	11,9	24,7	8	5,13
1209405	A6700DM-9	9	13,4	12,4	24,7	8	5,13

Ref.	Código	Entrecaras mm	D1 mm	D2 mm	L mm	T mm	€ / u.
1209406	A6700DM-10	10	14,5	13	24,7	9	5,13
1209407	A6700DM-11	11	15,9	14,1	24,7	11,5	5,13
1209408	A6700DM-12	12	16,9	15	24,7	11,5	5,13
1209409	A6700DM-13	13	18	15,6	24,7	11,5	5,13
1209410	A6700DM-14	14	19,6	16	24,7	11,5	5,13

A6800DM - Llave de vaso 1/4" serie larga, bihexagonal



ISO 2725-1 - 1174-1 - DIN 3120. Acero especial tratado. Cromado. Boca bihexagonal, perfil NPP. Para trabajo manual. No trabajar a impacto.

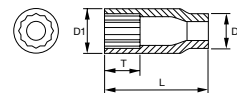

Ref.	Código	Entrecaras mm	D1 mm	D2 mm	L mm	T mm	€ / u.
1209500	A6800DM-4	4	6,7	12,1	50,6	4,6	12,05
1209502	A6800DM-5	5	7,7	12,1	50,6	5,1	12,05
1209503	A6800DM-5.5	5,5	8,3	12,1	50,6	5,3	12,05
1209504	A6800DM-6	6	9,3	12,1	50,6	5,9	12,05
1209505	A6800DM-7	7	10,5	12,1	50,6	6,6	12,05
1209506	A6800DM-8	8	11,5	12,1	50,6	8,1	12,05

Ref.	Código	Entrecaras mm	D1 mm	D2 mm	L mm	T mm	€ / u.
1209507	A6800DM-9	9	12,7	12,1	50,6	8,1	12,05
1209508	A6800DM-10	10	14,0	12,1	50,6	9,7	12,05
1209509	A6800DM-11	11	15,4	13,1	50,6	11,2	12,05
1209510	A6800DM-12	12	16,5	14,0	50,6	12,7	12,05
1209511	A6800DM-13	13	17,6	15,0	50,6	12,7	12,05
1209512	A6800DM-14	14	18,8	16,0	50,6	15,8	12,05

A6710DM - Vaso articulado, bihexagonal



ISO 1174 • DIN 3120. Acero especial tratado. Cromado. Boca bihexagonal, perfil NPP. Para trabajo manual. No trabajar a impacto.

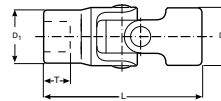

Ref.	Código	Entrecaras mm	D1 mm	D2 mm	L mm	T mm	€ / u.
1270800	A6710DM-5.5	5,5	8.4	12	30.5	5.5	41,58
1270801	A6710DM-6	6	9.0	12	31.0	6.0	41,58
1270802	A6710DM-7	7	10.3	12	32.0	6.5	41,58
1270803	A6710DM-8	8	11.5	12	33.0	7.0	41,58
1270804	A6710DM-9	9	12.8	12	34.5	8.0	41,58

Ref.	Código	Entrecaras mm	D1 mm	D2 mm	L mm	T mm	€ / u.
1270805	A6710DM-10	10	14.0	12	35.5	9.0	41,58
1270806	A6710DM-11	11	15.3	12	37.0	10.0	42,25
1270807	A6710DM-12	12	16.5	12	38.0	11.0	42,25
1270808	A6710DM-13	13	17.8	12	39.5	12.0	42,25
1270809	A6710DM-14	14	19.0	12	40.5	12.5	42,25

6700 TORX-E - Llave de vaso 1/4" TORX®



Acero especial. Tratado cromado.

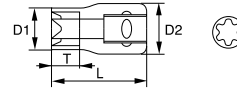

Ref.	Código	Punta torx	D1 mm	D2 mm	L mm	Para tornillo Métrica	€ / u.
1209600	6700TORX-E4	E4	5.4	12	25	M3	6,87
1209601	6700TORX-E5	E5	6.7	12	25	M4	6,87
1209602	6700TORX-E6	E6	7.7	12	25	M5	6,87

Ref.	Código	Punta torx	D1 mm	D2 mm	L mm	Para tornillo Métrica	€ / u.
1209603	6700TORX-E7	E7	8.3	12	25	M6	6,87
1209604	6700TORX-E8	E8	9.6	12	25	M6+M8	6,87
1209605	6700TORX-E10	E10	11.3	12	25	M6+M8	6,87

8767 A HF - Llave de vaso 1/4", TORX®



Llave de vaso Zyklop 1/4" con función retención



Ref.	Código	Entrecaras mm	Largo mm	Ancho mm	Alto mm	€ / u.
8005399	05003360001	TX 8	96	44	20	11,10
8005400	05003361001	TX 9	96	44	20	11,10
8005401	05003362001	TX 10	96	44	20	11,10
8005402	05003363001	TX 15	96	44	20	11,10
8005403	05003364001	TX 20	96	44	20	11,10
8005404	05003365001	TX 25	100	44	20	11,10
8005405	05003366001	TX 25	170	44	22	13,88

Ref.	Código	Entrecaras mm	Largo mm	Ancho mm	Alto mm	€ / u.
8005406	05003367001	TX 27	100	44	20	11,10
8005407	05003368001	TX 27	170	44	24	13,88
8005408	05003369001	TX 30	100	44	20	11,10
8005409	05003370001	TX 30	170	44	20	13,88
8005410	05003371001	TX 40	100	44	20	11,10
8005411	05003372001	TX 40	170	44	20	13,88

679 - Llave CROWFOOT 1/4"



Llave Crowfoot 1/4", para racores|Según normas ISO 1174 y DIN 3120|Material: Aleación de acero de alto rendimiento|El acabado cromado brillante proporciona una superficie de gran calidad



Ref.	Código	A mm	B mm	C mm	Cuadradillo interior "	€ / u.
1270900	679-10	13.5	18.2	7.1	1/4	50,06
1270901	679-12	14.0	20.6	9.0	1/4	50,47
1270902	679-13	14.0	22.2	10.0	1/4	50,71
1270903	679-14	14.0	22.2	11.0	1/4	54,60

6960 - Extensiones 1/4"



UNE 16511 · ISO 3316 - 1174 · DIN 3122 - 3123 - 3120. Acero especial tratado. Cromada.

Ref.	Código	Longitud mm	€ / u.
1210000	6960	50	8,98

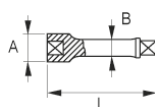

6972H - Vaso adaptador portapuntas 1/4"



UNE 16503 · ISO 1173 · DIN 3121-G 6,3 - 7427 Form A. Acero aleado especial tratado. Cromado. Retención de la punta. Especial para trabajar con puntas de 1/4".

Ref.	Código	Cuadrado interior"	D1 mm	D2 mm	Hexágono exterior mm	Longitud mm	€ / u.
1210600	6972H	1/4"	13.0	13.0	1/4"	26.0	22,59

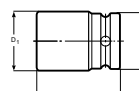

6954 - Mango corredizo 1/4"



UNE 16512 · ISO 3315 - 1174 · DIN 3122 - 3123 - 3120 . Acero especial tratado. Cromado.

Ref.	Código	Longitud mm	€ / u.
1210200	6954	115	11,63



6966 - Articulación universal 1/4"



UNE 16511 · ISO 3316 - 1174 · DIN 3122 - 3123 - 3120 . Acero especial tratado cromado. Mantiene la posición deseada mediante freno.

Ref.	Código	Longitud mm	€ / u.
1210300	6966	32,5	23,63

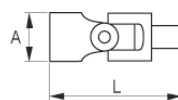

7765 - Ampliador 1/4"-3/8"



UNE 16503 · ISO 1174 · DIN 3120. Acero aleado especial. Tratado cromado.

Ref.	Código	Cuadrado interior"	Cuadrado Exterior	Longitud mm	€ / u.
1210400	7765	1/4	3/8	25	10,24

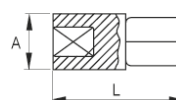

7767- Ampliador plano 1/4"-3/8"



ISO 1174 · DIN 3120 · UNE 16503.

Ref.	Código	Cuadrado interior "	Cuadrado Exterior	Longitud mm	€ / u.
1210500	7767	1/4	3/8	3.0	24,17



6950 - Carraca reversible 1/4"



UNE 16512 · ISO 3315 - 1174-2 · DIN 3122 - 3120. Acero cromo vanadio tratado. Rueda de 72 dientes.

Ref.	Código	Longitud mm	€ / u.
1209800	6950	120	40,82

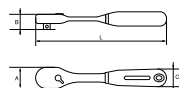

Carraca Zyklop Mini 2



Realización: Construcción de acero macizo forjado en matriz; mecánica de precisión de 60 dientes finos; pequeño ángulo de retorno de tan sólo 6°; conmutación de la dirección de giro de izquierda a derecha - y al revés - por medio de la lengüeta de cambio Mango: El mango tipo "Kraftform", con su geometría probada, ofrece una superficie de apoyo perfecta para los dedos de la mano; el cabezal de la carraca y la lengüeta disponen de una forma constructiva ergonómica

Ref.	Código	Longitud mm	Aplicación	€ / u.
1213895	05003660001	107	Adecuada para vasos de Wera 8790 FA	65,66



8000 A - Carraca Zyklop Speed 1/4"



Con la carraca Zyklop usted tendrá 5 tipos de carraca en una sola (carraca con dentado fino, carraca articulada, carraca flexible, carraca con bloqueo de vaso, carraca de potencia), e incluso puede utilizarla como si fuera un destornillador.

Ref.	Código	Longitud mm	Descripción	€ / u.
1209850	05003500001	152	Cabeza giratoria	106,18





Juego de llaves de vaso 1/4"



Ref.	Código	Piezas	Contenido	€ / u.
1210800	○ 6712R	12	6700SM (4 5 5.5 6 7 8 10 11 13 mm) , 6950, 6960, 6962	125,40
1210801	○ 6712RN	12	6700SM (4 5 5.5 6 7 8 10 11 13 mm) , 6950RN, 6960, 6962	120,37
1210802	○ A6716DM	15	A6700DM (5.5 6 7 8 9 10 11 12 13 14 mm) , 6950, 6954, 6956, 6960, 6966	153,56
1210810	○ 6715MGS	16	6700SM (4 4.5 5 5.5 6 7 8 9 10 11 13 mm) , 6950RN, 6954, 6956, 6962, 6966	166,88
1210811	○ 6719SM	17	6700SM (4 4.5 5 5.5 6 7 8 9 10 11 12 13 mm) , 6950, 6954, 6956, 6960, 6966	170,20
1210812	○ 6715MG	20	6700SM (4 4.5 5 5.5 6 7 8 9 10 11 12 13 14 mm) , 6950RN, 6954, 6956, 6958, 6960, 6962, 6966	205,49
1210813	○ 6721NM	21	6700SM (4 4.5 5 5.5 6 7 8 9 10 11 12 13 14 mm) , 6950, 6951, 6954, 6956, 6958, 6960, 6962, 6966	278,06
1210814	○ 6722M	27	6700SM (4 5 6 7 8 9 10 11 13 14 mm) , 6950, 6954, 6956, 6960, 6962, 6966. . 50MH (0.6x4 1x6, 1x7), 52H (PH No. 1 2 3), 55M (3 4 5 6 mm), 6972H	226,83
1210815	○ 6715GE	27	6700SM (4 5 6 7 8 9 10 11 13 14 mm) , 6950RN, 6954, 6956, 6960, 6962, 6966. . 50MH (0.6x4 1x6, 1x7), 52H (PH No. 1 2 3), 55M (3 4 5 6 mm), 6972H	223,49
1210816	○ 6715PZ	29	6700SM (4 4.5 5 5.5 6 7 8 9 10 11 12 13 mm) , 6950, 6954, 6956, 6960, 6962, 6966. . 6709M (0.6x4.5 1.0x5.5 1.2x8.0 mm), 6709PZ (No. 1 2 3), 6709F (3 4 5 6 8 mm)	255,22
1210817	○ 6715GJ	29	6700SM (4 4.5 5 5.5 6 7 8 9 10 11 12 13 mm) , 6950, 6954, 6956, 6960, 6962, 6966. . 6709F (3 4 5 6 8 mm), 6709PH (PH 1 2 3), 6709M (0.6x4.5 1.0x5.5 1.2x8.0 mm)	256,16
1210818	○ 6720NM	33	6700SM (4 4.5 5 5.5 6 7 8 9 10 11 12 13 14 mm) , 6950, 6954, 6956, 6962, 6966. . 1931M (4 4.5 5 5.5 6 7 8 9 10 11 12 13 14 mm), 221 MP, 7372 (0.5x3x80 mm)	311,37
1210803	○ S160	16	Vasos hexagonales con Perfil Dynamic Drive 4 4,5 5 5,5 6 7 8 9 10 11 12 13 mm. Llave de carraca de 45 dientes. Mango en T de 4". Barra de extensión de 3". Barra de extensión flexible de 6"	49,44

8100 SA 2 - Juego de carraca Zyklop Speed con arrastre 1/4", métrico



Ref.	Código	Contenido	€ / u.
1271000	05003533001	<p>En resistente caja metálica, juego de 42 piezas. 1 carraca Zyklop con arrastre de 1/4". 13 llaves de vaso Zyklop. 2 extensiones (corta y larga) Zyklop "sistema bloqueo flexible" con manguito de giro rápido. 1 extensión tipo "Wobble". 1 mango en "T". 1 articulación cardán. 1 adaptador con porta-puntas de cambio rápido. 22 puntas.</p> <ul style="list-style-type: none"> ○ 8000 A 1 x 1/4" x 152,0 ⊖ 800/1 Z 1 x 0,6x4, 5X25; 1 x 1,0x5,5x25; 1 x 1,2x8,0x25 ⊕ 840/1 Z. Hez-Plus 1 x 3,0x25; 1 x 4,0x25; 1 x 5,0x25; 1 x 6,0x25; 1 x 8,0x25 ⊕ 851/1 Z PH 1 x PH 1x25; 1 x PH 2x25; 1 x PH 3x25 ⊕ 855/1 Z PZ 1 x PZ 1x25; 1 x PZ 2x25; 1 x PZ 3x25 ⊕ 867/1 Z Torx® BO 1 x TX 8x25; 1 x TX 9x25; 1 x TX 10x25; 1 x TX 15x25; . 1 x TX 20x25; 1 x TX 25x25; 1 x TX 30x25; 1 x TX 40x25 ⊕ 8784 A1 1 x 1/4" x 1/4" x 37,0 ○ 8789 A 1 x 1/4" x 110,0 ● 8790 HMA 1 x 4,0x23,0; 1 x 4,5x23,0; 1 x 5,0x23,0; 1 x 5,5x23,0; . 1 x 6,0x23,0; 1 x 7,0x23,0; 1 x 8,0x23,0; 1 x 9,0x23,0; . 1 x 10,0x23,0; 1 x 11,0x23,0; 1 x 12,0x23,0; 1 x 13,0x23,0.1 x 14,0x23,0 ○ 8794 A 1 x 1/4" x 56,0 ○ 8795 A 1 x 1/4" x 35,5 ○ 8796 LA 1 x 1/4" x 150,0 ○ 8796 SA 1 x 1/4" x 75,0 	404,78



Juego de llaves de vaso y puntas 1/4"



Ref.	Código	Piezas	Contenido	€ / u.
1210900	SL24	24	Vasos con perfil Dynamic-Drive™ (4, 5, 6, 7, 8, 10 mm). Carraca de 1/4" compacta. Puntas de 1/4" planas 4,5 mm. Puntas de 1/4" Phillips® PH 1, 2, 3. Puntas Hexagonales 4,5 mm. Vaso con punta de bloqueo 1/4" x 1/4". Puntas Torx® (10, 15, 20, 25mm). Puntas de 1/4" Pozidriv® PZ 1, 2, 3, 1/4". Articulación universal para trabajos delicados. 1/4" alargadera de bloqueo, longitud 100 mm.	43,21
1210901	SL25	25	1/4" 6-pt vasos de perfil Dynamic-Driver (4, 4,5, 5, 5,5, 6, 7, 8, 9, 10, 11, 12, 13 mm). Carraca 1/4" con longitud de 125 mm. Punta 1/4" Phillips ph2. Punta hex 5, 6. Punta Torx® 10, 15, 20, 25 30, 40. Portapuntas. Cuadrado femenino de 1/4" con bloqueo. Extensión angular de 1/4", longitud 100 mm.	42,83
1210902	S290	29	Vasos hexagonales con perfil dynamic drive (4, 4,5 5, 5,5 6 7 8 9 10 11 12 13 mm). Vasos para tornillos Phillips® ph 1 2 3, 1/4". Vasos para tornillos ranurados (4 5,5 7 mm). 1/4" vasos para tornillos hexagonales (3 4 5 6 8 mm). 1/4" barra de extensión de 2". 1/4" barra de extensión de 6". 1/4" mango en T, 1/4" junta universal cardan. 1/4" extensión con mango. 1/4" llave de carraca de 45 dientes.	71,58
1210903	S460	46	Vasos hexagonales con perfil Dynamic Drive (4 4,5 5 5,5 6 7 8 9 10 11 12 13 mm). 1/4" vasos para tornillos Phillips® PH(1 2 3 4mm). 1/4" vasos para tornillos ranurados (4 5,5 7 mm). 1/4" vasos para tornillos hexagonales (3 4 5 6 8 10 mm). 1/4" vasos para tornillos Torx® (T 8 10 15 20 25 27 30). 1/4" vasos Torx® E 6 7 8. 1/4" disco giratorio. 1/4" barras de extensión de 2" y 4". 1/4" mango en T, 1/4" junta universal cardan. 1/4" extensión con mango. 1/4" extensión flexible de 6". 1/4" llave de carraca de 45 dientes. Llaves hexagonales 1,5 2 2,5 mm	110,91

Belt A1 Juego HF de llaves de vaso 1/4"



Juego de vasos 1/4" con función retención

Ref.	Código	Piezas	Contenido	Largo mm	€ / u.
8004553	05003880001	9	8790 HMA HF 1 x 4.0x23.0; 1 x 4.5x23.0; 1 x 5.0x23.0; 1 x 5.5x23.0; 1 x 6.0x23.0; 1 x 7.0x23.0; 1 x 8.0x23.0; 1 x 10.0x23.0; 1 x 13.0x23.0; 1 x 14.0x43.0; Belt A 0/9 1 x 39.0x238.0; 30 1 x 30.0x200.0;	265	89,25



Belt A2 Juego HF de vasos de punta hexagonal 1/4"



Juego de vasos 1/4" con puntas hexagonales, con función retención

Ref.	Código	Piezas	Contenido	Largo mm	€ / u.
8005412	05003881001	8	8740 A 1 x 2.0x28.0; 1 x 2.5x28.0; 8740 A HF 1 x 3.0x28.0; 1 x 4.0x28.0; 1 x 5.0x28.0; 1 x 6.0x28.0; 1 x 7.0x28.0; 1 x 8.0x28.0; Belt A 0/8 1 x 39.0x220.0; 30 1 x 30.0x200.0;	266	117,28



Belt A3 - Juego HF de llaves de vaso de punta TORX® de 1/4"



Juego de vasos 1/4" con puntas TORX y con función retención

Ref.	Código	Piezas	Contenido	Largo mm	€/ u.
8005413	05003882001	9	8767 A HF 1 x TX 8x28.0; 1 x TX 9x28.0; 1 x TX 10x28.0; 1 x TX 15x28.0; 1 x TX 20x28.0; 1 x TX 25x28.0; 1 x TX 27x28.0; 1 x TX 30x28.0; 1 x TX 40x28.0; Belt A 0/9 1 x 39.0x238.0; 30 1 x 30.0x200.0;	265	110,58



8100 SA 6 - Juego de carraca Zyklop Speed, cuadradillo de 1/4"



Juego de 28 piezas; en caja compacta de material textil para la protección de superficies, de gran robustez. Peso y volumen reducidos facilitan la movilidad. 1 carraca Zyklop Speed con cuadradillo de 1/4", 9 vasos Zyklop, 1 prolongación Zyklop (larga) con manguito de giro rápido, 1 prolongación "Wobble", 1 adaptador porta-puntas de cambio rápido, 15 puntas

Ref.	Código	Contenido	€/ u.
1213880	05004016001	8000 A 1 x 1/4" x 152,0	215,65
		800/1Z 1 x 0,6x4, 5x25; 1 x 1,0x5,5x25; 1 x 1,2x8,0x25	
		840/1Z Hez-Plus 1 x 3,0x25; 1 x 4,0x25; 1 x 5,0x25; 1 x 6,0x25; 1 x 8,0x25	
		851/1Z PH 1 x PH 1x25; 1 x PH 2x25; 1 x PH 3x25	
		855/1Z PZ 1 x PZ 1x25; 1 x PZ 2x25; 1 x PZ 3x25	
		867/1Z Torx® BO 1 x TX 8x25; 1 x TX 9x25; 1 x TX 10x25; 1 x TX 15x25; 1 x TX 20x25; 1 x TX 25x25; 1 x TX 30x25; 1 x TX 40x25	
		8784 A1 1 x 1/4" x 1/4" x 37,0	
		8789 A 1 x 1/4" x 110,0	
		8790 HMA 1 x 4,0x23,0; 1 x 4,5x23,0; 1 x 5,0x23,0; 1 x 5,5x23,0; 1 x 6,0x23,0; 1 x 7,0x23,0; 1 x 8,0x23,0; 1 x 9,0x23,0; 1 x 10,0x23,0; 1 x 11,0x23,0; 1 x 12,0x23,0; 1 x 13,0x23,0; 1 x 14,0x23,0	
		8794 A 1 x 1/4" x 56,0	
		8795 A1 x 1/4" x 35,5	
		8796 LA 1 x 1/4" x 150,0	
		8796 SA 1 x 1/4" x 75,0	

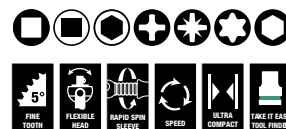

8100 SA All-in Juego de llaves de carraca Zyclop speed, cuadradillo de 1/4", con función retención



Juego de vasos, vasos con puntas hex y Tx con retención y planas, Ph y Pz

Ref.	Código	Contenido	€/ u.
8004557	05003755001	8000 A 1 x 1/4"x152.0; 8796 LA 1 x 1/4"x150.0; 8794 A 1 x 1/4"x56.0; 8790 HMA HF 1 x 4.0x23.0; 1 x 4.5x23.0; 1 x 5.0x23.0; 1 x 5.5x23.0; 1 x 6.0x23.0; 1 x 7.0x23.0; 1 x 8.0x23.0; 1 x 9.0x23.0; 1 x 10.0x23.0; 1 x 11.0x23.0; 1 x 12.0x23.0; 1 x 13.0x23.0; 1 x 14.0x23.0; 8767 A HF 1 x TX 8x28.0; 1 x TX 9x28.0; 1 x TX 10x28.0; 1 x TX 15x28.0; 1 x TX 20x28.0; 1 x TX 25x28.0; 1 x TX 27x28.0; 1 x TX 30x28.0; 1 x TX 40x28.0; 8740 A 1 x 2.0x28.0; 1 x 2.5x28.0; 8740 A HF 1 x 3.0x28.0; 1 x 4.0x28.0; 1 x 5.0x28.0; 1 x 6.0x28.0; 1 x 7.0x28.0; 1 x 8.0x28.0; 8751 A 1 x PH 1x28.0; 1 x PH 2x28.0; 1 x PH 3x28.0; 8755 A 1 x PZ 1x28.0; 1 x PZ 2x28.0; 1 x PZ 3x28.0; 8700 A FL 1 x 0.8x5.5x28.0; 1 x 1.2x6.5x28.0; Mutterentnahme-Werkzeug 1 x 14.0x43.0;	393,73



7400SM - Llave de vaso 3/8"



UNE 16507 · ISO 2725 · DIN 3124. Acero especial tratado. Cromada. Para trabajo manual. No trabajar a impacto.

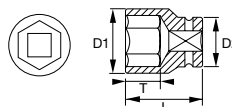

Ref.	Código	Entrecaras mm	D1 mm	D2 mm	L mm	€/ u.	Ref.	Código	Entrecaras mm	D1 mm	D2 mm	L mm	€/ u.
1211000	7400SM-6	6	9.3	17	25.5	5,58	1211009	7400SM-15	15	20.9	19	27	7,16
1211001	7400SM-7	7	10.9	17	25.5	5,58	1211010	7400SM-16	16	22	20	27	7,56
1211002	7400SM-8	8	11.8	17	25.5	5,68	1211011	7400SM-17	17	24.5	20	27	7,74
1211003	7400SM-9	9	13.4	17	25.5	5,90	1211012	7400SM-18	18	24.5	20	27	7,92
1211004	7400SM-10	10	14.6	17	25.5	6,12	1211013	7400SM-19	19	25.6	21	29	8,24
1211005	7400SM-11	11	15.9	17	25.5	6,20	1211014	7400SM-20	20	26.8	24	29	8,46
1211006	7400SM-12	12	17	17	25.5	6,29	1211015	7400SM-21	21	27.9	24	29	8,71
1211007	7400SM-13	13	18.4	17	25.5	6,45	1211016	7400SM-22	22	29.6	26	31	8,85
1211008	7400SM-14	14	19.6	18.4	27	6,89							



3400 - Llave de vaso 3/8"



Ref.	Código	Entrecaras mm	L mm	€/ u.
8001071	8K3400M5	5	26	4,76
8001072	8K3400M6	6	26	4,76
8001073	8K3400M7	7	26	4,76
8001074	8K3400M8	8	26	4,76
8001075	8K3400M9	9	26	4,76
8001056	8K3400M10	10	26	4,76
8001057	8K3400M11	11	26	4,76
8001058	8K3400M12	12	26	4,76
8001059	8K3400M13	13	26	5,58
8001060	8K3400M14	14	27	5,58

Ref.	Código	Entrecaras mm	L mm	€/ u.
8001061	8K3400M15	15	28	5,58
8001062	8K3400M16	16	28	5,58
8001063	8K3400M17	17	29	5,58
8001064	8K3400M18	18	30	5,58
8001065	8K3400M19	19	30	5,78
8001066	8K3400M20	20	31	7,20
8001067	8K3400M21	21	32	7,20
8001068	8K3400M22	22	32	7,20
8001069	8K3400M23	23	33	7,78
8001070	8K3400M24	24	34	7,93

8790 HMB HF - Llave de vaso 3/8"



Llave de vaso Zyklop 3/8" con función retención



Ref.	Código	Entrecaras mm	Largo mm	Ancho mm	Alto mm	€/ u.
8004539	05003740001	6.0	96	44	20	9,79
8004540	05003741001	7.0	96	44	20	9,79
8004541	05003742001	8.0	96	44	20	9,79
8004542	05003743001	9.0	96	44	20	9,79
8004543	05003744001	10.0	96	44	20	9,79
8004544	05003745001	11.0	96,3	46,1	20	9,79
8004545	05003746001	12.0	96	44	20	9,79

Ref.	Código	Entrecaras mm	Largo mm	Ancho mm	Alto mm	€/ u.
8004546	05003747001	13.0	96	44	20	10,11
8004547	05003748001	14.0	96	44	21	10,66
8004548	05003749001	15.0	96	44	24	10,66
8004549	05003750001	16.0	96	44	24	10,66
8004550	05003751001	17.0	96	44	26	10,66
8004551	05003752001	18.0	96	44	26	10,66
8004552	05003753001	19.0	96	44	28	10,79

A7400DZ - Llave de vaso 3/8", bihexagonal



UNE 16507 • ISO 2725 • DIN 3124. Acero especial tratado. Cromada. Para trabajo manual. No trabajar a impacto.

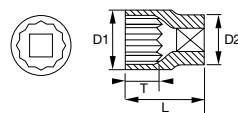

Ref.	Código	Entrecaras mm	D1 mm	D2 mm	L mm	T mm	€/ u.
1211100	A7400DM-6	6	9.3	17	25.5	7	7,44
1211101	A7400DM-7	7	10.9	17	25.5	7	7,44
1211102	A7400DM-8	8	11.8	17	25.5	8	7,44
1211103	A7400DM-9	9	13.4	17	25.5	8	7,44
1211104	A7400DM-10	10	14.6	17	25.5	8	7,44
1211105	A7400DM-11	11	15.9	17	25.5	8	7,44
1211106	A7400DM-12	12	17.0	17	25.5	8.5	7,44
1211107	A7400DM-13	13	18.4	17	25.5	8.5	7,44
1211108	A7400DM-14	14	19.6	19	27	13	7,44

Ref.	Código	Entrecaras mm	D1 mm	D2 mm	L mm	T mm	€/ u.
1211109	A7400DM-15	15	20.9	19	27	13	7,55
1211110	A7400DM-16	16	22	20	27	13	7,55
1211111	A7400DM-17	17	13.4	20	27	13	7,55
1211112	A7400DM-18	18	24.5	20	27	13	7,55
1211113	A7400DM-19	19	25.6	21	29	14	7,55
1211114	A7400DM-20	20	26.8	24	29	14	7,55
1211115	A7400DM-21	21	27.9	24	29	14	7,64
1211116	A7400DM-22	22	29.6	26	31	16	7,64



A7400DZ - Llave de vaso 3/8", bihexagonal, pulgadas



UNE 16507 · ISO 2725 · DIN 3124. Acero especial tratado. Cromada. Para trabajo manual. No trabajar a impacto.

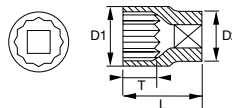

Ref.	Código	Entrecaras "	D1 mm	D2 mm	L mm	T mm	€ / u.
1211200	A7400DZ-1/4	1/4	10	17	25.5	7	8,10
1211201	A7400DZ-5/16	5/16	11.8	17	25.5	8	8,10
1211202	A7400DZ-3/8	3/8	14.3	17	25.5	8	8,10
1211203	A7400DZ-7/16	7/16	16	17	25.5	8	8,24
1211204	A7400DZ-1/2	1/2	18.4	17	25.5	8.5	8,24
1211205	A7400DZ-9/16	9/16	20.2	18.4	27	13	8,24

Ref.	Código	Entrecaras "	D1 mm	D2 mm	L mm	T mm	€ / u.
1211206	A7400DZ-5/8	5/8	22	20	27	13	8,36
1211207	A7400DZ-11/16	11/16	23.9	20	27	13	8,36
1211208	A7400DZ-3/4	3/4	25.6	21	29	14	8,36
1211209	A7400DZ-13/16	13/16	27.9	24	29	14	8,36
1211210	A7400DZ-7/8	7/8	30	26	31	16	8,36

A7400 TORX-E- Llave de vaso 3/8", TORX®



UNE 16507 · ISO 2725 · DIN 3124. Acero especial tratado. Cromada. Para trabajo manual. No trabajar a impacto.

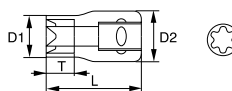

Ref.	Código	Punta torx	D1 mm	D2 mm	L mm	Para tornillo Métrica	€ / u.
1211480	7400TORX-E10	E10	12.3	17	31	M6+M8	10,88
1211481	7400TORX-E11	E11	13.3	17	31	-	10,88
1211482	7400TORX-E12	E12	14.3	17	31	M8+M1	10,88

Ref.	Código	Punta torx	D1 mm	D2 mm	L mm	Para tornillo Métrica	€ / u.
1211483	7400TORX-E14	E14	15.8	17	31	M10+M12	11,89
1211484	7400TORX-E16	E16	19.6	19	31	-	11,89
1211485	7400TORX-E18	E18	21	21	31	M12+M14	12,48

8740 B HF - Llave de vaso 3/8"



Llave de vaso Zyklop 3/8" con función retención



Ref.	Código	Entrecaras mm	Largo mm	Ancho mm	Alto mm	€ / u.
8005414	05003030001	3.0	102	44	20	14,90
8005415	05003031001	4.0	102	44	20	14,90
8005416	05003032001	4.0	180	44	20	18,29
8005417	05003033001	5.0	102	44	20	14,90
8005418	05003034001	5.0	175	45	22	18,29
8005419	05003035001	6.0	102	44	20	14,90
8005420	05003036001	6.0	174	44	19	18,29
8005421	05003037001	7.0	105	44	20	14,90

Ref.	Código	Entrecaras mm	Largo mm	Ancho mm	Alto mm	€ / u.
8005422	05003038001	7.0	167	46	22	18,29
8005423	05003039001	8.0	106	44	20	14,90
8005424	05003040001	8.0	170	44	20	18,29
8005425	05003041001	9.0	106	44	20	15,40
8005426	05003042001	9.0	101	44	20	19,43
8005427	05003043001	10.0	106	44	20	15,40
8005428	05003044001	10.0	169	44	20	19,43

7406ZZ - Llave de vaso 3/8" para bujías



Ref.	Código	Entrecaras mm	d mm	D2 mm	L mm	€ / u.
1271200	7406ZZ-21	21	27	27	65	31,97

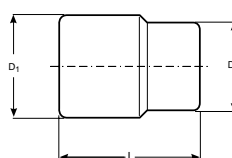

A7402 - Llave de vaso 3/8", serie larga



ISO 2725-1 - 1174-1 - DIN 3120. Acero aleado especial tratado. Cromada. Perfil NPP. Para trabajo manual, no trabajar a impacto.

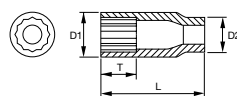

Ref.	Código	Entrecaras mm	D1 mm	D2 mm	L mm	T mm	€/ u.
1211403	A7402DM-10	10	14.3	17.3	56	9.7	14,92
1211404	A7402DM-11	11	15.8	17.3	56	11.2	14,92
1211405	A7402DM-12	12	16.6	17.3	56	12.7	14,92
1211406	A7402DM-13	13	18.0	17.3	60	12.7	14,92
1211407	A7402DM-14	14	19.6	18.0	60	15.5	15,61
1211408	A7402DM-15	15	20.4	19.0	60	15.5	15,61
1211409	A7402DM-16	16	21.1	20.0	60	15.5	15,61
1211410	A7402DM-17	17	22.8	20.0	60	15.5	16,64
1211411	A7402DM-18	18	24.3	21.0	60	18.5	16,64
1211412	A7402DM-19	19	25.1	22.0	60	18.5	16,64
1211450	A7402DZ-1/4	1/4	10.0	17.3	56	5.8	16,76

Ref.	Código	Entrecaras mm	D1 mm	D2 mm	L mm	T mm	€/ u.
1211451	A7402DZ-5/16	5/16	11.4	17.3	56	7.4	16,76
1211452	A7402DZ-3/8	3/8	14.3	17.3	56	10.2	16,76
1211453	A7402DZ-7/16	7/16	15.7	17.3	56	11.2	16,76
1211454	A7402DZ-1/2	1/2	18.0	17.3	60	12.7	16,76
1211455	A7402DZ-9/16	9/16	19.6	18.0	60	15.5	16,76
1211456	A7402DZ-19/32	19/32	20.4	18.5	60	10.7	16,76
1211457	A7402DZ-5/8	5/8	21.1	19.0	60	15.5	16,76
1211458	A7402DZ-11/16	11/16	23.6	20.5	60	15.5	16,76
1211459	A7402DZ-3/4	3/4	25.2	22.0	60	18.5	16,76
1211460	A7402DZ-13/16	13/16	26.7	23.5	60	17.0	16,76
1211461	A7402DZ-7/8	7/8	29.1	26.0	60	18.3	16,76

8767 B HF - Llave de vaso 3/8" TORX®



Llave de vaso Zyklop 3/8" con función retención



Ref.	Código	Entrecaras mm	Largo mm	Ancho mm	Alto mm	€/ u.
8005429	05003059001	TX 10	102	44	20	13,07
8005430	05003060001	TX 15	102	44	20	13,07
8005431	05003061001	TX 20	102	44	20	13,07
8005432	05003062001	TX 25	102	44	20	13,07
8005433	05003063001	TX 25	175	44	20	16,43
8005434	05003064001	TX 27	133	44	20	13,07
8005435	05003065001	TX 27	175	44	20	16,43
8005436	05003066001	TX 30	102	44	22	13,07

Ref.	Código	Entrecaras mm	Largo mm	Ancho mm	Alto mm	€/ u.
8005437	05003067001	TX 30	175	45	23	16,43
8005438	05003068001	TX 40	102	44	22	13,07
8005439	05003069001	TX 40	175	44	20	16,43
8005440	05003070001	TX 45	106	44	20	13,07
8005441	05003071001	TX 45	170	44	20	16,43
8005442	05003072001	TX 50	106	44	20	14,14
8005443	05003073001	TX 50	167	44	20	17,61

749 - Llave CROWFOOT 3/8"



Llave Crowfoot 3/8", para racores|Según normas ISO 1174 y DIN 3120|Material: Aleación de acero de alto rendimiento|El acabado cromado brillante proporciona una superficie de gran calidad

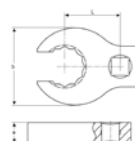

Ref.	Código	Entrecaras mm	A mm	B mm	C mm	Cuadradillo interior *	€/ u.
1271100	749-17	17	17.5	27.3	14.0	3/8	64,45
1271101	749-19	19	18.5	29.0	15.8	3/8	64,45
1271102	749-21	21	18.5	31.3	16.2	3/8	65,78
1271103	749-22	22	19.0	33.5	17.0	3/8	65,78
1271104	749-24	24	19.5	35.7	18.0	3/8	59,72
1271105	749-26	26	20.0	37.7	19.0	3/8	74,51
1271106	749-27	27	21.4	40.0	20.0	3/8	73,51



8100 SB Juego Carraca ZYKLOP 3/8", aislado



Juego de carraca Zyklop, aislado, con palanca de conmutación, con arrastre de 3/8"; métrico, 17 piezas



Ref.	Código	Contenido	Largo mm	Ancho mm	Alto mm	€ / u.
8005444	05004970001	8007 B VDE 1 x 3/8"x222.0;8790 B VDE 1 x 6.0x46.0; 1 x 7.0x46.0; 1 x 8.0x46.0; 1 x 9.0x46.0; 1 x 10.0x46.0; 1 x 11.0x46.0; 1 x 12.0x46.0; 1 x 13.0x46.0; 1 x 14.0x46.0; 1 x 15.0x46.0; 1 x 16.0x46.0; 1 x 17.0x46.0; 1 x 18.0x46.0; 1 x 19.0x46.0;8794 SB VDE 1 x 3/8"x91.0;8794 LB VDE 1 x 3/8"x166.0;	295	178	60	657,71

8790 B - Llave de vaso 3/8", aislada



Ref.	Código	Entrecaras mm	Largo mm	Ancho mm	Alto mm	€ / u.
8005447	05004950001	6.0	66	23	23	26,44
8005448	05004951001	7.0	90	50	23	26,44
8005449	05004952001	8.0	46	23	23	26,44
8005450	05004953001	9.0	46	23	23	26,44
8005451	05004954001	10.0	46	23	23	28,08
8005452	05004955001	11.0	47	23	23	28,08
8005453	05004956001	12.0	46	23	23	28,08
8005454	05004957001	13.0	46	23	23	28,08
8005455	05004958001	14.0	90	50	25	28,08
8005456	05004959001	15.0	46	26	26	29,73
8005457	05004960001	16.0	46	27	27	29,73
8005458	05004961001	17.0	46	23	23	29,73
8005459	05004962001	18.0	47	30	30	29,73
8005460	05004963001	19.0	47	31	31	29,73



8794 SB - Prolongador de llaves de vaso 3/8", aislado



Ref.	Código	Largo mm	Ancho mm	Alto mm	€ / u.
8005445	05004964001	92	23	23	42,92
8005446	05004965001	166	23	23	52,89



8000 B - Carraca Zyklop Speed 3/8"



Con la carraca Zyklop usted tendrá 5 tipos de carraca en una sola (carraca con dentado fino, carraca articulada, carraca flexible, carraca con bloqueo de vaso, carraca de potencia), e incluso puede utilizarla como si fuera un destornillador.

Ref.	Código	Descripción	Longitud mm	€ / u.
1211750	05003550001	Cabeza giratoria	199	116,06



7754 - Mango corredizo 3/8"



ISO 3315 - 1174 · DIN 3122 - 3123 - 3120 · UNE 16512. Acero cromo vanadio tratado. Cromado.

Ref.	Código	Longitud mm	€ / u.
1211800	7754	160	18,09

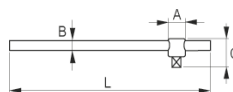

7760 - Extension 3/8"



ISO 3316 / 1174 · DIN 3122 / 3123 / 3120 · UNE 16511. Acero cromo vanadio tratado. Cromada.

Ref.	Código	Longitud mm	€/ u.
1211900	7760	75	12,84
1211901	7761	127	15,37

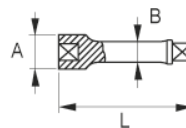

7766 - Articulación universal 3/8"



UNE 16511 · ISO 3316 - 1174 · DIN 3122 - 3123 -3120. Acero aleado especial tratado. Cromada. Mantiene la posición. Deseada, mediante freno.

Ref.	Código	Longitud mm	€/ u.
1212000	7766	51.5	29,34

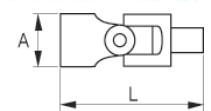

7764 - Adaptador 3/8"



UNE 16511 · ISO 1174 · DIN 3120 - 3123. Acero aleado especial tratado. Cromado.

Ref.	Código	Cuadrado interior "	Cuadrado Exterior	Longitud mm	€/ u.
1212100	7764	3/8	1/4	24.7	12,29
1212101	8164-1/2	3/8	1/2	33	12,29

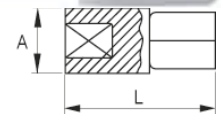

8167 - Ampliador plano 3/8"-1/2"



Ref.	Código	Cuadrado interior "	Cuadrado Exterior"	Longitud mm	€/ u.
1212200	8167	3/8	1/2	13.0	28,35



910ME Llave de vaso 3/8" punta hexagonal



Fabricado en una sola pieza

Ref.	Código	Entrecaras mm	Ø mm	L mm	L1 mm	€/ u.
8005145	9100504	4	18	62	15	17,10
8005146	9100505	5	18	62	15	17,10
8005147	9100506	6	18	62	15	17,10
8005148	9100507	7	18	62	15	17,40
8005149	9100508	8	19	62	15	17,40
8005150	9100510	10	20	62	15	17,40
8005151	9100512	12	20	62	15	17,40



7750 - Carraca reversible 3/8"



ISO 3315 - 1174-2 • DIN 3122 - 3120 • UNE 16512. Acero cromo vanadio tratado.
Rueda de 80 dientes.

Ref.	Código	Longitud mm	€ / u.
1211600	7750	205	55,34

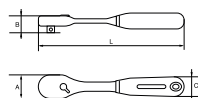

7750RN - Carraca reversible 3/8"



UNE 16512 • ISO 3315 - 1174-2 • DIN 3122 - 3120. Acero cromo vanadio tratado.
Rueda de 72 dientes.

Ref.	Código	Longitud mm	€ / u.
1211700	7750RN	202	52,45



8007 B - Carraca reversible 3/8", aislada



Carraca Zyklop, aislada, con palanca de conmutación y arrastre de 3/8"



Ref.	Código	Largo	ancho	alto	€ / u.
8004525	05004966001	290	60	35	137,60

8100 SB 6 - Juego de carraca Zyklop Speed, cuadradillo de 3/8"



Juego de 29 piezas; en caja compacta de material textil para la protección de superficies, de gran robustez. Peso y volumen reducidos facilitan la movilidad. 1 carraca Zyklop Speed con cuadradillo de 3/8", 9 vasos Zyklop, 1 prolongación Zyklop (larga) con manguito de giro rápido, 1 prolongación "Wobble", 1 adaptador porta-puntas de cambio rápido, 16 puntas

Ref.	Código	Contenido	€ / u.
1213885	05004046001	<ul style="list-style-type: none"> 8000 B 1x 3/8"x199,0 8790 HMB 1x 8,0x29,0; 1x 10,0x29,0; 1x 12,0x29,0; 1x 13,0x29,0; 1x 15,0x29,0; 1x 16,0x30,0; 1x 17,0x30,0; 1x 18,0x30,0; 1x 19,0x30,0 8794 LB 1x 3/8"x200,0 8794 B 1x 3/8"x76,0 8784 B1 1x 1/4"x3/8"x44,0 851/4 TZ PH 1x PH 1x50; 1x PH 2x50; 1x PH 3x50 855/4 TZ PZ 1x PZ 1x50; 1x PZ 2x50; 1x PZ 3x50 867/4 Z TORX® 1x TX 20x50; 1x TX 25x50; 1x TX 27x50; 1x TX 30x50; 1x TX 40x50 840/4 Z Hex-Plus 1x 4,0x50; 1x 5,0x50; 1x 6,0x50; 1x 8,0x50 800/4 Z 1x 1,0x5,5x50 	273,73

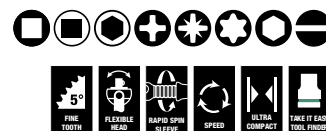

910ME/SB5 Juego de 5 llaves de vaso 3/8" punta hexagonal, con soporte



01

Fabricados en una sola pieza

Ref.	Código	Contenido mm	€/ u.
8005152	9100515	4-5-6-8-10	96,00



7800 - Llave de vaso 1/2"



UNE 16507 · ISO 2725 · DIN 3124. Acero cromo vanadio tratado. Cromada. Para trabajo manual. No trabajar a impacto.

Ref.	Código	Entrecaras mm	D1 mm	D2 mm	L mm	€/ u.
1212900	7800SM-8	8	12.9	22.0	38	6,40
1212901	7800SM-9	9	14.2	22.0	38	6,52
1212902	7800SM-10	10	15.4	22.0	38	6,52
1212903	7800SM-11	11	16.6	22.0	38	6,52
1212904	7800SM-12	12	17.9	22.0	38	6,90
1212905	7800SM-13	13	19.1	22.0	38	7,20
1212906	7800SM-14	14	20.4	22.0	38	7,58
1212907	7800SM-15	15	21.6	22.0	38	7,85
1212908	7800SM-16	16	22.9	22.0	38	8,00
1212909	7800SM-17	17	24.1	23.0	38	8,32
1212910	7800SM-18	18	25.4	23.5	38	8,32
1212911	7800SM-19	19	26.6	24.0	38	8,64
1212913	7800SM-21	21	29.1	25.0	39	9,12
1212914	7800SM-22	22	30.4	25.5	39	9,45
1212915	7800SM-23	23	31.6	26.0	40	9,93
1212916	7800SM-24	24	32.9	26.5	41	10,65
1212917	7800SM-25	25	34.1	27.0	42	10,82
1212918	7800SM-26	26	35.4	28.0	43	11,04
1212919	7800SM-27	27	36.6	29.0	44	11,34
1212920	7800SM-28	28	37.9	29.0	45	12,17
1212922	7800SM-30	30	40.4	29.5	47	12,64
1212923	7800SM-32	32	42.9	30.5	47	12,89

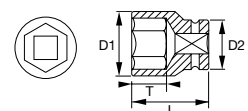

4401M - Llave de vaso 1/2"



Ref.	Código	Entrecaras mm	D1 mm	D2 mm	Longitud mm	€/ u.
1490018	8K4401M8	8	13,2	22	36	6,13
1490019	8K4401M9	9	13,8	22	37	6,13
1490110	8K4401M10	10	15,3	22	37	6,13
1490111	8K4401M11	11	16,5	22	37	6,13
1490112	8K4401M12	12	17,8	22	37	6,13
1490113	8K4401M13	13	19	22	37	6,13
1490114	8K4401M14	14	20,3	22	37	6,54
1490115	8K4401M15	15	21,5	22	37	6,54
1490116	8K4401M16	16	22,8	22	37	6,54
1490117	8K4401M17	17	24	22	37	6,54
1490118	8K4401M18	18	25	23	37	6,54
1490119	8K4401M19	19	26,5	24,5	38	6,54
1490120	8K4401M20	20	27,8	26	38	7,57
1490121	8K4401M21	21	29	27	38	7,57
1490122	8K4401M22	22	30	28	40	7,57

Ref.	Código	Entrecaras mm	D1 mm	D2 mm	Longitud mm	€/ u.
1490123	8K4401M23	23	31,5	29	40	8,13
1490124	8K4401M24	24	32,8	30	42	8,13
1490125	8K4401M25	25	34	31	42	10,14
1490126	8K4401M26	26	35	32	42	10,14
1490127	8K4401M27	27	36,5	33	43	10,14
1490128	8K4401M28	28	37,8	34	43	11,90
1490129	8K4401M29	29	39	35	43	11,90
1490130	8K4401M30	30	40	36	46	12,98
1490131	8K4401M31	31	41,5	37	46	13,16
1490132	8K4401M32	32	42,8	38	46	13,16
1490033	8K4400M33	33	44,2	39	47	19,30
1490034	8K4400M34	34	45,2	40	47	19,67
1490035	8K4400M35	35	46,2	40	47	20,98
1490036	8K4400M36	36	47,2	41	47	21,29
1490038	8K4400M38	38	49,2	43	47	27,80



8790 HMC HF - Llave de vaso Zyklop con arrastre de 1/2" con retención



Aplicación: Para tornillos y tuercas hexagonales exteriores. Realización: Para la aplicación manual y a máquina [no de impacto], con ranura para retener un pasador, con moleteado en la parte posterior para mayor adherencia en la utilización manual, con función sujeta-tornillos, de cromo-vanadio, en cromado mate, con una señalización a color y la marca del tamaño para encontrar el vaso deseado más fácilmente.



Ref.	Código	Entrecaras mm	vaso_alto_cuello mm	Longitud mm	vaso_diame-tro_base	vaso_diame-tro_cuello	€ / u.
1213035	05003730001	10,0	10,4	37,0	23,5	17,8	10,61
1213036	05003731001	11,0	10,4	37,0	23,5	18,8	10,61
1213037	05003732001	12,0	11,4	37,0	23,5	20,4	10,61
1213038	05003733001	13,0	11,4	37,0	23,5	21,4	10,74
1213039	05003734001	14,0	11,4	37,0	23,5	22,6	11,75
1213040	05003735001	15,0	12,0	37,0	23,5	23,6	11,75
1213041	05003736001	16,0	12,0	37,0	23,5	25,0	11,88
1213042	05003737001	17,0	12,5	37,0	23,5	26,8	12,63
1213043	05003738001	18,0	12,5	37,0	23,5	28,0	14,03
1213044	05003739001	19,0	14,0	37,0	23,5	29,2	14,03



7800 - Llave de vaso 1/2", bihexagonal



Ref.	Código	Entrecaras mm	D1 mm	D2 mm	L mm	€ / u.
1213000	7800DM-8	8	12,9	22,0	38	6,40
1213001	7800DM-9	9	14,2	22,0	38	6,40
1213002	7800DM-10	10	15,4	22,0	38	6,40
1213003	7800DM-11	11	16,6	22,0	38	6,52
1213004	7800DM-12	12	17,9	22,0	38	6,90
1213005	7800DM-13	13	19,1	22,0	38	7,20
1213006	7800DM-14	14	20,4	22,0	38	7,58
1213007	7800DM-15	15	21,6	22,0	38	7,85
1213008	7800DM-16	16	22,9	22,0	38	8,00
1213009	7800DM-17	17	24,1	23,0	38	8,32
1213010	7800DM-18	18	25,4	23,5	38	8,32
1213011	7800DM-19	19	26,6	24,0	38	8,64
1213012	7800DM-20	20	27,9	24,5	38	8,88
1213013	7800DM-21	21	29,1	25,0	39	9,12
1213014	7800DM-22	22	30,4	25,5	39	9,45
1213015	7800DM-23	23	31,6	26,0	40	9,93
1213016	7800DM-24	24	32,9	26,5	41	10,65
1213017	7800DM-25	25	34,1	27,0	42	10,82
1213018	7800DM-26	26	35,4	28,0	43	11,04
1213019	7800DM-27	27	36,6	29,0	44	11,34
1213020	7800DM-28	28	37,9	27,6	45	12,17
1213021	7800DM-29	29	39,1	28,6	46	12,49
1213022	7800DM-30	30	40,4	29,5	47	12,64
1213023	7800DM-32	32	42,9	30,5	47	13,14



920INOX-A Llave de vaso 1/2", acero inoxidable



- Alta resistencia a la corrosión • Evita la oxidación incorrecta • Características mecánicas sobresalientes
- Acero inoxidable AISI 420

Ref.	Código	Entrecaras mm	Ø mm	A mm	L mm	Ø1 mm	€ / u.
8005164	9203008	8	15	10	40	24	33,50
8005165	9203009	9	16	10	40	24	36,00
8005166	9203010	10	17	10	40	24	37,50
8005167	9203011	11	18	11	40	24	39,00
8005168	9203012	12	19	11	40	24	42,00
8005169	9203013	13	20	11	40	24	44,50
8005170	9203014	14	21	11	40	24	46,50
8005171	9203015	15	23	11	40	25	49,00
8005172	9203016	16	24	11	40	25	51,00
8005173	9203017	17	25	11	40	25	53,00
8005174	9203018	18	26	13	42	25	55,00
8005175	9203019	19	28	13	42	25	57,00
8005176	9203020	20	29	13	42	26	60,50
8005177	9203021	21	30	13	43	26	61,50
8005178	9203022	22	31	15	43	26	62,00
8005179	9203024	24	34	15	43	28	72,00
8005180	9203027	27	38	18	46	30	89,00
8005181	9203030	30	42	20	46	30	108,50
8005182	9203032	32	44	20	46	34	118,00



SS220-Llave de vaso de 1/2", acero inoxidable



Vaso de acero inoxidable con cuadradillo de 1/2" y perfil hexagonal

Ref.	Código	Entrecaras mm	€/ u.
2400318	SS220-8	8	33,01
2400319	SS220-9	9	34,29
2400320	SS220-10	10	35,59
2400321	SS220-11	11	37,53
2400322	SS220-12	12	40,12
2400323	SS220-13	13	41,41
2400324	SS220-14	14	43,36
2400325	SS220-15	15	46,59
2400326	SS220-16	16	48,54
2400327	SS220-17	17	50,47
2400328	SS220-18	18	53,06
2400329	SS220-19	19	55,65
2400330	SS220-20	20	58,24
2400331	SS220-21	21	59,54
2400332	SS220-22	22	60,82
2400333	SS220-23	23	66,00
2400334	SS220-24	24	69,89
2400335	SS220-25	25	73,77
2400336	SS220-26	26	84,12
2400337	SS220-27	27	86,71
2400338	SS220-28	28	93,18
2400339	SS220-29	29	97,06
2400340	SS220-30	30	102,25
2400341	SS220-31	31	112,59
2400342	SS220-32	32	112,59



7805SM - Llave de vaso 1/2", serie larga



ISO 2725-1 - 1174-1 - DIN 3120. Acero aleado especial, tratado. Cromada. Boca hexagonal.

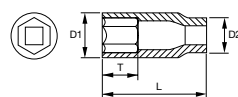

Ref.	Código	Entrecaras mm	D1 mm	D2 mm	L mm	€/ u.
1271300	7805SM-10	10	14.9	22.5	82.6	17,47
1271301	7805SM-12	12	17.9	22.5	82.6	17,47
1271302	7805SM-13	13	17.9	22.5	82.6	17,47
1271303	7805SM-14	14	20.4	22.5	82.6	18,20
1271304	7805SM-15	15	21.6	22.5	82.6	19,16
1271305	7805SM-16	16	22.9	22.5	82.6	19,66
1271306	7805SM-17	17	24.1	22.5	82.6	19,66
1271307	7805SM-18	18	25.2	22.5	82.6	19,66
1271308	7805SM-19	19	26.3	22.5	82.6	19,66

Ref.	Código	Entrecaras mm	D1 mm	D2 mm	L mm	€/ u.
1271310	7805SM-21	21	28.3	24.3	82.6	21,91
1271311	7805SM-22	22	29.9	25.9	82.6	22,08
1271312	7805SM-23	23	28.3	24.3	82.6	22,78
1271313	7805SM-24	24	32.0	28.0	82.6	22,78
1271315	7805SM-26	26	34.7	30.7	82.6	25,24
1271316	7805SM-27	27	36.2	32.2	82.6	25,24
1271319	7805SM-30	30	40.9	36.4	82.6	26,99
1271320	7805SM-32	32	40.9	36.4	82.6	29,20

7805DM - Llave de vaso 1/2" bihexagonal, serie larga



ISO 2725-1 - 1174-1 - DIN 3120. Acero aleado especial tratado. Cromadas. Boca bihexagonal.

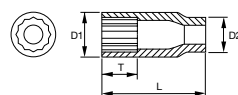

Ref.	Código	Entrecaras mm	D1 mm	D2 mm	L mm	€/ u.
1213200	7805DM-10	10	14.9	22.5	82.6	17,14
1213202	7805DM-12	12	17.9	22.5	82.6	17,14
1213203	7805DM-13	13	17.9	22.5	82.6	17,14
1213204	7805DM-14	14	20.4	22.5	82.6	17,92
1213205	7805DM-15	15	21.6	22.5	82.6	18,83
1213206	7805DM-16	16	22.9	22.5	82.6	19,37
1213207	7805DM-17	17	24.1	22.5	82.6	19,37

Ref.	Código	Entrecaras mm	D1 mm	D2 mm	L mm	€/ u.
1213208	7805DM-18	18	25.2	22.5	82.6	19,37
1213209	7805DM-19	19	26.3	22.5	82.6	19,37
1213210	7805DM-21	21	28.3	24.3	82.6	21,52
1213211	7805DM-22	22	29.9	25.9	82.6	21,73
1213212	7805DM-24	24	32.0	28.0	82.6	22,38
1213213	7805DM-27	27	36.2	32.2	82.6	24,80
1213214	7805DM-30	30	40.9	36.4	82.6	26,52

7800TORX E - Llave de vaso 1/2" TORX®



ISO 2725 - 1174 • DIN 3124 - 3120. Acero aleado especial, tratado. Cromadas.
Boca torx®.

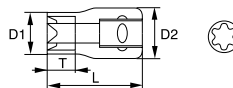

Ref.	Código	Punta torx	D1 mm	D2 mm	L mm	Para tornillo Métrica	€ / u.	Ref.	Código	Punta torx	D1 mm	D2 mm	L mm	Para tornillo Métrica	€ / u.
1213302	7800TORX-E12	E-12	22	22	38	M8+M10	10,40	1213305	7800TORX-E18	E-18	22	22	38	M12+M14	10,56
1213303	7800TORX-E14	E-14	22	22	38	M10+M12	10,40	1213306	7800TORX-E20	E-20	22	22	38	M14+M16	11,13
1213304	7800TORX-E16	E-16	22	22	38	-	10,56	1213307	7800TORX-E24	E-24	22	22	38	M18+M2	12,23

789 - Llave CROWFOT 1/2"



Llave Crowfoot 1/2", para racores|Según normas ISO 1174 y DIN 3120|Material: Aleación de acero de alto rendimiento|El acabado cromado brillante proporciona una superficie de gran calidad

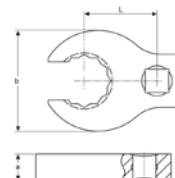

Ref.	Código	Entrecaras mm	A mm	B mm	C mm	€ / u.
1271400	789-30	30	22.5	48.0	22.0	80,13
1271401	789-32	32	22.5	48.0	24.0	84,14
1271402	789-36	36	24.0	52.0	27.0	90,84
1271403	789-41	41	24.5	58.0	31.0	111,02
1271404	789-46	46	26.0	64.2	34.0	123,58

NS220-Llave de vaso de 1/2", antichispa



Vaso de 1/2" anti-chispa, de aluminio bronce y con perfil hexagonal

Ref.	Código	Entrecaras mm	€ / u.
2400343	NS220-17	17	85,53
2400344	NS220-18	18	87,10
2400345	NS220-19	19	88,69
2400346	NS220-20	20	90,28
2400347	NS220-21	21	95,04
2400348	NS220-22	22	98,20
2400349	NS220-23	23	101,37
2400350	NS220-24	24	107,69
2400351	NS220-25	25	110,87
2400352	NS220-26	26	118,79
2400353	NS220-27	27	123,55
2400354	NS220-28	28	126,71
2400355	NS220-29	29	138,24
2400356	NS220-30	30	139,38
2400357	NS220-32	32	142,55
2400358	NS220-34	34	123,41
2400359	NS220-36	36	135,75
2400360	NS220-41	41	164,99

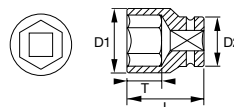

7800DMV - Llave de vaso 1/2", bihexagonal, aislada

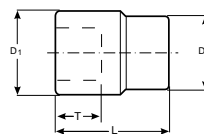

Ref.	Código	Entrecaras mm	D1 mm	D2 mm	L mm	€ / u.
1244700	7800DMV-8	8	17	22	50	23,98
1244701	7800DMV-10	10	19.5	22	50	24,68
1244702	7800DMV-11	11	20.5	22	50	24,68
1244703	7800DMV-12	12	22	22	50	24,68
1244704	7800DMV-13	13	23.2	22	50	24,68
1244705	7800DMV-14	14	24.5	22	50	24,54
1244706	7800DMV-15	15	25.5	23	50	24,54
1244707	7800DMV-16	16	27	23	50	25,23
1244708	7800DMV-17	17	28.2	24	50	25,39

Ref.	Código	Entrecaras mm	D1 mm	D2 mm	L mm	€ / u.
1244709	7800DMV-18	18	29.5	25	50	25,00
1244710	7800DMV-19	19	30.5	27	50	25,72
1244711	7800DMV-20	20	32	28	50	26,10
1244712	7800DMV-21	21	33.2	29	50	25,71
1244713	7800DMV-22	22	34.5	30	52	25,87
1244714	7800DMV-24	24	37	33	52	27,24
1244715	7800DMV-27	27	40.5	37	54	28,08
1244716	7800DMV-30	30	44.5	40	56	30,58
1244717	7800DMV-32	32	47	43	58	31,73

8152 - Berbiquí 1/2"



ISO 3315 - 1174 - DIN 3122 - 3123 - 3120. Acero cromo vanadio, tratado. Cromado. Mango giratorio.

Ref.	Código	Longitud mm	€ / u.
1214300	8152-1/2	417	47,45

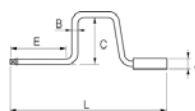

8160-1/2V - Alargadera 1/2", aislada



ISO 3316/1174-2, IEC 60900, certificado VDE.

Ref.	Código	L mm	€ / u.
1244600	8160-1/2V	125	46,61
1244601	8162-1/2V	250	49,91

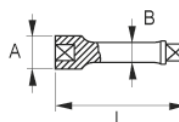

8967/S - Juego tres adaptadores



Ref.	Código	Contenido	€ / u.
1214400	8967/S3	7767-8167-8967	85,14



7809M - Vaso destornillador 1/2" punta hexagonal



ISO 1174 · DIN 3120. Puntas, hexágono de 10 mm. Bocas hexagonales. Vaso cromado, punta pavonada.

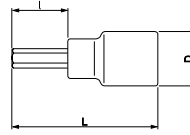

Ref.	Código	Entrecaras mm	d mm	L mm	l mm	€/ u.
1214601	7809M-5	5	22	60	23	12,98
1214602	7809M-6	6	22	60	23	12,98
1214603	7809M-7	7	22	60	23	12,98
1214604	7809M-8	8	22	60	23	14,08
1214610	7809M-9	9	22	60	23	14,08

Ref.	Código	Entrecaras mm	d mm	L mm	l mm	€/ u.
1214605	7809M-10	10	22	60	23	14,08
1214606	7809M-12	12	22	60	23	14,39
1214607	7809M-14	14	23	60	20	14,42
1214611	7809M-17	17	27	60	20	15,13
1214612	7809M-19	19	30	60	20	15,55

920ME Vaso destornillador 1/2" punta hexagonal



Fabricado en una sola pieza



Ref.	Código	Entrecaras mm	Ø mm	L mm	L1 mm	€/ u.
8005154	9200505	5	21	75	15,5	17,40
8005155	9200506	6	21	75	15,5	17,40
8005156	9200507	7	21	75	15,5	17,40
8005157	9200508	8	21	75	15,5	17,40

Ref.	Código	Entrecaras mm	Ø mm	L mm	L1 mm	€/ u.
8005158	9200510	10	23	75	15,5	17,80
8005159	9200512	12	24	75	15,5	20,30
8005160	9200514	14	24	75	15,5	20,50
8005161	9200517	17	24	75	15,5	20,50

7809M - Vaso destornillador 1/2" con punta hexagonal larga



ISO 1174 · DIN 3120. Puntas, hexágono de 10 mm. Bocas hexagonales. Vaso cromado, punta pavonada.

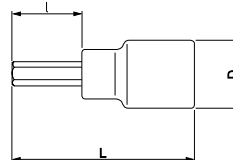

Ref.	Código	d mm	Hexágono exterior mm	L mm	l mm	€/ u.
1214700	7809M-5-180	22	5	60	23	21,46
1214702	7809M-7-100	22	7	60	23	17,07

Ref.	Código	d mm	Hexágono exterior mm	L mm	l mm	€/ u.
1214703	7809M-8-120	22	8	60	23	19,64

8740 C HF - Zyklop vaso con punta hex arrastre de 1/2" y función de retención



01

Aplicación: Para tornillos de hexagonal interior. Realización: Para la aplicación manual y a máquina (no de impacto), con ranura para retener un pasador, con moleteado en la parte posterior para mayor adherencia en la utilización manual, de cromo-vanadio, en cromado mate, con función de retención para tornillos de hexagonal interior, con una señalización a color para encontrar el vaso de punta deseado más fácilmente

Ref.	Código	Entrecaras mm	vaso_alto_cuello mm	Longitud mm	vaso_diámetro_base mm	vaso_diámetro_cuello mm	€/ u.
1213070	05003820001	4,0	21,5	60,0	21,5	14,0	15,51
1213071	05003840001	4,0	101,5	140,0	21,5	14,0	19,43
1213072	05003821001	5,0	21,5	60,0	21,5	14,0	15,51
1213073	05003841001	5,0	101,5	140,0	21,5	14,0	19,43
1213074	05003822001	6,0	21,5	60,0	21,5	14,0	15,51
1213075	05003842001	6,0	101,5	140,0	21,5	14,0	19,43
1213076	05003823001	7,0	21,5	60,0	23,5	14,0	16,16
1213077	05003843001	7,0	101,5	140,0	23,5	14,0	20,19
1213078	05003824001	8,0	21,5	60,0	23,5	16,0	16,16
1213079	05003844001	8,0	101,5	140,0	23,5	16,0	20,19
1213080	05003825001	10,0	21,5	60,0	23,5	16,0	17,04
1213081	05003845001	10,0	101,5	140,0	23,5	16,0	21,33
1213082	05003826001	12,0	23,0	60,0	23,5	21,0	18,05
1213083	05003827001	14,0	23,0	60,0	23,5	22,0	19,20
1213084	05003828001	17,0	23,0	60,0	25,5	24,5	23,99
1213085	05003829001	19,0	23,0	60,0	27,5	26,5	26,88



7809Z - Vaso destornillador 1/2" con punta hexagonal, pulgadas



ISO 1174 • DIN 3120. Puntas, hexágono de 10 mm. Bocas hexagonales. Vaso cromado, punta pavonada.

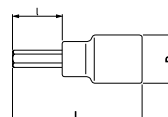

Ref.	Código	Hexágono exterior"	d mm	L mm	l mm	€/ u.
1271500	7809Z-3/16	3/16	22	60	22	12,75
1271501	7809Z-1/4	1/4	22	60	22	12,75
1271502	7809Z-5/16	5/16	22	60	22	12,75
1271503	7809Z-3/8	3/8	22	60	22	12,75
1271504	7809Z-7/16	7/16	22	60	22	13,11

Ref.	Código	Hexágono exterior"	d mm	L mm	l mm	€/ u.
1271505	7809Z-1/2	1/2	22	60	22	13,84
1271506	7809Z-9/16	9/16	23	60	23	14,20
1271507	7809Z-19/32	19/32	23	60	23	14,56
1271508	7809Z-5/8	5/8	27	61	27	14,56

7809-TORX - Vaso destornillador 1/2" con punta TORX®



ISO 1174 • DIN 3120. Puntas, hexágono de 10 mm. Bocas torx®. Vaso cromado, punta pavonada.

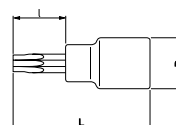

Ref.	Código	Punta torx	d mm	L mm	Para tornillo Métrica	€/ u.
1214800	7809TORX-T20	T20	22	60	M 4	14,73
1214801	7809TORX-T25	T25	22	60	M 5	14,73
1214802	7809TORX-T27	T27	22	60	-	14,73
1214803	7809TORX-T30	T30	22	60	M 6	14,73
1214804	7809TORX-T40	T40	22	60	M 8	17,19

Ref.	Código	Punta torx	d mm	L mm	Para tornillo Métrica	€/ u.
1214805	7809TORX-T45	T45	22	60	-	17,19
1214806	7809TORX-T50	T50	22	60	M 10	17,19
1214807	7809TORX-T55	T55	22	60	M 12	21,52
1214808	7809TORX-T60	T60	22	60	M 14	21,52





8767 C HF - Zyklop vaso con punta TORX® arrastre de 1/2" con retención

Aplicación: Para tornillos de TORX® interior. Realización: Para la aplicación manual y a máquina (no de impacto), con ranura para retener un pasador, con moleteado en la parte posterior para mayor adherencia en la utilización manual, de cromo-vanadio, en cromado mate, con función de retención para tornillos TORX® según especificación de Acument Intellectual Properties, con una señalización a color.

Ref.	Código	Punta torx	vaso_alto_cuello	Longitud mm	vaso_diametro_base	vaso_diametro_cuello	€/ u.
1213050	05003830001	TX 20	21,5	60,0	23,5	16,4	15,26
1213051	05003850001	TX 20	101,5	140,0	23,5	16,4	19,00
1213052	05003831001	TX 25	21,5	60,0	23,5	16,4	15,26
1213053	05003851001	TX 25	101,5	140,0	23,5	16,4	19,00
1213054	05003832001	TX 27	21,5	60,0	23,5	16,4	15,26
1213055	05003852001	TX 27	101,5	140,0	23,5	16,4	19,00
1213056	05003833001	TX 30	21,5	60,0	23,5	16,4	15,26
1213057	05003853001	TX 30	101,5	140,0	23,5	16,4	19,00
1213058	05003834001	TX 40	21,5	60,0	23,5	16,4	15,26
1213059	05003854001	TX 40	101,5	140,0	23,5	16,4	19,00
1213060	05003835001	TX 45	21,5	60,0	23,5	16,4	15,26
1213061	05003855001	TX 45	101,5	140,0	23,5	16,4	19,00
1213062	05003836001	TX 50	21,5	60,0	23,5	21,4	16,37
1213063	05003856001	TX 50	101,5	140,0	23,5	21,4	20,26
1213064	05003837001	TX 55	21,5	60,0	23,5	21,4	16,37
1213065	05003857001	TX 55	101,5	140,0	23,5	21,4	20,26
1213066	05003838001	TX 60	21,5	60,0	23,5	21,4	16,37
1213067	05003858001	TX 60	101,5	140,0	23,5	21,4	20,26



8797 C - Barra de prolongación Zyklop Hybrid



Aplicación: Se utiliza como prolongación del Wera Zyklop Hybrid 8006 C para aumentar el par de apriete que se ha de transmitir. Realización: Acero templado de cromo-molibdeno. Mango: Multicomponente tipo "Kraftform" para una resistencia óptima de presión y tracción; con perno de desbloqueo.



Ref.	Código	barra_alto_mm	Longitud mango	€/ u.
1213870	05003781001	134,0	137	43,24

8150 - Carraca reversible 1/2"



ISO 3315 - 1174-2 · DIN 3122 - 3120 · UNE 16512. Acero cromo vanadio tratado. Rueda de 80 dientes.

Ref.	Código	Longitud mm	€/ u.
1213500	8150-1/2	270	64,90

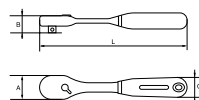

8150RN - Carraca reversible 1/2"



ISO 3315 / 1174-2 · DIN 3122 / 3120 · UNE 16512. Acero cromo vanadio tratado. Rueda de 72 dientes.

Ref.	Código	Longitud mm	€/ u.
1213800	8150RN-1/2	270	62,68



Carraca 8006 C - Hybrid Metal, arrastre de 1/2" y con palanca de inversión de giro



Aplicación: Para llaves de vaso de 1/2" y adaptadores de 1/2", con bloqueo de bola. Realización: Los 72 dientes finos permiten un ángulo de reenvío de tan sólo 5°; un cambio de sentido cómodo por medio de la palanca de inversión; un bloqueo de vasos seguro Mango: Multicomponente tipo "Kraftform" para una resistencia óptima de presión y tracción; en la base del mango, dispositivo.



Ref.	Código	carraca_alto_mm	carraca_ancho_cabeza	carraca_grosor_cabeza	Cuadradillo interior"	€ / u.
1213860	05003780001	281	37	34	1/2	103,52

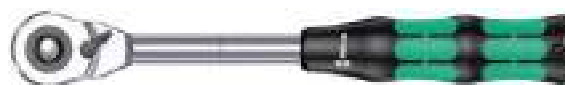

8150-1/2V - Llave de carraca 1/2", aislada



Ref.	Código	A mm	B mm	d mm	Longitud mm	€ / u.
1244500	8150-1/2V	77	50	12.5	270	195,16

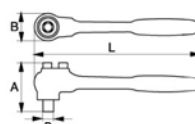

SS-242- Carraca reversible 1/2", de acero inoxidable



Carraca reversible de acero inoxidable de 1/2"

Ref.	Código	Longitud mm	€ / u.
2400361	SS242-16-245	245	155,

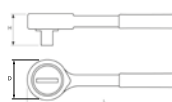

8000 C - Carraca Zyklop Speed 1/2"



Con la carraca Zyklop usted tendrá 5 tipos de carraca en una sola (carraca con dentado fino, carraca articulada, carraca flexible, carraca con bloqueo de vaso, carraca de potencia), e incluso puede utilizarla como si fuera un destornillador.

Ref.	Código	Descripción	Longitud mm	€ / u.
1213850	05003600001	Cabeza giratoria	277	127,79



920/55INOX Carraca reversible 1/2", de acero inoxidable



• Alta resistencia a la corrosión • Evita la oxidación incorrecta • Características mecánicas sobresalientes • Acero inoxidable AISI 420 • 100% de acero inoxidable • 72 dientes

Ref.	Código	L mm	Ø mm	A mm	Cuadradillo "	€ / u.
8005183	9203882	264	40	43	1/2	256,00



8740 C HF 1 - Zyklop Juego de vasos con punta hexagonal, con función de retención



Juego de 9 piezas; en caja compacta de material textil para la protección de superficies, de gran robustez. Peso y volumen reducidos facilitan la movilidad. 9 Zyklop vasos de punta para tornillos de hexagonal interior, con arrastre de 1/2", con función de retención



Ref.	Código	Hexágono mm	€/ u.
1213095	05004201001	8740 C HF 1 x 4,0x60,0; 1 x 5,0x60,0; 1 x 6,0x60,0; 1 x 7,0x60,0; 1 x 8,0x60,0; 1 x 10,0x60,0; 1 x 12,0x60,0; 1 x 14,0x60,0; 1 x 17,0x60,0	166,88

54 - Juego de llaves de vaso 1/2" con punta hexagonal



Ref.	Código	Composición	Contenido piezas	€/ u.
1200280	96031508	4; 5; 6; 7; 8; 10; 12; 14; 17; 19 mm	10	201,90



920ME/C7 Juego de 7 vasos 1/2" punta hexagonal, en caja



Fabricados en una sola pieza

Ref.	Código	Contenido mm	€/ u.
8005162	9200518	5-6-8-10-12-14-17	161,50



Juego de llaves de vaso 1/2"



S240



S400



S910



S87+7

Ref.	Código	Contenido	Piezas	€ / u.
1215700	S240	18 pzs de 1/2" Vasos hexagonales con Perfil Dynamic Drive (10 11 12 13 14 15 16 17 18 19 20 21 22 23 24 27 30 32 mm) 2 pzs de 1/2" Barras de extensión de 5" y 10" 1 pz de 1/2" Junta universal cardan 1 pz de 1/2" Adaptador en T 1 pz de 1/2" Mango articulado de 10" 1 pz de 1/2" Llave de carraca de 54 dientes	24	123,95
1215701	S400	21 pzs de 1/2" Vasos hexagonales con Perfil Dynamic Drive (10 11 12 13 14 15 16 17 18 19 20 21 22 23 24 25 26 27 28 30 32 mm) 2 pzs de 1/2" Barras de extensión de 5" y 10" 1 pz de 1/2" Junta universal cardan 1 pz de 1/2" Adaptador en T 1 pz de 1/2" Mango articulado de 10" 1 pz de 1/2" Llave de carraca de 54 dientes 13 pzs Llaves mixtas acodadas (7 8 9 10 11 12 13 14 15 16 17 18 19 mm)	40	183,64
1215702	S910	12 pzs de 1/4" Vasos hexagonales con Perfil Dynamic Drive (4 4,5 5 5,5 6 7 8 9 10 11 12 13 mm) 10 pzs de 1/4" Vasos hexagonales serie larga, con Perfil Dynamic Drive (4 5 6 7 8 9 10 11 12 13 mm) 13 pzs de 1/2" Vasos hexagonales con Perfil Dynamic Drive (10 11 12 13 14 15 17 19 22 24 27 30 32 mm) 2 pzs de 1/4" Barras de extensión de 2" y 4" 1 pz de 1/4" Mango en T 1 pz de 1/4" Junta universal cardan 1 pz de 1/4" Adaptador portapuntas 1 pz de 1/4" Adaptador 1 pz de 1/4" Extensión con mango 1 pz de 1/4" Adaptador magnético 4 pzs de 1/4" Puntas para tornillos Phillips® PH 0 1 2 3 3 pzs de 1/4" Puntas para tornillos ranurados (4 5,5 7 mm) 3 pzs de 1/4" Puntas para tornillos Pozidriv® (PZ 1 2 3) 6 pzs de 1/4" Puntas para tornillos hexagonales (3 4 5 6 8 10 mm) 8 pzs de 1/4" Puntas para tornillos Torx® (T 8 10 15 20 25 27 30 40) 3 pzs de 5/16" Puntas para tornillos Torx® (T 45 50 55) 2 pzs de 1/2" Barras de extensión de 5" y 10" 1 pz de 1/2" Junta universal cardan 1 pz de 1/2" Vaso hexagonal con boca para bujías de 21 mm (13/16") 1 pz de 1/2" x 5/16" Adaptador portapuntas 1 pz de 1/2" Adaptador en T 3 pzs Llaves hexagonales (1,5 2 2,5 mm) 1 pz de 1/4" Llave de carraca de 45 dientes 1 pz de 1/2" Llave de carraca de 54 dientes 4 pzs Llaves articuladas dobles (8-9 10-11 12-13 14-15 mm) 6 pzs Llaves mixtas acodadas (8 10 12 13 14 17 mm)	92	218,36
1215703	S87+7	12 pzs de 1/4" Vasos hexagonales con Perfil Dynamic Drive 4 4,5 5 5,5 6 7 8 9 10 11 12 13 mm 9 pzs de 1/4" Vasos hexagonales serie larga, con Perfil Dynamic Drive 4 5 6 7 8 9 10 11 13 mm 15 pzs de 1/2" Vasos hexagonales con Perfil Dynamic Drive 10 12 13 14 15 16 17 18 20 21 23 24 27 32 34 mm 9 pzs de 1/2" Vasos hexagonales con Perfil Dynamic Drive AF (3/8 7/16, (11) 1/2 9/16 11/16 3/4, (19) 13/16 7/8, (22) 1-3/16") 4 pzs de 1/2" Vasos hexagonales de impacto (17 19 21 24 mm) 4 pzs de 1/4" Vasos para tornillos Phillips® (PH 1 2 3 4) 3 pzs de 1/4" Vasos para tornillos ranurados (4 5,5 7 mm) 6 pzs de 1/4" Vasos para tornillos hexagonales (3 4 5 6 8 10 mm) 2 pzs de 1/4" Barras de extensión de 2" y 4" 1 pz de 1/4" Mango en T 1 pz de 1/4" Junta universal cardan 1 pz de 1/4" Extensión con mango 2 pzs de 1/2" Barras de extensión de 5" y 10" 1 pz de 1/2" Junta universal cardan 1 pz de 1/2" Vaso hexagonal con boca para bujías de 21 mm (13/16") 1 pz de 1/2" Adaptador en T 3 pzs Llaves hexagonales 1,5 2 2,5 mm 1 pz de 1/4" Llave de carraca de 45 dientes 1 pz de 1/2" Llave de carraca de 54 dientes 4 pzs Llaves articuladas dobles (8-9 10-11 12-13 14-15 mm) 13 pzs Llaves mixtas acodadas (7 8 9 10 11 12 13 14 15 16 17 18 19 mm)	94	262,65





Juego de llaves de vaso 1/2"



S106



S108



S560



S410

Ref.	Código	Contenido	Piezas	€ / u.
1215704	S106	12 pzs de 1/4" Vasos hexagonales con Perfil Dynamic Drive (4 4,5 5 5,5 6 7 8 9 10 11 12 13 mm) 10 pzs de 1/4" Vasos hexagonales serie larga, con Perfil Dynamic Drive (4 5 6 7 8 9 10 11 12 13 mm) 15 pzs de 1/2" Vasos hexagonales con Perfil Dynamic Drive (10 12 13 14 15 16 17 18 20 21 23 24 27 32 34 mm) 9 pzs de 1/2" Vasos hexagonales con Perfil Dynamic Drive AF (3/8 7/16, (11) 1/2 9/16 11/16 3/4, (19) 13/16 7/8, (22) 1-3/16") 4 pzs de 1/2" Vasos hexagonales de impacto (17 19 21 24 mm) 4 pzs de 1/4" Vasos para tornillos Phillips® (PH 1 2 3 4) 3 pzs de 1/4" Vasos para tornillos ranurados (4 5,5 7 mm) 6 pzs de 1/4" Vasos para tornillos hexagonales (3 4 5 6 8 10 mm) 3 pzs de 1/4" Vasos para tornillos Pozidriv® PZ (1 2 3) 8 pzs de 1/4" Vasos para tornillos Torx® (T 8 10 15 20 25 27 30 40) 2 pzs de 1/4" Barras de extensión de 2" y 4" 1 pz de 1/4" Mango en T 1 pz de 1/4" Junta universal cardan 1 pz de 1/4" Extensión con mango 2 pzs de 1/2" Barras de extensión de 5" y 10" 1 pz de 1/2" Junta universal cardan 1 pz de 1/2" Vaso hexagonal con boca para bujías de 21 mm (13/16") 1 pz de 1/2" Adaptador en T 3 pzs Llaves hexagonales (1,5 2 2,5 mm) 1 pz de 1/4" Llave de carraca de 45 dientes 1 pz de 1/2" Llave de carraca de 54 dientes 4 pzs Llaves articuladas dobles (8-9 10-11 12-13 14-15 mm) 13 pzs Llaves mixtas acodadas (7 8 9 10 11 12 13 14 15 16 17 18 19 mm)	106	305,91
1215705	S108	12 pzs de 1/4"-6-pt. Vasos con perfil Dynamic Drive (4, 4.5, 5, 5.5, 6, 7, 8, 9, 10, 11, 12, 13 mm) 10 pzs de 1/4"-6-pt. Vasos serie larga con perfil Dynamic Drive (4, 5, 6, 7, 8, 9, 10, 11, 12, 13 mm) 20 pzs de 1/2" 6 pt. Vasos con perfil Dynamic drive (8, 9, 10, 11, 12, 13, 14, 15, 16, 17, 18, 19, 20, 21, 22, 23, 24, 27, 30, 32 mm) 6 pzs punta Torx (E12, E14, E16, E18, E20, E24) 4 pzs 1/2" 6-pt Vasos hexagonales de impacto con (17, 19, 21, 24 mm) 3 pzs punta ranurada (4, 5, 5, 7 mm) 4 pzs punta Phillips® (PH 1; 2; 3; 4) 3 pzs punta Pozidriv® (1; 2; 3) 6 pzs punta hexagonal 3; 4; 5; 6; 8; 10 mm 8 pzs punta Torx® 8, 10 15, 20, 25, 27, 30, 40 Accesorios de 1/4": 2 pzs Alargaderas 50 mm / 2" y 100 mm / 4"; 1 pieza: Mango corredizo 100 mm / 4"; 1 pieza: articulación Universal - 1 pieza: 1/4" Alargadera con mango. 1 pz 1/4" Llave de carraca de 60 dientes Accesorios de 1/2": 2 pzs Alargaderas 125 mm / 5" y 250 mm / 10"; 1/2" Articulación Universal. 1 pz 6-pt Vaso hexagonal para bujías 21 mm (13/16"); Adaptador para mango corredizo; 3 pzs Llaves L hexagonales (1,5, 2, 2,5 mm) 1 pz 1/2" Llave de carraca de 60 dientes con botón de ajuste rápido. 4 pzs Llaves articuladas (8-9, 10-11, 12-13, 14-15 mm) 13 pzs Llaves combinadas (7, 8, 9, 10, 11, 12, 13, 14, 15, 16, 17, 18, 19 m) 12 Vasos de 1/4" Perfil profesional 12Pt: (4, 4.5, 5, 5.5, 6, 7, 8, 9, 10, 11, 12, 13 mm) 10 Vasos largos de 1/4" Perfil profesional 12Pt: (4, 5, 6, 7, 8, 9, 10, 11, 12, 13 mm) 13 Vasos de 1/2" Perfil profesional 12 Pt: (10, 11, 12, 13, 14, 15, 17, 19, 22, 24, 27, 30, 32 mm) 3 Puntas de 5/16" Torx (45, 50, 55) 2 Alargaderas de 1/4" 50 mm/2" y 100 mm/4" 1 Mango corredizo 1/4" - 100 mm/ 4" 1 Articulación universal de 1/4" 1 Destornillador portavasos de 1/4" 1 Adaptador magnético de 1/4" 1 Portapuntas de 1/4" x 1/4" 1 Adaptador para puntas de 1/4" 2 Alargaderas de 1/2" de 125 mm/5" y 250 mm/10" 1 Adaptador para mango en "T" de 1/2" 1 Articulación universal de 1/2" 1 Portapuntas de 1/2", 5/16" 1 Vaso para bujías de 1/2", 6Pt 21 mm (13/16") 3 Llaves hexagonales de 1.5, 2, 2.5 mm 1 Carraca de 1/4" - 72 dientes, 1 Carraca de 1/2" - 72 dientes	108	306,94
1215706	S560	10 pzs Vasos de 1/4" . 6-pt de Perfil Dynamic-DriveTM (5, 5.5, 6, 7, 8, 9, 10, 11, 12, 13 mm) 2 pzs Alargadera de 1/4" 50, 150 mm 1 pz 14" Mango corredizo en T 1 pz Articulación universal de 1/4". 1 pz Carraca de 1/4". 60 dientes 10 pzs 1/2" 6-pt Vasos Perfil Dynamic-DriveTM (10, 12, 13, 14, 15, 16, 17, 19, 21, 24 mm) 2 pzs 1/2" Alargadera 125, 250 mm 1 pz 1/2" Articulación universal de 1/2". 1 pz Carraca de 1/4". 60 dientes 12 pzs Llaves combinadas (8, 9, 10, 11, 12, 13, 14, 15, 16, 17, 18, 19 mm) en una práctico estuche desmontable.	56	118,45
1215707	S410	10 pzs Vasos de 1/4" . 6-pt de Perfil Dynamic-DriveTM (5, 5.5, 6, 7, 8, 9, 10, 11, 12, 13 mm) 2 pzs Alargadera de 1/4" 50, 150 mm 1 pz 14" Mango corredizo en T 1 pz Articulación universal de 1/4". 1 pz Carraca de 1/4". 60 dientes 10 pzs 1/2" 6-pt Vasos Perfil Dynamic-DriveTM (10, 12, 13, 14, 15, 16, 17, 19, 21, 24 mm) 2 pzs 1/2" Alargadera 125, 250 mm 1 pz 1/2" Articulación universal de 1/2". 1 pz Carraca de 1/4". 60 dientes 12 pzs Llaves combinadas (8, 9, 10, 11, 12, 13, 14, 15, 16, 17, 18, 19 mm) en una práctico estuche desmontable.	41	126,69



Juego de llaves de vaso 1/2"



7819DRN



7888DM

Ref.	Código	Piezas	Contenido	€ / u.
1215502	7819DRN	25	800DM (10 11 12 13 14 15 16 17 18 19 21 22 23 24 26 27 28 30 32 mm), 8150RN-1/2, 8154-1/2, 8152-1/2, 8160-1/2, 8162-1/2, 8166-1/2	359,36
1215600	7888DM	25	7800DM (10 11 12 13 14 15 16 17 18 19 21 22 23 24 25 27 30 32 mm), 8150-1/2, 8158-1/2, 8154-1/2, 8159-1/2, 8160-1/2, 8162-1/2, 8166-1/2	368,78

Juego de llaves de vaso 1/2", pulgadas



Ref.	Código	Contenido	Piezas	€ / u.
1271900	S240AF	15 piezas de 1/2" Vasos hexagonales con Perfil Dynamic Drive (AF 3/8 7/16 1/2 9/16 5/8 11/16 3/4 13/16 7/8 15/16 1 1-1/16 1-1/8 1-3/16 1-1/4") 2 piezas de 1/2" Barras de extensión de 5" y 10" 1 pieza de 1/2" Junta universal cardan 1 pieza de 1/2" Adaptador en T 2 piezas de 1/2" Vasos hexagonales con bocas para bujías de 5/8" (16 mm) y 13/16" (21 mm) 1 pieza de 1/2" Mango articulado de 10" 1 pieza de 1/2" Llave de carraca de 54 dientes	24	123,95



Juego de llaves de vaso 1/2", pasantes



S140T



S140T-R



S530T

Ref.	Código	Contenido	Piezas	€ / u.
1271950	S140T	12 pzs Vasos con accionamiento exterior 10, 11, 12, 13, 14, 15, 16, 17, 19, 21, 22, 24 mm. 1 pz Carraca con accionamiento exterior con cabeza flexible, 72 dientes/ Ángulo de acción 5° y mango bimaterial. 1 pz Alargadera con accionamiento exterior, 75 mm	14	70,90
1271951	S140T-R	1 pz Adaptador vaso 1/2" 1 pz Adaptador vaso 3/8" 1 pz Carraca con accionamiento exterior/agujero pasante, con cabeza flexible, 72 dientes/Ángulo de acción 5° y mango bimaterial	3	43,26
1271952	S530T	13 pzs Vasos : (10, 11, 12, 13, 14, 15, 16, 17, 18, 19, 21, 22, 24 mm) 1 pz Carraca con cabeza flexible, 72 dientes/ 5° de acción y mango de dos componentes. 1 pz Barra de extensión, 75 mm 10 pzs Adaptador cuadradillo con 6 pt : (8-9-10-11-12-13-14-15-16-17mm) 9 pzs Adaptadores cuadradillo E-torx : (E8-E10-E11-E12-E14-E16-E18-E20-E22) 8 pzs Puntas 5/16" x 25 mm (Zinc Fosfatado) HEX: 7, 8, 10, 12 y TTX: 40H, 45H, 50H, 55H 6 pzs Puntas 1/4" x 25mm (Zinc Fosfatado) HEX: 5, 6 y TTX: 20H, 25H, 27H, 30H 1 pz 19mm(3/4") DR.X1/4" Adaptador puntas 1 pz 19mm(3/4") DR.X5/16" Adaptador puntas 1 pz 19mm(3/4") DR.X3/8" Adaptador liberación rápida 1 pz 19mm(3/4") DR.X1/4" Adaptador liberación rápida 1 pz 19mm(3/4") JDR.X1/2" Adaptador liberación rápida	53	196,41

Juego de llaves de vaso



Carracas y vasos en Acero al Cromo Vanadio. 1/2": Carraca de 72 dientes reversible con expulsor de vasos. Vasos de 10 a 32 mm. Vasos largos, puntas y accesorios. 3/4": Carraca de 72 dientes reversible con expulsor de vasos. Vasos de 4 a 14 mm. Vasos hexagonales. Vasos largos, puntas y accesorios.



Ref.	Código	Contenido Piezas	€ / u.
8005589	3055	94	75,00

8767 C TORX HF 1 - Juego de vasos con punta TORX®, con función de retención



Juego de 9 piezas; en caja compacta de material textil para la protección de superficies, de gran robustez. Peso y volumen reducidos facilitan la movilidad. 9 Zyklop vasos de punta para tornillos TORX®, con arrastre de 1/2", con función sujeta-tornillos



Ref.	Código	Contenido	€ / u.
1213090	05004202001	8767 C HF 1 x TX 20x60; 1 x TX 25x60; 1 x TX 27x60; 1 x TX 30x60; 1 x TX 40x60; 1 x TX 45x60; 1 x TX 50x60; 1 x TX 55x60; 1 x TX 60x60	162,48

7809XZN - Vaso 1/2" con punta XZN



Ref.	Código	d mm	Entrecaras mm	L mm	Para tornillo Métrica	€ / u.
1271750	7809XZN-8	22	8	60	M 8	18,20
1271751	7809XZN-10	22	10	60	M 10	19,10
1271752	7809XZN-12	22	12	60	M 12	23,61
1271753	7809XZN-14	22	14	60	M 14	25,23
1271800	7809XZN-8-100	22	8	100	M 8	19,91
1271801	7809XZN-10-100	22	10	100	M 10	23,61
1271802	7809XZN-12-100	22	12	100	M 12	25,79
1271803	7809XZN-14-100	22	14	100	M 14	29,51



8790 HMC HF 1 - Juego de llaves de vaso Zyklop, con función de retención



Juego de 10 piezas; en caja compacta de material textil para la protección de superficies, de gran robustez. Peso y volumen reducidos facilitan la movilidad. 10 llaves de vaso Zyklop con arrastre de 1/2" con función de retención.



Ref.	Código	Contenido	€ / u.
1213045	05004203001	8790 HMC HF 1 x 10,0x37,0; 1 x 11,0x37,0; 1 x 12,0x37,0; 1 x 13,0x37,0; 1 x 14,0x37,0; 1 x 15,0x37,0; 1 x 16,0x37,0; 1 x 17,0x37,0; 1 x 18,0x37,0; 1 x 19,0x37,0	129,13

8100 SC 2 - Juego de carraca Zyklop Speed, cuadradillo de 1/2"



Ref.	Código	Contenido	€ / u.
		En resistente caja metálica, juego de 37 piezas. 1 carraca Zyklop con arrastre de 1/2". 17 llaves de vaso Zyklop [métrico]. 2 extensiones (corta y larga) Zyklop "sistema bloqueo flexible" con manguito de giro rápido. 1 extensión tipo "Wobble". 1 mango Zyklop en "T". 1 articulación cardán Zyklop. 1 adaptador con porta-puntas de cambio rápido. 13 puntas.	
1229450	05003645001	<ul style="list-style-type: none"> 8000 C 1 x 1/2" x 277,0 840/2 Z Hex-Plus 1 x 5x30; 1 x 6x30; 1 x 8x30; 1 x 10x30 851/2 Z PH 1 x PH 3x32 855/2 Z PZ 1 x PZ 3x32 867/2 Z TORX® 1 x TX 20x35; 1 x TX 25x35; 1 x TX 30x35; 1 x TX 40x35; 1xTX45x35; 1 x TX 50x35; 1 x TX 55x35 8784 C2 1 x 1/2" x 5/16" x 50,0 8789 C 1 x 1/2" x 250,0 8790 HMC 1 x 10,0x37,0; 1 x 11,0x37,0; 1 x 12,0x37,0; 1 x 13,0x37,0; 1 x 14,0x37,0; 1 x 15,0x37,0; 1 x 16,0x37,0; 1 x 17,0x37,0; 1 x 18,0x37,0; 1 x 19,0x37,0; 1 x 20,0x37,0; 1 x 21,0x37,0; 1 x 22,0x37,0; 1 x 24,0x37,0; 1 x 27,0x40,0; 1 x 30,0x42,0; 1 x 32,0x42,0 8794 C 1 x 1/2" x 52,0 8795 C 1 x 1/2" x 69,0 8796 LC 1 x 1/2" x 250,0 8796 SC 1 x 1/2" x 125,0 	666,89



8100 SC 6 - Juego de carraca Zyklop Speed, cuadradillo de 1/2"



Juego de 28 piezas; en caja compacta de material textil para la protección de superficies, de gran robustez. Peso y volumen reducidos facilitan la movilidad. 1 carraca Zyklop Speed con arrastre de 1/2", 10 vasos Zyklop, 1 prolongación Zyklop (larga) con manguito de giro rápido, 1 prolongación "Wobble", 1 pieza de conexión con porta-puntas de cambio rápido, 14 puntas

Ref.	Código	Contenido	€ / u.
1213890	05004076001	<ul style="list-style-type: none"> 8000 C 1 x 1/2"x277,0 8790 HMC 1 x 10,0x37,0; 1 x 11,0x37,0; 1 x 12,0x37,0; 1 x 13,0x37,0; 1 x 14,0x37,0; 1 x 15,0x37,0; 1 x 16,0x37,0; 1 x 17,0x37,0; 1 x 18,0x37,0; 1 x 19,0x37,0 8794 LC 1 x 1/2"x250,0 8794 C 1 x 1/2"x52,0 8784 C1 1 x 5/16"x1/2"x50,0 851/2 Z PH 1 x PH 2x32; 1 x PH 3x32 855/2 Z PZ 1 x PZ 2x32; 1 x PZ 3x32 867/2 Z Z TORX® 1 x TX 20x35; 1 x TX 25x35; 1 x TX 30x35; 1 x TX 40x35; 1 x TX 45x35; 1 x TX 50x35 840/2 Z 1 x 5x30; 1 x 6x30; 1 x 8x30; 1 x 10x30 	346,69



8006 SC 1 - Juego de carraca Zyklop Hybrid, cuadradillo de 1/2"



Juego de 13 piezas; en caja compacta de material textil para la protección de superficies, de gran robustez. Peso y volumen reducidos facilitan la movilidad. 1 carraca Zyklop Hybrid con arrastre de 1/2", 10 vasos Zyklop con función sujeta-tornillos, 1 prolongación Zyklop Hybrid con perno de desbloqueo, 1 prolongación Zyklop (larga) con manguito de giro rápido

Ref.	Código	Contenido	€ / u.
1213875	05005746001	<ul style="list-style-type: none"> 8006 C 1 x 1/2"x281,0 8797 C 1 x 271,0 8794 LC 1 x 1/2"x250,0 8790 HMC HF 1 x 10,0x37,0; 1 x 11,0x37,0; 1 x 12,0x37,0; 1 x 13,0x37,0; 1 x 14,0x37,0; 1 x 15,0x37,0; 1 x 16,0x37,0; 1 x 17,0x37,0; 1 x 18,0x37,0; 1 x 19,0x37,0 	338,75





8900 - Llave de vaso 3/4"

ISO 2725 - 1174 • DIN 3124 - 3120. Acero cromo vanadio tratado. Cromadas. Para trabajo manual. No trabajar a impacto. Pitón facilitando el desbloqueo del vaso.

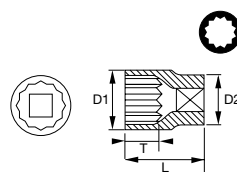
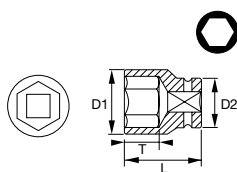

8900SM Boca hexagonal

Ref.	Código	Entrecaras mm	D1 mm	D2 mm	L mm	€/ u.
1216401	8900SM-22	22	33.0	40	47	18,03
1216403	8900SM-24	24	35.5	40	50	19,35
1216406	8900SM-27	27	38.5	40	53	19,99
1216409	8900SM-30	30	42.5	40	58	22,40
1216410	8900SM-32	32	45.0	40	58	23,36
1216412	8900SM-34	34	48.0	40	60	24,85
1216414	8900SM-36	36	50.0	40	63	27,02
1216415	8900SM-38	38	52.0	40	66	28,75
1216417	8900SM-41	41	56.0	40	66	31,68
1216419	8900SM-46	46	62.5	40	68	37,38
1216420	8900SM-50	50	67.5	40	68	42,60
1216421	8900SM-55	55	74.0	45	69	51,25
1216422	8900SM-60	60	80.5	45	72	56,98

8900DM Boca bihexagonal

Ref.	Código	Entrecaras mm	D1 mm	D2 mm	L mm	€/ u.
1216500	8900DM-19	19	29.5	40	47	17,79
1216501	8900DM-22	22	33.0	40	47	18,31
1216503	8900DM-24	24	35.5	40	50	19,61
1216504	8900DM-25	25	36.5	40	53	19,05
1216506	8900DM-27	27	38.5	40	53	19,99
1216507	8900DM-28	28	40.0	40	53	20,97
1216509	8900DM-30	30	42.5	40	58	22,40
1216510	8900DM-32	32	45.0	40	58	23,36
1216512	8900DM-34	34	48.0	40	60	24,85
1216514	8900DM-36	36	50.0	40	63	27,02
1216517	8900DM-41	41	56.0	40	66	31,68
1216519	8900DM-46	46	62.5	40	68	37,38
1216520	8900DM-50	50	67.5	40	68	42,59
1216521	8900DM-55	55	74.0	45	69	51,26
1216522	8900DM-60	60	80.5	45	72	56,98

8900DZ Boca bihexagonal, pulgadas

Ref.	Código	Entrecaras "	D1 mm	D2 mm	L mm	€/ u.
1216602	8900DZ-15/16	15/16	35.5	40	50	19,58
1216603	8900DZ-1	1	36.5	40	53	19,74
1216604	8900DZ-1.1/16	1.1/16	38.5	40	53	20,39
1216605	8900DZ-1.1/8	1.1/8	40.0	40	53	21,38
1216607	8900DZ-1.1/4	1.1/4	45.0	40	58	23,63
1216608	8900DZ-1.5/16	1.5/16	48.5	40	61	25,63
1216609	8900DZ-1.3/8	1.3/8	48.5	40	63	25,63

Ref.	Código	Entrecaras "	D1 mm	D2 mm	L mm	€/ u.
1216611	8900DZ-1.1/2	1.1/2	52.0	40	66	28,97
1216613	8900DZ-1.5/8	1.5/8	56.0	40	66	32,63
1216615	8900DZ-1.3/4	1.3/4	62.5	40	68	37,86
1216616	8900DZ-1.13/16	1.13/16	62.5	40	68	37,86
1216617	8900DZ-1.7/8	1.7/8	64.5	40	68	43,12
1216618	8900DZ-2	2	67.5	40	68	43,12

6400M - Llave vaso 3/4" cromado, hexagonal-corto. Métrica y pulgadas



01

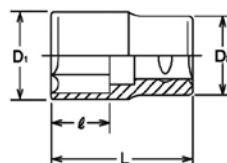

Ref.	Código	€ / u.	Ref.	Código	€ / u.	Entrecaras *	Entrecaras mm	D1 mm	D2 mm	Longitud mm	l
1200520	8K6400M17	14,82				-	17	26	34	50	12,5
1200521	8K6400M18	14,82	1200570	8K6400A11/16	15,52	11/16	18	27	34	50	13
1200522	8K6400M19	14,82	1200571	8K6400A3/4	15,52	3/4	19	28,5	34	50	13,5
1200523	8K6400M20	14,82				-	20	29,5	34	50	14
1200524	8K6400M21	14,82	1200573	8K6400A13/16	15,52	13/16	21	31	34	50	14,5
1200525	8K6400M22	14,82	1200574	8K6400A7/8	15,52	7/8	22	32	34	50	15
1200526	8K6400M23	14,82				-	23	33,5	34	50	16
1200527	8K6400M24	15,67	1200575	8K6400A15/16	16,60	15/16	24	34,5	34	50	17
1200528	8K6400M25	15,67				31/32	25	36	34	50	17,5
1200529	8K6400M26	15,67	1200577	8K6400A1	16,60	1	26	37	34	50	18
1200530	8K6400M27	16,60	1200578	8K6400A11/16	17,29	1-1/16	27	38,5	37	53	19
1200531	8K6400M28	16,78				-	28	39,5	38	53	19,5
1200532	8K6400M29	19,15	1200579	8K6400A11/8	20,20	1-1/8	29	41	38	55	20
1200533	8K6400M30	19,15	1200580	8K6400A13/16	20,20	1-3/16	30	42	38	55	21
1200534	8K6400M31	19,15				-	31	43,5	38	57	22
1200535	8K6400M32	19,15	1200581	8K6400A11/4	20,20	1-1/4	32	44,5	40	57	23
1200536	8K6400M33	22,97	1200582	8K6400A15/16	24,17	1-5/16	33	46	40	57	23,5
1200537	8K6400M34	22,97				-	34	47	40	57	24
1200538	8K6400M35	22,97	1200583	8K6400A13/8	24,17	1-3/8	35	48,5	42	59	24,5
1200539	8K6400M36	25,65				-	36	49,5	42	59	25
1200540	8K6400M37	25,65	1200584	8K6400A17/16	26,89	1-7/16	37	51	42	59	25,5
1200541	8K6400M38	26,72	1200585	8K6400A11/2	28,14	1-1/2	38	52	45	59	26
1200542	8K6400M39	30,50				-	39	53,5	45	59	26,5
1200543	8K6400M40	30,50	1200586	8K6400A19/16	31,99	1-9/16	40	54,5	45	62	27
1200544	8K6400M41	30,50	1200587	8K6400A15/8	31,99	1-5/8	41	56	47	62	28
1200545	8K6400M42	32,63				-	42	57	47	62	28,5
1200546	8K6400M43	34,47	1200588	8K6400A111/16	36,31	1-11/16	43	58,5	47	62	29
1200547	8K6400M44	37,77	1200589	8K6400A13/4	39,17	1-3/4	44	59,5	47	62	29,5
1200548	8K6400M45	37,77				-	45	61	47	68	30
1200549	8K6400M46	37,77	1200590	8K6400A113/16	39,17	1-13/16	46	62	47	68	31
1200550	8K6400M47	40,96				-	47	63,5	48	68	31,5
1200551	8K6400M48	40,96	1200591	8K6400A17/8	42,94	1-7/8	48	64,5	45	68	32
			1200592	8K6400A115/16	48,01	1-15/16	-	66	48	68	32,5
1200552	8K6400M50	45,65				-	50	67	48	68	34
			1200593	8K6400A2	52,66	2	-	68,5	52	68	34,5
1200553	8K6400M52	52,35				-	52	69,5	53	72	33
			1200594	8K6400A21/16	55,20	2-1/16	-	71	54	72	33
1200554	8K6400M54	55,41	1200595	8K6400A21/8	58,07	2-1/8	54	72	55	72	33
1200555	8K6400M55	55,41				-	55	73,5	53	72	36
1200556	8K6400M56	55,41	1200596	8K6400A23/16	58,07	2-3/16	56	74,5	53	72	36
1200557	8K6400M57	55,41	1200597	8K6400A21/4	58,07	2-1/4	57	76	53	72	36
1200558	8K6400M58	58,07				-	58	77	53	72	36
			1200598	8K6400A25/16	77,07	2-5/16	-	78,5	53	72	36
1200559	8K6400M60	73,22	1200599	8K6400A23/8	77,07	2-3/8	60	79,5	58	76	39
1200560	8K6400M63	73,22				-	63	83,5	58	76	39
			1200601	8K6400A21/2	77,07	2-1/2	-	84,5	58	76	39
1200561	8K6400M65	86,21				2-9/16	65	86	63	80	42
			1200603	8K6400A25/8	98,50	2-5/8	-	88,5	63	80	42
			1200604	8K6400A211/16	98,50	2-11/16	-	89,5	63	80	42
1200562	8K6400M70	95,61	1200605	8K6400A23/4	100,87	2-3/4	70	92	68	84	45
						2-13/16	-	94,5	68	84	45
			1200607	8K6400A27/8	100,87	2-7/8	-	96	68	84	45
1200563	8K6400M75	122,86				2-15/16	75	98,5	73	86	48
			1200609	8K6400A3	129,00	3	-	101	73	86	48
1200564	8K6400M80	131,90	1200610	8K6400A31/8	138,54	3-1/8	80	104,5	78	90	52





Llave vaso 3/4" cromado, Bihexagonal-corto. Métrica y pulgadas

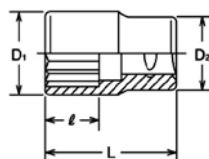

Ref.	Código	€ / u.	Ref.	Código	€ / u.	Entrecaras "	Entrecaras mm	D1 mm	D2 mm	L mm	l
1200611	8K6405M17	14,82				-	17	26	34	50	12,5
1200612	8K6405M18	14,82				11/16	18	27	34	50	13
1200613	8K6405M19	14,82	1200658	8K6405A3/4	15,52	3/4	19	28,5	34	50	13,5
1200614	8K6405M20	14,82	1200659	8K6405A25/32	15,52	25/32	20	29,5	34	50	14
1200615	8K6405M21	14,82	1200660	8K6405A13/16	15,52	13/16	21	31	34	50	14,5
1200616	8K6405M22	14,82	1200661	8K6405A7/8	15,52	7/8	22	32	34	50	15
1200617	8K6405M23	14,82				-	23	33,5	34	50	16
1200618	8K6405M24	15,67	1200662	8K6405A15/16	16,60	15/16	24	34,5	34	50	17
1200619	8K6405M25	15,67				31/32	25	36	34	50	17,5
1200620	8K6405M26	15,67	1200664	8K6405A1	16,60	1	26	37	34	50	18
1200621	8K6405M27	16,60	1200665	8K6405A11/16	17,29	1-1/16	27	38,5	37	53	19
1200622	8K6405M28	16,78				-	28	39,5	38	53	19,5
1200623	8K6405M29	19,15	1200666	8K6405A11/8	20,20	1-1/8	29	41	38	55	20
1200624	8K6405M30	19,15	1200667	8K6405A13/16	20,20	1-3/16	30	42	38	55	21
1200625	8K6405M31	19,15				-	31	43,5	38	57	22
1200626	8K6405M32	19,15	1200668	8K6405A11/4	20,20	1-1/4	32	44,5	40	57	23
1200627	8K6405M33	22,97	1200669	8K6405A15/16	24,17	1-5/16	33	46	40	57	23,5
1200628	8K6405M34	22,97				-	34	47	40	57	24
1200629	8K6405M35	22,97	1200670	8K6405A13/8	24,17	1-3/8	35	48,5	42	59	24,5
1200630	8K6405M36	25,65				-	36	49,5	42	59	25
1200631	8K6405M37	25,65	1200671	8K6405A17/16	26,89	1-7/16	37	51	42	59	25,5
1200632	8K6405M38	26,72	1200672	8K6405A11/2	28,14	1-1/2	38	52	45	59	26
1200633	8K6405M39	30,50				-	39	53,5	45	59	26,5
1200634	8K6405M40	30,50	1200673	8K6405A19/16	31,99	1-9/16	40	54,5	45	62	27
1200635	8K6405M41	30,50	1200674	8K6405A15/8	31,99	1-5/8	41	56	47	62	28
1200636	8K6405M42	32,63				-	42	57	47	62	28,5
1200637	8K6405M43	34,47	1200675	8K6405A111/16	36,31	1-11/16	43	58,5	47	62	29
1200638	8K6405M44	37,77	1200676	8K6405A13/4	39,17	1-3/4	44	59,5	47	62	29,5
1200639	8K6405M45	37,77				-	45	61	47	68	30
1200640	8K6405M46	37,77	1200677	8K6405A113/16	39,17	1-13/16	46	62	47	68	31
1200641	8K6405M47	40,96				-	47	63,5	48	68	31,5
1200642	8K6405M48	40,96	1200678	8K6405A17/8	42,94	1-7/8	48	64,5	45	68	32
			1200679	8K6405A115/16	48,01	1-15/16	-	66	48	68	32,5
1200643	8K6405M50	45,65				-	50	67	48	68	34
			1200680	8K6405A2	52,66	2	-	68,5	52	68	34,5
1200644	8K6405M52	52,35				-	52	69,5	53	72	33
			1200681	8K6405A21/16	55,20	2-1/16	-	71	54	72	33
1200645	8K6405M54	55,41	1200682	8K6405A21/8	58,07	2-1/8	54	72	55	72	33
1200646	8K6405M55	55,41				-	55	73,5	53	72	36
1200647	8K6405M56	55,41	1200683	8K6405A23/16	58,07	2-3/16	56	74,5	53	72	36
1200648	8K6405M57	55,41	1200684	8K6405A21/4	58,07	2-1/4	57	76	53	72	36
1200649	8K6405M58	58,07				-	58	77	53	72	36
						2-5/16	-	78,5	53	72	36
1200650	8K6405M60	73,22	1200686	8K6405A23/8	77,07	2-3/8	60	79,5	58	76	39
			1200687	8K6405A27/16	77,07	2-7/16	-	82	58	76	39
1200651	8K6405M63	73,22				-	63	83,5	58	76	39
			1200688	8K6405A21/2	77,07	2-1/2	-	84,5	58	76	39
1200652	8K6405M65	86,21	1200689	8K6405A29/16	90,96	2-9/16	65	86	63	80	42
						2-5/8	-	88,5	63	80	42
			1200691	8K6405A211/16	98,49	2-11/16	-	89,5	63	80	42
1200653	8K6405M70	95,61	1200692	8K6405A23/4	100,86	2-3/4	70	92	68	84	45
			1200693	8K6405A213/16	100,87	2-13/16	-	94,5	68	84	45
			1200694	8K6405A27/8	100,87	2-7/8	-	96	68	84	45
1200654	8K6405M75	122,86	1200695	8K6405A215/16	110,15	2-15/16	75	98,5	73	86	48
			1200696	8K6405A3	110,15	3	-	101	73	86	48
1200655	8K6405M80	131,90	1200697	8K6405A31/8	110,15	3-1/8	80	104,5	78	90	52
1200656	8K6405M85	140,90				-	85	111	78	90	52

928ME Llave de vaso 3/4" punta hexagonal



Fabricado en una sola pieza

Ref.	Código	Entrecaras mm	Ø mm	L mm	L1 mm	€/ u.
8005184	9280514	14	35	75	15,5	38,50
8005185	9280517	17	35	75	15,5	38,50
8005186	9280519	19	35	75	15,5	38,50
8005187	9280522	22	35	75	22,5	42,50



59 X - Cabeza de destornillador 3/4" XZN®



Para tornillos de dentado múltiple interior (XZN®). Cromo. Aleación acero. Cromadas.

Ref.	Código	Medida	d mm	L1 mm	L2 mm	€/ u.
1217850	05060014	M14	34,7	90	35	49,85
1217851	05060016	M16	34,7	80	25	52,20
1217852	05060018	M18	34,7	100	45	58,80



59 TX - Cabeza de destornillador 3/4" TORX®



Para tornillos de interior TORX®. Cromo. Aleación acero. Cromadas.

Ref.	Código	Punta torx	d mm	L1 mm	L2 mm	Torx en mm	€/ u.
1217860	05100060	T60	34,7	80	25	13,2	52,60
1217861	05100070	T70	34,7	80	25	15,5	55,80
1217862	05100080	T80	34,7	80	25	17,6	58,30
1217863	05100090	T90	34,7	80	25	19,9	62,75
1217864	05100100	T100	40	80	25	22,1	65,70



8954A - Cabeza mango corredizo 3/4"



ISO 1174 · DIN 3120. Puede utilizarse junto al mango 7446.

Ref.	Código	Longitud mm	€/ u.
1217300	8954A	62	36,66



8963 - Mango acodado 3/4"



UNE 16512 · ISO 3315 - 1174 · DIN 3122 - 3120. Acero cromo vanadio, tratado cromado.

Ref.	Código	Longitud mm	€/ u.
1217400	8963	415	39,56

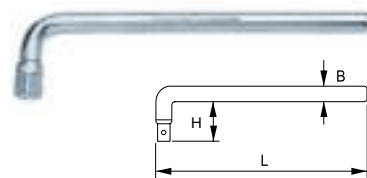

8958A - Cabeza mango articulado 3/4"



UNE 16512 · ISO 3315 - 1174 · DIN 3122 - 3120. Acero cromo vanadio tratado. Cromada.

Ref.	Código	Longitud mm	€/ u.
1217500	8958A	125	92,95

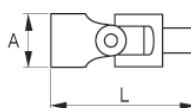

6644A - Adaptador 3/4"-1/2"



Ref.	Código	L mm	€ / u.
2400040	8K6644A	47	18,54



6688A - Adaptador 3/4"-1"



Ref.	Código	L mm	€ / u.
2400041	8K6688A	60	26,01



8966 - Articulación 3/4"



UNE 16511 · ISO 3316 - 1174 · DIN 3122 - 3123 - 3120.
Acero cromo vanadio tratado. Cromada.

Ref.	Código	Longitud mm	€ / u.
1217700	8966	103,5	94,65

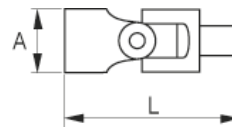

8952N/B - Mango de carraca 3/4"



DIN 3122 · ISO 3315. Para utilización con ref. 8952N/A.

Ref.	Código	Longitud mm	€ / u.
1217100	8952N/B	450	23,43



Juego de llaves de vaso 3/4"



8845NM



8845DM



8840M

Ref.	Código	Piezas	Contenido	€ / u.
1218000	8845NM	15	8900SM (22 24 27 30 32 36 38 41 46 50 mm), 8953, 8950N/A, 8954A, 8961, 8962	583,74
1218001	8845DM	15	8900DM (19 22 24 27 30 32 36 41 46 50 mm), 8953, 8950N/A, 8954A, 8961, 8962	574,59
1218002	8840M	24	8900DM (19 22 24 25 27 28 30 32 36 41 46 50 55 60 mm), 8953, 8950N/A, 8954A, 8961, 8962, 8951, 8966, 8964, 8965, 8958A	1.204,85

9500 - Llave de vaso 1"



ISO 2725 - 1174 - DIN 3124 - 3120.
 Acero cromo vanadio tratado.
 Para uso manual.
 Pitón facilitando el desbloqueo del vaso.
 Boca hexagonal.

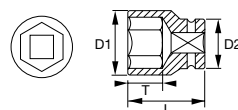

Ref.	Código	Entrecaras mm	D1 mm	D2 mm	L mm	€/ u.
1218400	9500SM-41	41	57	48	67	46,68
1218401	9500SM-46	46	63	48	71	54,44
1218402	9500SM-50	50	69	48	74	60,22
1218403	9500SM-54	54	74	48	78	64,18
1218404	9500SM-55	55	75	54	79	68,55
1218405	9500SM-58	58	79	54	82	74,92
1218406	9500SM-60	60	82	54	83	83,73
1218407	9500SM-63	63	86	54	85	93,85

Ref.	Código	Entrecaras mm	D1 mm	D2 mm	L mm	€/ u.
1218408	9500SM-65	65	88	54	86	100,08
1218409	9500SM-67	67	90	54	89	106,59
1218410	9500SM-70	70	94	60	91	112,44
1218411	9500SM-71	71	95	60	92	118,34
1218412	9500SM-75	75	101	60	95	125,85
1218413	9500SM-77	77	103	60	98	133,85
1218414	9500SM-80	80	108	60	101	143,32
1218415	9500SM-82	82	110	60	104	152,81

8400M - Llave de vaso 1"



Ref.	Código	Entrecaras mm	D1 mm	D2 mm	L mm	€/ u.
1500027	8K8400M27	27	40,5	45	60	37,74
1500030	8K8400M30	30	44	54	65	37,74
1500032	8K8400M32	32	46,5	45	65	37,74
1500033	8K8400M33	33	48	46	65	37,74
1500035	8K8400M35	35	50,5	48	65	37,74
1500036	8K8400M36	36	51,5	48	65	37,74
1500038	8K8400M38	38	54	50	65	37,74
1500040	8K8400M40	40	56,5	53	65	37,74
1500041	8K8400M41	41	58	53	68	44,70
1500042	8K8400M42	42	59	53	68	49,63
1500046	8K8400M46	46	64	53	72	49,67
1500050	8K8400M50	50	69	53	72	54,84
1500054	8K8400M54	54	74	55	72	67,09
1500055	8K8400M55	55	75,5	53	77	69,98
1500058	8K8400M58	58	79	53	77	74,89

Ref.	Código	Entrecaras mm	D1 mm	D2 mm	L mm	€/ u.
1500060	8K8400M60	60	81,5	58	82	84,22
1500063	8K8400M63	63	85,5	58	82	94,69
1500065	8K8400M65	65	88	63	86	99,07
1500067	8K8400M67	67	90,5	63	86	106,09
1500068	8K8400M68	68	91,5	63	86	106,09
1500070	8K8400M70	70	94	68	88	116,50
1500071	8K8400M71	71	95,5	68	88	125,57
1500075	8K8400M75	75	100,5	73	90	146,46
1500080	8K8400M80	80	106,5	75	95	155,17
1500083	8K8400M83	83	110,5	78	95	162,19
1500085	8K8400M85	85	113	80	95	162,19
1500090	8K8400M90	90	119	80	100	246,45
1500095	8K8400M95	95	125,5	85	100	287,03
1500100	8K8400M100	100	131,5	85	100	292,57

9555 - Mango corredizo 1"



ISO 3315 - 1174 - DIN 3122 - 3120.
 Acero cromo vanadio tratado. Cromado. Con pitón escamoteable.

Ref.	Código	Longitud mm	€/ u.
1218900	9555	508	100,07

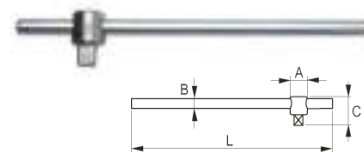

9555AB - Cabeza mango corredizo 1"



ISO 1174 - DIN 3120. Puede utilizarse junto al mango 9550.

Ref.	Código	Longitud mm	€/ u.
1219000	9555AB	78	46,75



9560AB - Extensión 1"



ISO 3316 - 1174 • DIN 3123 - 3120 • UNE 16511.
Acero cromo vanadio tratado. Cromada.

Ref.	Código	Longitud mm	€ / u.
1219100	9560AB	200	75,71
1219101	9563AB	400	96,99

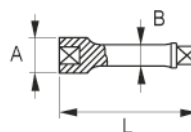

8866A - Adaptador 1"



Ref.	Código	L mm	€ / u.
2400042	8K8866A	60	25,83



Juego de llaves de vaso 1"



Caja metálica. Dimensiones de la caja: 560 x 210 x 120.

Ref.	Código	Contenido	Composición	€ / u.
1219300	9540MB	8 + 4	9500SM (46 50 55 60 65 70 75 80 mm), 9550AB, 9554AB, 9560AB, 9563AB	1.154,73
1219400	9540MBL	14 + 5	9500SM (46 50 54 55 58 60 63 65 67 70 71 75 77 80 mm), 9550AB, 9554AB, 9560 & 9563, 9565	1.707,50



K6701M - Vaso de impacto 1/4", corto



DIN 3129 - ISO 2725. Cromo.
Aleación acero. Cromadas.

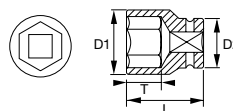

Ref.	Código	Entrecaras mm	D1 mm	D2 mm	L mm	Muelle de fijación	€ / u.
1272000	K6701M-6	6	10.2	13	22	K560F-1	7,35
1272001	K6701M-7	7	11.5	13	22	K560F-1	7,35
1272002	K6701M-8	8	12.7	13	22	K560F-1	7,39
1272003	K6701M-9	9	14	13	22	K560F-1	7,39
1272004	K6701M-10	10	15.2	13	22	K560F-1	7,39

Ref.	Código	Entrecaras mm	D1 mm	D2 mm	L mm	Muelle de fijación	€ / u.
1272005	K6701M-11	11	15.4	13	22	K560F-1	7,39
1272006	K6701M-12	12	17.4	13	22	K560F-1	9,21
1272007	K6701M-13	13	19	13	22	K560F-1	9,21
1272008	K6701M-14	14	20.5	13	23	K560F-1	9,21

12400M - Vaso Impacto 1/4, corto



Ref.	Código	Entrecaras mm	L mm	€ / u.
8001076	8K12400M10	10	23	5,19
8001077	8K12400M11	11	23	5,19
8001078	8K12400M12	12	23	5,19
8001079	8K12400M13	13	23	5,19
8001080	8K12400M14	14	23	5,63
8001081	8K12400M4	4	23	4,80
8001082	8K12400M45	4,5	23	4,80

Ref.	Código	Entrecaras mm	L mm	€ / u.
8001083	8K12400M5	5	23	4,80
8001084	8K12400M55	5,5	23	5,49
8001085	8K12400M6	6	23	4,80
8001086	8K12400M7	7	23	4,80
8001087	8K12400M8	8	23	4,80
8001088	8K12400M9	9	23	4,80



KM6701M - Vaso de impacto 1/4", largo



DIN 3129 - ISO 2725.
Cromo. Aleación acero. Cromadas.
Con Perfil Dynamic Drive.

Ref.	Código	Entrecaras mm	D1 mm	D2 mm	L mm	Muelle de fijación	€ / u.
1272050	KM6701M-7	7	11.5	13	28	K560F-1	31,56
1272051	KM6701M-8	8	12.7	13	28	K560F-1	31,95
1272052	KM6701M-10	10	15.2	13	28	K560F-1	32,96

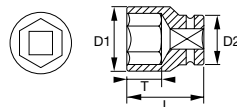

K7401M - Vaso de impacto 3/8", corto



DIN 3129 - ISO 2725.
Acero aleado especial, tratado pavonadas.
Con Perfil Dynamic Drive.

Ref.	Código	Entrecaras mm	D1 mm	D2 mm	L mm	Muelle de fijación	€ / u.
1220100	K7401M-7	7	12.5	19	26	K560F-2	8,70
1220101	K7401M-8	8	12.9	19	26	K560F-2	8,70
1220102	K7401M-9	9	14.5	19	26	K560F-2	8,70
1220103	K7401M-10	10	15.9	19	26	K560F-2	8,70
1220104	K7401M-11	11	16.7	19	27	K560F-2	8,70
1220105	K7401M-12	12	18	19	27	K560F-2	8,70
1220106	K7401M-13	13	19.7	22	27	K560F-3	8,70
1220107	K7401M-14	14	20.5	22	27	K560F-3	8,70
1220108	K7401M-15	15	21.2	22	28	K560F-3	8,70

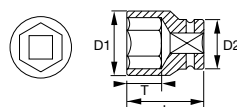

Ref.	Código	Entrecaras mm	D1 mm	D2 mm	L mm	Muelle de fijación	€ / u.
1220109	K7401M-16	16	22.8	22	28	K560F-3	8,70
1220110	K7401M-17	17	24.5	22	29	K560F-3	8,70
1220111	K7401M-18	18	26.3	22	29	K560F-3	10,34
1220112	K7401M-19	19	26.8	22	30	K560F-3	10,34
1220113	K7401M-20	20	28.5	22	31	K560F-3	10,63
1220114	K7401M-21	21	29.3	22	31	K560F-3	10,63
1220115	K7401M-22	22	30	22	33	K560F-3	11,12
1220117	K7401M-24	24	33.2	22	34	K560F-3	11,29

13400 - Vaso de impacto 3/8", corto



Ref.	Código	Entrecaras mm	L mm	€ / u.
8001089	8K13400M10	10	32	6,51
8001090	8K13400M11	11	32	6,51
8001091	8K13400M12	12	32	6,51
8001092	8K13400M13	13	32	6,51
8001093	8K13400M14	14	32	6,51
8001094	8K13400M15	15	32	7,17
8001095	8K13400M16	16	32	7,17
8001096	8K13400M17	17	32	7,16
8001097	8K13400M18	18	32	7,17
8001098	8K13400M19	19	32	7,16

Ref.	Código	Entrecaras mm	L mm	€ / u.
8001099	8K13400M20	20	32	8,51
8001100	8K13400M21	21	32	8,51
8001101	8K13400M22	22	32	9,06
8001102	8K13400M23	23	32	10,65
8001103	8K13400M24	24	32	14,04
8001104	8K13400M6	6	32	6,51
8001105	8K13400M7	7	32	6,51
8001106	8K13400M8	8	32	6,51
8001107	8K13400M9	9	32	6,51



K7406M - Vaso de impacto 3/8", largo



Ref.	Código	Entrecaras mm	D1 mm	D2 mm	L mm	Muelle de fijación	€ / u.
1220200	K7406M-10	10	15.9	19	54	K560F-2	9,73
1220201	K7406M-13	13	19.7	19	54	K560F-2	11,05
1220202	K7406M-17	17	24.5	22	66	K560F-3	12,05

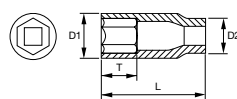



K7760C - Extensión impacto 3/8"

Acero aleado especial, tratado pavonadas. Con pasador accionado por muelle.

Ref.	Código	Cuadrado interior"	Cuadrado Exterior	L mm	Muelle de fijación	Ø mm	€ / u.
1220300	K7760C-1	3/8	3/8	75	K560F-2	19	16,02
1220301	K7760C-2	3/8	3/8	150	K560F-2	19	23,03



K7767S - Articulación impacto 3/8"

Ángulo máximo 35°. Con pasador accionado por muelle.

Ref.	Código	Cuadrado interior"	Cuadrado Exterior	Longitud mm	Muelle de fijación	Ø mm	€ / u.
1220400	K7767S	3/8	3/8	49	K560F-3	24	33,88

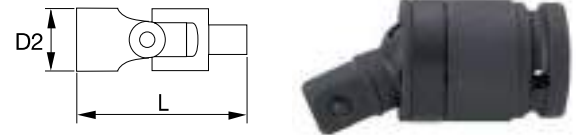

Aumentador y reductor

Ref.	Código	Cuadrado interior"	Cuadrado Exterior	Longitud mm	Muelle de fijación	Ø mm	€ / u.
1273000	K6964C	1/4"	3/8"	30	K560F-2	19	23,20
1273001	K8164C	1/2"	3/8"	35	K560F-2	19	23,20

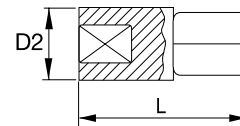

K7801 - Vaso de impacto 1/2", corto

DIN 3129 · ISO 2725. Con Perfil Dynamic Drive. Acero aleado especial, tratado, pavonadas.

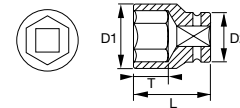

Ref.	Código	Entrecaras mm	D1 mm	D2 mm	L mm	Muelle de fijación	€ / u.
1220800	K7801M-8	8	15	25	38	K560F-4	6,08
1220801	K7801M-9	9	16	25	38	K560F-4	6,08
1220802	K7801M-10	10	17	25	38	K560F-4	10,29
1220803	K7801M-11	11	18.5	25	38	K560F-4	10,29
1220804	K7801M-12	12	19.5	25	38	K560F-4	10,29
1220805	K7801M-13	13	21	25	38	K560F-4	10,29
1220806	K7801M-14	14	22.5	25	38	K560F-4	10,65
1220807	K7801M-15	15	23	30	38	K560F-4	10,86
1220808	K7801M-16	16	25	30	38	K560F-4	10,86
1220809	K7801M-17	17	26	30	38	K560F-5	11,37
1220810	K7801VM-17	17	30	30	45	K560F-5	12,96
1220811	K7801M-18	18	27.5	30	38	K560F-5	11,37
1220812	K7801M-19	19	28.5	30	38	K560F-5	11,37

Ref.	Código	Entrecaras mm	D1 mm	D2 mm	L mm	Muelle de fijación	€ / u.
1220813	K7801VM-19	19	33	30	45	K560F-5	12,96
1220814	K7801M-20	20	30	30	38	K560F-5	11,99
1220815	K7801M-21	21	31	30	38	K560F-5	12,06
1220816	K7801M-22	22	32.5	30	38	K560F-5	12,20
1220817	K7801M-23	23	34	30	38	K560F-5	12,57
1220818	K7801M-24	24	35	30	38	K560F-5	12,76
1220819	K7801M-25	25	36	30	45	K560F-5	14,77
1220820	K7801M-26	26	37.5	30	45	K560F-5	15,18
1220821	K7801M-27	27	38.5	30	45	K560F-5	15,18
1220822	K7801M-30	30	42	30	50	K560F-5	18,60
1220823	K7801M-32	32	44	38	50	K560F-5	26,64
1220824	K7801M-34	34	45	38	50	K560F-6	30,09
1220825	K7801M-36	36	48	38	50	K560F-6	31,10

14400M - Vaso de impacto 1/2"



01



Ref.	Código	Entrecaras mm	D1 mm	D2 mm	L mm	€ / u.
1510008	8K14400M8	8	14,5	25	38	8,03
1510009	8K14400M9	9	15,7	25	38	8,03
1510010	8K14400M10	10	17	25	38	8,03
1510011	8K14400M11	11	18,2	25	38	8,03
1510012	8K14400M12	12	19,5	25	38	8,03
1510013	8K14400M13	13	20,7	25	38	8,03
1510014	8K14400M14	14	22	25	38	8,03
1510015	8K14400M15	15	23,2	30	38	8,92
1510016	8K14400M16	16	24,5	30	38	8,92
1510017	8K14400M17	17	25,7	30	38	8,92
1510018	8K14400M18	18	27	30	38	8,92
1510019	8K14400M19	19	28,2	30	38	8,92
1510020	8K14400M20	20	29,5	30	38	10,16
1510021	8K14400M21	21	30,7	30	38	10,16
1510022	8K14400M22	22	32	30	38	10,48

Ref.	Código	Entrecaras mm	D1 mm	D2 mm	L mm	€ / u.
1510023	8K14400M23	23	33,2	30	38	11,64
1510024	8K14400M24	24	34,5	30	38	11,64
1510025	8K14400M25	25	35,7	30	38	11,64
1510026	8K14400M26	26	37	30	38	12,48
1510027	8K14400M27	27	38,2	30	40	15,68
1510028	8K14400M28	28	39,5	30	40	15,68
1510029	8K14400M29	29	40,7	30	42	16,38
1510030	8K14400M30	30	42	30	42	16,35
1510031	8K14400M31	31	43,2	30	42	16,38
1510032	8K14400M32	32	44,5	30	42	16,68
1510033	8K14400M33	33	45,7	30	46	21,05
1510034	8K14400M34	34	47	30	46	24,38
1510035	8K14400M35	35	48,2	30	46	25,54
1510036	8K14400M36	36	48,5	30	46	25,54
1510041	8K14400M41	41	55,7	30	55	43,68

Vaso de impacto 1/2", bihexagonal



Los productos de Ozat se fabrican de acuerdo con las normas ANSI B107, DIN 3121, 3129 e ISO 2725, con tecnología de mecanizado electroquímico, único en su género, en acero aleado al Cromo Molybdeno 42 Cr Mo4 de alta calidad, para obtener un alto grado de dureza y resistencia. Los vasos de impacto de Ozat están diseñados (bajo sistema "Less-Stress"™) con la más alta tecnología, para cargas de trabajo continuadas, que permite tener holgura en la esquina y refuerzo especial en el punto de carga del flanco de la turca o tornillo.



Ref.	Código	Entrecaras "	Entrecaras mm	€ / u.
1485030	CE08M08DH	-	8	11,55
1485031	CE08M09DH	-	9	11,55
1485032	CE0806DH	3/8"	-	11,70
1485033	CE08M10DH	-	10	11,55
1485034	CE08M11DH	-	11	11,55
1485035	CE0807DH	7/16"	-	12,78
1485036	CE08M12DH	-	12	11,77
1485037	CE0808DH	1/2"	-	11,70
1485038	CE08M13DH	-	13	11,77
1485039	CE08M14DH	-	14	11,77
1485040	CE0809DH	9/16"	-	11,70
1485041	CE08M15DH	-	15	14,71
1485042	CE0810DH	5/8"	-	14,71
1485043	CE08M16DH	-	16	14,71
1485044	CE08M17DH	-	17	14,94
1485045	CE0811DH	11/16"	-	15,40
1485046	CE08M18DH	-	18	14,94
1485047	CE0812M19DH	3/4"	19	16,60
1485048	CE08M20DH	-	20	15,96
1485049	CE0813DH	13/16"	-	16,60
1485050	CE08M21DH	-	21	16,60
1485051	CE08M22DH	-	22	16,60
1485052	CE0814DH	7/8"	-	16,60

Ref.	Código	Entrecaras "	Entrecaras mm	€ / u.
1485060	CE08M23DH	-	23	16,64
1485061	CE0815DH	15/16"	-	17,94
1485062	CE08M24DH	-	24	17,94
1485063	CE08M25DH	-	25	17,94
1485064	CE0816DH	1"	-	18,38
1485065	CE08M26DH	-	26	18,92
1485066	CE0817M27DH	1.1/16"	27	23,86
1485067	CE08M28DH	28	-	23,86
1485068	CE0818DH	1.1/8"	-	26,87
1485069	CE08M29DH	-	29	26,87
1485070	CE0819M30DH	1.3/16"	30	24,90
1485071	CE08M31DH	-	31	26,87
1485072	CE0820DH	1.1/4"	-	26,87
1485073	CE08M32DH	-	32	24,90
1485074	CE08M33DH	-	33	32,54
1485075	CE0821DH	1.5/16"	-	32,54
1485076	CE08M34DH	-	34	38,97
1485077	CE0822M35DH	1.3/8"	35	38,97
1485078	CE08M36DH	-	36	38,97
1485079	CE0823DH	1.7/16"	-	41,94
1485080	CE08M37DH	-	37	41,94
1485081	CE0824M38DH	1.1/2"	38	42,83



K7806 - Vaso de impacto 1/2", largo



Acero aleado especial, tratado pavonadas.

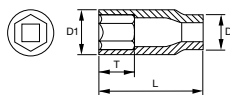

Ref.	Código	Entrecaras mm	D1 mm	D2 mm	L mm	Muelle de fijación	€ / u.
1221000	K7806M-10	10	17.5	25	80	K560F-4	12,54
1221001	K7806M-11	11	18	25	80	K560F-4	12,54
1221002	K7806M-12	12	19.3	25	80	K560F-4	12,54
1221003	K7806M-13	13	20.9	25	80	K560F-4	12,54
1221004	K7806M-14	14	22.3	25	80	K560F-4	12,54
1221005	K7806M-16	16	24.4	30	80	K560F-5	12,68
1221006	K7806M-17	17	25.2	30	80	K560F-5	12,68
1221007	K7806M-18	18	26.8	30	80	K560F-5	12,72

Ref.	Código	Entrecaras mm	D1 mm	D2 mm	L mm	Muelle de fijación	€ / u.
1221008	K7806M-19	19	28.5	30	80	K560F-5	12,72
1221009	K7806M-21	21	31.4	30	83	K560F-5	12,72
1221010	K7806M-22	22	32.7	30	89	K560F-5	12,72
1221011	K7806M-23	23	34	30	89	K560F-5	13,31
1221012	K7806M-24	24	34.9	30	89	K560F-5	13,33
1221013	K7806M-27	27	38.9	30	89	K560F-5	15,32
1221014	K7806M-30	30	42.8	30	89	K560F-5	17,32

K7801Z - Vaso de impacto 1/2", largo, pulgadas



Acero aleado especial, tratado pavonadas.

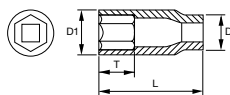

Ref.	Código	Entrecaras"	D1 mm	D2 mm	L mm	Muelle de fijación	T mm	€ / u.
1273100	K7801Z-3/8	3/8	17	25	78	K560F-4	12	13,78
1273101	K7801Z-7/16	7/16	18.5	25	78	K560F-4	13	13,78
1273102	K7801Z-1/2	1/2	20.5	25	78	K560F-4	14	13,78
1273103	K7801Z-9/16	9/16	23	25	78	K560F-4	14	13,78
1273104	K7801Z-5/8	5/8	24.5	30	78	K560F-4	16	13,94
1273105	K7801Z-11/16	11/16	27	30	78	K560F-5	17	13,94
1273106	K7801Z-3/4	3/4	28	30	78	K560F-5	20	13,98
1273107	K7801Z-13/16	13/16	30	30	78	K560F-5	22	13,98
1273108	K7801Z-7/8	7/8	31.8	30	78	K560F-5	22	13,98

Ref.	Código	Entrecaras"	D1 mm	D2 mm	L mm	Muelle de fijación	T mm	€ / u.
1273109	K7801Z-15/16	15/16	33.8	30	78	K560F-5	24	14,43
1273110	K7801Z-1	1	35.8	30	78	K560F-5	27	15,77
1273111	K7801Z-1.1/16	1.1/16	37.8	30	78	K560F-5	27	16,84
1273112	K7801Z-1.1/8	1.1/8	39.8	30	78	K560F-5	27	19,06
1273113	K7801Z-1.1/4	1.1/4	43.8	30	78	K560F-5	27	29,48
1273114	K7801Z-1.5/16	1.5/16	44.8	30	78	K560F-5	32	34,24
1273115	K7801Z-1.3/8	1.3/8	47.8	30	78	K560F-5	32	34,24
1273116	K7801Z-1.7/16	1.7/16	49.8	30	78	K560F-5	32	34,24
1273117	K7801Z-1.1/2	1.1/2	49.8	30	78	K560F-5	32	39,35

7993S - Vaso de impacto 1/2", con punta hexagonal

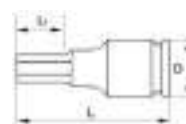

Ref.	Código	Hexágono exterior mm	d mm	L1 mm	L mm	€ / u.
1221500	7993S0050	5	25	8	44	44,05
1221501	7993S0060	6	25	9	44	40,23
1221502	7993S0080	8	25	12	44	40,23
1221503	7993S0100	10	25	16	47	42,69

Ref.	Código	Hexágono exterior mm	d mm	L1 mm	L mm	€ / u.
1221504	7993S0120	12	30	18	50	42,69
1221505	7993S0140	14	30	21	50	44,05
1221506	7993S0170	17	30	26	50	44,05
1221507	7993S0190	19	30	26	50	44,05

K7801TORX-E - Vaso de impacto 1/2", TORX®



Acero aleado especial, tratado pavonadas.

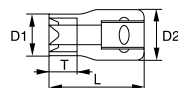

Ref.	Código	Punta torx	Tornillo	D1 mm	D2 mm	L mm	€ / u.
1221100	K7801TORX-E10	E-10	M6+M8	13.5	25	38	13,63
1221101	K7801TORX-E12	E-12	M8+M10	15.5	25	38	13,63
1221102	K7801TORX-E14	E-14	M10+M12	17.6	25	38	13,63
1221103	K7801TORX-E16	E-16	-	19.6	25	38	13,63

Ref.	Código	Punta torx	Tornillo	D1 mm	D2 mm	L mm	€ / u.
1221104	K7801TORX-E18	E-18	M12+M14	21.7	30	38	13,63
1221105	K7801TORX-E20	E-20	M14+M16	23.8	30	38	14,77
1221106	K7801TORX-E24	E-24	M18+M20	28.3	30	38	14,77

7994S - Vaso de impacto 1/2", con punta TORX®



Ref.	Código	Punta torx	d mm	L1 mm	L mm	€ / u.
1221550	7994S0300	T-30	25	30	55	23,07
1221551	7994S0400	T-40	25	30	55	23,07
1221552	7994S0450	T-45	25	30	55	23,07
1221553	7994S0500	T-50	25	30	55	23,07
1221554	7994S0550	T-55	25	30	55	24,40
1221555	7994S0600	T-60	25	30	55	26,99

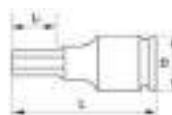

K8160D - Extensión impacto 1/2"



Acero aleado especial, tratado pavonadas.

Ref.	Código	Cuadrado interior**	Cuadrado Exterior	Longitud mm	Muelle de fijación	Ø mm	€ / u.
1221200	K8160D-1	1/2	1/2	75	K560F-4	25	14,10
1221201	K8160D-2	1/2	1/2	125	K560F-4	25	17,36
1221202	K8160D-3	1/2	1/2	250	K560F-4	25	27,51

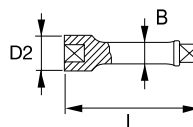

K8167S - Articulación impacto 1/2"



Acero aleado especial, tratado pavonadas. Ángulo máximo 30°. Con pasador accionado por muelle.

Ref.	Código	Cuadrado interior**	Cuadrado Exterior	Longitud mm	Muelle de fijación	Ø mm	€ / u.
1221300	K8167S	1/2	1/2	62	K560F-5	34	34,64

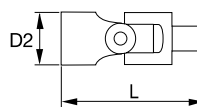

K7764D - Aumentador y reductor



Acero aleado especial, tratado. Pavonados. Con agujero pasante.

Ref.	Código	Cuadrado interior**	Cuadrado Exterior	Longitud mm	Muelle de fijación	Ø mm	€ / u.
1221400	K7764D	3/8	1/2	35	K560F-4	25	24,02
1221401	K8964D	3/4	1/2	45	K560F-4	25	16,59

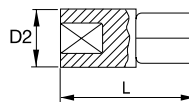



K8901M - Vaso de impacto 3/4"

DIN 3129 - ISO 2725. Acero aleado especial, tratado pavonadas.

Ref.	Código	Entrecaras mm	D1 mm	D2 mm	L mm	Muelle de fijación	€/ u.
1221600	K8901M-17	17	30	44	51	K560F-6	23,17
1221601	K8901M-18	18	31	44	51	K560F-6	23,15
1221602	K8901M-19	19	32,5	44	51	K560F-6	23,17
1221603	K8901M-21	21	35	44	51	K560F-6	23,26
1221604	K8901M-22	22	36	44	51	K560F-6	23,26
1221605	K8901M-23	23	37,5	44	51	K560F-6	23,26
1221606	K8901M-24	24	38,5	44	51	K560F-6	24,15
1221607	K8901M-27	27	42,5	44	53	K560F-6	25,49
1221608	K8901M-28	28	44	44	53	K560F-6	26,66
1221609	K8901M-29	29	45	44	53	K560F-6	29,88
1221610	K8901M-30	30	46	44	53	K560F-6	32,66
1221611	K8901M-32	32	48,5	44	57	K560F-6	32,56
1221612	K8901M-33	33	50	44	57	K560F-6	33,39
1221613	K8901M-34	34	51	44	57	K560F-6	33,36
1221614	K8901M-36	36	53,5	44	57	K560F-6	35,18
1221615	K8901M-38	38	56	44	57	K560F-6	36,73
1221616	K8901M-41	41	60	44	58	K560F-6	43,67
1221617	K8901M-46	46	66	44	62	K560F-6	44,35
1221618	K8901M-50	50	71	44	68	K560F-7	72,67
1221619	K8901M-55	55	77,5	54	72	K560F-7	87,58
1221620	K8901M-60	60	83,5	54	72	K560F-7	102,80

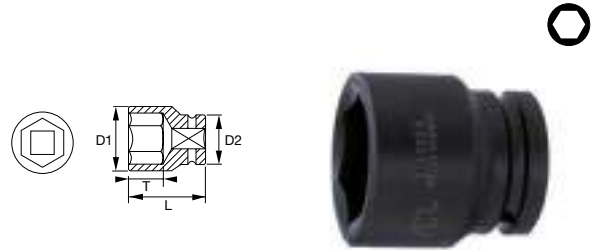

16405 - Vaso de impacto 3/4", bihexagonal

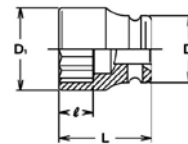

Ref.	Código	Entrecaras mm	D1 mm	D2 mm	L mm	€/ u.
1200780	8K16405M17	17	30	44	50	30,14
1200781	8K16405M18	18	31,3	44	50	30,14
1200782	8K16405M19	19	32,5	44	50	30,14
1200783	8K16405M20	20	33,8	44	50	32,63
1200784	8K16405M21	21	35	44	50	32,63
1200785	8K16405M22	22	36,3	44	50	32,63
1200786	8K16405M23	23	37,5	44	50	32,63
1200787	8K16405M24	24	38,8	44	50	32,63
1200788	8K16405M25	25	40	44	50	34,54
1200789	8K16405M26	26	41,3	44	50	34,54
1200790	8K16405M27	27	42,5	44	50	35,36
1200791	8K16405M28	28	43,8	44	50	35,36

Ref.	Código	Entrecaras mm	D1 mm	D2 mm	L mm	€/ u.
1200792	8K16405M29	29	45	44	53	35,36
1200793	8K16405M30	30	46,3	44	53	35,36
1200794	8K16405M33	33	50	44	55	46,73
1200795	8K16405M34	34	51,3	44	55	46,73
1200796	8K16405M36	36	53,8	44	55	46,73
1200797	8K16405M38	38	56,3	44	57	49,34
1200798	8K16405M41	41	60	44	57	61,45
1200799	8K16405M42	42	61,3	44	57	61,44
1200800	8K16405M46	46	66,3	44	62	75,16
1200801	8K16405M50	50	71,3	54	62	87,43
1200802	8K16405M52	52	73,8	54	62	95,60
1200803	8K16405M55	55	77,5	54	62	110,80

K8906M - Vaso de impacto 3/4", largo



Acero aleado especial, tratado pavonadas. Con Perfil Dynamic Drive.

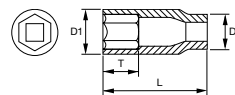

Ref.	Código	Entrecaras mm	D1 mm	D2 mm	L mm	Muelle de fijación	€/ u.
1221800	K8906M-17	17	30	44	100	K560F-6	42,73
1221801	K8906M-19	19	32,5	44	100	K560F-6	43,71
1221802	K8906M-21	21	36,5	44	100	K560F-6	44,43
1221803	K8906M-22	22	36,5	44	100	K560F-6	44,43
1221804	K8906M-24	24	39	44	100	K560F-6	45,14
1221805	K8906M-27	27	43	44	100	K560F-6	46,84

Ref.	Código	Entrecaras mm	D1 mm	D2 mm	L mm	Muelle de fijación	€/ u.
1221806	K8906M-30	30	46	44	100	K560F-6	47,83
1221807	K8906M-32	32	49	44	100	K560F-6	50,94
1221808	K8906M-33	33	50,8	44	100	K560F-6	51,67
1221809	K8906M-34	34	50,8	44	100	K560F-6	54,42
1221810	K8906M-36	36	54	44	100	K560F-6	56,30
1221811	K8906M-41	41	60,5	44	100	K560F-6	58,73

1640 - Vaso de impacto 3/4", pulgadas



01

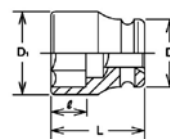

Ref.	Código	D1 mm	D2 mm	Hexágono exterior "	Longitud mm	l	ε / u.
1200710	8K16400M17	30	44	11/16	50	12	19,26
1200711	8K16400M18	31,3	44	-	50	13	19,26
1200712	8K16400M19	32,5	44	3/4	50	13	19,69
1200713	8K16400M20	33,8	44	25/32	50	14	20,83
1200714	8K16400M21	35	44	13/16	50	15	19,34
1200715	8K16400M22	36,3	44	7/8	50	15	19,34
1200716	8K16400M23	37,5	44	-	50	16	19,34
1200717	8K16400M24	38,8	44	15/16	50	16	19,34
1200718	8K16400M25	40	44	31/32	50	16	20,45
1200719	8K16400M26	41,3	44	1	50	16	20,45
1200720	8K16400M27	42,5	44	1-1/16	50	16	21,02
1200721	8K16400M28	43,8	44	-	50	16	19,69
1200722	8K16400M29	45	44	1-1/8	53	18	19,69
1200723	8K16400M30	46,3	44	1-3/16	53	18	19,69
1200724	8K16400M31	47,5	44	-	53	18	23,09
1200725	8K16400M32	46,8	44	1-1/4	53	19	23,09
1200726	8K16400M33	50	44	1-5/16	55	20	25,89
1200727	8K16400M34	51,3	44	-	55	20	26,70
1200728	8K16400M35	52,5	44	1-3/8	55	20	28,52
1200729	8K16400M36	53,8	44	-	55	20	26,35
1200730	8K16400M37	55	44	1-7/16	55	20	29,85
1200731	8K16400M38	56,3	44	1-1/2	57	20	27,87
1200732	8K16400M39	57,5	44	-	57	20	36,16
1200733	8K16400M40	58,8	44	1-9/16	57	20	33,54
1200734	8K16400M41	60	44	1-5/8	57	22	32,20
1200735	8K16400M42	61,3	44	-	57	22	35,34
1200736	8K16400M43	62,5	44	1-11/16	62	23	35,34
1200737	8K16400M44	63,8	44	1-3/4	62	23	38,26
1200738	8K16400M45	65	44	-	62	23	43,30
1200739	8K16400M46	66,3	44	1-13/16	62	23	41,45
1200740	8K16400M47	67,5	54	-	62	23	43,30
1200741	8K16400M48	68,8	54	1-7/8	62	23	49,43
1200742	8K16400M49	70	54	1-15/16	62	23	49,43
1200743	8K16400M50	71,3	54	-	62	30	47,28
1200744	8K16400M52	73,8	54	-	62	29	52,54

Ref.	Código	D1 mm	D2 mm	Hexágono exterior "	Longitud mm	l	ε / u.
1200745	8K16400M54	76,3	54	2-1/8	62	29	60,92
1200746	8K16400M55	77,5	54	2-3/16	62	29	60,63
1200747	8K16400M56	78,8	54	-	62	29	64,94
1200748	8K16400M57	80	54	2-1/4	65	32	65,30
1200749	8K16400M58	81,3	54	2-5/16	65	31	66,49
1200750	8K16400M59	82,5	54	-	65	31	66,49
1200751	8K16400M60	83,8	54	2-3/8	65	31	75,01
1200752	8K16400A11/16	30	44	11/16	50	12	19,26
1200753	8K16400A3/4	31,3	44	-	50	13	19,69
1200754	8K16400A13/16	32,5	44	3/4	50	13	20,83
1200755	8K16400A7/8	33,8	44	25/32	50	14	20,83
1200756	8K16400A15/16	35	44	13/16	50	15	19,34
1200757	8K16400A1	36,3	44	7/8	50	15	20,45
1200758	8K16400A11/16	37,5	44	-	50	16	21,02
1200759	8K16400A11/8	38,8	44	15/16	50	16	21,02
1200760	8K16400A13/16	40	44	31/32	50	16	19,69
1200761	8K16400A11/4	41,3	44	1	50	16	23,09
1200762	8K16400A15/16	42,5	44	1-1/16	50	16	27,70
1200763	8K16400A13/8	43,8	44	-	50	16	28,52
1200764	8K16400A17/16	45	44	1-1/8	53	18	28,52
1200765	8K16400A11/2	46,3	44	1-3/16	53	18	27,87
1200766	8K16400A19/16	47,5	44	-	53	18	33,58
1200767	8K16400A15/8	46,8	44	1-1/4	53	19	32,20
1200768	8K16400A111/16	50	44	1-5/16	55	20	35,34
1200769	8K16400A13/4	51,3	44	-	55	20	38,26
1200770	8K16400A113/16	52,5	44	1-3/8	55	20	41,45
1200771	8K16400A17/8	53,8	44	-	55	20	43,30
1200772	8K16400A115/16	55	44	1-7/16	55	20	49,43
1200773	8K16400A2	56,3	44	1-1/2	57	20	60,29
1200774	8K16400A21/8	57,5	44	-	57	20	60,92
1200775	8K16400A23/16	58,8	44	1-9/16	57	20	63,77
1200776	8K16400A21/4	60	44	1-5/8	57	22	65,29
1200777	8K16400A25/16	61,3	44	-	57	22	66,49
1200778	8K16400A23/8	62,5	44	1-11/16	62	23	87,94

Vaso de impacto 3/4", largo, pared delgada



Los productos de Ozat se fabrican de acuerdo con las normas ANSI B107, DIN 3121, 3129 e ISO 2725, con tecnología de mecanizado electroquímico, único en su género, en acero aleado al Cromo Molybdeno 42 Cr Mo4 de alta calidad, para obtener un alto grado de dureza y resistencia. Los vasos de impacto de Ozat están diseñados (bajo sistema "Less-Stress" TM) con la más alta tecnología, para cargas de trabajo continuadas, que permite tener holgura en la esquina y refuerzo especial en el punto de carga del flanco de la turca o tornillo.



Ref.	Código	Entrecaras "	Entrecaras mm	ε / u.
1485085	CEI2M17LT	-	17	40,60
1485086	CEI211LT	11/16"	-	40,61
1485087	CEI2M18LT	-	18	40,60
1485088	CEI212M19LT	3/4"	19	40,61
1485089	CEI2M20LT	-	20	41,29
1485090	CEI213LT	13/16"	-	41,29
1485091	CEI2M21LT	-	21	41,38
1485092	CEI2M22LT	-	22	41,38
1485093	CEI214LT	7/8"	-	41,38
1485094	CEI2M23LT	-	23	41,38
1485095	CEI215LT	15/16"	-	41,38
1485096	CEI2M24LT	-	24	41,38
1485097	CEI2M25LT	-	25	44,36
1485098	CEI216LT	1"	-	44,36
1485099	CEI2M26LT	-	26	44,36
1485100	CEI217M27LT	1.1/16"	27	44,36
1485101	CEI2M28LT	-	28	54,71
1485102	CEI218LT	1.1/8"	-	54,71
1485103	CEI2M29LT	-	29	54,71
1485104	CEI219M30LT	1.3/16"	30	54,71
1485105	CEI2M31LT	-	31	56,61

Ref.	Código	Entrecaras "	Entrecaras mm	ε / u.
1485110	CEI220LT	1.1/4"	-	56,61
1485111	CEI2M32LT	-	32	56,61
1485112	CEI2M33LT	-	33	72,44
1485113	CEI221LT	1.5/16"	-	72,44
1485114	CEI2M34LT	-	34	72,44
1485115	CEI222M35LT	1.3/8"	35	72,44
1485116	CEI2M36LT	-	36	72,44
1485117	CEI223LT	1.7/16"	-	72,44
1485118	CEI2M37LT	-	37	77,79
1485119	CEI224M38LT	1.1/2"	38	77,79
1485120	CEI2M39LT	-	39	82,98
1485121	CEI225LT	1.9/16"	-	82,98
1485122	CEI2M40LT	-	40	82,98
1485123	CEI226M41LT	1.5/8"	41	85,77
1485124	CEI2M42LT	-	42	96,43
1485125	CEI227M43LT	1.11/16"	43	96,43
1485126	CEI2M44LT	-	44	122,52
1485127	CEI228LT	1.3/4"	-	122,52
1485128	CEI2M45LT	-	45	122,52
1485129	CEI229M46LT	1.13/16"	46	117,21



K8901M - Vaso de impacto 3/4", pulgadas



Ref.	Código	Entrecaras "	D1 mm	D2 mm	L mm	Muelle de fijación	€ / u.
1221701	K8901Z-3/4	3/4	33	44	50	K560F-6	27,79
1221702	K8901Z-13/16	13/16	35	44	50	K560F-6	27,79
1221703	K8901Z-7/8	7/8	37	44	50	K560F-6	27,79
1221704	K8901Z-15/16	15/16	39	44	50	K560F-6	27,79
1221705	K8901Z-1	1	41	44	50	K560F-6	29,07
1221706	K8901Z-1.1/16	1.1/16	43	44	50	K560F-6	29,07
1221707	K8901Z-1.1/8	1.1/8	45	44	50	K560F-6	29,07
1221708	K8901Z-1.1/4	1.1/4	49	44	50	K560F-6	29,77
1221709	K8901Z-1.5/16	1.5/16	50	44	53	K560F-6	29,77
1221710	K8901Z-1.3/8	1.3/8	53.5	44	55	K560F-6	30,56
1221711	K8901Z-1.7/16	1.7/16	53.5	44	55	K560F-6	30,56
1221712	K8901Z-1.1/2	1.1/2	55	44	56	K560F-6	39,18
1221713	K8901Z-1.5/8	1.5/8	61	44	58	K560F-6	43,20
1221714	K8901Z-1.3/4	1.3/4	65	44	63	K560F-6	51,41
1221715	K8901Z-1.15/16	1.15/16	70	44	68	K560F-6	65,79
1221716	K8901Z-2	2	71	44	68	K560F-6	65,79
1221717	K8901Z-2.1/16	2.1/16	73	44	71	K560F-6	74,57
1221718	K8901Z-2.3/16	2.3/16	78	54	71	K560F-7	82,60
1221719	K8901Z-2.1/4	2.1/4	80	54	73	K560F-7	86,61
1221720	K8901Z-2.3/8	2.3/8	83	54	73	K560F-7	93,07

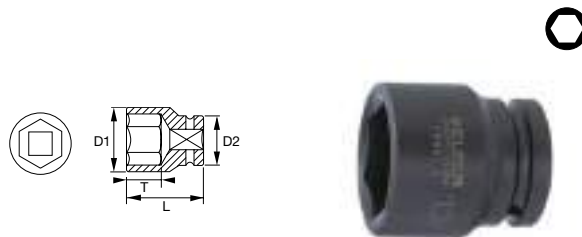

Vaso de impacto 3/4", cuatro caras. "BUD WHEEL"



Los productos de Ozat se fabrican de acuerdo con las normas ANSI B107, DIN 3121, 3129 e ISO 2725, con tecnología de mecanizado electroquímico, único en su género, en acero aleado al Cromo Molybdeno 42 Cr Mo4 de alta calidad, para obtener un alto grado de dureza y resistencia. Los vasos de impacto de Ozat están diseñados (bajo sistema "Less-Stress" TM) con la más alta tecnología, para cargas de trabajo continuadas, que permite tener holgura en la esquina y refuerzo especial en el punto de carga del flanco de la turca o tornillo.

Ref.	Código	Entrecaras mm	€ / u.
1485135	CE12M17B	17	49,94
1485136	CE12M21B	21	97,09



K8960F - Extensión impacto 3/4"



Acero aleado especial, tratado pavonadas.

Ref.	Código	Cuadradillo interior "	Cuadrado Exterior	Longitud mm	Muelle de fijación	Ø mm	€ / u.
1221900	K8960F-2	3/4	3/4	175	K560F-6	44	45,94
1221901	K8960F-3	3/4	3/4	250	K560F-6	44	55,15



K8967S - Articulación impacto 3/4"



Ángulo máximo 35°. Con agujero pasante.

Ref.	Código	Cuadradillo interior "	Cuadrado Exterior	Longitud mm	Muelle de fijación	Ø mm	€ / u.
1222000	K8967S	3/4	3/4	98	K560F-6	48	92,02



K8164F - Aumentador y reductor 3/4"



Acero aleado especial, tratado pavonados.

Ref.	Código	Cuadradillo interior "	Cuadrado Exterior	Longitud mm	Muelle de fijación	Ø mm	€ / u.
1221950	K8164F	1/2	3/4	56	K560F-6	44	33,68
1221951	K9564F	1	3/4	63	K560F-6	44	37,34

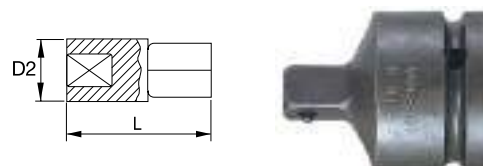

7993T - Vaso de impacto 3/4" con punta hexagonal



UNE 16503 · ISO 1174 · DIN 3121 Acero aleado especial, tratado pavonadas.

Ref.	Código	Entrecaras mm	d mm	L1 mm	L mm	€/ u.
1222200	7993T0120	12	38	18	67	53,60
1222201	7993T0140	14	38	21	67	58,91
1222202	7993T0170	17	38	26	67	58,91
1222203	7993T0190	19	44	26	67	58,91
1222204	7993T0220	22	44	26	71	70,48
1222205	7993T0240	24	44	26	71	70,48

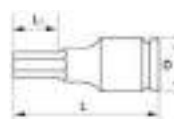

K9501 - Vaso de impacto 1"



DIN 3129 · ISO 2725. Acero aleado especial, tratado pavonadas.

Ref.	Código	Entrecaras mm	L mm	D1 mm	D2 mm	Muelle de fijación	€/ u.
1222300	K9501M-22	22	58	39	54	K560F-7	43,37
1222301	K9501M-24	24	58	42	54	K560F-7	43,37
1222302	K9501M-27	27	59	45.5	54	K560F-7	44,73
1222303	K9501M-30	30	64	49	54	K560F-7	45,96
1222304	K9501M-32	32	64	52	54	K560F-7	48,26
1222305	K9501M-33	33	62	53	54	K560F-7	49,64
1222306	K9501M-34	34	62	54	54	K560F-7	51,18
1222307	K9501M-36	36	66	57	54	K560F-7	51,18
1222308	K9501M-38	38	67	60	54	K560F-7	51,58
1222309	K9501M-41	41	69	63	54	K560F-7	58,12
1222310	K9501M-42	42	69	64	54	K560F-7	68,47
1222311	K9501M-46	46	75	69.5	54	K560F-7	71,48
1222312	K9501M-50	50	81	74	54	K560F-7	79,66
1222313	K9501M-55	55	86	79.5	54	K560F-7	91,20
1222314	K9501M-60	60	90	86	54	K560F-7	111,09
1222315	K9501M-65	65	94	90.5	54	K560F-7	132,93
1222316	K9501M-70	70	98	98	54	K560F-7	151,57
1222317	K9501M-75	75	98	100	86	K560F-8	158,49
1222318	K9501M-80	80	99	105	86	K560F-8	166,83

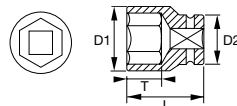

18400M - Vaso de impacto 1"



Ref.	Código	Entrecaras mm	D1 mm	D2 mm	L mm	€/ u.
1520017	8K18400M17	17	32,8	54	57	38,76
1520019	8K18400M19	19	35,3	54	57	31,65
1520021	8K18400M21	21	37,8	54	57	31,65
1520022	8K18400M22	22	39	54	57	31,65
1520023	8K18400M23	23	40,3	54	57	31,65
1520024	8K18400M24	24	41,5	54	57	33,05
1520025	8K18400M25	25	42,8	54	57	33,05
1520026	8K18400M26	26	44	54	57	33,05
1520027	8K18400M27	27	45,3	54	57	33,05
1520028	8K18400M28	28	46,5	54	57	33,05
1520029	8K18400M29	29	47,8	54	57	33,05
1520030	8K18400M30	30	49	54	62	33,05
1520031	8K18400M31	31	50,3	54	62	33,05
1520032	8K18400M32	32	51,5	54	62	33,05
1520033	8K18400M33	33	52,8	54	62	33,05
1520034	8K18400M34	34	54	54	62	36,74
1520035	8K18400M35	35	55,3	54	62	36,74
1520036	8K18400M36	36	56,5	54	62	36,74
1520037	8K18400M37	37	57,8	54	62	36,74
1520038	8K18400M38	38	59	54	66	36,74
1520040	8K18400M40	40	61,5	54	66	43,55
1520041	8K18400M41	41	62,8	54	66	43,55
1520042	8K18400M42	42	64	54	66	43,55
1520043	8K18400M43	43	65,3	54	68	47,37

Ref.	Código	Entrecaras mm	D1 mm	D2 mm	L mm	€/ u.
1520044	8K18400M44	44	66,5	54	68	47,37
1520045	8K18400M45	45	67,8	54	68	49,89
1520046	8K18400M46	46	69	54	70	49,89
1520047	8K18400M47	47	70,3	54	70	51,63
1520048	8K18400M48	48	71,5	54	70	53,13
1520050	8K18400M50	50	74	54	70	56,31
1520052	8K18400M52	52	76,5	54	75	69,70
1520054	8K18400M54	54	79	54	75	73,83
1520055	8K18400M55	55	80,3	54	75	73,83
1520056	8K18400M56	56	81,5	54	75	77,88
1520058	8K18400M58	58	84	54	75	80,55
1520060	8K18400M60	60	86,5	54	75	85,48
1520062	8K18400M62	62	89	54	75	106,68
1520063	8K18400M63	63	90,3	54	75	106,68
1520065	8K18400M65	65	92,8	54	75	109,56
1520067	8K18400M67	67	95,3	54	75	122,35
1520068	8K18400M68	68	96,5	54	75	122,35
1520070	8K18400M70	70	99	54	75	123,19
1520075	8K18400M75	75	105,3	86	80	157,68
1520080	8K18400M80	80	115,5	86	85	183,32
1520085	8K18400M85	85	117,8	86	90	242,88
1520090	8K18400M90	90	124	86	95	248,52
1520095	8K18400M95	95	130,3	86	100	326,42





K9506 - Vaso de impacto 1", largo

Acero aleado especial, tratado pavonadas.

Ref.	Código	Entrecaras mm	L mm	D1 mm	D2 mm	Muelle de fijación	€ / u.
1222500	K9506M-22	22	110	40	54	K560F-7	72,10
1222501	K9506M-24	24	110	42	54	K560F-7	72,10
1222502	K9506M-27	27	110	46	54	K560F-7	72,10
1222503	K9506M-30	30	110	49,5	54	K560F-7	72,81
1222504	K9506M-32	32	110	52	54	K560F-7	74,83
1222505	K9506M-33	33	110	53	54	K560F-7	75,85
1222506	K9506M-34	34	110	53,5	54	K560F-7	77,86
1222507	K9506M-36	36	110	57	54	K560F-7	77,86
1222508	K9506M-38	38	110	59,5	54	K560F-7	79,33
1222509	K9506M-41	41	110	63	54	K560F-7	87,57
1222510	K9506M-46	46	110	69,5	54	K560F-7	95,25
1222511	K9506M-50	50	110	74,5	54	K560F-7	115,77
1222512	K9506M-55	55	110	81	54	K560F-7	140,96
1222513	K9506M-60	60	110	87,5	54	K560F-7	172,26

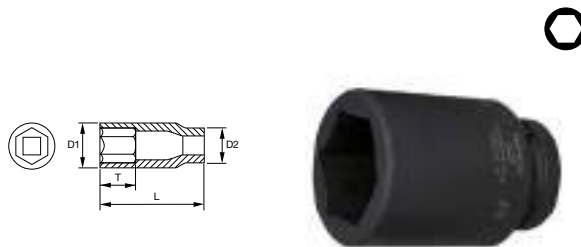

K9501 - Vaso de impacto 1", pulgadas



Ref.	Código	Entrecaras "	L mm	D1 mm	D2 mm	Muelle de fijación	€ / u.
1222350	K9501Z-1	1	59	43	54	K560F-7	43,82
1222351	K9501Z-1.1/16	1.1/16	60	44,5	54	K560F-7	43,82
1222352	K9501Z-1.1/8	1.1/8	62	46	54	K560F-7	43,82
1222353	K9501Z-1.3/16	1.3/16	62	49	54	K560F-7	43,82
1222354	K9501Z-1.1/4	1.1/4	62	52	54	K560F-7	43,82
1222355	K9501Z-1.5/16	1.5/16	63	54	54	K560F-7	48,74
1222356	K9501Z-1.3/8	1.3/8	66	55	54	K560F-7	54,56
1222357	K9501Z-1.7/16	1.7/16	66	57	54	K560F-7	54,56
1222358	K9501Z-1.1/2	1.1/2	67	60	54	K560F-7	55,91
1222359	K9501Z-1.9/16	1.9/16	66	61	54	K560F-7	55,91
1222360	K9501Z-1.5/8	1.5/8	69	63	54	K560F-7	59,82
1222361	K9501Z-1.11/16	1.11/16	70	65	54	K560F-7	68,79
1222362	K9501Z-1.3/4	1.3/4	70	67,5	60,3	K560F-7	68,79
1222363	K9501Z-1.13/16	1.13/16	75	69,5	54	K560F-7	74,85
1222364	K9501Z-1.7/8	1.7/8	78	70,5	54	K560F-7	74,85
1222365	K9501Z-1.15/16	1.15/16	58	40,5	60,3	K560F-7	77,53
1222366	K9501Z-2	2	76	74	60,3	K560F-7	87,70
1222367	K9501Z-2.1/8	2.1/8	80	79	60,3	K560F-7	98,54
1222368	K9501Z-2.3/16	2.3/16	84	80	60,3	K560F-7	98,54
1222369	K9501Z-2.1/4	2.1/4	84	82,5	60,3	K560F-7	107,05
1222370	K9501Z-2.5/16	2.5/16	84	84	60,3	K560F-7	107,05
1222371	K9501Z-2.9/16	2.9/16	92	92,5	60,3	K560F-7	147,64
1222372	K9501Z-2.3/4	2.3/4	96	99	60,3	K560F-7	155,07

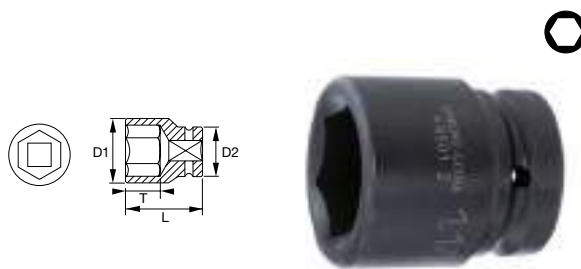

K9506 - Vaso de impacto 1", largo, pulgadas



Acero aleado especial, tratado pavonadas.



Ref.	Código	Entrecaras "	L mm	D1 mm	D2 mm	Muelle de fijación	T mm	€ / u.
1222550	K9506Z-1	1	108	42,5	54	K560F-7	30	64,50
1222551	K9506Z-1.1/16	1.1/16	108	44,5	54	K560F-7	30	65,52
1222552	K9506Z-1.3/16	1.3/16	108	49	54	K560F-7	30	65,52
1222553	K9506Z-1.1/4	1.1/4	108	51,5	54	K560F-7	30	65,73
1222554	K9506Z-1.7/16	1.7/16	108	56,5	54	K560F-7	35	65,73
1222555	K9506Z-1.1/2	1.1/2	108	59	54	K560F-7	35	67,93
1222556	K9506Z-1.5/8	1.5/8	108	62,5	54	K560F-7	38	73,42
1222557	K9506Z-1.13/16	1.13/16	108	69	60,3	K560F-7	42	94,12
1222558	K9506Z-1.7/8	1.7/8	108	70	60,3	K560F-7	42	106,15

7993M™ - Vaso de impacto 1" con punta hexagonal



Acero templado.

Ref.	Código	Entrecaras mm	L mm	d mm	L1 mm	€/ u.
1222900	7993M0170	17	74	54	26	106,91
1222901	7993M0190	19	74	54	26	106,91
1222902	7993M0220	22	78	54	26	121,65
1222903	7993M0270	27	78	54	26	123,41

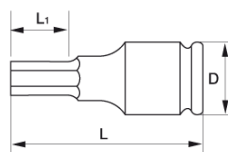

K9560G - Extensión impacto 1"



Acero aleado especial, tratado pavonadas. Con agujero pasante.

Ref.	Código	Cuadrado interior"	Cuadrado exterior"	Muelle de fijación	Longitud mm	Ø mm	€/ u.
1222600	K9560G-1	1	1	K560F-7	125	53	60,57
1222601	K9560G-2	1	1	K560F-7	175	53	66,26
1222602	K9560G-3	1	1	K560F-7	325	53	77,33
1222603	K9560G-4	1	1	K560F-7	300	54	66,49
1222604	K9560G-5	1	1	K560F-7	400	54	81,26

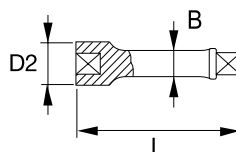

K9567S - Articulación universal 1"



Acero aleado especial, tratado pavonadas.

Ref.	Código	Cuadrado interior"	Cuadrado exterior"	Longitud mm	Muelle de fijación	Ø mm	€/ u.
1222700	K9567S	1	1	124	K560F-7	64	193,31

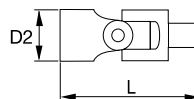

K8964G - Aumentador y reductor 1"



Acero aleado especial, tratado pavonadas.

Ref.	Código	Cuadrado interior"	Cuadrado exterior"	Longitud mm	Muelle de fijación	Ø mm	€/ u.
1222800	K8964G	3/4	1	75	K560F-7	54	35,75
1222801	K9895G	1.1/2	1	81	K560F-7	54	175,52

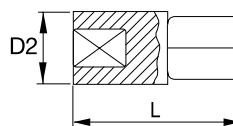

18866A- Adaptador de impacto 1"-1.1/2"



Ref.	Código	L mm	€/ u.
2400043	8K18866A-65	66.5	50,58
2400044	8K-18866A-200	200	76,65



K9598H - Adaptador de impacto 1.1/2" - 1"



Ref.	Código	Cuadradillo interior"	Cuadrado Exterior	Longitud mm	Muelle de fijación	Ø mm	€ / u.
1223100	K9598H	1.1/2	1	105	K560F-8	86	274,25

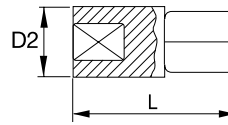

K9801M - Vaso de impacto 1.1/2"



DIN 3129, - ISO 2725. Con Perfil Dynamic Drive.

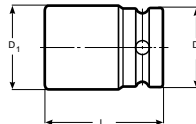

Ref.	Código	Entrecaras mm	L mm	D1 mm	D2 mm	Muelle de fijación	€ / u.
1223000	K9801M-46	46	80	76.3	86	K560F-8	202,35
1223001	K9801M-50	50	82	81.5	86	K560F-8	202,35
1223002	K9801M-55	55	82	87.4	86	K560F-8	214,30
1223003	K9801M-60	60	91	93.6	86	K560F-8	237,97
1223004	K9801M-65	65	95	99.8	86	K560F-8	258,86
1223005	K9801M-70	70	100	105.5	86	K560F-8	279,56
1223006	K9801M-75	75	105	112	86	K560F-8	303,32
1223007	K9801M-80	80	110	117.5	86	K560F-8	332,98
1223008	K9801M-85	85	120	124.8	86	K560F-8	382,60
1223009	K9801M-90	90	120	130	86	K560F-8	424,22
1223010	K9801M-95	95	126	136.5	127	K560F-9	501,30
1223011	K9801M-100	100	126	143.7	127	K560F-9	538,35

Ref.	Código	Entrecaras mm	L mm	D1 mm	D2 mm	Muelle de fijación	€ / u.
1223012	K9801M-105	105	130	147.6	127	K560F-9	582,87
1223013	K9801M-110	110	130	153.2	127	K560F-9	736,18
1223014	K9801M-115	115	140	158.8	127	K560F-9	776,42
1223015	K9801M-120	120	140	166.7	127	K560F-9	835,88
1223016	K9801M-125	125	165.1	170.1	82.6	K560F-8	862,83
1223017	K9801M-130	130	165.1	176	82.6	K560F-8	958,70
1223018	K9801M-135	135	171.5	181.9	82.6	K560F-8	1.054,56
1223019	K9801M-140	140	177.8	187.7	82.6	K560F-8	1.102,50
1223020	K9801M-145	145	184.2	193.7	82.6	K560F-8	1.214,35
1223021	K9801M-150	150	184.2	199.5	82.6	K560F-8	1.438,07
1223022	K9801M-155	155	190.5	205.5	82.6	K560F-8	1.629,79

Vaso de impacto 1.1/2". Punta hexagonal en 2 piezas



Los productos de Ozat se fabrican de acuerdo con las normas ANSI B107, DIN 3121, 3129 e ISO 2725, con tecnología de mecanizado electroquímico, único en su género, en acero aleado al Cromo Molybdeno 42 Cr Mo4 de alta calidad, para obtener un alto grado de dureza y resistencia. Los vasos de impacto de Ozat están diseñados (bajo sistema "Less-Stress" TM) con la más alta tecnología, para cargas de trabajo continuadas, que permite tener holgura en la esquina y refuerzo especial en el punto de carga del flanco de la turca o tornillo.



Ref.	Código	Entrecaras mm	€ / u.
1484955	CE24M22V	22	435,03
1484956	CE24M24V	24	446,26
1484957	CE24M27V	27	446,26
1484958	CE24M30V	30	452,17
1484959	CE24M32V	32	458,02
1484960	CE24M36V	36	458,02
1484961	CE24M38V	38	458,02
1484962	CE24M41V	41	464,39
1484963	CE24M46V	46	464,39
1484964	CE24M50V	50	513,26
1484965	CE24M55V	55	513,26

Ref.	Código	Entrecaras "	€ / u.
1484966	CE2416V	1	445,45
1484967	CE2418V	1.1/8	445,45
1484968	CE2420V	1.1/4	451,34
1484969	CE2422V	1.3/8	457,20
1484970	CE2424V	1.1/2	457,20
1484971	CE2426V	1.5/8	463,55
1484972	CE2428V	1.3/4	463,55
1484973	CE2429V	1.13/16	463,55
1484974	CE2430V	1.7/8	512,33
1484975	CE2432V	2	512,33
1484976	CE2434V	2.1/8	512,33

Extensión 1.1/2"



Ref.	Código	Cuadradillo interior"	Cuadrado Exterior"	Longitud mm	Muelle de fijación	Ø mm	€ / u.
1273200	K9860H-1	1.1/2	1.1/2	200	K560F-8	86	416,85
1273201	K9860H-2	1.1/2	1.1/2	300	K560F-8	86	459,82
1273202	K9860H-3	1.1/2	1.1/2	400	K560F-8	86	463,86

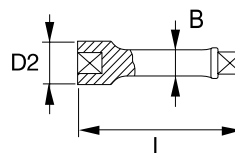

Articulación 1.1/2"



Ref.	Código	Cuadrado interior"	Cuadrado Exterior"	Longitud mm	Muelle de fijación	Ø mm	€ / u.
1273300	K9867S	1.1/2	1.1/2	154.2	K560F-8	88.9	654,43

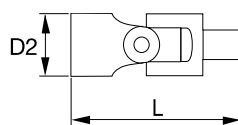

Vaso de impacto para tuercas estriadas (rodamientos)



Los productos de Ozat se fabrican de acuerdo con las normas ANSI B107, DIN 3121, 3129 e ISO 2725, con tecnología de mecanizado electroquímico, único en su género, en acero aleado al Cromo Molybdeno 42 Cr Mo4 de alta calidad, para obtener un alto grado de dureza y resistencia. Los vasos de impacto de Ozat están diseñados (bajo sistema "Less-Stress" TM) con la más alta tecnología, para cargas de trabajo continuadas, que permite tener holgura en la esquina y refuerzo especial en el punto de carga del flanco de la turca o tornillo.



Ref.	Código	Cuadrado interior"	Dimensión Ø mm	€ / u.
1484980	CEKM00	3/8	Para Ø18	120,84
1484981	CEKM01	3/8	Para Ø22	120,84
1484982	CEKM02	1/2	Para Ø25	120,84
1484983	CEKM03	1/2	Para Ø28	129,64
1484984	CEKM04	1/2	Para Ø32	129,64
1484985	CEKM05	1/2	Para Ø38	140,00
1484986	CEKM06	1/2	Para Ø45	155,40
1484987	CEKM07	1/2	Para Ø52	164,12
1484988	CEKM08	1/2	Para Ø58	172,67
1484989	CEKM09	3/4	Para Ø65	250,58
1484990	CEKM10	3/4	Para Ø70	259,14

Ref.	Código	Cuadrado interior"	Dimensión Ø mm	€ / u.
1484991	CEKM11	3/4	Para Ø75	267,80
1484992	CEKM12	3/4	Para Ø80	276,49
1484993	CEKM13	3/4	Para Ø85	285,14
1484994	CEKM14	1	Para Ø92	656,46
1484995	CEKM15	1	Para Ø98	656,46
1484996	CEKM16	1	Para Ø105	673,70
1484997	CEKM17	1	Para Ø110	804,13
1484998	CEKM18	1	Para Ø120	984,62
1484999	CEKM19	1	Para Ø125	1.148,80
1485000	CEKM20	1	Para Ø130	1.414,31

714 - Llave dinamométrica electromecánica



Ref.	Código	Longitud mm	ft.lb	Nm	Peso grs.	€ / u.
20006192	96500901	226	0,7 -7,5	1-10	370	1.727,00
20006193	96500902	226	1,5-15	2-20	380	1.689,00
20006194	96500904	252	3-30	4-40	420	1.781,00
20006195	96500906	393	4,5-45	6-60	810	1.781,00
20006196	96500910	466	7,4-75	10-100	1.085	1.848,00

Ref.	Código	Longitud mm	ft.lb	Nm	Peso grs.	€ / u.
20006197	96500920	547	15-150	20-200	1.361	1.887,00
20006198	96500940	687	30-300	40-400	1.765	2.032,00
20006199	96500965	890	48-480	65-650	3.222	2.415,00
20006200	96500980	1.158	60-600	80-800	4.572	2.626,00
20006191	96500100	1.343	74-750	100-1.000	4.990	2.811,00



730 - Llave dinamométrica



De disparo, Alojamiento para herramientas acoplables intercambiables. Bloqueo de seguridad QuickRelease (tño.5-65). Reglaje relámpago mediante palanca de bloqueo de fácil manejo en el mango (tño.5-65). Elemento de ajuste ergonómico y a prueba de resbalamiento con depresión para el dedo pulgar. Lupa integrada en la ventana de lectura. Mango bombeado optimizado para trabajar sin fatiga. Doble aviso de stop. Doble escala N-m/ft-lb, obien N-m/in-lb (tño.5-65). No es necesario poner a «0», dado que el elemento de medición sólo se somete a esfuerzo durante el proceso de apriete. Apriete hacia la izquierda invirtiendo las herramientas acoplables. Las sobrecargas que actúan después del disparo o las cargas en la dirección contraria a la del apriete -p.ej., al forzar tornillos agarrotados - no causan efecto alguno sobre el mecanismo de disparo, con lo cual se evita el deterioro del mismo. Si es necesario, reajuste sin desmontar la llave. Con certificado. Desviación de la indicación ±4%.



Ref.	Código	cuadrado	b mm	h mm	L mm	LF mm	tamaño	Rango	€/ u.
8001874	50184005	9x12	28	23	315	287,5	5	6-50 Nm	349,00
8001875	50184010	9x12	28	23	370	343	10	20-100 Nm	371,00
8001876	50184012	14x18	28	23	410	386	12	25-130 Nm	384,00
8001877	50184020	14x18	28	23	455	431,5	20	40-200 Nm	422,00
8001878	50184040	14x18	28	23	590	571,5	40	80-400 Nm	614,00
8001879	50184065	14x18	30,6	25,6	875	855	65	130-650 Nm	911,00
8001880	50184565	22x28	30,6	25,6	897	906	11/65	130-650 Nm	937,00
8001881	96503005	9X12	28	23	330	280,5	5	10-50 Nm	501,00
8001882	96503010	9X12	28	23	386	336	10	20-100 Nm	536,00
8001883	96503012	14X18	28	23	421	379	12	25-130 Nm	555,00
8001884	96503020	14X18	28	23	467	424,5	20	40-200 Nm	568,00
8001885	96503040	14X18	28	23	607	564,5	40	80-400 Nm	832,00
8001886	96503065	14X18	30,6	25,6	890	848	65	130-650 Nm	1.255,00
8001887	96503080	22X28	30,6	25,6	1.178	1.167	80	160-800 Nm	1.624,00
8001888	96503100	22X28	30,6	25,6	1.363	1.352	100	200-1.000 Nm	2.019,00

701 - Llave dinamométrica electrónica



Diseño muy ligero y compacto para pequeños pares de apriete a partir de 1 N-m. Unidades de medida: N-m, cN-m, ft-lb, in-lb. Medición independiente del punto de aplicación de la fuerza. De lectura directa -para un amplio rango dinamométrico de 1-20 N-m. Con el software SENSOMASTER 4, adicionalmente: Tarea de apriete ajustable, Evaluación del proceso de apriete mediante LEDs de colores, timbre y vibración, Intervalo de calibración ajustable, Capacidad de documentación. Entrega con pila. Si es necesario, reajuste sin desmontar la llave. Con certificado. Desviación de la indicación ± 4 %.



Ref.	Código	Cuadrado	b mm	h1 mm	h2 mm	L mm	tamaño	Rango	€/ u.
8001889	96504502	1/4"	22,6	26	10	210	2	1-20 Nm	642,00

IZO-DR - Llave dinamométrica electrónica de cabeza fija



Ref.	Código	Cuadradillo"	lb.ft	Nm	lb/in	€/ u.
1273450	IZO-DR-810	3/4	59.74-5974.2	81-810	716.9-7169	2.239,72

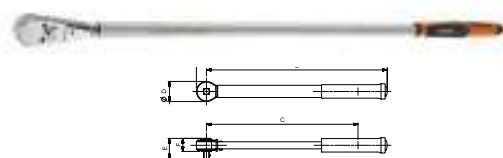

721 - Llave dinamométrica con carraca reversible



Standard MANOSKOP® 721. De disparo. Reglaje relámpago. Doble aviso de stop. Doble escala N-m/ft-lb. núm. No es necesario poner a "0", dado que el elemento de medición sólo se somete a esfuerzo durante el proceso de apriete. Protección de todas las piezas sensibles mediante la robusta carcasa de tubo de acero. Si es necesario, reajuste sin desmontar la llave. Con certificado. Desviación de la indicación ± 4%.



Ref.	Código	Cuadrado exterior"	b1 mm	b2 mm	h1 mm	h2 mm	LF mm	Rango	Tamaño	€ / u.
8000002	50204005	3/8	28	27,5	23	14,5	291	6-50 Nm	5	431,00
8000003	50204015	1/2	28	41	23	18	387	30-150 Nm	15	433,00
8000004	50204020	1/2	28	41	23	18	416,5	40-200 N-m	20	465,00
8000005	50204030	1/2	28	44	23	27,5	486	60-300 Nm	30	536,00

IZO-D - Llave dinamométrica electrónica de cabeza intercambiable



Ref.	Código	Cuadradillo "	lb.ft	Nm	lb/in	€ / u.
1273400	IZO-D-30	1/4	2.21-22.13	3-30	26.6-265.5	745,95
1273401	IZO-D-135	3/8	10-99.57	7-135	62-1195	745,95
1273402	IZO-D-200	1/2	14.75-147.50	20-200	177-1770	817,83
1273403	IZO-D-340	1/2	25.07-250.80	34-340	301-3009	942,40

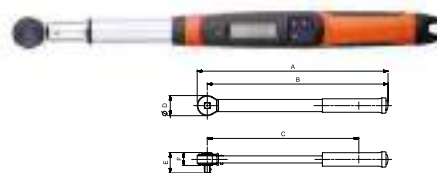

Comprobador para llaves dinamométricas



Robusto: La longevidad típica de STAHLWILLE está asegurada gracias a la protección óptica y acústica contra sobredescargas que viene integrada. Preciso: Una desviación de la indicación de solo ± 1 % garantiza unas mediciones extremadamente fiables. Con certificado. Flexible: SmartCheck puede montarse prácticamente en cualquier parte. Tanto en posición horizontal como en posición vertical.



Ref.	Código	Cuadrado"	b mm	h mm	t mm	tamaño	€ / u.
8001891	96521202	1/4"	120	124	167	10	Consultar
8001892	96521203	3/8"	120	124	167	100	Consultar
8001893	96521204	3/4"	120	124	167	400	Consultar
8001894	96521205	3/4"	120	124	167	800	Consultar

730N - Llave dinamométrica MANOSKOP®



De disparo. Alojamiento para herramientas acoplables intercambiables. Bloqueo de seguridad QuickRelease. Ajuste rápido y preciso mediante el ajuste rápido QuickSelect. Doble aviso de stop. No es necesario poner a "0".



Ref.	Código	Cuadrado hembra mm	Longitud mm	ft.lb	Nm	Peso grs.	€/ u.
1200291	50181005	9 x 12	330	7-37 ft-lb	10-50 N-m	831	380,00
1200292	50181010	14 x 18	386	15-75 ft-lb	20-100 N-m	988	425,00
1200293	50181012	14 x 18	421	20-95 ft-lb	25-130 N-m	1.128	450,00
1200294	50181020	14 x 18	467	30-150 ft-lb	40-200 N-m	1.264	484,00
1200295	50181040	14 x 18	607	60-300 ft-lb	80-400 N-m	1.655	705,00
1200296	50181065	14 x 18	890	100-480 ft-lb	130-650 N-m	3.231	1.052,00
1200297	50181365	22 x 28	911	100-480 ft-lb	130-650 N-m	3.504	1.080,00
1200298	50181080	22 x 28	1.178	120-600 ft-lb	160-800 N-m	4.825	1.363,00
1200299	50181100	22 x 28	1.363	150-750 ft-lb	200-1000 N-m	5.000	1.703,00

TAW - Llave dinamométrica electrónica de par y ángulo



Cuerpo y mango de Acero. Llave reversible. Precisión (5-100% del rango de par): ±2% (derechas), ±3% (izqda). Visual (doble LEDs+Display), señal de audio vibración. Carraca de 40 dientes con sistema de liberación rápida QR. Ángulo de acción 9°. Capacidad de memoria para 1500 lecturas y hasta 50 prefijados. Hora de apagado automática programable. Retención de datos y parámetros mientras cambio de carga. Rango de temperatura operativa: 5°C - 42°C. Aviso de recalibración programable. Para facilitar la visibilidad: Sobre par -> Se encienden todos los LED. Rango de par -> sólo dos LED. ISO 6789|2004/108/EC. Sin USB.

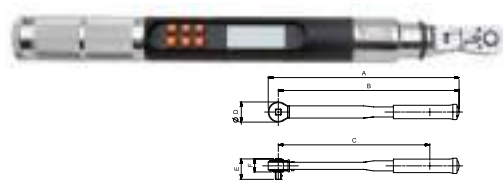

Ref.	Código	Cuadrado exterior"	Longitud mm	med_lb-ft	in.lb	Nm	€/ u.
1201285	TAW34800	3/4	1.235	29.5-590	354-7080	40-800	1.375,26
1201286	TAW38135	3/8	482	5.2-99.5	62-1194	7-135	707,66
1201288	TAW12340	1/2	677	12.5-250	150.5-3009	17-340	774,42

TAWM - Llave dinamométrica electrónica



Cuerpo y mango de Acero. Carraca de 40 dientes con sistema de liberación rápida QR. Llave reversible. Precisión (5-100% del rango de par): ±2% (derechas), ±3% (izqda). ISO 6789|2004/108/EC. Alerta visual mediante LEDs. Alertas visuales y audio programables. Capacidad de memoria para 1.500 lecturas y hasta 50 prefijados. Contador de ciclos. Con mini USB para descargar datos a un PC, sin software especial. Posibilidad de bloquear el teclado, evitando manipulaciones involuntarias. Se pueden programar trabajos de apriete y prefijado de par!!. Hora de apagado automática programable. Retención de datos y parámetros mientras cambio de carga. Aviso de recalibración programable.

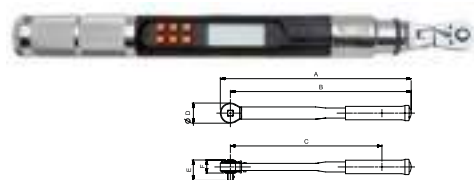

Ref.	Código	Cuadrado exterior"	Longitud mm	med_lb-ft	in.lb	Nm	€/ u.
1201283	TAWM12340	1/2	677	12.5-250	150.5-3009	17-340	1.201,68
1201281	TAWM34800	3/4	1.235	29.5-590	354-7080	40-800	1.729,07
1201280	TAWM38135	3/8	482	5.2-99.5	62-119	7-135	1.222,08

TAWM-Llave dinamométrica electrónica de par y grados, con memoria/USB y cabeza de carraca fija.



Llave dinamométrica electrónica de par y grados, con memoria/USB y cabeza de carraca fija

Ref.	Código	Cuadrado exterior**	Longitud mm	Nm	Graduación escala Nm	€/ u.
21016056	TAWM1412M	1/4	292	0,6-12	0,01	1.052,21
21016057	TAWM1430M	1/4	292	1,5-30	0,01	1.064,97
21016058	TAWM14340	14x18	610	17-340	1	1.265,46
21016059	TAWM24800	24x32	1.180	40-800	1	1.866,87
21016060	TAWM912M	9x12	259	0,6-12	0,01	1.027,38
21016061	TAWM9135	9x12	450	7-135	1	1.177,76
21016062	TAWM930M	9x12	259	1,5-30	1	1.084,84



7454-Llave dinamométrica mecánica de dial



Llave dinamométrica mecánica de dial, cuadradillo fijo y mango de plástico. Doble escala

Ref.	Código	Cuadradillo interior**	Longitud mm	Nm	Graduación escala Nm	€/ u.
21016001	7454-1400	1	1.880	275-1.400	25	2.340,84
21016002	7454-1400E	1	1.194	275-1.400	25	3.814,89
21016007	7454-480	3/4	680	100-480	10	1.027,67
21016010	7454-800E	3/4	1.194	0-800	20	1.712,80



7455- Llave dinamométrica mecánica de disparo



Llave dinamométrica mecánica de disparo ajustable con escala marcada y cabeza fija de carraca. Mango de metal

Ref.	Código	Cuadradillo interior**	Longitud mm	Nm	Graduación escala Nm	€/ u.
21016012	7455-100	3/8	400	20-100	0,5	251,89
21016013	7455-1000	1	1.055	200-1.000	1	1.090,07
21016014	7455-100A	1/2	414	20-100	0,5	238,05
21016015	7455-15	1/4	258	3-15	0,1	251,88
21016016	7455-1500	1	1.780	300-1.500	10	1.989,87
21016017	7455-20	1/4	258	4-20	0,1	251,88
21016018	7455-200	1/2	474	40-200	2	277,07
21016019	7455-25	1/4	286	5-25	0,1	251,88
21016020	7455-2500	1	2.720	500-2.500	10	5.642,17
21016021	7455-300	1/2	483	60-300	2	311,00
21016022	7455-340	1/2	613	60-340	2	311,00
21016023	7455-5	1/4	258	1-5	0,05	251,88
21016024	7455-500	3/4	870	100-500	5	629,71
21016025	7455-60	3/8	393	10-60	0,5	251,89
21016026	7455-800	3/4	1.947	150-800	5	818,64



7465- Llave dinamométrica mecánica de disparo con cabeza intercambiable con escala



Llave dinamométrica mecánica de disparo ajustable con escala marcada y cabeza intercambiable

Ref.	Código	Cuadradillo interior *	Longitud mm	Nm	Graduación escala Nm	€ / u.
21016028	7465-15	9x12	235	3-15	0,1	225,53
21016029	7465-1500	27x36	1.725	300-1.500	10	1.741,58
21016030	7465-200	14x18	445	40-200	2	269,38
21016031	7465-30	9x12	277	6-30	0,1	231,80
21016032	7465-340	14x18	585	60-340	2	294,44
21016033	7465-5	9x12	235	1-5	0,05	220,51
21016034	7465-60	9x12	364	10-60	0,5	238,05
21016035	7465-800	24x32	1.000	150-800	5	751,76
21016027	7465-100	9x12	370	20-100	0,5	238,05



74W-Dinamométrica de disparo mecánica de cabeza Intercambiable con visor



Llave dinamométrica de disparo mecánica ajustable con visor y cabeza intercambiable de conexión rectangular

Ref.	Código	Cuadradillo interior *	Longitud mm	Nm	Graduación escala Nm	€ / u.
21016036	74W14-200	14x18	453	40-200	2	293,17
21016037	74W14-300	14x18	570	60-300	2	329,81
21016038	74W14-400	14x18	664	80-400	5	390,89
21016039	74W9-100	9x12	365	20-100	1	230,87
21016040	74W9-15	9x12	218	3-15	0,2	244,31
21016041	74W9-200	9x12	442	40-200	1	293,17
21016042	74W9-25	9x12	218	5-25	0,2	243,09
21016043	74W9-50	9x12	365	10-50	0,5	230,87



74WR-Llave dinamométrica mecánica de disparo ajustable con visor y cabeza fija de carraca



Llave dinamométrica mecánica de disparo ajustable con visor y cabeza de carraca fija con cuadradillo pasante

Ref.	Código	Cuadradillo interior *	Longitud mm	Nm	Graduación escala Nm	€ / u.
21016044	74WR-100	9x12	387	20-100	1	244,06
21016045	74WR-15	9x12	221	3-15	0,2	256,52
21016046	74WR-200	14x18	470	40-200	2	244,06
21016047	74WR-25	9x12	221	5-25	0,2	256,52
21016048	74WR-300	14x18	593	60-300	2	256,52
21016049	74WR-340	14x18	685	30-340	5	280,95
21016050	74WR-400	14x18	685	80-400	5	339,59
21016051	74WR-50	9x12	335	10-50	0,5	239,42



75R-Llave dinamométrica mecánica de disparo ajustable con visor y cabeza fija de carraca



Llave dinamométrica mecánica de disparo de accionamiento libre ajustable con cabeza fija de carraca

Ref.	Código	Cuadradillo interior *	Longitud mm	Nm	Graduación escala Nm	€ / u.
21016052	75R1-1500	1	1.571	500-1.500	10	1.360,00
21016053	75R3-1000	3/4	1.245	300-1.000	10	1.453,62
21016054	75R3-650	3/4	856	130-650	5	1.087,17
21016055	75R3-800	3/4	1.037	200-800	10	1.215,43

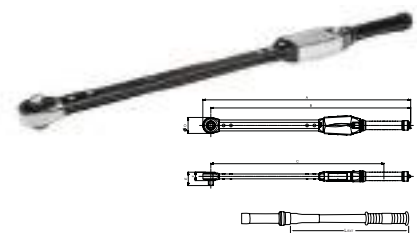

603 Llave dinamométrica corrediza para aprietes a la derecha, precisión de apriete ±6%



UNI EN 26789 ISO 6789

Ref.	Código	Cuadrado	A mm	L mm	Nm	€ / u.
8005130	6030005	1/4	35	195	1-5	689,00
8005131	6030010	1/4	35	195	2-10	700,00



604B Llave dinamométrica de desembrague para aprietes a la derecha y a la izquierda, precisión de apriete ±6%



UNI EN 26789 ISO 6789

Ref.	Código	Ø mm	L mm	Nm	€ / u.
8005132	6040015	8	220	1-5	471,00
8005133	6040020	8	220	2-10	471,00



605E Llave dinamométrica de resorte con carraca reversible para aprietes a la derecha y a la izquierda, precisión de apriete ±6%



UNI EN 26789 ISO 6789

Ref.	Código	Cuadrado	A mm	L mm	Nm	€ / u.
8005134	6050105	1/4	20	190	1-5	227,50
8005135	6050110	1/4	20	190	2-10	243,50



671B/C10-Llave dinamométrica 604B/10 y accesorios



• 1 barra dinamométrica 604B/10 • 1 carraca reversible 611 de 1/4" • 4 llaves fijas 641 de 6-7-8-10-mm • 8 llaves de vaso hexagonales 900 de 4-5-5,5-6-7-8-9-10 mm

Ref.	Código	Contenido	€ / u.
2400071	6710002	Surtido de 1 barra dinamométrica 604B/10 • 1 carraca reversible 611 de 1/4" • 4 llaves fijas 641 de 6-7-8-10-mm • 8 llaves de vaso hexagonales 900 de 4-5-5,5-6-7-8-9-10 mm	1.057,00



671B/C5 Surtido de llave dinamométrica 604B/5 y accesorios



• 1 Llave dinamométrica 604B/5 • 1 carraca reversible 611 de 1/4" • 4 llaves fijas 641 de 5-6-7-8-mm • 8 llaves de vaso hexagonales 900 de 4-5-5,5-6-7-8-9-10 mm

Ref.	Código	Contenido	€ / u.
8005141	6710001	Surtido de 1 barra dinamométrica 604B/5, 1 carraca reversible 611 de 1/4", 4 llaves fijas 641 de 5-6-7-8-mm y 8 llaves de vaso hexagonales 900 de 4-5-5,5-6-7-8-9-10 mm	1.057,00



730 - Equipo base con alojamiento para herramientas acoplables/encajables, DBGM



Service MANOSKOP® 730N. De disparo. Alojamiento para herramientas acoplables intercambiables. Doble aviso de stop. Doble escala de graduación N-m/ft-lb o ft-lb/in-lb. núm. No es necesario poner a "0", dado que el elemento de medición sólo se somete a esfuerzo durante el proceso de apriete. Apriete hacia la izquierda invirtiendo las herramientas acoplables. Si es necesario, reajuste sin desmontar la llave. Con certificado. DBGM. Desviación de la indicación ± 4%.



Ref.	Código	B mm	h mm_1	Cuadrado hembra mm	LF mm	Longitud mm	Nm	ft.lb	Nm	SF mm	Tamaño	€ / u.
1223950	50180080	46	43	24,5 x 28	990	970	160-800 Nm	20 ft.lb	20 Nm	95	80	1.308,00

725 QR - Carraca acoplable



Ref.	Código	Cuadrado Exterior	B mm	h mm_1	Cuadrado macho mm	S mm	€ / u.
1225100	58253004	1/4	22	14,5	9x12	17,5	124,25
1225101	58253005	3/8	29	14,5	9x12	28	126,65
1225102	58253010	1/2	29	14,5	9x12	28	135,00
1225103	58253020	1/2	41	18	14x18	38,5	139,75



NS041-Llave dinamométrica antichispa



Llaves dinamométricas de disparo mecánico ajustable antichispa con visor de escala y cabeza fija de carraca de cobre al berilio

Ref.	Código	cNm	€ / u.
2400362	NS041-12-50	10-50	2.040,81
2400363	NS041-16-100	20-100	2.320,37
2400364	NS041-16-200	40-200	2.523,90
2400365	NS041-16-260	60-260	2.722,94
2400366	NS041-24-670	150-670	8.092,78
2400367	NS041-32-900	200-900	9.192,02
2400368	NS041-8-25	5-25	1.516,07

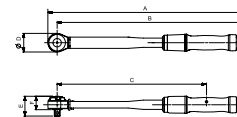

TAH73 R- Llave dinamométrica para trabajo en altura



Llave dinamométrica de disparo mecánico ajustable con visor de escala y cabeza fija de carraca con placa metálica

Ref.	Código	cNm	€ / u.
2400369	TAH73R-100	20-100	442,36
2400370	TAH73R-200	40-200	457,11
2400371	TAH73R-300	60-300	473,96

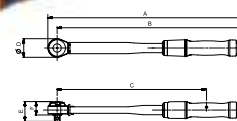

6976 - Destornillador dinamométrico de embrague con dial



Destornillador dinamométrico cuadrado 1/4" Efecto limitador de par en ambos sentidos | Precisión ±6% CW | ISO 6789

Ref.	Código	Cuadrado interior"	cNm	Longitud mm	€ / u.
1273850	TSS120	1/4	10-120 cNM	180 mm	219,12
1273851	TSS600	1/4	1-6 Nm	195 mm	219,12



6973N- Destornillador dinamo métrico ajustable con visor de escala



Ref.	Código	Cuadrado exterior"	cNm	Longitud mm	€ / u.
21016063	6973N	1/4	10-80	150	297,00
21016064	6976N	1/4	40-200	160	303,90
21016065	6978N	1/4	50-450	170	310,61

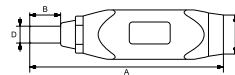

601C Goniómetro digital para aprietes angulares



• Para efectuar aprietes de tornillos con tensiones establecidas previamente mediante la medida del ángulo de torsión • Dotado de avisador acústico (BUZZER) y avisadores luminosos (LEDS) que señalizan la aproximación y el alcance del ángulo seleccionado • Para aprietes a la derecha y a la izquierda • Precisión ángulo: ±2% • Resolución: 0,1° • 9 valores de ángulo preseleccionables • 50 mediciones preseleccionables • Se suministra en estuche de ABS • Alimentación: 2 baterías AAA (incluidas)



Ref.	Código	€ / u.
8005129	6010100	236,50

7440 y 7441 - Destornillador dinamo métrico ajustable Kraftform® serie 7400 con porta-puntas Rapidaptor®



EN ISO 6789. Precisión ± 6%.

Ref.	Código	Nm	Longitud mm	€ / u.
1224200	05074700001	0,3 - 1,2	155	147,02
1224201	05074701001	1,2 - 3,0	155	147,02



7442 y 7443 - Destornillador dinamo métrico ajustable, mango de pistola Kraftform® serie 7400 Rapidaptor®



EN ISO 6789. Precisión ± 6%.

Ref.	Código	Nm	Alto mm	Longitud mm	€ / u.
1224300	05074702001	3,0 - 6,0	100	150	211,43
1224303	05074705001	4,0 - 8,8	100	150	219,62



775 - Destornillador dinamo métrico TORSIOMAX



Ref.	Código	Tamaño	Longitud mm	Portapuntas	Rango	€ / u.
1224400	51060003	3(1)	105	F 6,3	2-30 cN m	402,00
1224401	51060012	12(2)	157	F 6,3	20-120 cN m	427,00
1224402	51060030	30(2)	160	F 6,3	40-300 cN m	475,00
1224403	51060050	50(2)	205	F 6,3	100-500 cN m	484,00
1224404	51060100	100(3)	235	F 6,3	400-1.000 cN m	679,00
1224405	51460003	a/3(1)	105	F 6,3	0,2-3 in.lb	393,00
1224406	51460012	a/12(2)	157	F 6,3	2-12 in.lb	419,00
1224407	51460050	a/50(2)	205	F 6,3	10-50 in.lb	496,00



1430 - Destornillador dinamo métrico



Destornillador dinamo métrico MICRO

Ref.	Código	Descripción	Nm	Largo	ancho	alto	€/ u.
8004555	05074802001	1430 ESDx0,02-0,06	0.02-0.06	145	23	23	355,30
8004556	05074803001	1431 ESDx0,05-0,11	0.05-0.11	145	23	23	355,30



Comprobador para destornilladores dinamo métricos



Robusto: La longevidad típica de STAHLWILLE está asegurada gracias a la protección óptica y acústica contra sobredescargas que viene integrada.
Preciso: Una desviación de la indicación de solo ± 1 % garantiza unas mediciones extremadamente fiables. Con certificado.
Flexible: SmartCheck puede montarse prácticamente en cualquier parte. Tanto en posición horizontal como en posición vertical.



Ref.	Código	Cuadrado"	b mm	h mm	t mm	tamaño	€/ u.
8001890	96521201	1/4"	120	124	167	10S	Consultar

Multiplicador de par manual con placa de reacción

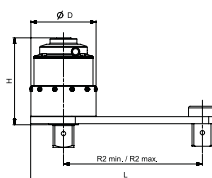

Ref.	Código	Cuadrado interior "	Nm	Factor multiplicación	€/ u.
21016078	9505-3400	1	3.400	5:1	3.890,67
21016079	9525-3400	1,5	3.400	25:1	7.208,79
21016080	9625-9500	1,5	9.500	25:1	6.437,50

Multiplicador de par manual con compensación con brazos de reacción recto y acodado



Ref.	Código	Cuadrado interior "	Nm	Factor multiplicación	€/ u.
21016076	8905-TM	1/2	1.300	5:1	1.493,67
21016077	9505-TM	3/4	2.700	5:1	1.493,67
21016075	89049TM-1000	3/4	1.000	4,8:1	1.575,78

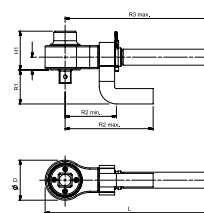

Multiplicador de par manual compacto con brazo de reacción acodado



Ref.	Código	Cuadrado interior**	Nm	Factor multiplicación	€/ u.
21016069	89222CR-1000	3/4	1.000	22,2:1	3.053,84
21016070	9525CR-4000	1	4.000	25:1	4.873,93
21016071	9527CR-2000	1	2.000	27:1	3.359,23
21016072	96255CR-7000	1,5	7.000	25,5:1	6.101,57

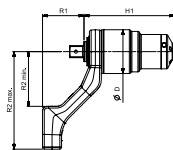

Multiplicador de par manual con brazo de reacción recto



Ref.	Código	Cuadrado interior**	Nm	Factor multiplicación	€/ u.
21016073	95155B-3000	1	3.000	15,5:1	4.336,45
21016074	9526B-4500	1	4.500	26:1	4.519,69

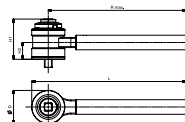

Multiplicador de fuerza MULTIPOWER®



Ref.	Código	No	B mm	Cuadrado interior**	Cuadrado exterior**	ft.lb1)	ft.lb2)	Longitud mm	Multiplicación del momento de torsión	N m1)	N m2)	Reducción engranaje	€/ u.
1430800	53030800	MP300-800	66	1/2	3/4	590	169	215	1 : 3,5	800	229	4 : 1	1.150,00
1431350	53031350	MP300-1350	90	3/4	3/4	996	277	265	1 : 3,6	1.350	375	4 : 1	1.678,00
1432000	53032000	MP300-2000*	95	1/2	1	1.475	118	330	1 : 12,5	2.000	160	16 : 1	3.501,00
1433000	53033000	MP300-3000*	95	3/4	1	2.212	177	330	1 : 12,5	3.000	240	16 : 1	4.150,00
1435000	53035000	MP300-5000*	120	3/4	1 1/2	3.687	217	400	1 : 17,0	5.000	294	20 : 1	6.188,00

334 - Destornillador boca plana



Ref.	Código	a mm	b mm	A mm	L mm	€/ u.
1225600	05007610001	0,8	5,0	100	198	12,21
1225601	05007620001	1	6,0	125	230	17,48
1225602	05011001001	1,2	6,5	150	255	20,06
1225603	05007635001	1,2	7,0	150	255	21,22
1225604	05110011001	1,2	8,0	175	287	21,94
1225605	05110104001	1,6	10,0	200	312	29,64



Destornillador boca plana, antichispa



Las herramientas ENDRES son antichispas, antimagnéticas y muy resistentes a la corrosión. Se fabrican con una aleación (aluminio-bronce especial, cobre-berilio), y están homologadas por los pertinentes organismos oficiales de investigación de materiales. Los moldes y los controles de calidad de las herramientas cumplen las normas DIN. Nuestro alto nivel de calidad se consigue y mantiene gracias a dichos programas de control de calidad.

Ref.	Código	b	L	€/ u.
1280600	EN0804510C	Ø 4,5	100	45,80
1280601	EN0804515C	Ø 4,5	150	62,58
1280602	EN0806010C	Ø 6	100	50,14
1280603	EN0806015C	Ø 6	150	72,74
1280604	EN0808015C	Ø 8	150	89,00
1280605	EN0801020C	Ø 10	200	156,09
1280606	EN0801030C	Ø 10	300	203,04



3334 - Destornillador boca plana, inoxidable



Ref.	Código	a mm	b mm	A mm	L mm	€/ u.
1263600	05032005001	1,2	6,5	150	255	21,10
1263601	05032006001	1,2	8,0	175	195	27,88
1263602	05032007001	1,6	10,0	200	312	35,23



335 - Destornillador boca plana recta



Ref.	Código	a mm	b mm	A mm	L mm	€/ u.
1225700	05008006001	0,4	2,0	60	130	5,85
1225701	05011000001	0,4	2,5	60	130	5,85
1225702	05008007001	0,4	2,5	75	145	6,71
1225703	05110001001	0,5	3,0	80	161	7,01
1225704	05008015001	0,6	3,5	100	181	7,72
1225705	05110002001	0,6	3,5	125	206	8,70
1225706	05110003001	0,6	3,5	200	281	12,21

Ref.	Código	a mm	b mm	A mm	L mm	€/ u.
1225707	05110004001	0,8	4,0	100	198	8,95
1225708	05110005001	0,8	4,0	150	248	11,08
1225709	05110006001	0,8	4,0	200	298	13,85
1225711	05110007001	1	5,5	125	223	13,72
1225712	05008055001	1	5,5	150	248	14,90
1225713	05110008001	1	5,5	200	298	16,09
1225714	05008060001	1	5,5	300	398	19,16

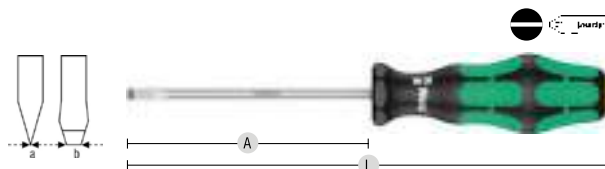

335- Destornillador boca plana recta, corto



Ref.	Código	a mm	b mm	A mm	L mm	€/ u.
21130001	05008840001	0,6	3,5	24,5	54	7,56
21130002	05008841001	0,8	4	24,5	54	8,27
21130003	05008842001	1	5,5	24,5	54	8,40
21130004	05008843001	1,2	6,5	24,5	54	9,00
21130005	05008844001	1,2	8	24,5	54	9,59



3335 - Destornillador boca plana recta, inoxidable



Ref.	Código	a mm	b mm	A mm	L mm	€/ u.
1263500	05032001001	0,5	3,0	80	161	11,82
1263501	05032002001	0,6	3,5	100	181	12,41
1263502	05032003001	0,8	4,0	100	198	12,99
1263503	05032004001	1,0	5,5	125	223	17,01



160 i - Destornillador boca plana, aislado



Ref.	Código	a mm	b mm	A mm	L mm	€/ u.
1242502	05006110001	0,6	3,5	100	181	11,92
1242503	05006115001	0,8	4,0	100	198	14,14
1242504	05006120001	1	5,5	125	223	17,08
1242505	05006125001	1,2	6,5	150	255	22,18
1242506	05006130001	1,2	8,0	175	287	23,89
1242507	05006135001	1,6	8,0	200	312	23,89
1242508	05006140001	1,6	10,0	200	312	29,20

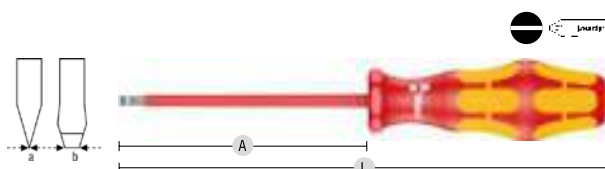

932 A - Destornillador boca plana, varilla pasante



Ref.	Código	a mm	b mm	A mm	L mm	€/ u.
1225900	05018260001	0,6	3,5	100	161	11,73
1225901	05018262001	0,8	4,5	125	188	12,96
1225902	05018264001	1	5,5	150	205	16,92
1225903	05018266001	1,2	7,0	150	230	20,87
1225904	05018268001	1,6	9,0	175	262	27,66
1225905	05018270001	1,6	10,0	200	287	35,04
1225906	05018272001	2	12,0	250	317	42,02
1225907	05018274001	2,5	14,0	250	367	59,58

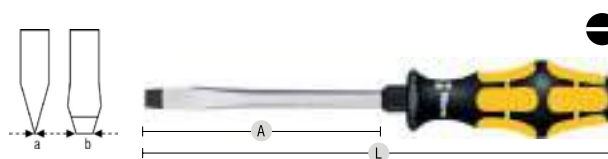

2035 - Destornillador boca plana, para electrónica

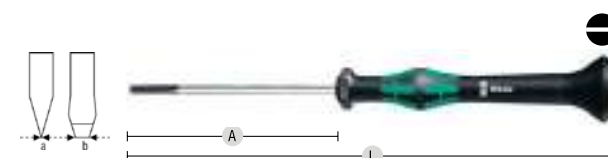

Ref.	Código	b mm	A mm	L mm	€/ u.
1227110	05117990001	0,8	40	137	10,39
1227111	05117991001	1,0	40	137	9,33
1227112	05117992001	1,2	40	137	8,25
1227100	05118000001	1,2	40	137	8,07
1227101	05118002001	1,5	40	137	7,25
1227114	05118003001	1,5	60	157	7,25
1227115	05117993001	1,8	40	137	7,25
1227102	05118004001	1,8	60	157	7,25

Ref.	Código	b mm	A mm	L mm	€/ u.
1227116	05118005001	2,0	40	137	6,32
1227103	05118006001	2,0	60	157	6,32
1227117	05118007001	2,0	100	197	6,79
1227118	05117994001	2,5	50	147	6,32
1227120	05117995001	3,0	50	147	5,93
1227105	05118010001	3,0	80	177	6,54
1227106	05118012001	3,5	80	177	6,32
1227107	05118014001	4,0	80	177	7,20

350 PH - Destornillador PHILLIPS



Ref.	Código	Punta	A mm	L mm	€/ u.
1226000	05008705001	PH 0	60	141	9,86
1226001	05008710001	PH 1	80	178	12,17
1226002	05008712001	PH 1	200	298	13,97
1226003	05008715001	PH 1	300	398	15,84
1226004	05008720001	PH 2	100	205	17,00
1226005	05008725001	PH 2	200	305	20,87
1226006	05008730001	PH 2	300	398	22,91
1226007	05008735001	PH 3	150	262	21,94



350 PH - Destornillador PHILLIPS, corto



Ref.	Código	Punta	A mm	L mm	€/ u.
21130006	05008850001	PH 1	25	54	8,40
21130007	05008851001	PH 2	25	54	9,29
21130008	05008852001	PH 3	25	54	10,01



Destornillador PHILLIPS, antichispa



Las herramientas ENDRES son antichispas, antimagnéticas y muy resistentes a la corrosión. Se fabrican con una aleación (aluminio-bronce especial, cobre-berilio), y están homologadas por los pertinentes organismos oficiales de investigación de materiales. Los moldes y los controles de calidad de las herramientas cumplen las normas DIN. Nuestro alto nivel de calidad se consigue y mantiene gracias a dichos programas de control de calidad.

Ref.	Código	Punta	L mm	€ / u.
1280650	EN0810010C	PH 1	80	41,37
1280651	EN0810020C	PH 2	100	59,57
1280652	EN0810030C	PH 3	150	131,67
1280653	EN0810040C	PH 4	200	156,70



3350 PH - Destornillador PHILLIPS, inoxidable



Ref.	Código	Punta	A mm	L mm	€ / u.
1263701	05032021001	PH 1	80	178	14,31
1263702	05032022001	PH 2	100	205	20,12
1263703	05032023001	PH 3	150	162	29,64



162 i - Destornillador PHILLIPS, aislado



Ref.	Código	Punta	A mm	L mm	€ / u.
1242601	05006152001	PH 1	80	178	15,77
1242602	05006154001	PH 2	100	205	21,30
1242603	05006156001	PH 3	150	262	22,86



917 SPH - Destornillador PHILLIPS, varilla pasante



Ref.	Código	Punta	A mm	L mm	€ / u.
1225800	05017005001	PH 1	80	178	14,14
1225801	05017010001	PH 2	100	205	20,09
1225802	05017015001	PH 3	150	262	29,46
1225803	05017020001	PH 4	200	317	42,83



2050 PH - Destornillador PHILLIPS, para electrónica



Ref.	Código	Punta	A mm	L mm	€ / u.
1227200	05118020001	PH - 00	60	157	8,98
1227201	05118022001	PH - 0	60	157	7,25
1227202	05118024001	PH - 1	80	177	8,61



355 PZ - Destornillador POZIDRIV



Ref.	Código	Punta	A mm	L mm	€ / u.
1226201	05009310001	PZ 1	80	178	14,17
1226202	05009312001	PZ 1	200	298	16,60
1226203	05009315001	PZ 2	100	205	19,52
1226204	05009317001	PZ 2	200	305	22,86
1226205	05009320001	PZ 3	150	262	27,07



355 PZ - Destornillador POZIDRIV, corto



Ref.	Código	Punta	A mm	L mm	€ / u.
21130010	05008853001	PZ 1	25	54	9,59
21130011	05008854001	PZ 2	25	54	10,55
21130012	05008855001	PZ 3	25	54	11,28



3355 PZ - Destornillador POZIDRIV, inoxidable



Ref.	Código	Punta	A mm	L mm	€ / u.
1263801	05032031001	PZ 1	80	178	16,26
1263802	05032032001	PZ 2	100	205	23,04
1263803	05032033001	PZ 3	150	262	33,28



165 i - Destornillador POZIDRIV, aislado



Ref.	Código	Punta	A mm	L mm	€ / u.
1242701	05006162001	PZ 1	80	178	17,40
1242702	05006164001	PZ 2	100	205	23,97
1242703	05006166001	PZ 3	150	262	26,06



2055 PZ - Destornillador POZIDRIV, para electrónica



Ref.	Código	Punta	A mm	L mm	€ / u.
1227300	05118030001	PZ 0	60	157	7,50
1227301	05118032001	PZ 1	80	177	8,35



367 - Destornillador TORX®



Ref.	Código	Punta	A mm	L mm	€ / u.
1226300	05028000001	TX 5	60	130	11,37
1226301	05028001001	TX 6	60	130	11,37
1226302	05028002001	TX 7	60	130	11,27
1226303	05028003001	TX 8	60	141	11,27
1226304	05028004001	TX 9	60	141	11,27
1226305	05028005001	TX 10	80	161	11,27
1226306	05028008001	TX 15	80	178	11,67
1226307	05028010001	TX 20	100	198	11,88
1226308	05028012001	TX 25	100	205	12,52
1226309	05028013001	TX 27	115	220	13,75
1226310	05028015001	TX 30	115	220	14,52
1226311	05028020001	TX 40	130	242	16,22



367- Destornillador TORX®, corto



Ref.	Código	Punta	A mm	L mm	€ / u.
21130013	05008856001	TX 10	25	54	9,29
21130014	05008857001	TX 15	25	54	9,29
21130015	05008858001	TX 20	25	54	9,29
21130016	05008859001	TX 25	25	54	9,29
21130017	05008860001	TX 27	25	54	9,29
21130018	05008861001	TX 30	25	54	9,29
21130019	05008862001	TX 40	25	54	10,42



3367 - Destornillador TORX®, inoxidable



Ref.	Código	Punta	A mm	L mm	€/ u.
1263900	05032050001	TX 8	60	141	13,54
1263901	05032051001	TX 9	60	141	13,54
1263902	05032052001	TX 10	80	161	14,31
1263903	05032053001	TX 15	80	178	14,31
1263904	05032054001	TX 20	100	198	14,51
1263905	05032055001	TX 25	100	-	15,46
1263906	05032056001	TX 27	115	-	16,84
1263907	05032057001	TX 30	115	-	17,79
1263908	05032058001	TX 40	130	-	20,12



167 i - Destornillador TORX®, aislado



Ref.	Código	Punta	A mm	L mm	€/ u.
1242900	05006169001	TX - 9	80	161	13,56
1242901	05006170001	TX - 10	80	161	13,06
1242902	05006172001	TX - 15	80	178	13,45
1242903	05006174001	TX - 20	80	178	13,66
1242904	05006176001	TX - 25	100	205	14,04
1242905	05006177001	TX - 27	100	205	14,87
1242906	05006178001	TX - 30	100	205	15,99
1242907	05006179001	TX - 40	130	242	17,06



367 B0 - Destornillador TORX®, inviolable



Ref.	Código	Punta	A mm	L mm	€/ u.
1226600	05138257001	TX - 7	60	130	15,06
1226601	05138258001	TX - 8	60	141	15,06
1226602	05138259001	TX - 9	60	141	15,06
1226603	05138260001	TX - 10	80	141	15,06
1226604	05138261001	TX - 15	80	178	15,69
1226605	05138262001	TX - 20	100	198	15,89
1226606	05138263001	TX - 25	100	205	16,90
1226607	05138264001	TX - 27	115	220	18,32
1226608	05138265001	TX - 30	115	220	19,34
1226609	05138266001	TX - 40	130	242	21,74



2067 - Destornillador TORX® inviolable para electrónica



Ref.	Código	Punta	A mm	L mm	€/ u.
1227500	05118039001	TX - 4	40	137	13,48
1227501	05118040001	TX - 5	40	137	11,83
1227502	05118042001	TX - 6	40	137	9,80
1227503	05118044001	TX 7 B0	60	157	10,69
1227504	05118046001	TX 8 B0	60	157	10,69
1227505	05118048001	TX 9 B0	60	157	10,36
1227506	05118050001	TX 10 B0	60	157	10,36
1227507	05118052001	TX 15 B0	40	157	11,42
1227508	05118054001	TX 20 B0	60	157	11,42



368 - Destornillador Robertson, corto



Ref.	Código	Punta	A mm	L mm	€/ u.
21130020	05008863001	#01	54	25	9,72
21130021	05008864001	#02	54	25	10,01



354 - Destornillador ALLEN, HEX-PLUS



Ref.	Código	Hexágono mm	A mm	L mm	€ / u.
1226401	05023107001	2,5	75	156	6,84
1226402	05023110001	3,0	75	156	7,09
1226403	05023115001	4,0	75	173	8,10
1226404	05023120001	5,0	80	185	9,52
1226405	05023125001	6,0	80	185	11,12
1226406	05023130001	8,0	100	212	13,45



2054 - Destornillador ALLEN, HEX-PLUS para electrónica



Ref.	Código	Hexágono mm	A mm	L mm	€ / u.
1227400	05118060001	0,7	40	137	10,15
1227401	05118062001	0,9	40	137	8,92
1227402	05118064001	1,3	40	137	7,79
1227403	05118066001	1,5	60	157	7,50
1227404	05118068001	2,0	60	157	6,81
1227405	05118070001	2,5	60	157	6,81
1227406	05118072001	3,0	60	157	6,22



352 - Destornillador ALLEN, HEX-PLUS bola



Ref.	Código	Hexágono mm	A mm	L mm	€ / u.
1226700	05022795001	1,5	60	130	8,87
1226701	05022800001	2,0	100	170	8,87
1226702	05138070001	2,5	100	181	8,87
1226703	05022805001	3,0	100	181	9,00
1226704	05022810001	4,0	100	198	9,97
1226705	05022815001	5,0	100	205	12,45
1226706	05022820001	6,0	125	230	14,94
1226707	05022825001	8,0	150	262	21,74
1226708	05022830001	10,0	150	262	27,66
1226709	05022835001	12,0	150	267	32,57

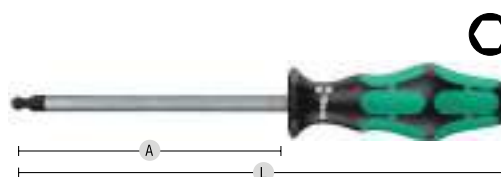

395 HO - Destornillador aprieta-tuercas



Ref.	Código	Hexágono mm	A mm	L mm	€ / u.
1449461	05029461001	5,5	70	168	14,94
1449462	05029462001	6	70	168	14,94
1449463	05029463001	7	80	185	15,40
1449464	05029464001	8	80	185	17,00
1449465	05029465001	10	80	192	18,73
1449466	05029466001	13	80	192	20,35



190 i - Destornillador aprieta-tuercas, aislado



Ref.	Código	Hexágono mm	A mm	€ / u.
1243000	05005300001	5,5	223	22,11
1243001	05005305001	6,0	223	24,25
1243002	05005310001	7,0	230	26,18
1243003	05005315001	8,0	230	28,63
1243004	05005320001	9,0	230	31,14
1243005	05005325001	10,0	237	33,67
1243006	05005330001	11,0	237	36,15
1243007	05005335001	12,0	237	41,23
1243008	05005340001	13,0	237	46,70



247 - Buscapolos



Ref.	Código	A mm	Ø mm	€ / u.
1243100	05005655001	70	3,0	14,04



334/6 - Juego de destornilladores



Ref.	Código	Contenido	Nº piezas	€ / u.
1226900	05105650001	1 334: 6,5 x 150 mm 3 335: 3 x 80; 4 x 100; 5,5 x 125 mm 2 350 PH: PH 1/80; PH 2/100	6	60,37



160i/7 - Juego de destornilladores aislados



Ref.	Código	Contenido	Nº piezas	€ / u.
1243300	05006147001	4 160 i: 2,5 x 80; 3,5 x 100; 4 x 100; 5,5 x 125 mm 2 162 i: PH 1/80; PH 2/100; 247 : 3 x 70 mm	7	66,98



3334/6 - Juego de destornilladores inoxidables



Ref.	Código	Contenido	Nº piezas	€ / u.
1264000	05032060001	1 3334: 1,2 x 6,5 x 150 3 3335: 0,5 x 3,0 x 80; 0,8 x 4,0 x 100; 1,0 x 5,5 x 125 mm 2 3350 PH: PH 1 x 80; PH 2 x 100	6	78,26



932/6 - Juego de destornilladores varilla pasante



Varilla pasante.

Ref.	Código	Contenido	Nº piezas	€ / u.
1227000	05018282001	4 932 A: 3,5 x 80; 4,5 x 90; 5,5 x 100; 7,0 x 125 mm 2 917 PH: PH 1/80; PH 2/100	6	77,66



2035/6 B - Juego de destornilladores para usos electrónicos



Ref.	Código	Contenido	Nº piezas	€ / u.
1227700	05118152001	4 2035: 0,4 x 2,5; 0,5 x 3,0; 0,6 x 3,5; 0,8 x 4,0 2 2050: PH 0; PH 1	6	46,53



2035/6 A - Juego de destornilladores para usos electrónicos



Ref.	Código	Contenido	Nº piezas	€ / u.
1227600	05118150001	4 2035: 0,3 x 1,8; 0,4 x 2,0; 0,4 x 2,5; 0,5 x 3,0 2 2050: PH 00; PH 0	6	46,53



Juego de destornilladores cortos



Ref.	Código	Contenido	€ / u.
21130022	05008870001	2 350: PH 1;PH 2; 3 335 0,6x35;0,8x4;1x5,5	38,37
21130023	05008871001	2 355: PZ 1;PZ 2; 3 335 0,6x35;0,8x4;1x5,5	40,17
21130024	05008872001	1 335: 1x5,5; 2 350: PH1;PH2; 2 368: #1;#2	38,37
21130025	05008876001	5 367: TX 10;TX 15;TX 20;TX 25;TX 27	40,76



80 RA - Mango VARIO de carraca



Ref.	Código	Descripción	Longitud mm	€ / u.
1228050	05002901001	para varillas tipo Vario de 6mm	115	43,50



1210E/GE-Destornillador eléctrico



Destornillador a batería recargable, 250 rpm, 1,2Nm por ciclo de carga, iluminación por led frontal. Compatible con todo tipo de puntas.

Ref.	Código	€ / u.
2400072	12100701	150,00



91 - Extensión VARIO



Ref.	Código	Longitud mm	€ / u.
1228200	05003210001	175	24,01

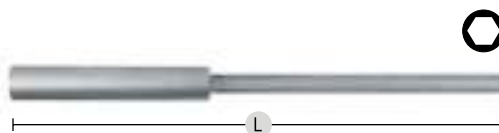

830 - Adaptador porta-puntas VARIO



Ref.	Código	Longitud mm	€ / u.
1228300	05051835001	165	31,53



81 - Varilla plana combinada



Ref.	Código	a mm	B mm	Longitud mm	€ / u.
1228400	05002910001	4,0	6	175	11,88
1228401	05002913001	5,0	7	175	11,88

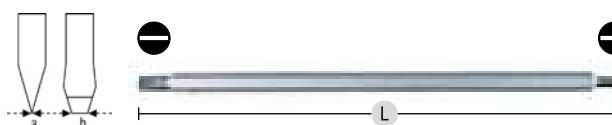

82 - Varilla PH - plana combinada



Ref.	Código	Punta	B mm	a mm	Longitud mm	€ / u.
1228500	05002920001	PH 1	4,0	0,6	175	11,88
1228501	05002923001	PH 2	6,0	1,0	175	11,88
1228502	05002926001	PH 3	7,0	1,2	175	11,88



83 - Varilla PH - PZ combinada



Ref.	Código	Punta	Punta	Longitud mm	€ / u.
1228600	05002930001	PH 1	PZ1	175	11,88
1228601	05002933001	PH 2	PZ2	175	11,88



Kraftfrom Kompakt Vario 88/1



Ref.	Código	Contenido	€ / u.
1452990	05002990001	○ 80	1 x 6x98
		⊕ 85	1 x PH 1xPH 2x175
		⊕ 86	1 x PZ 1xPZ 2x175
		⊕ 87	1 x TX 10xTX 15x175;
			1 x TX 20xTX 25x175;
			1 x TX 30xTX 40x175
		● 81	1 x 0,6x4,0x1,0x6,0x175;
			1 x 0,8x5,0x1,2x7,0x175
		○ 84	1 x 4x4x175;
			1 x 5x5x175;
	1 x 6x6x175		
		156,95	



Kraftfrom Kompakt Vario RA SB con carraca



Ref.	Código	Contenido	€ / u.
1453665	05073665001	○ 80 RA 1 x 6x115,0	99,91
		⊕ 85 1 x PH 1xPH 2x175	
		⊕ 86 1 x PZ 1xPZ 2x175	
		⊕ 87 1 x TX 10xTX 15x175;	
		1 x TX 20xTX 25x175	
		● 81 1 x 0,6x4,0x1,0x6,0x175	
○ 84 1 x 4x5x175			



Kraftfrom Kompakt 60 RA con carraca



Ref.	Código	Contenido	€ / u.
1451040	05051040001	○ 816 RA 1 x 1/4"x142,0	143,87
		⊕ 851/4 Z PH 1 x PH 1x89; 1 x PH 2x89;	
		1 x PH 3x89	
		⊕ 855/4 Z PZ 1 x PZ 1x89; 1 x PZ 2x89;	
		1 x PZ 3x89	
		⊕ 867/4 Z TORX® BO 1 x TX 10x89;	
1 x TX 15x89; 1 x TX 20x89;			
1 x TX 25x89; 1 x TX 30x89			
● 800/4 Z 1 x 1,0x5,5x89			
○ 840/4 Z Hex-Plus 1 x 3,0x89; 1 x 4,0x89;			
1 x 5,0x89; 1 x 6,0x89			



Kraftfrom Kompakt 62



Ref.	Código	Contenido	€ / u.
1229400	05059297001	⊕ 851/4 Z PH1, PH2, PH3	182,98
		⊕ 855/4 Z PZ1, PZ2, PZ3	
		⊕ 867/4 Z BO TX8, TX10, TX15, TX20,	
		TX25, TX27, TX30, TX40	
		○ 840/4 BO SW2, SW2,5, SW3, SW4,	
		SW5, SW6	
800/4 Z 1,2 x 6,5			
⊕ 871/4 Z #6, #8, #10			
⊕ 875/4 Z #1, #2, #3, #4			



Kraftfrom Kompakt 70



Ref.	Código	Contenido	€ / u.
1451041	05057110001	● 816 RA 1 x 1/4"x119	120,67
		● 889/4/1 K 1 x 1/4"x50	
		⊕ 851/1 TZ PH 3 x PH 1x25;	
		3 x PH 2x25;	
		3 x PH 3x25	
		⊕ 855/1 TZ PZ 3 x PZ 1x25;	
		3 x PZ 2x25;	
		3 x PZ 3x25	
		⊕ 867/1 Z TORX® BO 1 x TX 10x25;	
		1 x TX 15x25;	
1 x TX 20x25;			
1 x TX 25x25;			
x TX 30x25;			
1 x TX 40x25			
● 800/1 TZ 1 x 0,6x4,5x25;			
1 x 1,0x5,5x25;			
1 x 1,2x6,5x25			
○ 840/1 Z Hex-Plus 1 x 4,0x25;			
1 x 5,0x25;			
1 x 6,0x25			



Kraftfrom Kompakt con varilla telescópica y depósito de puntas



Ref.	Código	Modelo	Contenido	Características	€/ u.
1451021	05051021001	KK 20	<ul style="list-style-type: none"> ⊕ 851/1 Z PH 1 x PH 1x25; 1 x PH 2x25 ⊕ 855/1 Z PZ 1 x PZ 1x25; 1 x PZ 2x25 ⊕ 800/1 Z 1 x 1,0x5,5x25; 1 x 1,2x6,5x25 	Magnético. Porta-puntas de cambio rápido. Bolso para colocar en el cinturón	93,50
1453660	05073660001	KK 27 RA 1 SB	<ul style="list-style-type: none"> ⊕ 851/1 Z PH 1 x PH 1x25; 1 x PH 2x25 ⊕ 855/1 Z PZ 1 x PZ 1x25; 1 x PZ 2x25 ⊕ 800/1 Z 1 x 1,0x5,5x25; 1 x 1,2x6,5x25 	Varilla no extraíble. De carraca.	76,30
1453240	05073240001	KK 28 SB	<ul style="list-style-type: none"> ⊕ 851/1 Z PH 1 x PH 1x25; 1 x PH 2x25 ⊕ 855/1 Z PZ 1 x PZ 1x25; 1 x PZ 2x25 ⊕ 800/1 Z 1 x 1,0x5,5x25; 1 x 1,2x6,5x25 	Magnético. Porta-puntas de cambio estándar.	52,40

Kraftfrom Kompakt, aislado



Ref.	Código	Modelo	Contenido	€/ u.
1453470	05003470001	KK 60 i/7	<ul style="list-style-type: none"> ● 817 VDE 1 x 9x102 ⊕ KK 62 i 1 x PH 1x154; 1 x PH 2x154 ⊖ KK 60 i 1 x 0,4x2,5x154; 1 x 0,6x3,5x154; 1 x 0,8x4,0x154; 1 x 1,0x5,5x154 	73,35
1453471	05003471001	KK 60 i/62 i/65 i/18	<ul style="list-style-type: none"> ⊖ KK 60 i 1 x 1,0x5,5x154; 1 x 0,4x2,5x154; 1 x 0,6x3,5x154; 1 x 0,8x4,0x154 ● 817 VDE 1 x 9x102 ⊕ KK 62 i 1 x PH 1x154; 1 x PH 2x154 ⊕ KK 62 i PH/S 1 x # 1x154; 1 x # 2x154 ⊕ KK 65 i PZ 1 x PZ 1x154; 1 x PZ 2x154 ⊕ KK 65 i PZ/S 1 x # 1x154; 1 x # 2x154 ⊖ KK 96 VK 6,3 1 x 6,3x89 ⊖ KK 97 VK 8,1 1 x 8,1x89 ⊖ KK 98 DK 1 x 89 ⊖ KK 99 FL 1 x 89 ● 247 1 x 0,5x3,0x70 	130,95



897/4 R - RAPIDAPTOR® BITORSION®



Ref.	Código	Hexágono"	Inserción"	Longitud mm	Ø mm	€/ u.
1229900	05053923001	1/4	1/4	75	15,0	37,92



3888/4/1 K RAPIDAPTOR® - porta-puntas universal C+E 6,3 inoxidable



Ref.	Código	Conexión "	Longitud mm	€/ u.
1265000	05071100001	1/4	50	35,62



899/4/1 - Porta-puntas universal



Ref.	Código	Hexágono "	Inserción	Longitud mm	Ø mm	€ / u.
1230000	05053457001	1/4	1/4"	50	15,0	11,35
1230001	05053455001	1/4	1/4"	75	10,5	18,57
1230002	05053459001	1/4	1/4"	100	10,5	19,81
1230003	05053458001	1/4	1/4"	152	10,5	22,17



Adaptadores de cambio rápido



Ref.	Código	Hexágono "	Longitud mm	Para	€ / u.
1462490	05052490001	1/4	57	887/4 RR	37,92
1462503	05052503001	1/4	75	889/4/1	31,06
1467676	05057676001	1/4	75	897/4 Impaktor R	37,92

887/4 RR



869/4 M - Aprieta-tuercas, magnético



Ref.	Código	Hexágono mm	Longitud mm	€ / u.
1460420	05060420001	5.5	50	9,80
1460421	05060421001	6	50	9,80
1460422	05060422001	7	50	9,80
1460423	05060423001	8	50	9,80
1460425	05060425001	10	50	9,80
1460428	05060428001	13	50	11,97



800/1Z - Punta plana corta



Ref.	Código	Punta	Longitud mm	€ / u.
1230500	05072050001	4,0x0,5	25	1,61
1230501	05072055001	4,5x0,6	25	1,61
1230502	05072057001	5,5x0,8	25	1,61
1230503	05072059001	5,5x1,0	25	1,61
1230504	05072061001	6,5x1,2	25	1,61
1230505	05072065001	8,0x1,6	25	3,90



800/4 Z - Punta plana larga



Ref.	Código	Punta	Longitud mm	€ / u.
1469305	05059305001	0.5 x 3.0	50	5,82
1469310	05059310001	0.6 x 3.5	50	5,82
1469320	05059320001	0.8 x 4.0	50	5,82
1469325	05059325001	0.8 x 5.5	50	5,82
1469337	05059337001	1.2 x 6.5	50	5,82

Ref.	Código	Punta	Longitud mm	€ / u.
1469340	05059340001	1.2 x 8.0	50	5,82
1469480	05059480001	0.8 x 4.0	89	8,39
1469488	05059488001	1.0 x 5.5	89	8,39
1469490	05059490001	1.2 x 6.5	89	8,39
1469496	05059496001	1.2 x 8.0	89	8,39



851/1Z - Punta PHILLIPS



Ref.	Código	Punta	Longitud mm	€ / u.
1230100	05056500001	PH 0	25	1,49
1230101	05072070001	PH 1	25	0,96
1230102	05072072001	PH 2	25	0,96
1230103	05072074001	PH 3	25	0,96

Ref.	Código	Punta	Longitud mm	€ / u.
1230104	05056535001	PH 4	32	4,97
1230105	05056507001	PH 1	50	3,28
1230106	05056520001	PH 2	50	3,28
1230107	05134905001	PH 3	50	3,28

851/1 IMP DC Punta PHILLIPS



Ref.	Código	Punta	Longitud mm	€ / u.
1467615	05057615001	PH 1	25	50,64
1467616	05057616001	PH 2	25	50,64
1467617	05057617001	PH 3	25	50,64

851/4 IMP DC Punta PHILLIPS



Ref.	Código	Punta	Longitud mm	€ / u.
1467656	05057656001	PH 2	50	39,45
1467657	05057657001	PH 3	50	39,45

851/1 TZ Punta PHILLIPS



Ref.	Código	Punta	Longitud mm	€ / u.
1466505	05056505001	PH 1	25	2,06
1466510	05056510001	PH 2	25	2,06
1466525	05056525001	PH 3	25	2,06

851/4 TZ Punta PHILLIPS



Ref.	Código	Punta	Longitud mm	€ / u.
1469805	05059805001	PH 1	50	3,96
1469810	05059810001	PH 2	50	3,96
1469815	05059815001	PH 3	50	3,96

Caja Tic-Tac 25 puntas ExtraHard



La punta de atornillar Extra Hard es una buena opción para un uso universal. El acero modificado S2 y un tratamiento térmico optimizado confieren una calidad extrafuerte para un buen rendimiento. La zona de torsión cónica soporta fácilmente los picos de torque, lo cual permite completar cualquier tarea.



Ref.	Código	Punta	Longitud mm	€ / u.
2400063	2607002797	PH2	25	13,49

851/4 Z Punta PHILLIPS extra-larga



Ref.	Código	Punta	Longitud mm	€/ u.
1469760	05059760001	PH 1	89	8,36
1469775	05059775001	PH 2	89	8,36
1469795	05059795001	PH 3	89	8,36



3851/1 TS - Punta PHILLIPS inoxidable



Ref.	Código	Punta	Longitud mm	€/ u.
1264500	05071010001	PH 1	25	5,45
1264501	05071011001	PH 2	25	5,45
1264502	05071012001	PH 3	25	5,45



855/4 IMP DC Punta POZIDRIV



Ref.	Código	Punta	Longitud mm	€/ u.
1467661	05057661001	PZ 2	50	39,45
1467662	05057662001	PZ 3	50	39,45



855/4 TH - Punta POZIDRIV, extradura



Ref.	Código	Punta	Longitud mm	€/ u.
1230403	05060055001	PZ 1	50	3,96
1230404	05060060001	PZ 2	50	3,96
1230405	05060065001	PZ 3	50	3,96



855/1 IMP DC - Punta POZIDRIV



Ref.	Código	Punta	Longitud mm	€/ u.
1467630	05057620001	PZ 1	25	50,64
1467631	05057621001	PZ 2	25	50,64
1467632	05057622001	PZ 3	25	50,64



Caja Tic-Tac 25 puntas ExtraHard



La punta de atornillar Extra Hard es una buena opción para un uso universal. El acero modificado S2 y un tratamiento térmico optimizado confieren una calidad extrafuerte para un buen rendimiento. La zona de torsión cónica soporta fácilmente los picos de torque, lo cual permite completar cualquier tarea.



Ref.	Código	Punta	Longitud mm	€/ u.
2400064	2607002798	PZ2	25	13,49



3855/1 TS - Punta POZIDRIV, inoxidable



Ref.	Código	Punta	Longitud mm	€ / u.
1264600	05071020001	PZ 1	25	5,45
1264601	05071021001	PZ 2	25	5,45
1264602	05071022001	PZ 3	25	5,45



867/1 IMP DC Punta TORX®



Ref.	Código	Punta	Longitud mm	€ / u.
1467622	05057628001	TX 10	25	59,51
1467623	05057623001	TX 15	25	59,51
1467624	05057624001	TX 20	25	59,51
1467625	05057625001	TX 25	25	59,51
1467626	05057626001	TX 30	25	59,51
1467627	05057627001	TX 40	25	59,51



867/1 TZ - Punta TORX®, corta



Ref.	Código	Punta	Longitud mm	€ / u.
1230600	05066300001	TX 5	25	2,71
1230601	05066301001	TX 6	25	2,71
1230602	05066302001	TX 7	25	2,71
1230603	05066303001	TX 8	25	2,71
1230604	05066304001	TX 9	25	2,71
1230605	05066305001	TX 10	25	2,71

Ref.	Código	Punta	Longitud mm	€ / u.
1230606	05066308001	TX 15	25	2,71
1230607	05066310001	TX 20	25	2,71
1230608	05066312001	TX 25	25	2,71
1230609	05066313001	TX 27	25	2,71
1230610	05066315001	TX 30	25	2,71
1230611	05066320001	TX 40	25	2,71



867/4 - Punta TORX®, larga



Ref.	Código	Punta	Longitud mm	€ / u.
1274205	05308428001	TX 6	50	5,94
1274207	05060131001	TX 8	50	5,94
1274208	05060132001	TX 10	50	5,94
1274209	05060133001	TX 15	50	5,94
1274210	05060134001	TX 20	50	5,94
1274211	05060135001	TX 25	50	5,94
1274212	05060136001	TX 27	50	5,94
1274213	05060137001	TX 30	50	5,94
1274214	05060138001	TX 40	50	5,94



867/4 - Punta TORX®, extra-larga



Ref.	Código	Punta	Longitud mm	€ / u.
1460186	05060186001	TX 10	89	10,63
1460187	05060187001	TX 15	89	10,63
1460188	05060188001	TX 20	89	10,63
1460189	05060189001	TX 25	89	10,63
1460191	05060191001	TX 30	89	10,63
1460192	05060192001	tx 40	89	10,63



3867/1 TS - Punta TORX®, inoxidable



Ref.	Código	Punta	Longitud mm	€ / u.
1264900	05071030001	TX 8	25	6,42
1264903	05071033001	TX 15	25	6,42
1264904	05071034001	TX 20	25	6,42
1264905	05071035001	TX 25	25	6,42
1264907	05071037001	TX 30	25	6,42
1264908	05071038001	TX 40	25	6,42



867/1 Z IP - Punta TORX® PLUS



Ref.	Código	Punta	Longitud mm	€ / u.
1466280	05066280001	IP 10	25	4,56
1466282	05066282001	IP 15	25	4,56
1466284	05066284001	IP 20	25	4,56
1466286	05066286001	IP 25	25	4,56
1466288	05066288001	IP 30	25	4,56
1466290	05066290001	IP 40	25	4,56



840/1Z - Punta ALLEN, HEX-PLUS



Ref.	Código	Hexágono mm	Longitud mm	€ / u.
1230701	05056305001	2,0	25	3,30
1230702	05056310001	2,5	25	3,30
1230703	05056315001	3,0	25	3,30
1230704	05056320001	4,0	25	3,30
1230705	05056325001	5,0	25	3,30
1230706	05056330001	6,0	25	3,30
1230707	05056335001	8,0	25	4,68
1230708	05056340001	10,0	25	4,68



840/4Z - Punta ALLEN, HEX-PLUS larga



Ref.	Código	Hexágono mm	Longitud mm	€ / u.
1230800	05059603001	2,0	50	6,26
1230801	05059604001	2,5	50	6,26
1230802	05059605001	3,0	50	6,26
1230803	05059610001	4,0	50	6,26
1230804	05059615001	5,0	50	6,26
1230805	05059620001	6,0	50	6,26
1230806	05059625001	8,0	50	10,33



840/4 Z - Punta ALLEN, HEX-PLUS extra-larga



Ref.	Código	Hexágono mm	Longitud mm	€ / u.
1469628	05059628001	2.0	89	13,44
1469629	05059629001	2.5	89	13,44
1469630	05059630001	3.0	89	13,44
1469631	05059631001	4.0	89	13,44
1469632	05059632001	5.0	89	13,44
1469633	05059633001	6.0	89	13,44



840/1 - Punta ALLEN, HEX-PLUS inviolable



Ref.	Código	Punta	Longitud mm	€/ u.
1274400	05056341001	2,0	25	7,01
1274401	05056342001	2,5	25	7,01
1274402	05056343001	3,0	25	7,01
1274403	05056344001	4,0	25	7,01
1274404	05056345001	5,0	25	7,01
1274405	05056346001	6,0	25	7,01



3840/1 TS - Punta ALLEN, HEX-PLUS, inoxidable



Ref.	Código	Hexágono mm	Longitud mm	€/ u.
1264800	05071070001	1,5	25	6,42
1264801	05071071001	2,0	25	6,42
1264802	05071072001	2,5	25	6,42
1264803	05071073001	3,0	25	6,42
1264804	05071074001	4,0	25	6,42
1264805	05071075001	5,0	25	6,42
1264806	05071076001	6,0	25	6,42



Set de 32 puntas ExtraHard



La punta de atornillar Extra Hard es una buena opción para un uso universal. El set de puntas de atornillar de 32 piezas es una buena opción para un uso universal. El set contiene puntas de atornillar diversas. Se ofrece en una caja pequeña y compacta con tapa transparente apta para colocar en un cinturón para facilitar el acceso.

Ref.	Código	Contenido	Longitud mm	€/ u.
2400065	2607017319	PH1; PH2; PH3; PZ1; PZ2; PZ3; HEX3; HEX4; HEX5; HEX6; T10; T15; T20; T25; T27; T30; T40; SL3; SL4; SL5; SL6; TH10; TH15; TH20; TH25; TH27; TH30; TH40	25	17,97



Set con 43 unidades para atornillar



La punta de atornillar Extra Hard es una buena opción para un uso universal. El acero modificado S2 y un tratamiento térmico optimizado confieren una calidad extrafuerte para un sólido rendimiento. La zona de torsión cónica soporta los picos de torque fácilmente al atornillar en cualquier material. Las puntas están codificadas por colores para ver y reconocer el tipo adecuado rápidamente.

Ref.	Código	Contenido	Longitud mm	€/ u.
2400066	2607017164	PH1; PH2; PH3; PZ1; PZ2; PZ3; SL3; SL4; SL5; SL6; HEX3; HEX4; HEX5; HEX6; T10; T15; T20; T25; T27; T30; T40; TH10; TH15; TH20; TH25; TH27; TH30; TH40	25;75;48;50	40,48



Impaktor Bit-Check



Ref.	Código	Contenido	Modelo	€ / u.
1467682	05057682001	897/4 Impaktor R 1/4"x75	Bit-Check 10 Impaktor 2	83,12
		3 PH 2x25;		
		1 PH 3x25		
		3 TX 25x25;		
		1 TX 30x25		
1 TX 40x25				
1467683	05057683001	897/4 Impaktor R 1/4"x75	Bit-Check 10 Impaktor 3	83,12
		3 PZ 2x25;		
		1 PZ 3x25		
		3 TX 25x25;		
		1 TX 30x25		
1 TX 40x25				



Bit - Check 7PZ Diamond 1



Ref.	Código	Contenido	€ / u.
1466371	05057412001	889/4/1 K Rapidaptor 2 PZ 1x25; 3 PZ 2x25; 1 PZ 3x25;	51,85



8100-9/TZ Bit-Check



Ref.	Código	Contenido	€ / u.
1466161	05056161001	895/4/1 K 1/4"x52	52,60
		1 0,8x5,5x25;	
		1 1,0x5,5x25;	
		1 1,2x6,5x25	
		1 PH 1x25;	
		1 PH 2x25;	
		1 PH 3x25	
		1 PZ 1x25;	
		1 PZ 2x25;	
		1 PZ 3x25	



Set X-Pro con 35 unidades para atornillar y taladrar hormigón



Uso universal para aplicaciones de atornillar y perforación./ La punta de atornillar Extra Hard es una buena opción para un uso universal./ El acero modificado S2 y un tratamiento térmico optimizado confieren una calidad extrafuerte para un buen rendimiento./ Puntas de atornillar de acero modificado S2 de calidad extradura. Zona de torsión cónica tolera los picos de torsión./ Las puntas de atornillar están codificadas por colores para ver y reconocer el tipo adecuado rápidamente

Ref.	Código	Contenido	Longitud mm	€ / u.
2400067	2607017326	PH1; PH2; PH3; PZ1; PZ2; PZ3; SL3; SL4; SL5; SL6; HEX3; HEX4; HEX5; HEX6; TH10; TH15; TH20; TH25; TH27; TH30; TH40	25; 25; 25; 25; 25; 50; 70; 75; 85; 85; 100; 150; 60; 60	43,18



Bit - Check 10 Universal



De 52 piezas; en una caja compacta de material textil muy robusta que no perjudica las superficies. Poco volumen y un peso reducido para una mayor movilidad. Un juego de herramientas muy compacto con 52 útiles de atornillar. 1 porta-puntas manual Rapidaptor de cambio rápido; 1 porta-puntas B Rapidaptor de cambio rápido para insertar en la máquina atornilladora o para conectar con el adaptador del taladro electrónico; 30 puntas BiTorsion con un largo de 25 mm, para una gran longevidad, duras y resistentes (BTZ), para el uso universal, extraduras (BTH), 12 puntas Impaktor con un largo de 50 mm para exigencias especialmente altas, 8 llaves acodadas con perfil Hex-Plus (evita el redondeado de tornillos de hexágono interior) y una cabeza de bola hexagonal en el brazo largo para trabajos en rincones; una caja de material textil muy robusta y de gran durabilidad; se deja posicionar de forma vertical para un depósito más ordenado en la estantería del taller; el material textil exterior ofrece una protección adicional de las superficies.



Ref.	Código	Contenido	€ / u.
1213100	05057460001	● 813 R 1 x 1/4"x90	157,05
		● 889/4/1 K 1 x 1/4"x50	
		⊕ 851/1 BTZ PH 2 x PH 1x25; 4 x PH 2x25; 2 x PH 3x25	
		⊕ 851/4 IMP DC 2 x PH 2x50; 1 x PH 3x50	
		⊕ 855/1 BTH PZ 2 x PZ 1x25; 4 x PZ 2x25; 2 x PZ 3x25	
		⊕ 855/4 IMP DC 2 x PZ 2x50; 1 x PZ 3x50	
		⊕ 867/1 TORX® BTZ 2 x TX 10x25; 2 x TX 15x25; 3 x TX 20x25; 2 x TX 25x25; 2 x TX 30x25; 1 x TX 40x25	
		⊕ 867/4 IMP DC 1 x TX 25x50; 1 x TX 30x50; 1 x TX 40x50	
		⊖ 800/1 BTZ 1 x 0,8x5,5x25; 1 x 1,0x5,5x25	
		⊖ 840/4 IMP DC 1 x 4,0x50; 1 x 5,0x50; 1 x 6,0x50	
		⊖ 950 PKS 1 x 1,5x50 1); 1 x 2,0x56; 1 x 2,5x63; 1 x 3,0x71; 1 x 4,0x80; 1 x 5,0x90; 1 x 6,0x100; 1 x 8,0x112	

Set atornillar flexible 200mm con 11uds



Ref.	Código	Contenido	Longitud mm	€ / u.
2400068	2608522376	PH1; PH2; PH3; PZ2; HEX4; HEX5; T20; T25; SLO,6x4,5; SLO,8x5,5	25	12,52



Llave universal para armarios de distribución "TWINKEY"



10 bocas, 2 cruces, 1 llave. Con punta reversible y llaves ajustadas por imán. Válida para todos los sistemas de paso estándar (calefacción, fontanería, suministros de gas y agua...).

Ref.	Código	Longitud mm	€ / u.
1461101	00 11 01	92	34,27



Llave para armarios de distribución

Llave para cabinas de control Knipex. Para armarios registro y cabinas de control. Compatibles con los cierres y pasos más habituales en gas, agua y electricidad.

Ref.	Código	Longitud mm	€ / u.
1461103	00 11 03	76	24,89





Llave para armarios de distribución

Llave para cabinas de control. Para armarios registro y cabinas de control. Compatibles con los cierres y pasos más habituales en gas, agua y electricidad.



Ref.	Código	Medidas	€ / u.
8004740	01103	62x62	21,06
8004741	01104	90x62	19,14

2630GC - Alicata universal con capilla



Ref.	Código	A mm	B mm	C mm	d mm	E mm	G mm	€ / u.
1274450	2630GC-160IP	160	33	23	11.5	3.5	12	19,79
1274451	2630GC-180IP	180	36	25	11.0	4.0	14	19,94
1274452	2630GC-200IP	200	39	27	13.0	4.5	16	22,81

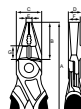

0201 - Alicata universal de fuerza



Filos con dureza 63 HRC. Efecto palanca optimizado. Hasta un 35% menos de esfuerzo que un alicata convencional. Mangos recubiertos de plástico.

Ref.	Código	Longitud mm	Alambre duro	Cuerda de piano mm	€ / u.
1461180	02 01 180	180	2,5	2,0	22,29
1461200	02 01 200	200	2,8	2,0	23,21
1461225	02 01 225	225	3,0	2,5	26,62



0202 - Alicata universal de fuerza



Filos con dureza 63 HRC. Efecto palanca optimizado. Hasta un 35% menos de esfuerzo que un alicata convencional. Mangos con fundas bicomponentes.

Ref.	Código	Longitud mm	Alambre duro	Cuerda de piano mm	€ / u.
1231000	02 02 180	180	2,5	2,0	25,25
1231001	02 02 200	200	2,8	2,0	27,39
1231002	02 02 225	225	3,0	2,5	32,54



0301 - Alicata universal



Filos templados por inducción con dureza 60 HRC. Gran capacidad de corte. Mangos recubiertos de plástico.

Ref.	Código	Longitud mm	Alambre duro	€ / u.
1231100	03 01 140	140	1,8	16,83
1231101	03 01 160	160	2,0	15,45
1231102	03 01 180	180	2,2	16,37
1231103	03 01 200	200	2,5	18,87
1231104	03 01 250	250	2,5	29,78



Alicate universal



Cabeza pulida, con mangos bicomponente.

Ref.	Código	Longitud mm	Ø Alambre duro mm	€/ u.
8004742	32160	160	1,8	16,30
8004743	32180	180	2,5	17,28
8004744	32200	200	2,8	21,08



0302 - Alicate universal



Filos templados por inducción con dureza 60 HRC. Gran capacidad de corte.
Mangos con fundas bicomponentes.

Ref.	Código	Longitud mm	Ø Alambre duro	€/ u.
1231200	03 02 160	160	2,0	20,09
1231201	03 02 180	180	2,2	20,45
1231202	03 02 200	200	2,5	23,51



2628D - Alicate universal plano



DIN ISO 5746. Dureza: Total 42-46 HRC. Corte: 61-63 HRC.

Ref.	Código	A mm	B mm	C mm	d mm	E mm	G mm	€/ u.
1231350	2628 D-160	160	33	23	11	3,5	12	20,81
1231351	2628 D-180	180	36	25	11	4	14	23,80
1231352	2628 D-200	200	41	29	12	4,5	16	25,04

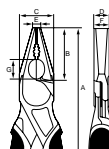

ergo®

2628GC - Alicate universal plano



Ref.	Código	A mm	B mm	C mm	d mm	E mm	G mm	€/ u.
1274500	2628 GC-160IP	160	33	23	10,5	3,5	12	19,20
1274501	2628 GC-180IP	180	36	25	11,0	4,0	14	20,74
1274502	2628 GC-200IP	200	39	27	12,0	4,5	16	22,81

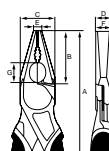

ergo®

TAH2628G- Alicate universal para trabajo en altura



Alicates universales ERGO™ con anilla de seguridad

Ref.	Código	Longitud mm	B mm	C mm	€/ u.
2400372	TAH2628G-160	160	33	23	56,75
2400373	TAH2628G-180	190	35	24	58,49
2400374	TAH2628G-200	200	39	27,9	74,65

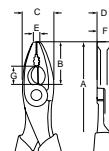

2678V - Alicate universal, aislado



Ref.	Código	A mm	B mm	C mm	d mm	E mm	G mm	€/ u.
1241900	2678V-160	160	33	23	11	6	12	41,78
1241901	2678V-180	180	36	26	13	8	13	45,55
1241902	2678V-200	200	39	28	12	9	14	48,99

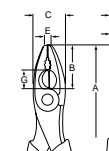

0306 - Alicate universal, aislado



Filos templados por inducción con dureza 60 HRC. Gran capacidad de corte.
Mangos aislados VDE 1.000 V.

Ref.	Código	Longitud mm	Ø alambre duro mm	Cuerda de piano mm	€/u.
1466160	03 06 160	160	3,1	2,0	27,85
1466189	03 06 180	180	3,4	2,2	30,09
1466200	03 06 200	200	3,8	2,5	33,56



Alicate universal, aislado



Filos templados por inducción con dureza 60 HRC. Gran capacidad de corte.
Mangos aislados VDE 1.000 V.

Ref.	Código	Longitud mm	€/u.
8004745	36160	160	20,56
8004746	36180	180	21,56
8004747	36200	200	24,48



SS400-Alicate universal, inoxidable



Alicates combinados de acero inoxidable y con mangos recubiertos de PVC

Ref.	Código	Longitud mm	€/u.
2400375	SS400-160	155	59,93
2400376	SS400-180	175	75,07
2400377	SS400-200	200	95,77

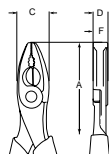

1150INOX Alicate universal, inoxidable



• Alta resistencia a la corrosión • Evita la oxidación incorrecta • Características mecánicas sobresalientes • Acero inoxidable AISI 421

Ref.	Código	L mm	€/u.
20028778	11500518	180	117,50



1153INOX 150-Alicate regulado 2 posiciones, inoxidable



Ref.	Código	L mm	€/u.
2400073	11530315	150	116,50



8201 - Alicate de agarre frontal



TwinGrip Combinación exclusiva: agarre frontal y lateral, articulación machihembrada, ajuste mediante botón pulsador. El cuerpo estilizado del alicate permite trabajar incluso en lugares de difícil acceso, con una zona de giro estrecha para conseguir unos rápidos resultados. Mordaza delantera de gran agarre con dientes resistentes y alta relación de transmisión en las puntas de la boca. Gran capacidad de agarre frontal y lateral para diámetros y anchuras de boca de 4 a 22 mm. Gran agarre frontal de piezas de trabajo planas mediante un sistema de tres puntos. Para agarrar, apretar y aflojar tornillos con las cabezas y roscas desgastadas. Articulación deslizante con cinco posiciones de ajuste con botón pulsador para un ajuste preciso de la capacidad de agarre. El retén protector reduce el riesgo de que el usuario se pellizque los dedos. Resistente y duradero gracias a la robusta articulación machihembrada. - Posiciones de ajuste: 5 - Capacidad de trabajo para tubos (diámetro): Ø 5/32 - 7/8in - Capacidad de trabajo para tubos (diámetro): Ø 4 - 22mm - Capacidad de trabajo para tuercas (caras planas): 4 - 22mm - Capacidad de trabajo para tuercas (caras planas): 5/32 - 7/8in



Ref.	Código	Longitud mm	Para tubos Ø mm	Para tubos Ø"	€/ u.
2400045	82 01 200	200	4-22	5/32-7/8	25,96

2612 - Alicate de montaje "boca cigüeña"



Acero eléctrico al cromo vanadio, forjado y templado al aceite. Puntas de presión elásticas y muy resistentes. Mangos con fundas bicomponentes.

Ref.	Código	Alambre duro	Longitud mm	€/ u.
1232200	26 12 200	2,2	200	29,02
1232201	26 22 200	2,2	200	32,49



2420 G - Alicate boca plana



ISO 5745

Ref.	Código	A mm	B mm	C mm	d mm	E mm	€/ u.
1274550	2420 G-125	125	23	16	7	2	26,36
1274551	2421 G-140IP	140	39	14,5	8,0	2	27,16
1274552	2421 G-160 IP	160	49	16,5	8,5	3	29,90
1274553	2421 G-180 IP	180	64	17,0	8,5	3	36,08

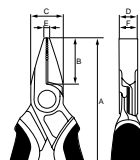

ergo®

2001 - Alicate de presión con bocas planas



Acero eléctrico al cromo vanadio, forjado y templado al aceite. Bocas cortas, planas y anchas. Superficie de las bocas rayadas. Mangos recubiertos con plástico.

Ref.	Código	Longitud mm	€/ u.
1461140	20 01 140	140	16,01
1461160	20 01 160	160	16,73



2421D - Alicate boca plana



ISO 5745

Ref.	Código	A mm	B mm	C mm	d mm	E mm	€/ u.
1232250	2421 D-140IP	140	39	14.5	8.0	2	22,81
1232251	2421 D-160IP	160	49	16.5	8.5	3	25,14
1232252	2421 D-180IP	180	64	17.0	8.5	3	29,99

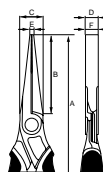

2521G - Alicate boca redonda



ISO 5745

Ref.	Código	A mm	B mm	C mm	d mm	E mm	€/ u.
1274600	2521 G-140	140	37	16	7	3.0	27,65
1274601	2521 G-160 IP	160	42	16	7	3.0	28,59

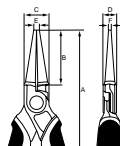

ergo®

Alicate boca semiredonda



Cabeza cromada, con mordaza larga redonda.

Ref.	Código	Longitud mm	€/ u.
8004748	61200	200	20,48



Alicate boca de cigüeña, recto



Cabeza pulida, mangos con fundas bicomponente.

Ref.	Código	Longitud mm	€/ u.
8004749	25160	160	18,46



2616 - Alicate de montaje "boca cigüeña", aislado



Acero eléctrico al cromo vanadio, forjado y templado al aceite. Puntas de presión elásticas y muy resistentes. Mangos aislados VDE 1.000 V.

Ref.	Código	Alambre duro mm	Longitud mm	€/ u.
1481290	26 16 200	2,2	200	38,10



2421V - Alicate boca plana, aislado



Ref.	Código	A mm	B mm	C mm	d mm	E mm	€/ u.
1241000	2421V-160	160	49	16.5	8.5	3	38,70

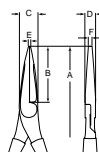

2521V - Alicate boca redonda, aislado



Ref.	Código	A mm	B mm	C mm	d mm	E mm	€/ u.
1241100	2521V-160	160	42	16	7	3.0	39,32

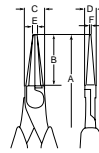

2427D - Alicate boca semiredonda, punta curva



ISO 5745.

Ref.	Código	A mm	B mm	C mm	d mm	E mm	G mm	€/ u.
1232550	2427 D-160	160	46	17	9	2	12	27,01
1232551	2427 D-200	200	10	17	9	2	12	29,20

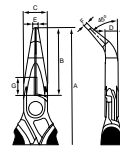

2430G - Alicate boca semiredonda, punta recta



ISO 5745.

Ref.	Código	A mm	B mm	C mm	d mm	E mm	G mm	€/ u.
1274650	2430 G-140 IP	140	39	15	8	2.5	12	26,41
1274651	2430 G-160 IP	160	49	16	8	3.0	12	27,91
1274652	2430 G-200 IP	200	72	17	9	4.0	12	32,13

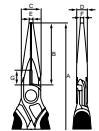

ergo®

SS406- Alicate boca semiredonda, inoxidable



Alicates de boca semirredonda y de acero inoxidable con mangos recubiertos de PVC

Ref.	Código	Longitud mm	€/ u.
2400378	SS406-160	160	64,71
2400379	SS406-200	200	74,68

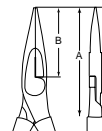

2502 - Alicate de montaje con filos de corte



Acero eléctrico al cromo vanadio, forjado y templado al aceite. Para trabajos de agarre y corte de precisión. Bocas semi-redondas. Mangos con fundas bicomponentes.

Ref.	Código	Longitud mm	Ø alambre duro mm	€/ u.
1462140	25 02 140	140	1,6	23,51
1462160	25 02 160	160	1,6	23,77



2430D - Alicate boca semiredonda, punta recta



ISO 5745.

Ref.	Código	A mm	B mm	C mm	d mm	E mm	G mm	€/ u.
1232450	2430 D-140 IP	140	39	15	8	2.5	12	23,30
1232451	2430 D-160 IP	160	49	16	8	3.0	12	25,13
1232452	2430 D-200 IP	200	72	17	9	4.0	12	27,33

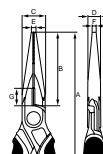

2430V - Alicate para mecánico punta recta, aislado



Ref.	Código	A mm	B mm	C mm	d mm	E mm	G mm	€ / u.
1242300	2430V-160	160	49	16	8	3.0	12	46,13
1242301	2430V-200	200	72	17	9	4.0	12	46,45

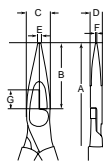

1102 - Alicate pelacables



Alicate pelacables para cables con conductores finos unitarios y múltiples con aislamiento de plástico y goma. Mangos con fundas bicomponentes.

Ref.	Código	Longitud mm	Capacidad mm2	€ / u.
1232900	11 02 160	160	10	26,16



2223G - Alicate pelacables



Ref.	Código	A mm	B mm	C mm	d mm	G mm	€ / u.
1274750	2223 G-150	150	46	15	8	8	28,61

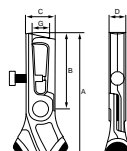

2223-D - Alicate pelacables PVC



Ref.	Código	A mm	B mm	C mm	d mm	G mm	€ / u.
1274800	2223 D-150	150	46	15	8	8	29,12

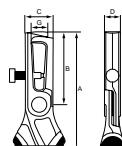

2223V - Alicate pelacables, aislado



Ref.	Código	A mm	B mm	C mm	d mm	G mm	€ / u.
1242000	2223V-160	167	46	15	8	8	52,01

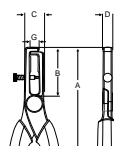

1106 - Alicate pelacables, aislado



Alicate pelacables para cables con conductores finos unitarios y multihilo con aislamiento de plástico y goma. Mangos aislados VDE 1.000 V.

Ref.	Código	Longitud mm	Capacidad mm2	€ / u.
1476160	11 06 160	160	10,0	35,04



1240 - Alicate pelacables autoajustable



Se adaptan automáticamente a los diferentes tipos de sección de cable, evitando que se dañe el conductor.

Ref.	Código	Longitud mm	Capacidad mm ²	€/ u.
1233100	12 40 200	200	0,03 - 10	78,03



1252- Alicate pelacables



Pelacables autoajustable precistrip. Pelado simple y preciso de cables redondos con un rango de capacidad de 0,08 a 16mm². Las abrazaderas de sujeción metálicas acanaladas semicirculares, proporcionan un agarre preciso y resistente. Corte exacto gracias a la cuchilla de pelado parabólica. Corta cables incluido con capacidad de 0,08 a 16mm². Con anilla de fijación incluida para poder atar a los sistema anti caída. La ruleta de ajuste permite poder modificar la capacidad de pelado en función de la fureza del cable.

Ref.	Código	Capacidad de pelado cable coaxial mm	€/ u.
21062002	12 52 195	0,08 - 716	110,77



9751 - Alicate para entallar terminales “Western”



Avance paralelo de las mordazas. Sistema de bloqueo. Con dispositivo adicional para pelar cables redondos.

Ref.	Código	Longitud mm	Capacidad entallaje mm	€/ u.
1465110	97 51 10	190	RJ 11 / 12 / 45	34,63



9733 - Alicate para entallar “Multicrimp”



Juego de alicate más cargador de 5 mordazas intercambiables.

Ref.	Código	Longitud mm	Capacidad entallaje mm	€/ u.
1463302	97 33 02	250	Según mordaza	313,75



9721 - Alicate para entallar terminales



Para cortar, pelar cables y entallar cables. Con perforaciones para cortar pasadores roscados de cobre y latón.

Ref.	Código	Longitud mm	Capacidad entallaje mm	€/ u.
1461215	97 21 215	230	0,75 - 6,0	24,74
1461216	97 21 215 B	230	0,5 - 2,5	26,42
1461217	97 21 215 C	230	0,5 - 6,0	26,01



3419 - Alicate pelacable autoajustable



Ref.	Código	Capacidad mm	€/ u.
1274851	3419 B	3-16	119,31



9753 - Alicate para entallar terminales



Cabezal para crimpar libremente giratorio de 360°, con 8 posiciones de enclavamiento. Perfil cuadrado para crimpar, elevado rango de capacidad de 0,14 hasta 16 mm². Es posible crimpar punteras huecas desde prácticamente todas las posiciones de trabajo. El alicate para crimpar se ajusta automáticamente a las diferentes secciones. Abertura para crimpar accesible desde ambos lados, las punteras huecas extra largas pueden empujarse adicionalmente. Es posible crimpar punteras huecas Twin de hasta 2 x 6 mm². Proceso de crimpado de gran calidad gracias al sistema de bloqueo con mecanismo de liberación automática. Herramienta ligera y manejable, la fuerza manual se multiplica mediante el mecanismo de palanca articulada. - Gama de aplicación: Punteras huecas - Capacidad milímetros cuadrados: 0,14 - 16mm² - AWG: 26 - 6 - Núm. de posiciones de crimpaje: 1



Ref.	Código	Capacidad punteras huecas mm ²	AWG	* pos crimpaje	€/ u.
2400047	97 53 18	0,14-16	12-6	1	204,66

9755 - Alicate para entallar terminales



Alicate autoajustable para crimpar punteras huecas Menor anchura del mango. Para un crimpado de punteras huecas conforme a la norma DIN 46228 partes 1 + 4. Ajuste automático al tamaño deseado de la puntera. Proceso de crimpado de gran calidad gracias al sistema de bloqueo con mecanismo de liberación automática. Estas herramientas han sido calibradas con precisión en fábrica. Alta transmisión de fuerza gracias a la palanca acodada para reducir fatiga en el trabajo. Muy confortable dada la forma de su mango y su reducido peso. Crimpado en cuadradillo ahora también para punteras huecas hasta 16 mm². Prensado de cuadradillo para áreas de contacto óptimas en conectores. Especialmente apto para todas las punteras huecas Twin de hasta 2 x 4 mm² o 2 x AWG 12. - Gama de aplicación: Punteras huecas - Capacidad milímetros cuadrados: 0,08 - 10 / 16mm² - Núm. de posiciones de crimpaje: 1 - AWG: 28 - 6



Ref.	Código	Capacidad punteras huecas mm ²	AWG	* pos crimpaje	€/ u.
2400048	97 55 04	2 x 4	2x12	1	190,64

9753 - Alicate para entallar terminales



Alicates automáticos para crimpar punteras huecas. Ahora con mayor capacidad de crimpado: crimpado sencillo de punteras huecas individuales de hasta 16 mm² y punteras Twin de hasta 2 x 10 mm². Crimpado hexagonal para punteras huecas, especialmente en conexiones de difícil acceso

Ref.	Código	Capacidad punteras huecas mm ²	AWG	* pos crimpaje	€/ u.
2400049	97 53 14	0,14-16	25-6	1	193,39



1396 - Alicate para instaladores eléctricos, aislado



Para sujetar material plano y redondo, doblar, desbarbar, cortacables, pelacables y entallaje de 0,5 a 2,5 mm². 5 alicates en 1! Mangos aislados VDE 1.000 V.

Ref.	Código	Longitud mm	Capacidad mm ²	€/ u.
1476200	13 96 200	200	50,0	68,08



21HDD - IP - Alicate corte diagonal



ISO 5749. Alicate de corte diagonal "Heavy Duty". Acabado: Pavonado, tratamiento anticorrosión. Material: Aleación de acero de alto rendimiento, mango monomaterial de polipropileno. Filo de corte templado por inducción. Capacidad de corte extrafuerte. Remache que proporciona un funcionamiento excelente y una alineación precisa de los filos de corte. Se ha reducido la distancia del remache al centro del filo de corte: mayor acción de palanca y capacidad de corte. Cabeza de corte redondeada que mejora la accesibilidad en espacios reducidos.

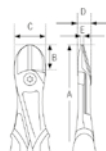

Ref.	Código	A mm	Ø alambre duro mm	Ø cuerda de piano mm	B mm	C mm	E mm	Peso grs.	€/ u.
1470140	21HDD-140IP	140	2,2	2,2	15,9	21,0	2,0	110	21,34
1470160	21HDD-160IP	160	2,5	2,5	18,0	23,0	2,1	150	21,97
1470180	21HDD-180IP	180	2,8	2,8	19,8	25,0	2,3	210	24,13
1470200	21HDD-200IP	200	3,2	3,0	22,4	27,0	2,8	270	26,57

7001 - Alicate corte diagonal



Filos de corte con dureza de 62 HRC. Cabeza esbelta y corte preciso. Gran capacidad de corte y manejo cconfortable. Mangos recubiertos con plástico.

Ref.	Código	Longitud mm	Alambre duro	€/ u.
1471125	70 01 125	125	1,5	19,99
1471140	70 01 140	140	1,8	19,99
1471160	70 01 160	160	2,0	20,35
1471180	70 01 180	180	2,5	22,19



2101 GC - IP - Alicate corte diagonal



ISO 5749. Diseñado según los procesos científicos ERGO™. Acabado: niquelado, tratamiento anticorrosión. Material: aleación de acero de alto rendimiento. Mangos ERGO™ bi-componente, superficie termoplástica de polipropileno para un mejor agarre. Filo de corte templado por inducción. Filo de corte progresivo: el radio de corte progresa a lo largo del filo para cortar material duro como cuerda de piano cerca del remache y materiales blandos como el cobre y cable aislado en la punta. Remache que proporciona un funcionamiento excelente y una alineación precisa de los filos de corte. Se ha reducido la distancia del remache al centro del filo de corte: mayor acción de palanca y capacidad de corte. Bocas redondeadas que mejoran la accesibilidad en espacios reducidos. Lleva incorporado un innovador muelle retraíble patentado.

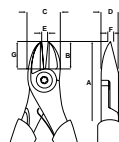

Ref.	Código	A mm	Ø alambre duro mm	Ø cuerda de piano mm	Ø corte	B mm	d mm	E mm	Peso grs.	€/ u.
1460125	2101GC-125IP	125	3,5	1,8	1,6	14,2	8,0	1,0	90	22,78
1460140	2101GC-140IP	140	3,7	2,0	1,8	15,9	8,0	1,5	120	22,90
1460160	2101GC-160IP	160	3,8	2,5	2,0	17,5	9,0	2,0	170	23,85
1460180	2101GC-180IP	180	4,0	2,7	2,3	19,4	10,0	2,0	230	25,99

7402 - Alicate de corte diagonal extrafuerte



Efecto palanca optimizado. Filos de corte con dureza de 64 HRC. Gran capacidad de corte. Hasta un 20% menos de esfuerzo. Mangos con fundas bicomponentes.

Ref.	Código	Longitud mm	Ø alambre duro mm	Cuerda de piano mm	€/ u.
1481255	74 02 180	180	2,7	2,2	32,79
1481256	74 02 200	200	3,0	2,5	34,94
1481257	74 02 250	250	3,5	3,0	42,23



7002 - Alicate corte diagonal



Filos de corte con dureza de 62 HRC. Cabeza esbelta y corte preciso. Gran capacidad de corte y manejo confortable. Mangos con fundas bicomponentes.

Ref.	Código	Longitud mm	Ø alambre duro mm	€/ u.
1472125	70 02 125	125	1,5	24,38
1472140	70 02 140	140	1,8	24,79
1472160	70 02 160	160	2,0	25,60
1472180	70 02 180	180	2,5	27,23



TAH2101G - Alicate de corte diagonal para trabajos en altura



Alicates de corte diagonal ERGO™ con anilla de seguridad

Ref.	Código	Longitud mm	B mm	C mm	€/ u.
2400380	TAH2101G-180	185	23	21	62,69
2400381	TAH21HDG-200	210	24	27	64,02



21HDG - IP - Alicate corte diagonal



ISO 5749. Alicate de corte diagonal "Heavy Duty". Diseñado según los procesos científicos ERGO™. Acabado: Pavonado, tratamiento anticorrosión. Material: Aleación de acero de alto rendimiento, mangos ERGO™ bi-componente, superficie termoplástica en polipropileno que ofrece mejor agarre. Filo de corte templado por inducción. Capacidad de corte extrafuerte. Remache que proporciona un funcionamiento excelente y una alineación precisa de los filos de corte. Se ha reducido la distancia del remache al centro del filo de corte: mayor acción de palanca y capacidad de corte. Cabeza de corte redondeada que mejora la accesibilidad en espacios reducidos. Lleva incorporado un muelle retraíble patentado.

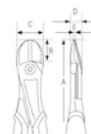

Ref.	Código	A mm	Ø alambre duro mm	Ø cuerda de piano mm	B mm	C mm	E mm	Peso grs.	€/ u.
1480140	21HDG-140IP	140	2,2	2,2	15,9	21,0	2,0	110	25,40
1480160	21HDG-160IP	160	2,5	2,5	18,0	23,0	2,1	150	26,11

Ref.	Código	A mm	Ø alambre duro mm	Ø cuerda de piano mm	B mm	C mm	E mm	Peso grs.	€/ u.
1480180	21HDG-180IP	180	2,8	2,8	19,8	25,0	2,3	210	28,77
1480200	21HDG-200IP	200	3,2	3,0	22,4	27,0	2,8	270	30,71

7401 - Alicate de corte diagonal extrafuerte



Efecto palanca optimizado. Filos de corte con dureza de 64 HRC. Gran capacidad de corte. Hasta un 20% menos de esfuerzo. Mangos recubiertos de plástico.

Ref.	Código	Longitud mm	Ø alambre duro mm	Cuerda de piano mm	€/ u.
1481180	74 01 180	180	2,7	2,2	26,98
1481200	74 01 200	200	3,0	2,5	29,73
1481250	74 01 250	250	3,5	3,0	37,64



Alicate de corte diagonal extrafuerte



Cabeza pulida, mango bicomponente.

Ref.	Código	Longitud mm	Ø Alambre duro mm	Ø Cuerda de piano mm	€/ u.
8004754	74180	180	2,7	2,3	28,30
8004755	74200	200	3	2,5	31,50



1082INOX Alicate de corte diagonal, inoxidable



• Alta resistencia a la corrosión • Evita la oxidación incorrecta • Características mecánicas sobresalientes • Acero inoxidable AISI 420

Ref.	Código	L mm	€/ u.
20028665	10820350	160	119,50



7372 - Alicate corte diagonal de alto rendimiento "TwinForce"



Máxima capacidad de corte. Corta incluso fleje de acero. Hasta un 50% menos de esfuerzo. Reduce la fatiga y las lesiones. Mangos con fundas bicomponentes.

Ref.	Código	Cuerda de piano mm	Longitud mm	Ø alambre duro mm	€/ u.
1482180	73 72 180	3,0	180	3,2	71,81



2101PG - Alicate corte diagonal, para plástico



ISO 5749.

Ref.	Código	A mm	B mm	C mm	d mm	E mm	G mm	€/ u.
1275050	2101PG-160	160	18	21,5	10	2,0	18	53,99

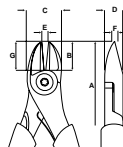

7302 - Alicate corte diagonal compactos "X-CUT"



Gran capacidad de corte. Corta desde finos hilos hasta cuerda de piano. Efecto palanca optimizado. Articulación machihembrada. Mangos con fundas bicomponentes.

Ref.	Código	Cuerda de piano mm	Longitud mm	Ø alambre duro mm	€/ u.
1482160	73 02 160	2,2	160	2,7	43,76



SS402-Alicate corte diagonal, inoxidable



Alicates de corte diagonal de acero inoxidable con mangos recubiertos de PVC

Ref.	Código	Longitud mm	€/ u.
2400382	SS402-160	150	64,32
2400383	SS402-200	195	70,02

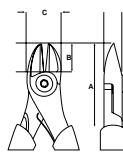

2171V - Alicate corte diagonal, aislado



Ref.	Código	A mm	B mm	C mm	d mm	E mm	G mm	€/ u.
1241200	2171V-160	160	20	25	12	3	20	41,49
1241201	2171V-180	180	22	24	12	2.0	22	44,49



7006 - Alicate corte diagonal, aislado



Filos de corte con dureza de 62 HRC. Cabeza esbelta y corte preciso. Gran capacidad de corte y manejo comfortable. Mangos aislados VDE 1.000 V.

Ref.	Código	Longitud mm	Ø alambre duro mm	€/ u.
1486160	70 06 160	160	2,0	34,68
1486180	70 06 180	180	2,5	37,13



Alicate de corte diagonal, aislado



Cabeza cromada, mangos con fundas bicomponente.

Ref.	Código	Longitud mm	Ø Alambre semiduro mm	Ø Alambre duro mm	€/ u.
8004752	76160	160	2,8	2	17,70
8004753	76180	180	3	2,5	20,02



7306 - Alicate corte diagonal compactos "X-CUT", aislado



Gran capacidad de corte. Corta desde finos hilos hasta cuerda de piano. Efecto palanca optimizado. Articulación machihembrada. Mangos aislados VDE 1.000 V

Ref.	Código	Cuerda de piano mm	Longitud mm	Ø alambre duro mm	€/ u.
1496160	73 06 160	2,2	160	2,7	52,43



2145PD - Alicate corte oblicuo a 45-90° para plástico



Ref.	Código	A mm	B mm	C mm	d mm	E mm	G mm	€/ u.
1275100	2145PD-150	150	21	15	11	17	18	50,54
1275101	2190PD-150	150	11.5	15	11	-	20	53,43

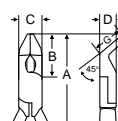

1520G - Alicate corte gran capacidad, acción palanca



Ref.	Código	A mm	B mm	C mm	d mm	E mm	€/ u.
1275150	1520 G	210	16	33,5	17,1	8	38,87

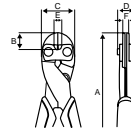

1520 D - Alicate corte gran capacidad, acción palanca



Ref.	Código	A mm	B mm	C mm	d mm	E mm	€/ u.
1275200	1520 D	210	16	33,5	17,1	8	43,84

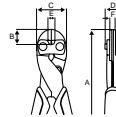

527 D - Alicate corte frontal, cuerpo reforzado



ISO 5748.

Ref.	Código	A mm	B mm	C mm	d mm	E mm	G mm	€/ u.
1233960	527 D-160	160	7	26,5	11	3,0	21	26,42
1233961	527 D-200	200	7	35	13	3,0	29,5	31,56

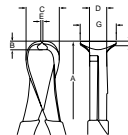

6701 - Alicate de fuerza corte frontal



Gran capacidad de corte debido a la óptima coordinación del ángulo de corte y la transmisión de ratio. Mangos recubiertos con plástico.

Ref.	Código	Longitud mm	Ø alambre duro mm	Cuerda de piano mm	€/ u.
1491160	67 01 160	160	2,5	2,0	33,15
1491200	67 01 200	200	3,0	2,5	41,00



9531 - Cortacables de carraca



Cuchillas de corte templadas y afiladas con gran precisión. Corte limpio sin deformaciones ni aplastamientos. Con carraca para un corte rápido y fácil. Mangos con fundas bicomponentes.

Ref.	Código	Longitud mm	Capacidad Ø mm	€/ u.
1491280	95 31 280	280	52,0	328,39



9561 - Cortacables para cable trenzado



Efecto multiplicación para un corte con muy poco esfuerzo. El cable no se deshila. 2 perfiles de prensado para Bowden y puntas. Mangos de PVC.

Ref.	Código	Longitud mm	Capacidad Ø mm	€/ u.
1275300	95 61 190	190	7 / 5 / 4 / 2,5	50,54



9512 - Cortacables



Cuchillas de corte templadas y afiladas con gran precisión. Corte limpio sin deformaciones ni aplastamientos. Mangos con fundas bicomponentes.

Ref.	Código	Longitud mm	Capacidad Ø mm	€ / u.
1275350	95 12 165	165	15,0	37,69
1275351	95 12 200	200	20,0	61,30



9562 - Cortacables



Cortacables para cable trenzado Para cables trenzados de gran resistencia de hasta Ø 4 mm y cables de hasta Ø 6 mm: corte ligero y de alta precisión gracias a su singular diseño con patente en trámite. Tamaño compacto, peso ligero, alta potencia. Diseñado para un uso intensivo: particularmente duradero y ligero con tan solo 172 g de peso. Compacto, ligero y potente. Hasta un 30 % menos de esfuerzo en comparación con los cortacables para cable trenzado de la misma longitud. Articulación pasante de doble alojamiento para alta estabilidad. Filos de corte templados adicionalmente por inducción. Dureza aprox. de los filos de corte 64 HRC. Trabajo confortable gracias al muelle de apertura. Protegido mediante trinquete durante el transporte. para cables trenzados de Ø de 4,00 / 1960 Nmm². - Capacidad de corte cable de cobre, multifilar (diámetro): Ø 6,0mm - Valor de corte cable metálico (diámetro): Ø 4,0mm

Ref.	Código	Longitud mm	Capacidad Ø mm	€ / u.
2400050	95 62 160	160	6	40,44



9516 - Alicate cortacables, aislado



Cuchillas de corte templadas y afiladas con gran precisión. Corte limpio sin deformaciones ni aplastamientos. Mangos aislados VDE 1.000 V.

Ref.	Código	Longitud mm	Capacidad Ø mm	€ / u.
1496165	95 16 165	165	15	54,47
1496200	95 16 200	200	20	69,31



2250V - Alicate cortacables eléctricos, aislado



Ref.	Código	A mm	B mm	C mm	d mm	F mm	€ / u.
1241400	2250V-170	170	17	28	10	9.0	109,12
1241401	2250V-230	230	22	35	13	12.0	127,15

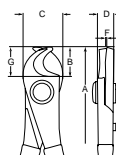

7101 - Alicate corta-alambres "COBOLT"



Filos templados por inducción con dureza de 64 HRC. Gran capacidad corte. Corta bulones, varillas, remaches y clavos. Mangos recubiertos de plástico.

Ref.	Código	Longitud mm	Ø alambre duro mm	Cuerda de piano mm	€ / u.
1234750	71 01 200	200	4	3,6	43,81



7102 - Alicate corta-alambres "COBOLT"



Cortavarillas Cobolt S con muesca en el filo de corte. Multiplica por 25 la fuerza ejercida en los mangos. Corta bulones, clavos, remaches etc hasta 4,8mm. Incluso corta cuerda de piano hasta 3,3 mm. La muesca en el filo de corte evita que el material a cortar, se desplace hacia arriba en el momento del corte.



Ref.	Código	Longitud mm	Ø alambre duro mm	Cuerda de piano mm	€/ u.
21062000	71 31 160	160	5,3	3,3	39,88

2804 - Cortacables



Ref.	Código	A mm	C mm	d mm	Ø 1 mm	Ø 2 mm	€/ u.
1235450	2804	250	50	15	16	32	436,26
1235451	2805-280	280	77	15	-	52	510,21

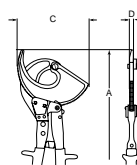

9536 - Alicate cortacables de carraca, aislado



Cuchillas de corte templadas y afiladas con gran precisión. Corte limpio sin deformaciones ni aplastamientos. Con carraca para un corte rápido y fácil. Mangos aislados VDE 1.000 V.



Ref.	Código	Longitud mm	Capacidad Ø mm	€/ u.
1476280	95 36 280	280	52,0	366,79

1695 - Pelacables multifuncional Ergostrip



Para pelar con rapidez y precisión todo tipo de cables convencionales redondos, cables antihumedad, NYM y coaxiales. Dispositivo de pelado para las secciones 0,2 / 0,3 / 0,8 / 1,5 / 2,5 / 4 mm². Con cuchilla incorporada para poder pelar mangueras longitudinalmente



Ref.	Código	Capacidad de pelado cable redondo mm	Capacidad de pelado cable de datos mm ²	Capacidad de pelado cable coaxial mm	Peso kg	€/ u.
8000359	16 95 01 SB	8 - 13	0,2 - 4,0	4,8 - 7,5	0,4	45,29

1272-NEXSTRIP multifunción



Herramienta multifunción para electricistas. Pelacables con 3 funciones; pelado hasta 10 mm², crimpado de 4 mm² y 2 x 2,5 mm², y corte de 10 mm². Pelado preciso para trabajos repetitivos: adaptación automática al diámetro del cable y garantía de longitud de pelado gracias al tope ajustable. Crimpado perfecto y rápido de punteras huecas. El sistema de bloqueo garantiza la presión de crimpado adecuada



Ref.	Código	Longitud mm	€/ u.
2400051	12 72 190	190	144,02

Alicate pelacables



Se adaptan automáticamente a los diferentes tipos de sección de cable, evitando que se dañe el conductor.

Ref.	Código	Sección de conductor mm ²	€ / u.
8004756	12180	0,2-6,00	29,40



Alicate para arandelas interiores rectos



Cabeza pulida. DIN 5256 C. Mangos con fundas de plástico.

Ref.	Código	Longitud mm	Capacidad Ø mm	€ / u.
8005540	44J1	140	12-25	11,76
8005541	44J2	180	19-60	12,44



4411 - Alicate recto para arandelas interiores



Puntas mecanizadas antideslizantes de gran precisión. Mangos recubiertos con plástico.

Ref.	Código	Longitud mm	Capacidad Ø mm	€ / u.
1235500	44 11 J0	140	8 - 13	15,71
1235501	44 11 J1	140	12 - 25	15,71
1235502	44 11 J2	180	19 - 60	16,78
1235503	44 11 J3	225	40 - 100	19,23
1235504	44 11 J4	320	85 - 140	32,08



4421 - Alicate curvo para arandelas interiores



Puntas mecanizadas antideslizantes de gran precisión. Curvos a 90°. Mangos recubiertos con plástico.

Ref.	Código	Longitud mm	Capacidad Ø mm	€ / u.
1235600	44 21 J01	130	8 - 13	17,85
1235601	44 21 J11	130	12 - 25	17,85
1235602	44 21 J21	170	19 - 60	18,11
1235603	44 21 J31	215	40 - 100	20,35
1235604	44 21 J41	300	85 - 140	34,27



2800 - Alicate para arandelas interior punta recta



DIN 5256.

Ref.	Código	A mm	B mm	C mm	Capacidad mm	d mm	€ / u.
1235950	2800-140	140	38	18	8-13	0.8	19,69
1235951	2800-150	150	38	20	12-25	10	19,69
1235952	2800-180	180	57	23	19-60	10	22,48
1235953	2800-225	225	69	28	40-100	12	28,30
1235954	2800-300	310	95	33	85-165	14	38,80

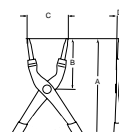

2890 - Alicate para arandelas interior punta curva



DIN 5256.

Ref.	Código	A mm	B mm	C mm	Capacidad mm	d mm	€/ u.
1236050	2890-125	127	38	17	8-15	9	17,07
1236051	2890-140	140	38	19	12-25	10	20,00
1236052	2890-180	180	57	23	19-60	12	23,20
1236053	2890-210	210	59	27	40-100	14	29,20
1236054	2890-300	289	95	33	85-165	14	43,62

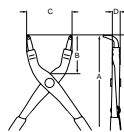

Alicate para arandelas interiores acodados



Cabeza pulida. Mangos con fundas de plástico. DIN 5256 D. Puntas acodadas 90°.

Ref.	Código	Longitud mm	Capacidad Ø mm	€/ u.
8005542	44J11	140	12-25	12,44
8005543	44J21	180	19-60	13,08



4611 - Alicate recto para arandelas exteriores



Puntas mecanizadas antideslizantes de gran precisión. Mangos recubiertos con plástico.

Ref.	Código	Longitud mm	Capacidad Ø mm	€/ u.
1235805	46 11 A0	140	3-10	18,11
1235801	46 11 A1	140	10-25	17,29
1235802	46 11 A2	180	19-60	19,07
1235803	46 11 A3	210	40-100	20,60
1235804	46 11 A4	320	85-140	36,06



Alicate para arandelas exteriores rectos



Cabeza pulida. DIN 5254 A. Mangos con fundas de plástico. Muelle de apertura.

Ref.	Código	Longitud mm	Capacidad Ø mm	€/ u.
8005544	46A1	140	12-25	14,42
8005545	46A2	180	19-60	15,26



4621 - Alicate curvo para arandelas exteriores



Puntas mecanizadas antideslizantes de gran precisión. Curvos a 90°. Mangos recubiertos con plástico.

Ref.	Código	Longitud mm	Capacidad Ø mm	€/ u.
1236105	46 21 A01	125	3-10	19,84
1236101	46 21 A11	125	10-25	18,82
1236102	46 21 A21	170	19-60	20,60
1236103	46 21 A31	200	40-100	22,80
1236104	46 21 A41	300	85-140	39,12



Alicate para arandelas exterior punta recta



Cabeza pulida. Mangos con fundas de plástico. DIN 5254 B. Muelle de apertura. Puntas acodadas 90°.

Ref.	Código	Longitud mm	Capacidad Ø mm	€/ u.
8005546	46A11	140	12-25	15,12
8005547	46A21	180	19-60	16,02

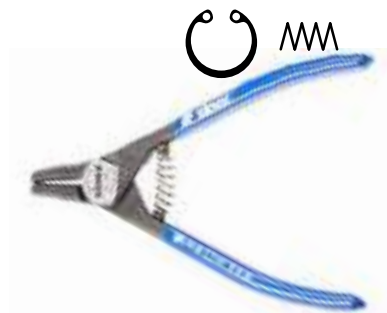

2990 - Alicate para arandelas exterior punta recta



DIN 5256.

Ref.	Código	A mm	B mm	C mm	Capacidad mm	d mm	€/ u.
1275450	2990-125	127	38	18	3-10	9	21,51
1275451	2990-140	140	38	20	10-25	10	21,51
1275452	2990-180	180	57	22	19-60	10	24,17
1275453	2990-200	200	69	27	40-100	14	29,20
1275454	2990-300	289	95	35	85-165	11	43,05

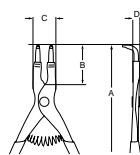

2900 - Alicate para arandelas exterior punta recta



DIN 5256.

Ref.	Código	A mm	B mm	C mm	Capacidad mm	d mm	€/ u.
1275400	2900-140	140	38	18	3-10	9	21,00
1275401	2900-150	150	38	20	10-25	10	21,00
1275402	2900-180	180	57	23	19-60	11	22,92
1275403	2900-215	215	69	31	40-100	12	28,30
1275404	2900-300	295	95	35	85-165	14	44,22

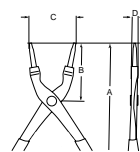

4130 - Alicate corte lateral



ISO 5749.

Ref.	Código	A mm	B mm	C mm	d mm	E mm	G mm	€/ u.
1275500	4130	120	9	11	6.8	0.5	10	47,87
1275501	4131	120	9	11	6.8	0.5	10	47,87

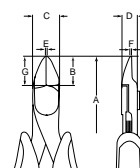

7803 - Alicate para electrónica "Super Knips"



Para los trabajos de corte más finos. Puntas y filos de corte de gran precisión. Sin bisel para un corte a ras. Mangos con fundas bicomponentes.

Ref.	Código	Longitud mm	Capacidad Ø mm	€/ u.
1481260	78 03 125	125	1,0	22,64



7806 - Alicate para electrónica "Super Knips", aislado



Alicate de precisión con certificación VDE para trabajos de corte sensibles, p. ej. en electrónica y mecánica de precisión. Completa su gama VDE. Filos rectificadas muy afilados sin bisel. Corte de cizalla con micro desplazamiento controlado del canto de corte para un corte ultrapreciso incluso de hilos finísimos y una larga vida útil. Las puntas de configuración precisa cortan también alambres colindantes a partir de Ø 0,2 mm. Articulación con remache de acero afinado. Movimiento extremadamente suave que evita la fatiga del operario. Con muelle y limitador de apertura. Dureza aprox. de los filos de corte 54 HRC. - Capacidad de corte alambre semiduro (diámetro): Ø 1,0mm - Capacidad de corte alambre blando (diámetro): Ø 0,2 - 1,6mm - Longitud de boca (B): 9mm - Grosor de boca (articulación) (D): 7,5mm - Anchura de la cabeza (A): 13,5mm



Ref.	Código	Longitud mm	Capacidad Ø mm	€/ u.
2400052	78 06 125	125	1,0	29,53

4239 - Alicate corte oblicuo 45°



ISO 5748.

Ref.	Código	A mm	B mm	C mm	d mm	E mm	G mm	€/ u.
1275600	4239	129	19	9	7	3.0	5.5	64,54

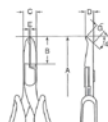

4430 - Alicate boca plana



ISO 5748.

Ref.	Código	A mm	B mm	C mm	d mm	E mm	€/ u.
1275650	4430	135	26	9	7	1.0	41,08

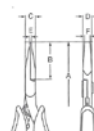

4830 - Alicate boca plana semiredonda



ISO 5748.

Ref.	Código	A mm	B mm	C mm	d mm	E mm	€/ u.
1275700	4830	135	25	9	7	1.0	42,75
1275701	4831	135	25	9	7	1.0	45,46

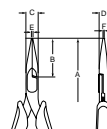

4833 - Alicata boca semiredonda y punta curvada 60°



ISO 5745.

Ref.	Código	A mm	B mm	C mm	d mm	E mm	€/u.
1275750	4833	130	23	9	7	1.0	47,00

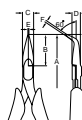

4530 - Alicata boca redonda



ISO 5745.

Ref.	Código	A mm	B mm	C mm	d mm	E mm	€/u.
1275800	4530	135	22	9	7	1.6	43,35

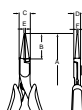

1778MT-Herramienta multifunción



La herramienta multifunciones BETA se diferencia de otras similares presentes en comercio por las características que definen su origen BETA: alicates de calidad incomparable, utilización de materiales rebuscados y elevado contenido tecnológico. La presencia de 11 puntas, para tornillos con huella Phillips®, Torx®, Pozidriv®, hexagonal y de corte, hace que esta herramienta resulte ideal en cualquier medio y condición de trabajo, del camping a la náutica, de la caza al bricolaje.

Ref.	Código	Herramientas	Funciones	Puntas	€/u.
2400074	17780055	9	22	11	115,00



SC127 - Tijera electricista



Cromada. Anillas plastificadas.

Ref.	Código	Longitud mm	A mm	€/u.
1236800	SC127	45	127	12,83

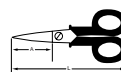

9505 - Tijera electricista



Tijeras universales con mayor ergonomía gracias a la posición recta y natural de la muñeca. Filos y dentado precisos que ofrecen un corte limpio y anti-deslizante. Adaptación a la mano: cuchillas anguladas y diseño de mango optimizado para una ergonomía mejorada. Dos áreas de crimpado para punteras huecas de 0,5 – 6 mm² y 10 – 25 mm²

Ref.	Código	Longitud mm	€/u.
2400053	95 05 20 SB	160	38,45
1481295	95 05 155 SB	160	22,08
8000006	95 05 10 SB	160	27,85



95 05 155 SB



95 05 10 SB

SC127V - Tijera electricista, aislada



Ref.	Código	Longitud mm	A mm	€ / u.
1245000	SC127V	50	130	23,79



SC150NG - Tijera electricista



Cromada. Anillas plastificadas.

Ref.	Código	Longitud mm	A mm	€ / u.
1236900	SC150NG	38	152	18,74



1128BAX Tijera electricista de efecto doble



- Patentadas - Corte de efecto doble: - esfuerzo + potencia - Diseño especial, reduce un 20% el esfuerzo - Perfil y fresa: estudiadas para agrandar los agujeros en plástico de 13 a 25 mm - Revestimiento DLC (diamond-like carbon): revestimiento innovador a base de carbono. Su elevada dureza y el bajo coeficiente de roce se deben a la presencia simultánea de carbono depositado en la superficie en forma de grafito y diamante - Alta dureza superficial de las hojas (resistencia a la abrasión y mantenimiento del afilado en el tiempo) - Bajo coeficiente de roce (fluidez y potencia de corte) - Perno excéntrico anti-ralentización - Mangos amplios con ranuras aprieta-tubos - En estuche de plástico articulado

Ref.	Código	L mm	L1 mm	mm ²	€ / u.
8005204	11280088	150	50	50	36,50



2820EF - Navaja electricista



Ref.	Código	A mm	Longitud mm	€ / u.
1237000	2820EF2	65	200	12,32

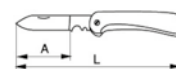

9852 - Cuchillo recto para cables, aislado



Cuchilla solidamente fijada, de acero especial templado al aceite. Mango VDE aislado a 1.000 V.

Ref.	Código	Longitud mm	€ / u.
1240930	98 52	185	16,12



KBTU-01 - Navaja doble hoja mango de aluminio



Cutter navaja sports con hoja de 75 mm/3°. Seguro para hojas. Hoja de navaja de 75 mm/3" para cortar cuerda. Mango de aluminio. Hoja y mecanismo de acero inoxidable. La hoja se bloquea cuando está totalmente abierta. Botón de desbloqueo de la hoja para mayor seguridad.

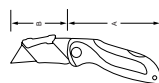

Ref.	Código	Altura mm	Anchura mm	Longitud mm	Peso grs.	€/ u.
1200345	KBTU-01	55	20	170	199	31,44

KBSK-01 - Navaja hoja fija 3 pulgadas



Hoja de 75 mm/3". Hoja y mecanismo de acero inoxidable. Dentado en la hoja para cortar cuerda. Mango de aluminio. La hoja se bloquea cuando está totalmente abierta. Botón de desbloqueo de la hoja para mayor seguridad.

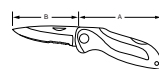

Ref.	Código	Altura mm	Anchura mm	Longitud mm	Peso grs.	€/ u.
1200346	KBSK-01	47	14	148	139	20,01

KBSU-01 - Navaja hoja intercambiable



Cutter para deporte. Cutter plegable para menor espacio. Apoyo de dedo para más confort. Mango de aluminio. La hoja se bloquea cuando está totalmente abierta. Botón de desbloqueo de la hoja para mayor seguridad.

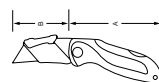

Ref.	Código	Altura mm	Anchura mm	Longitud mm	Peso grs.	€/ u.
1200347	KBSU-01	55	13	170	90	20,01

1778SOS-Cuchillo de auto socorro



Cuchillo de auto-socorro con función martillo rompecristales y corta-cinturones de seguridad - Con clip y estuche en textil

Ref.	Código	Longitud mm	Anchura mm	Hoja mm	€/ u.
2400075	17780080	205	25	85	30,00



584D - Tijera carroceros c/derecha



Ref.	Código	Longitud mm	Ø 1 mm	Ø 2 mm	€/ u.
1237100	584D	280	0.6	1.2	84,63



MR227L - Tijera carroceros c/izquierda



Ref.	Código	Longitud mm	Ø 1 mm	Ø 2 mm	€/ u.
1237200	MR227L	270	0.6	1.2	45,96



8691 - Tijera para chapa modelo MADRID



Ref.	Código	A mm	L mm	€/ u.
1237301	869102500	44	250	31,58
1237302	869103000	50	300	39,62



MA421 - Tijera articulada



Ref.	Código	Corte	Longitud mm	Ø 1 mm	Ø 2 mm	€/ u.
1237400	MA421	Recto	250	0.53	0.94	29,61
1237401	MA411	Derecha	250	0.7	1.2	29,61
1237402	MA401	Izquierda	250	0.7	1.2	29,61



MA431 - Tijera articulada de corte largo



Dureza en corte: 60-62 Hrc. Realiza cortes de hasta 75 mm. Multiuso Capacidad de corte: 1- Acero acero inoxidable. 2- Acero laminado frío.

Ref.	Código	Longitud mm	Ø 1 mm	Ø 2 mm	€/ u.
1237500	MA431	290	0.53	0.94	32,48



MA321 - Tijera articulada reforzada



Dureza en corte: 60-62 Hrc. Capacidad de corte: 1- Acero acero inoxidable. 2- Acero laminado frío.

Ref.	Código	Corte	Longitud mm	Ø 1 mm	Ø 2 mm	€/ u.
1237600	MA321	Izquierda	260	0.9	1.5	38,66
1237601	MA311	Derecha	260	0.9	1.5	38,66



MA361 - Tijera articulada reforzada, acodada



Dureza en corte: 60-62 Hrc. Capacidad de corte: 1- Acero acero inoxidable. 2- Acero laminado frío.

Ref.	Código	Corte	Longitud mm	Ø 1 mm	Ø 2 mm	€/ u.
1237700	MA361	Derecha	250	1	1.5	43,30
1237701	MA351	Izquierda	250	1	1.5	43,30



Tijera plástico



Tijera para tubería de plástico de 32mm

Ref.	Código	Descripción	€ / u.
1267300	52040	Tijera plástico 32 mm	54,95
1267301	52041	Recambio cuchilla	28,45



Tijera especial tubo plástico



Tijera para tubería de plástico de 26mm

Ref.	Código	Descripción	€ / u.
1267400	52005	Tijera especial tubo plástico 26 mm	38,95
1267401	52000	Tijera especial tubo plástico 42 mm	70,95
1267403	52010	Tijera especial tubo plástico 50 mm	100,95



9025- Corta tubos para tubos combinados



Cuchilla de repuesto en acero inoxidable para tijera para tubos de plástico de 32mm

Ref.	Código	Capacidad de pelado cable redondo mm	Longitud mm	€ / u.
21062004	90 25 185	12-25	185	60,84



9010- Corta tubos para mangueras neumáticas



Tijera para tubería de plástico de 26mm

Ref.	Código	Capacidad de pelado cable redondo mm	Longitud mm	€ / u.
21062005	90 10 185	4-20	185	60,84



9900 - Tenaza rusa para armadores



Tenaza rusa para armadores, tratamiento atramentado, color negro

Ref.	Código	Longitud mm	Ø Alambre duro mm	€ / u.
1237901	99 00 220	220	1,4	16,17
1237902	99 00 250	250	1,6	17,65
1237903	99 00 280	280	1,8	19,33
1237904	99 00 300	300	1,8	23,05



9910 - Tenaza rusa de fuerza para armadores



Tenaza rusa para armadores de fuerza, tratamiento atramentado, color negro

Ref.	Código	Longitud mm	Ø Alambre duro mm	€ / u.
1238200	99 10 300	300	2,0	29,22



9914 - Tenaza rusa de fuerza niquelada para armadores



Tenaza rusa para armadores de fuerza, cromada

Ref.	Código	Longitud mm	Ø Alambre duro mm	€/ u.
1238300	9914 300	300	2,0	32,03



6001 - Tenaza rusa



Ref.	Código	Cabeza	Longitud mm	€/ u.
1238350	6001-225	Pulida	225	16,56
1238351	6001-250	Pulida	250	17,84
1238352	6001-280	Pulida	280	21,30
1238353	6001-300	Pulida	300	22,28



Tenaza rusa



Ref.	Código	Longitud mm	Ø Alambre duro mm	€/ u.
8004761	99280	280	3,5	17,90



6005 - Tenaza carpintero



Ref.	Código	Cabeza	Longitud mm	€/ u.
1238050	6005-180	Pulida	180	18,37
1238051	6005-200	Pulida	200	19,23
1238052	6005-225	Pulida	225	21,90
1238053	6005-250	Pulida	250	26,39



2949IP - Tenaza de ajuste rápido



Ref.	Código	A mm	B mm	C mm	€/ u.
1238400	2949-190IP	193	30	32	62,31
1238401	2949-200IP	196	30	70	66,10
1238402	2949-240IP	240	62	70	69,28
1238403	2949-250IP	240	62	150	86,07



6003 - Tenaza alicatar



Ref.	Código	Características	Longitud mm	€/ u.
1200090	6003	Recta	215	18,17



6004 - Tenaza alicatar



Ref.	Código	Características	Longitud mm	€/ u.
1200091	6004	Agujeros interiores	196	18,17



8801 - Tenaza "ALLIGATOR"



Fácil acceso a la pieza gracias al diseño esbelto en la zona de la cabeza y la articulación. Mayor rendimiento y confort en comparación con tenazas convencionales para bombas de agua de la misma longitud: 9 posiciones de ajuste para un 30 % más de capacidad de agarre. Auto-retención en tuberías y tuercas, agarre perfecto a la pieza con el mínimo esfuerzo. Mordazas con dientes adicionalmente templados, dureza aprox. de los dientes 61 HRC: poco desgaste y gran seguridad en el agarre. Articulación machihembrada: gran estabilidad por la doble guía. Diseño robusto, resistente a la suciedad, indicada especialmente para trabajos en el exterior. Un retén protector evita lesiones por pellizcos. - Posiciones de ajuste: 9 - Capacidad para tubos de pulgada (diámetro): Ø 1 1/2 - Capacidad de trabajo para tuercas (caras planas): 36mm - Capacidad de trabajo para tubos (diámetro): Ø 42mm

Ref.	Código	Capacidad "	Longitud mm	Capacidad en mm	€/ u.
1491180	88 01 180	1 1/2	180	36	22,64
1491250	88 01 250	2	250	46	23,87
1491300	88 01 300	2 3/4	300	60	35,80
1491400	88 01 400	3 1/2	400	95	70,02



8721 - Tenaza "COBRA-QUICKSET"



¡Abrir completamente, cerrar y agarrar!. Ajuste rápido adicional a la pieza de trabajo mediante cierre. Combina el encaje seguro del perno de articulación con una función adicional de aproximación que facilita el trabajo en zonas estrechas y de difícil acceso. El ajuste directo a la pieza se puede realizar mediante la simple aproximación de los mangos. El perno de articulación encaja con el primer esfuerzo. A continuación, la anchura del mango de las tenazas queda fijada y solamente se podrá modificar pulsando el botón. Para volver a activar la función de desplazamiento, es necesario expulsar el perno de articulación mediante pulsación de botón y abrir las tenazas una vez completamente. - Posiciones de ajuste: 25 - Capacidad para tubos de pulgada (diámetro): Ø 2 in - Capacidad de trabajo para tuercas (caras planas): 46mm - Capacidad de trabajo para tubos (diámetro): Ø 50mm

Ref.	Código	Capacidad "	Longitud mm	Capacidad en mm	€/ u.
1481270	87 21 250	2	250	46	33,35
1481271	87 21 300	2 3/4	300	60	45,29



8701 - Tenaza para tuberías "COBRA"



Ajuste automático mediante pulsación de botón directamente en la pieza de trabajo. Ajuste preciso para adaptarse óptimamente a diversos tamaños de piezas y para una posición ergonómica del mango. Auto-retención en tuberías y tuercas, agarre perfecto a la pieza con el mínimo esfuerzo. Mordazas con dientes adicionalmente templados, dureza aprox. de los dientes 61 HRC: poco desgaste y gran seguridad en el agarre. Articulación machihembrada: gran estabilidad por la doble guía. Recepción segura del perno de articulación: imposible desajustar involuntariamente. Un retén protector evita lesiones por pellizcos. - Posiciones de ajuste: 13 - Capacidad de trabajo para tuercas (caras planas): Ø 1 in - Capacidad de trabajo para tuercas (caras planas): 27mm - Capacidad de trabajo para tubos (diámetro): Ø 29mm



Ref.	Código	Capacidad "	Longitud mm	Capacidad en mm	€ / u.
1239406	87 01 125	1	125	27	27,49
1239400	87 01 150	1 1/4	150	30	28,20
1239401	87 01 180	1 1/2	180	36	29,58
1239402	87 01 250	2	250	46	31,42
1239403	87 01 300	2 3/4	300	60	43,76
1239404	87 01 400	3 1/2	400	95	76,50
1239405	87 01 560	4 1/2	560	120	127,96

8603 - Tenaza llave



Sustituye a un juego completo de llaves de tuercas, tanto en métrica como en pulgadas. Mordazas planas para el cuidadoso montaje de grifos con tratamiento superficial - ¡para trabajar directamente sobre cromo!. Muy adecuada también para agarrar, sujetar, prensar y doblar piezas a mecanizar. Ajuste perfecto a las caras de las tuercas evitando que estas se redondeen. Ajuste automático mediante pulsación de botón directamente en la pieza de trabajo. Articulación antideslizante con mordazas de agarre de ajuste perfecto. Agarre perfecto gracias a las mordazas paralelas; su diseño permite adaptarla a todos los anchos de boca hasta el máximo especificado. El accionamiento entre las mordazas posibilita el ajuste y la liberación rápida de uniones roscadas gracias al efecto carraca. La fuerza ejercida en los mangos se multiplica por 10 en las mordazas, gran capacidad de sujeción. Llave universal idónea en formato de bolsillo. Imprescindible para juegos de herramientas para acciones rápidas. - Grosor de boca (articulación) [B2]: 7,0mm - Joint Thickness [B3]: 10,5mm - Tip Thickness [B1]: 4,7mm - Posiciones de ajuste: 14 - Capacidad de trabajo para tuercas (caras planas): Ø 1 - Capacidad de trabajo para tuercas (caras planas): 27mm



Ref.	Código	Entrecaras "	Entrecaras mm	Longitud mm	€ / u.
1483150	86 03 150	1	27	150	58,55
1483180	86 03 180	1 3/8	35	180	58,96
1483250	86 03 250	1 3/4	46	250	67,52
1483300	86 03 300	2 3/8	60	300	83,95

Tenaza para bombas de agua



Ref.	Código	L mm	Capacidad en mm	€ / u.
8004762	87250	250	6,0-38,0	25,50



SS410 Tenacilla para bomba de agua, inoxidable



Alicates articulados de acero inoxidable y con mangos recubiertos de PVC

Ref.	Código	Longitud mm	€ / u.
2400384	SS410-250	250	99,65
2400385	SS410-300	300	155,30



8601 - Tenaza llave



Tenaza llave Sustituye a un juego completo de llaves de tuercas, tanto en métrica como en pulgadas. Mordazas planas para el cuidadoso montaje de grifos con tratamiento superficial - ¡para trabajar directamente sobre cromo!. Muy adecuada también para agarrar, sujetar, prensar y doblar piezas a mecanizar. Ajuste perfecto a las caras de las tuercas evitando que estas se redondeen. Ajuste rápido mediante botón directamente en la pieza de trabajo. Articulación antideslizante con mordazas de agarre de ajuste perfecto. Agarre perfecto gracias a las mordazas paralelas; su diseño permite adaptarla a todos los anchos de boca hasta el máximo especificado. El accionamiento entre las mordazas posibilita el ajuste y la liberación rápida de uniones rosca-das gracias al efecto carraca. Mayor capacidad de agarre por dos posiciones adicionales de ajuste: Agarre continuo de todos los anchos de boca hasta 40 mm. Un 10 % menos de peso con la misma estabilidad. Escala práctica de ajuste: Una escala realizada con láser permite el preajuste del ancho de boca antes de agarrar. Con mordazas de agarre esbeltas - para situaciones de atornillado que requieren una herramienta esbelta. - Grosor de boca (articulación) [B2]: 8,0mm - Joint Thickness [B3]: 12,0mm - Tip Thickness [B1]: 5,0mm - Posiciones de ajuste: 15 - Capacidad de trabajo para tuercas (caras planas): Ø 112 - Capacidad de trabajo para tuercas (caras planas): 40mm



Ref.	Código	Longitud mm	€/ u.
2400054	86 01 180	180	53,81
2400055	86 01 250	250	57,38
2400056	86 01 300	300	77,21

8604 - Tenaza llave



Óptima accesibilidad incluso en espacios de difícil acceso: diseño especialmente compacto, cabeza estilizada. Ajuste preciso con una sola mano para una adaptación sencilla a todos los tamaños de piezas de trabajo. Enorme capacidad de agarre con una longitud de herramienta de solo 100 mm: Las bocas paralelas agarran de manera continua con un ancho de boca de hasta 21 mm. Mordazas lisas para el montaje delicado de racores y piezas sensibles con acabados de superficie que no se pueden marcar: se pueden usar directamente en el cromo gracias a su contacto suave en toda la superficie. Áreas de aplicación polivalentes: mecánica de precisión, fontanería, un componente esencial del juego de herramientas para cualquier bicicleta o motocicleta, una herramienta para llevar todos los días incluso para la maquetación. Un retén protector evita lesiones por pellizcos. Ajuste preciso con 10 posiciones de ajuste. - Posiciones de ajuste: 10 - Capacidad de trabajo para tuercas (caras planas): Ø 034 - Capacidad de trabajo para tuercas (caras planas): 21mm



Ref.	Código	Longitud mm	€/ u.
2400057	86 04 100 BK	100	54,77

8101 - Alicate para tuberías y racores



Ajuste preciso para una adaptación óptima a los diámetros más diversos. Para sifones, filtros de aceite, tubos de plástico y conectores de hasta 80 mm de Ø. Robusta y altamente resistente. Ideal para apretar y aflojar racores, conexiones de tubos de plástico y tuercas redondas. Para clavijas y acoplamientos con cierre roscado, p. ej. los racores redondos Cannon. Para soltar de forma cuidadosa mangueras de codos y cartuchos filtrantes. Adherencia óptima en superficies sin suciedad, aceite ni grasa. Articulación machihembrada ajustable en 25 posiciones. Geometría ergonómica de los mangos. Con mordazas de agarre estriada: hasta Ø 80 mm. - Capacidad de trabajo (diámetro): Ø 25 - 80mm - Posiciones de ajuste: 25



Ref.	Código	Capacidad mm	Para tuercas redondeadas mm	€/ u.
1481265	81 01 250	250	25-80	35,96
1481266	81 11 250	250	10-75	53,14

8711 - Tenaza "COBRA MATIC"



Todas las características de la KNIPEX Cobra® 87 01 250. Ajuste automático mediante pulsación de botón directamente en la pieza. Por el muelle situado de modo protegido, las tenazas se cierran automáticamente al accionar el pulsador (¡manejo con una sola mano!). - Posiciones de ajuste: 25 - Capacidad de trabajo para tubos (diámetro): Ø 2 - Capacidad de trabajo para tubos (diámetro): Ø 50mm - Capacidad de trabajo para tuercas (caras planas): 46mm



Ref.	Código	Capacidad "	Longitud mm	Para tuercas redondeadas mm	€ / u.
1451250	87 11 250	2	250	46	35,80

8741 - Tenaza múltiple ajustable



Para tuercas y tornillos métricos y en pulgadas con medidas de llave de 10 a 32 mm (3/8" a 1 1/4"); autoblocante en el rango a partir de 17 mm: sin deslizamiento sobre la pieza. Agarre sin holgura de tornillos de cabeza hexagonal métricos y en pulgadas, sin redondear la cabeza. Agarre seguro y firme incluso en tuercas y tornillos redondeados, oxidados o pintados. Ideal para trabajar en sistemas de frenos de vehículos. Apretar y aflojar rápidamente uniones ros-cadas conforme al principio de carraca. Ajuste mediante pulsación de botón directamente en la pieza, también es posible hacerlo con una mano. Ajuste preciso para adaptarse óptimamente a diversos tamaños de piezas y para una posición ergonómica del mango. Articulación machihembrada: gran estabilidad por la doble guía. Recepción segura del perno de articulación: imposible desajustar involuntariamente. Acción de palanca óptima: óptima transmisión de fuerza. Un retén protector evita lesiones por pellizcos. Sustituye a un juego de llaves de tuercas, ideal para fijar por contratuerca. - Posiciones de ajuste: 15 - Capacidad de trabajo para tuercas (caras planas): Ø 3/8 - 1 1/4in - Capacidad de trabajo para tuercas (caras planas): Ø 10 - 32mm



Ref.	Código	Capacidad "	Longitud mm	Para tuercas redondeadas mm	€ / u.
1461250	87 41 250	3/8 - 1 1/4	250	10 - 32	35,80

147 - Llave para tubo modelo sueco, 90°



Desatascador para tuberías de Ø 20-150 mm para instalaciones y labores de mantenimiento en hospitales e instalaciones municipales.

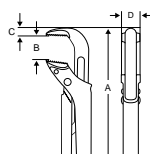

Ref.	Código	A mm	B mm	C mm	d mm	Peso grs.	€ / u.
1200348	147	1.060	160	38	35	7.210	434,96

8700 - Tenaza para tuberías "COBRA"



Óptima accesibilidad incluso en espacios de difícil acceso: diseño especialmente compacto, cabeza estilizada. Ajuste preciso con una sola mano para una adaptación sencilla a todos los tamaños de piezas de trabajo. Agarre seguro y de larga duración, garantizado por una alta resistencia al desgaste. Capacidad de agarre de Ø 28 mm, anchura de la llave de hasta 24 mm - solo 100 mm de longitud. Articulación machihembrada: alta calidad y durabilidad proporcionada por la guía doble. Superficies de agarre con dientes especialmente endurecidos, dureza aprox. 60 HRC. Auto-retención en tuberías y tuercas, agarre perfecto a la pieza con el mínimo esfuerzo. Un retén protector evita lesiones por pellizcos. Ajuste preciso con 11 posiciones de ajuste. - Posiciones de ajuste: 11 - Capacidad de trabajo para tuercas (caras planas): Ø 1 in - Capacidad de trabajo para tuercas (caras planas): 24mm - Capacidad de trabajo para tubos (diámetro): Ø 28mm



Ref.	Código	Capacidad "	Longitud mm	Capacidad en mm	€ / u.
21062001	87 00 100	1	100	24	28,61

8700 - Tenaza pico loro "COBRA"



Óptima accesibilidad incluso en espacios de difícil acceso: diseño especialmente compacto, cabeza estilizada. Ajuste preciso con una sola mano para una adaptación sencilla a todos los tamaños de piezas de trabajo. Agarre seguro y de larga duración, garantizado por una alta resistencia al desgaste. Capacidad de agarre de Ø 28 mm, anchura de la llave de hasta 24 mm - solo 100 mm de longitud. Articulación machihembrada: alta calidad y durabilidad proporcionada por la guía doble. Superficies de agarre con dientes especialmente endurecidos, dureza aprox. 60 HRC. Auto-retención en tuberías y tuercas, agarre perfecto a la pieza con el mínimo esfuerzo. Un retén protector evita lesiones por pellizcos. Ajuste preciso con 11 posiciones de ajuste. cartulina autoservicio/blíster. - Posiciones de ajuste: 11 - Capacidad de trabajo para tuercas (caras planas): Ø 1 in - Capacidad de trabajo para tuercas (caras planas): 24mm - Capacidad de trabajo para tubos (diámetro): Ø 28mm



Ref.	Código	€ / u.
2400058	87 00 100 BK	30,55

8726 - Tenaza "COBRA" aislada



Ajuste deslizando la boca directamente hacia la pieza de trabajo: manejo rápido, seguro y confortable. Ajuste preciso: permite la adaptación óptima a distintos tamaños de piezas y una posición ergonómica del mango. Fácil acceso a la pieza gracias al diseño esbelto en la zona de la cabeza y la articulación. Auto-retención en tuberías y tuercas, agarre perfecto a la pieza con el mínimo esfuerzo. Mordazas con dientes adicionalmente templados, dureza aprox. de los dientes 61 HRC: poco desgaste y gran seguridad en el agarre. Articulación machihembrada: gran estabilidad por la doble guía. Un retén protector evita lesiones por pellizcos. - Posiciones de ajuste: 24 - Capacidad de trabajo para tubos (diámetro): Ø 2in - Capacidad de trabajo para tuercas (caras planas): 46mm - Capacidad para tubos de pulgada (diámetro): Ø 50mm - comprobado por VDE: sí



Ref.	Código	Capacidad "	Capacidad mm	Capacidad mm	€ / u.
1456250	87 26 250	2	250	46	53,45

8223IP - Tenacilla articulada ajustable



ergo®

ISO 8976.

Ref.	Código	A mm	B mm	C mm	d mm	E mm	€/ u.
1276600	8223 IP	210	35	46	7,0	5	46,33
1276601	8224 IP	250	40	51	8,0	6	54,67
1276602	8225 IP	315	52	63	9,5	7	74,98

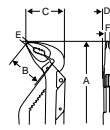

8231IP - Tenacilla articulada ajustable, gran capacidad



ergo®

ISO 8976.

Ref.	Código	A mm	B mm	C mm	d mm	E mm	€/ u.
1276650	8231 IP	225	52	63	9,5	7	48,97

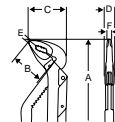

7224 - Tenacilla articulada con botón mango bimaterial



ISO 8976.

Ref.	Código	A mm	B mm	C mm	d mm	E mm	€/ u.
1276700	7224	250	43	49	16	4	34,43

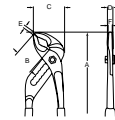

221D - Tenacilla de ojal



ISO 8976.

Ref.	Código	A mm	B mm	C mm	d mm	E mm	€/ u.
1276750	221 D	117	16	18.0	5.0	3.0	14,72
1276751	222 D	150	22	23.5	6.5	4.0	15,22
1276752	223 D	192	25	28.0	7.5	4.5	16,22
1276753	224 D	240	30	35.0	9.5	5.5	18,29
1276754	225 D	305	38	42.0	11.5	4.5	27,98

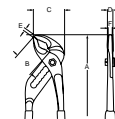

8551 A - Alicata para abrazaderas



Alicata para abrazaderas estándar, compactas y de alambre, así como aros elásticos de hasta 70 mm. Puntas universales giratorias para el agarre seguro en cualquier posición. Mangos de PVC.

Ref.	Código	Capacidad mm	Longitud mm	€/ u.
1481275	85 51 250 A	Máx 70	250	66,05



8551 AF - Alicata para abrazaderas con fijador



Alicata para abrazaderas estándar, compactas y de alambre, así como aros elásticos de hasta 70 mm. Puntas universales giratorias para el agarre seguro en cualquier posición. Con fijador para dejar la abrazadera presionada y poder trabajar con una sola mano. Mangos de PVC.

Ref.	Código	Capacidad mm	Longitud mm	€/ u.
1481280	85 51 250 AF	Máx 70	250	85,43



8551 C - Alicate para abrazaderas tipo "Click"



Alicate para abrazaderas tipo "Click" y "Norma". Para abrir y cerrar las abrazaderas fácilmente y sin esfuerzos, simplemente girando las bocas. Mangos de PVC.

Ref.	Código	Longitud mm	€/u.
1481285	85 51 250 C	250	65,59



1048INOX Alicate multiposición regulable, de acero inoxidable



• Modelo de 7 posiciones • Alta resistencia a la corrosión • Evita la oxidación incorrecta • Características mecánicas sobresalientes • Acero inoxidable AISI 420

Ref.	Código	L mm	A mm	L1 mm	S mm	€/u.
8005202	10480325	250	33	33	13	170,00



Tenaza curvatubos



Tenaza curvatubos para tubos de cobre blando, aluminio y acero de precisión

Ref.	Código	Descripción	€/u.
1268100	25131	Tenaza curvatubos 8 mm-5/6"	92,45
1268101	25132	Tenaza curvatubos 10 mm	94,95
1268102	25133	Tenaza curvatubos 12 mm	101,95
1268103	25135	Tenaza curvatubos 15 mm	126,95
1268104	25137	Tenaza curvatubos 18 mm	155,95



Llave STILLSON



Llave Stillson de doble resorte que garantiza una autosujeción rápida y firme

Ref.	Código	Descripción	€/u.
1268200	70350	Llave Stillson 8"	34,45
1268201	70351	Llave Stillson 10"	44,45
1268202	70352	Llave Stillson 12"	51,95
1268203	70353	Llave Stillson 14"	54,45
1268204	70354	Llave Stillson 18"	73,95
1268205	70355	Llave Stillson 24"	128,45
1268206	70356	Llave Stillson 36"	264,95



TAH380- Llave STILLSON para trabajos en altura



Llave de aluminio para tubos con acoplamiento rápido

Ref.	Código	Descripción	€/u.
2400386	TAH380-10	Llave Stillson Alum Altura 10	71,14
2400387	TAH380-14	Llave Stillson Alum Altura 14	94,57
2400388	TAH380-18	Llave Stillson Alum Altura 18	135,06
2400389	TAH380-24	Llave Stillson Alum Altura 24	200,36

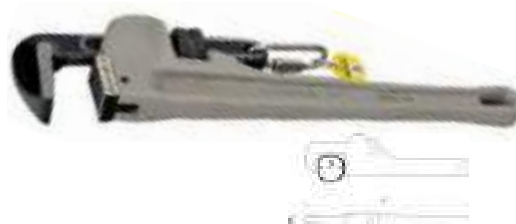

Llave STILLSON



Llave heavy duty de rápido ajuste de Ø gracias a escala en lengua

Ref.	Código	Descripción	€/u.
1268300	70150	Llave Heavy Duty 8"	36,95
1268301	70151	Llave Heavy Duty 10"	49,45
1268302	70152	Llave Heavy Duty 12"	54,95
1268303	70153	Llave Heavy Duty 14"	65,95
1268304	70154	Llave Heavy Duty 18"	88,45
1268305	70155	Llave Heavy Duty 24"	138,95
1268306	70156	Llave Heavy Duty 36"	304,95
1268307	70157	Llave Heavy Duty 48"	521,45



Llave STILLSON



Llave tipo Stillson en acero, rápido ajuste, mango monoblock, lengua y postizo forjados

Ref.	Código	Longitud "	Longitud mm	€/u.
8005557	122008	8	200	20,81
8005558	122010	10	250	33,74
8005559	122012	12	300	40,36
8005560	122014	14	350	56,19
8005561	122018	18	450	78,04
8005562	122024	24	600	115,60
8005563	122036	36	900	243,70



Llave STILLSON de aluminio



Llave tipo Stillson en aleación de aluminio, un 40% más ligera

Ref.	Código	Longitud "	Longitud mm	€/u.
8005564	104008	8	200	27,59
8005565	104010	10	250	40,08
8005566	104012	12	300	51,56
8005567	104014	14	350	58,31
8005568	104018	18	450	92,84
8005569	104024	24	600	156,09
8005570	104036	36	900	273,90



Llave STILLSON de aluminio



Llave de aluminio con aleación de aluminio de gran resistencia

Ref.	Código	Descripción	€/u.
1268400	70159	Llave de aluminio 10"	56,95
1268401	70160	Llave de aluminio 14"	61,45
1268402	70161	Llave de aluminio 18"	84,45
1268403	70162	Llave de aluminio 24"	148,95
1268404	70163	Llave de aluminio 36"	291,95
1268405	70168	Llave de aluminio 48"	592,95



Cortatubos FE



Ref.	Código	Descripción	€ / u.
1267600	70040		126,95
1267601	070046D	3 cuchillas hierro 1.1/4"	26,95
1267602	70045	SUPER 2" 10-60 mm	150,95
1267603	070051D	3 cuchillas hierro 2"	31,45



Cortatubos 3-30 mm



Ref.	Código	Descripción	€ / u.
1267800	71019	Cortatubos 3-30 mm	20,45
1267802	70056D	5 cuchillas INOX	43,95



71019

Cortatubos automático



Ref.	Código	Descripción	€ / u.
1268000	70030	Cortatubos automático 6-67 mm	129,95
1268001	70017D	5 cuchillas Cu	22,95



9031 - Cortatubos



Autoajuste del disco de corte a distintos diámetros de tubo. 4 rodillos guía con rodamientos incluidos. Válido para tubos de cobre, aluminio y acero inoxidable. Capacidad desde 6 a 35 mm.

Ref.	Código	Descripción	€ / u.
21062003	90 31 02 SB	Cortatubos automático 6-67 mm	75,02



9031 - Cortatubos TUBIX®



Cortatubos Fijación rápida con una mano QuickLock: deslizar, cortar y listo. Permite el uso rápido y preciso de la rueda de corte en tuberías de diferentes diámetros. Cómodo: corte sencillo con rodamientos en el disco de corte y los rodillos guía. Corta tubos de Ø 6 a 35 mm [1/4 "-1 3/8"] con espesor de hasta 2 mm. Disco de corte de acero para rodamientos de alta calidad. Práctico sistema de sustitución rápida para el disco de corte, con disco de repuesto almacenado bajo la tapa del mango. Con herramienta de desbarbado de precisión, fácil de extraer. Para el sector eléctrico: también apto para cortar conductos rígidos de acero. cartulina autoservicio/blíster. - Capacidades de corte (diámetro): Ø 6 - 35mm - Capacidades de corte (diámetro): Ø 1/4 - 1 3/8in

Ref.	Código	€ / u.
2400059	90 31 02 BK	75,02



9031 - Cortatubos TUBIX® XL



El corte perfecto para tuberías grandes con mecanismo QuickLock. Corte de grandes diámetros con rapidez y precisión, para tubos metálicos de entre Ø 6 y 76 mm (1/4" - 3")

Ref.	Código	€ / u.
2400060	90 31 03 BK	106,79



9022 - Cortatubos BIX



Cortatubos inteligente: corta tubos sin rebabas y se sujeta cómodamente. Puede cortar tubos de desagüe de plástico de alta temperatura y conductos eléctricos en muy poco tiempo. Puede utilizarse para cortar manguitos de sellado durante el montaje final: cerca de la pared, compatible con las normativas. Corta tubos de plástico sin reforzar de 20 a 50 mm de diámetro con un espesor de hasta 2,4 mm. Corta tubos rápida y limpiamente sin rebabas. Corta manguitos de sellado a 2 o 3 mm de la pared. Con cuchilla giratoria para cortar tubos de plástico (cuchilla en el centro) o manguitos de sellado (cuchilla en el exterior). Con mecanismo de bloqueo para un transporte seguro. La herramienta contiene dos cuchillas de recambio. - : Ø 20 - 50mm - : Ø 20 - 50mm

Ref.	Código	€ / u.
2400061	90 22 10 BK	28,71



Desatascador



Desatascador profesional manual y eléctrico con espiral de Ø 8 mm x 7,5 m. Resistente a los impactos y protegido del polvo.

Ref.	Código	Descripción	€ / u.
1462095	72095	Desatascador con espiral profesional manual y eléctrico, 7,5 m.	164,95



Bomba de comprobación



Bomba de comprobación para realizar comprobaciones de precisión de tuberías de agua y contenedores de hasta 50 bar. Sistema de sobre válvula y tanque con capacidad de 12 litros.

Ref.	Código	Descripción	€ / u.
1460200	60200	Bomba de comprobación 50-S. Hasta 50 bares, capacidad del tanque 12 ltrs.	299,95



Cabeza de terraja BSPT



Cabeza 600 BSPT-D 1/4" con fácil salida de las virutas para un roscado más rápido

Ref.	Código	Descripción	€ / u.
1268900	070821X	Cabeza de terraja BSPT 1/4"	97,95
1268901	070822X	Cabeza de terraja BSPT 3/8"	97,95
1268902	070823X	Cabeza de terraja BSPT 1/2"	109,45
1268903	070824X	Cabeza de terraja BSPT 3/4"	109,45
1268904	070825X	Cabeza de terraja BSPT 1"	117,45
1268905	070826X	Cabeza de terraja BSPT 1.1/4"	117,45
1268906	070842X	Cabeza de terraja BSPT 1.1/2"	117,45
1268907	070843X	Cabeza de terraja BSPT 2"	188,95



2951 - Mordaza grip bocas curvas con cortante



Niquelada. Con cortante. Polivalente, para taller, garaje, etc. Con tuerca de retención de la apertura deseada.

Ref.	Código	A mm	B mm	C mm	d mm	E mm	G mm	€ / u.
1238500	2951-140	140	22	47	6,5	4	4	18,13
1238501	2951-180	180	30	43	10,0	5	7	24,78
1238502	2951-250	250	35	54	11,0	6	11	28,54
1238503	2951-300	300	46	67	13,5	7	14	48,04

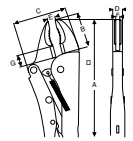

2953 - Mordaza grip boca curva sin cortante



Niquelada. Polivalente, para taller, garaje, etc. Con tuerca de retención de la apertura deseada.

Ref.	Código	A mm	B mm	C mm	d mm	E mm	€ / u.
1238600	2953-140	140	22	47	6,5	4	16,93
1238601	2953-200	190	30	43	10,0	5	22,51
1238602	2953-250	235	35	54	11,0	6	25,69
1238603	2953-300	300	46	67	13,5	7	44,40



2965 - Mordaza grip soldador



Horquillas de acero en cataphoresis. Cuerpo niquelado con tuerca de retención de la apertura deseada. Gran visibilidad para soldaduras.

Ref.	Código	A mm	B mm	C mm	d mm	E mm	€ / u.
1239000	2965-200	228	67	70	78	70	32,62
1239001	2965-280	290	87	70	88	70	43,20

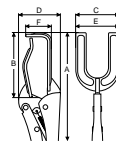

2966 - Mordaza grip soldador tubos



Horquillas de acero en cataphoresis. Cuerpo niquelado con tuerca de retención de la apertura deseada. Gran visibilidad para soldaduras.

Ref.	Código	A mm	B mm	C mm	d mm	E mm	€ / u.
1239100	2966-280	280	97	67	50	64	44,24

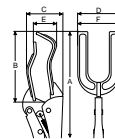

2963 - Mordaza grip "C"



Brazos de acero en cataphoresis. Cuerpo niquelado. Amarre rápido. Para construcción metálica. Con tuerca de retención de la apertura deseada.

Ref.	Código	A mm	B mm	C mm	d mm	E mm	€/ u.
1239201	2963-280	280	100	148	12	890	37,91
1239202	2963-450	460	265	160	12	165	62,22
1239203	2963-630	580	470	245	13	55	74,83

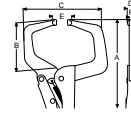

2997 - Grip gran capacidad



Acabado cromado. Herramienta universal para redondos, hexágonos, angulaciones, etc. 4 Posiciones de apertura amplían la capacidad de la grip bocas y cuerpo templados.

Ref.	Código	A mm	B mm	C mm	d mm	E mm	€/ u.
1238700	2997-250	235	38	58	17	14	67,97
1238701	2997-300	255	68	64	17	15	74,89

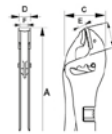

2958 - Mordaza grip boca recta



Polivalente reforzada, niquelada. Con tuerca de retención de la apertura deseada.

Ref.	Código	A mm	B mm	C mm	d mm	E mm	€/ u.
1238800	2958-140	235	38	58	17	14	17,97
1238801	2958-200	255	68	64	17	15	24,78
1238802	2958-250	250	45	73	16	14	28,54

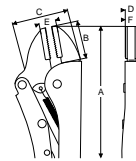

2964 - Mordaza grip "C" basculante



Brazos de acero en cataphoresis cuerpo niquelado. Bocas de apriete basculante. Con tuerca de retención de la apertura deseada.

Ref.	Código	A mm	B mm	C mm	d mm	E mm	€/ u.
1239304	2964-160	160	57	85	18	4	31,26
1239301	2964-280	280	113	137	32	6	41,22
1239302	2964-450	436	249	156	32	6	69,61
1239303	2964-600	630	430	152	32	6	81,53

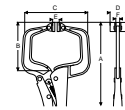

Remachadora manual para remaches NTS



Hasta Ø 5 mm. en aluminio y 4 mm en acero inox. Cuerpo de las tenazas: fundición a presión de aluminio de alta calidad. Brazo de las tenazas: acero forjado.

Ref.	Código	Carrera mm	Longitud mm	€/ u.
1239900	1434028	8	275	48,80



Remachadora manual para remaches BM-45



Remachadora manual tipo alicate modelo BM-45, capacidad de remachado de 2,4 a 4,0 mm. En cualquier material, ideal para bricolaje, muy económica, se suministra en caja de cartón.

Ref.	Código	Carrera mm	Longitud mm	€ / u.
1200225	02BM00450	5	250	14,00



Remachadora manual para remaches NTX



Hasta Ø 5 mm. en aluminio y 4 mm. en acero inox. Cuerpo de las tenazas: fundición a presión de aluminio de alta calidad. Brazo de las tenazas: acero cromo vanadio, forjado.

Ref.	Código	Carrera mm	Longitud mm	€ / u.
1240000	1434040	8	260	71,80



Remachadora manual para remaches BM-85



Remachadora manual tipo alicate modelo BM-85, capacidad de remachado de 2,4 a 4,0 mm. en cualquier material - 4,8-5,0 en aluminio. Palanca de acero, profesional. Garantía Europea, el ángulo del cabezal a 100° facilita el remachado, palanca intermedia multiplicador de esfuerzo, reduciendo a la mitad la fuerza a ejercer para remachar.

Ref.	Código	Carrera mm	Longitud mm	€ / u.
1200227	02BM00850	6	265	44,00



Remachadora manual para remaches FLIPPER



Reducción del esfuerzo en un 40%. Hasta Ø 5 mm. en aluminio y 4 mm. en acero inox. Diseño ergonómico con resorte de apertura para el óptimo accionamiento con una mano. Recipiente recogedor de vástagos de fácil vaciado.

Ref.	Código	Longitud mm	Tracción parcial mm	Tracción total mm	€ / u.
1240100	1433950	212	1,8	16,2	90,60



Remachadora manual para remaches HN 2



Cualquier clase de material desde Ø 3 mm a 6,4 mm. Cuerpo y de las tenazas: fundición a presión de aluminio de alta calidad. Sistema de tijera: acero altamente resistente y galvanizado; gracias a su diseño cerrado es muy sólido y está protegido contra la entrada de suciedad.

Ref.	Código	Carrera mm	Longitud mm	€ / u.
1240300	1434107	10	570	240,90



Remachadora manual para remaches BM-160



Remachadora manual dos brazos modelo BM-160, capacidad de remachado de 3,0 a 5,0 mm. en cualquier material - así como la gama de 4,8 estructural y 5,2 S-Trébol, profesional. Palanca intermedia multiplicador de esfuerzo, reduciendo a la mitad la fuerza a ejercer para remachar. Garantía Europea.

Ref.	Código	Carrera mm	Longitud mm	€ / u.
1200229	02BM01600	10	390	115,00



Remachadora manual para remaches BM-164



Remachadora manual dos brazos modelo BM-164, capacidad de remachado de 4,8-5,0 mm. Hasta 6,5 en cualquier material - así como la gama de 4,8-6,5 estructural y 5,2-6,4 y 7,8 S-Trébol, profesional. Palanca intermedia multiplicador de esfuerzo, reduciendo a la mitad la fuerza a ejercer para remachar. Garantía Europea.

Ref.	Código	Carrera mm	Longitud mm	€ / u.
1200230	02BM01640	10	405	150,00



Remachadora manual para remaches BM-68



La remachadora BM-68 es una herramienta de fuelle o extensión que coloca remaches de hasta 6,4 mm y gracias a su mango ergonómico optimiza la fuerza del operario. Está concebida para un uso profesional en trabajos de mantenimiento y reparación.

Ref.	Código	Carrera mm	Longitud mm	€ / u.
21023000	02BM00680	8	295	138,00



Remachadora manual para remaches BM-92



Remachadora manual dos brazos modelo BM-92 "acodada", capacidad de remachado de 3,0 a 5,0 mm en cualquier material, 6,0 mm en Aluminio - profesional. Garantía Europea.

Ref.	Código	Carrera mm	Longitud mm	€ / u.
1200231	02BM00920	10	440	162,00



Remachadora para tuercas remachables GBM - M5



Hasta M6 de aluminio y hasta M5 acero, latón y acero inox. Fácil ajuste de la carrera mediante tuerca moleteada con escala de carrera. Asentamiento seguro y completo de las tuercas remachables. Cuerpo de las tenazas: fundición de aluminio a presión, de alta calidad. Brazo de las tenazas: cromo, vanadio, acero, forjados.

Ref.	Código	Longitud mm	€ / u.
1240400	1434761	260	106,20



Remachadora manual para tuercas remachables T-105



Remachadora manual tipo alicate para tuercas remachables T-105, capacidad de remachado de M-3 a M-5 en cualquier material y M-6 en aluminio y acero. Máxima calidad, garantía europea

Ref.	Código	Carrera mm	Longitud mm	€ / u.
1200235	02TR01050	7,5	265	56,00



Remachadora manual para tuercas remachables TR-308



Remachadora dos brazos para tuercas remachables modelo TR-308, capacidad de remachado de M-3 a M-8, garantía europea, profesional, sistema sencillo de roscado y desenroscado de la tuerca. Palanca intermedia multiplicador de esfuerzo, reduciendo a la mitad la fuerza a ejercer para remachar

Ref.	Código	Carrera mm	Longitud mm	€ / u.
1200236	02TR03080	60	390	210,00



Remachadora manual para tuercas remachables TR-412



Remachadora dos brazos para tuercas remachables modelo TR-412, capacidad de remachado de M-4 a M-12, muy práctica para fijar elementos en espacios reducidos. Trabajo con muy poca fuerza gracias al diseño especial en la palanca. Fácil ajuste y rápido cambio de machos. Palanca fabricada en fleje de acero plegado, que la hace ligera y cómoda.

Ref.	Código	Carrera mm	Longitud mm	€ / u.
21023001	02TR04120	70	390	195,00



Remachadora para tuercas remachables GBM 50



Tuercas remachables desde M3 hasta M12. Suministro en maletín plástico con accesorios para M5, M6, M8 y M10. Equipada con mecanismo de bola, para un enroscado rápido y sencillo de la tuerca en la herramienta y su posterior desenroscado. Disponibilidad de accesorios para tuerca macho desde M4 hasta M8.

Ref.	Código	Longitud mm	€ / u.
21045000	1619730	485	433,00



Remachadora para tuercas remachables GBM 40-R



Tuercas remachables desde M3 hasta M12. Suministro en maletín plástico con accesorios para M5, M6, M8 y M10. Sistema de carraca que posibilita el remachado de tuercas de grandes dimensiones en circunstancias de reducida accesibilidad y espacios de amplitud limitada para el accionamiento. Disponibilidad de accesorios para tuerca macho desde M4 hasta M8.

Ref.	Código	Longitud mm	€ / u.
21045001	1619731	155	394,65



4559 - Cortavarillas



Ref.	Código	HRC 40	HRC 48	Ø cuerda de piano mm	Longitud mm	€/ u.
1240600	4559-12	6	5	4	320	87,34
1240601	4559-18	8	7	6	430	108,60
1240602	4559-24	10	9	8	600	129,39
1240603	4559-30	13	10	9	750	155,58
1240604	4559-36	15	12	11	900	204,21
1240605	4559-42	15	12	11	1.060	286,15



7172 - Cortavarillas



Filos con dureza de 62 HRC. Gran capacidad de corte. Corta material con dureza de hasta 48 HRC. Confortable gracias a sus 12 posiciones de ajuste. Mangos con fundas bicomponente.

Ref.	Código	HRC 40 - Ø mm	HRC 48 - Ø mm	Longitud mm	€/ u.
1462460	71 72 460	6	5	460	112,56
1462610	71 72 610	8	7	610	130,25
1462760	71 72 760	9	8	760	170,54
1462910	71 72 910	10	9	910	230,11



6009 - Cortavarillas



• Cabezas forjadas en una sola pieza, irrompibles. • Tratamiento térmico 3+ para alargar la vida útil de la herramienta: no se rompe, no se deforma, no se desgasta. Filos templados por inducción a gran profundidad. • Sistema de ajuste de cuchillas mediante tornillo de eje descentrado para asegurar una perfecta alineación de los filos. • Empuñaduras en elastómero para evitar el deslizamiento de la mano durante el corte. • Pintura epoxi para evitar la oxidación de la herramienta.

Ref.	Código	A mm	B mm	€/ u.
1240850	6009-450	472	70	97,33
1240851	6009-600	627	85	110,69
1240852	6009-750	779	97	144,12
1240853	6009-900	929	110	183,29
1240854	6009-1050	1.070	125	238,38



26009 - Cortavarillas



Cortavarillas con cuchillas forjadas en una sola pieza y filos templados por inducción para una mayor resistencia al desgaste. Mango cerrado para facilitar el corte. Para trabajos de cortar ferralla.

Ref.	Código	A mm	Capacidad de corte en varilla blanda (en mm)	Capacidad de corte en varilla dura (en mm)	€/ u.
2400076	26009-300	300	5	4	20,31
2400077	26009-350	500	7	5	25,40



Cortavarillas



Mangos ergonómicos con protección antideslizante. Acero especial al cromo-vanadio. Tornillos excéntricos dobles para el reajuste de las cuchillas. Cabeza de cuchillas intercambiable.

Ref.	Código	L mm	€ / u.
8004763	71460	460	67,24
8004764	71610	610	86,32
8004765	71760	760	114,04



2820VBC - Cortavarillas, aislado



IEC 60900.

Ref.	Código	120 kg/mm2 Ø mm2	160 kg/mm2 Ø mm2	80 kg/mm2 Ø mm2	Longitud mm	€ / u.
1245101	2820VBC	8	7	9	630	227,32



Recambio cortavarillas



Mangos ergonómicos con protección antideslizante. Acero especial al cromo-vanadio. Tornillos excéntricos dobles para el reajuste de las cuchillas. Cabeza de cuchillas intercambiable.

Ref.	Código	L mm	€ / u.
8004766	79460	460	38,40
8004767	79610	610	49,20
8004768	79760	760	73,24



Serie 1300TH - Extractor hidráulico 3 patas oscilantes



Ref.	Código	Ø mm2	B mm	Potencia Tn	€ / u.
1245200	3310TH	315	350	10	1.910,06
1245201	3318TH	320	480	20	2.668,54
1245202	3330TH	410	650	30	3.176,99
1245203	3352TH	710	980	50	5.931,64



Serie 130THA - Extractor hidráulico 3 patas autocentrantes



Ref.	Código	A mm	B mm	Potencia Tn	€ / u.
1245300	3310THA	315	350	10	595,82
1245301	3318THA	320	480	20	2.917,30
1245302	3330THA	410	650	30	1.430,73
1245303	3352THA	710	980	50	2.687,78
1245304	3395THA	1.000	1.600	100	13.614,64



Serie 1000 - Extractor 2 patas rígidas



Ref.	Código	A mm	B máx. mm	B mín. mm	€/ u.
1245410	1001	50	60	12	67,50
1245400	1002	80	80	25	87,46
1245401	1002L	135	80	20	96,20
1245402	1003	80	115	25	96,62
1245403	1003L	135	115	25	105,35
1245404	1010	160	155	25	179,30
1245405	1010L	220	145	25	192,19
1245406	1010A	160	195	30	201,14
1245407	1015	220	195	60	224,12
1245408	1020	260	250	80	388,34
1245409	1020A	260	390	125	516,36
1245411	1020L	390	245	80	527,90
1245412	1020LA	390	375	125	655,93
1245413	1020X	260	600	215	794,66
1245414	1020LX	390	600	215	934,23



Serie 1100 - Extractor de alargaderas



Ref.	Código	A mm	B máx. mm	B mín. mm	€/ u.
1245500	1102	120	110	46	82,26
1245501	1103	120	140	46	91,42
1245502	1110	190	195	62	189,80
1245503	1120	255	325	105	369,20
1245505	1128	255	445	173	490,46
1245506	1135	480	450	178	1.084,30
1245507	1150	680	580	219	1.882,40



Serie 1200 - Guillotina



Ref.	Código	A máx. mm	A mín. mm	B mm	€/ u.
1245600	1202A	60	4	60	72,80
1245601	1203A	80	6	80	95,47
1245602	1204B	110	10	110	132,81
1245603	1206B	134	12	155	270,40
1245604	1208B	210	14	180	426,40
1245605	1208C	210	14	180	426,40
1245606	1210C	250	17	260	898,98
1245607	1210D	250	17	260	898,98
1245608	1212D	300	35	300	1.363,44
1245609	1213D	300	35	335	2.434,64



Conjunto 1100/1200



Ref.	Código	A mm	B mín. mm	C mm	€/ u.
1245700	1102-1202 A	100	55	90	155,06
1245701	1103-1203 A	100	80	130	186,89
1245702	1110-1204 B	152	108	175	322,61
1245704	1120-1206 B	220	134	230	639,60
1245711	1128-1208 B	220	180	302	916,86
1245706	1135-1208 C	418	180	285	1.510,70
1245707	1135-1210 C	418	250	372	1.983,28
1245708	1150-1210 D	617	250	362	2.781,38
1245709	1150-1212 D	617	300	435	3.245,84
1245710	1150-1213 D	617	300	450	4.317,04



Serie 1300 - Extractor mecánico 2 patas oscilantes



Ref.	Código	A mm	B mm	€/ u.
1245800	1300	55	70	36,92
1245801	1301	85	100	48,36
1245802	1304	135	150	72,18
1245803	1307	180	200	106,08
1245808	1308	180	250	116,06
1245804	1310	300	310	208,62
1245805	1317	370	425	385,53
1245806	1330	460	520	812,45
1245807	1350	750	800	1.303,95



Serie 1300L - Extractor mecánico 2 patas oscilantes largas



Ref.	Código	A mm	B mm	€/ u.
1245906	1300L	70	90	41,91
1245900	1301L	105	110	51,48
1245901	1304L	185	175	78,42
1245902	1307L	225	240	113,36
1245907	1308L	225	290	123,34
1245903	1310L	400	360	219,65
1245904	1317L	485	480	422,97
1245905	1330L	585	650	864,45
1245908	1350L	900	980	1.453,71



Serie 1300T - Extractor mecánico 2/3 patas oscilantes



Ref.	Código	A mm	B mm	Combina 2/3 patas	€/ u.
1246000	1300T	55	70	no	51,90
1246001	1301T	85	100	si	70,82
1246002	1304T	135	150	si	106,39
1246003	1307T	180	200	si	141,96
1246008	1308T	180	250	si	159,12
1246004	1310T	300	310	si	321,57
1246005	1317T	370	425	no	572,73
1246006	1330T	460	520	no	1.056,02
1246007	1350T	750	800	no	1.792,13



Serie 1300 LT - Extractor mecánico 2/3 patas oscilantes largas



Ref.	Código	A mm	B mm	Combina 2/3 patas	€/ u.
1246106	1300LT	70	90	no	59,38
1246100	1301LT	105	110	si	75,50
1246101	1304LT	185	175	si	115,75
1246102	1307LT	225	240	si	152,88
1246107	1308LT	225	290	si	170,04
1246103	1310LT	400	350	si	338,10
1246104	1317LT	480	480	no	628,89
1246105	1330LT	590	650	no	1.134,02
1246108	1350LT	900	980	no	2.016,77



Serie 1400L - Extractor mecánico 2 patas reversibles largas



Ref.	Código	A mm	B mm	€/ u.
1246200	1401L	85	120	48,57
1246201	1404L	135	170	73,22
1246202	1407L	180	235	109,72
1246204	1408L	180	280	126,26
1246203	1410	260	320	195,10



Serie 1400LT - Extractor mecánico 2/3 patas reversibles largas



Ref.	Código	A mm	B mm	Combina 2/3 patas	€/ u.
1246300	1401LT	85	130	si	71,14
1246301	1404LT	135	185	si	107,95
1246302	1407LT	180	240	si	157,25
1246304	1408LT	180	285	si	174,41
1246303	1410T	260	320	si	301,29



Serie 1500 - Extractor mecánico de interiores



Ref.	Código	A mm	B máx. mm	B mín. mm	Combina con	€/ u.
1246400	1506	115	145	40	1110-1120	227,66
1246401	1507	140	160	32	1110-1120	242,11
1246402	1509	150	240	60	1120-1135	413,82



Serie 1500A - Extractor mecánico de interiores



Ref.	Código	A mm	B máx. mm	B mín. mm	€ / u.
1246500	1506A	115	145	40	226,10
1246501	1507A	140	160	32	240,55
1246502	1509A	150	240	60	401,75



Serie 1600 - Extractor para rodamientos de bolas



Ref.	Código	Nº Pata - L Pata	Rodamientos que extraen	€ / u.
1246600	1600-1	11-160 12-160 13-180	6000, 6001, 6002, 6003, 6200, 16002, 16003, 16100, 16101 6004, 6005, 6006, 6201, 6202, 6203, 6300 6204, 6205, 6301, 6302, 6303, 62/22	319,49
1246601	1600-2	21-196 22-196	6007, 6008, 6009, 6010, 16011, 6011, 6012, 6206, 6207, 6304, 6305, 6306, 62/28	346,32
1246602	1600-3	31-237 32-239	6208, 6209, 6210, 6307, 6403, 63/28	482,04
1246603	1600-A	Todas	Conjunto con los 3 extractores	1.038,75



Serie 1750 - Extractor de patas finas



Ref.	Código	A mm	B mm	a mm	€ / u.
1246700	1750C	110	140	2	163,59
1246701	1750	145	140	2	166,50
1246702	1750L	195	140	2	171,91
1246703	1760	200	210	3,5	214,66
1246704	1760L	300	210	3,5	230,88

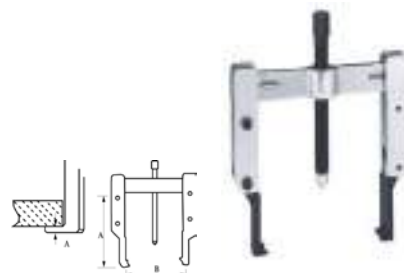

Serie 1800 - Extractor mecánico múltiple 2 patas



Ref.	Código	A mm	B mm	€ / u.
1246800	1805	140	173	165,88
1246803	1805-C	140	173	186,06
1246801	1810	182	250	236,29
1246802	1810-C	182	250	268,53



Serie 1800T - Extractor mecánico múltiple 3 patas



Ref.	Código	A mm	B mm	€/ u.
1246900	1805T	140	157	227,03
1246901	1810T	182	240	391,35



Serie 2400 - Extractor mecánico 2 patas



Ref.	Código	A mm	B mm	€/ u.
1247000	2410	100	95	84,76
1247001	2415	100	135	89,86
1247002	2420	150	165	140,92
1247003	2425	155	190	146,33
1247004	2430	205	240	227,86
1247005	2435	200	350	247,10
1247006	2440	200	510	482,56
1247007	2450	225	640	966,16



Serie 2400L - Extractor mecánico, 2 patas largas



Ref.	Código	A mm	B mm	€/ u.
1247100	2410L	200	95	96,41
1247101	2415L	200	135	101,50
1247102	2420L	305	165	149,86
1247103	2425L	305	190	155,27
1247104	2430L	380	250	261,56
1247105	2435L	380	350	280,80
1247106	2440L	380	510	516,26
1247107	2450L	350	640	1.131,52



Serie 2640 - Extractor para poleas



Ref.	Código	B mm	Posición 1	€/ u.
1247300	2641	55	90	81,33
1247301	2642	125	70	102,02
1247302	2643	125	80	122,20

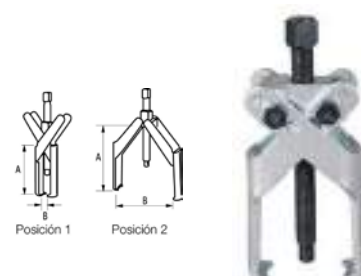

Juego de extractores de interiores



Ref.	Código	Barra	Puente	Pinza	€/ u.
1248000	43-10	+ 4390	-	4305 a 4330 Ø 5 a 37	454,27
1248001	43-22	+ 4390	+ 4392	4305 a 4338 Ø 5 a 46	650,10
1248002	43-30	+ 4390	-	4312 a 4338 Ø 12 a 46	427,02
1248003	43-42	+ 4390	+ 4392	4305 a 4365 Ø 5 a 76	1.042,50
1248004	43-11	-	+ 4392	4305 a 4330 Ø 5 a 37	498,16
1248005	43-31	-	+ 4392	4312 a 4338 Ø 12 a 46	469,87
1248006	43-52	+ 4390	+ 4392	4320 a 4365 Ø 20 a 76	847,08



Extractor de interior pinza



Ref.	Código	Ø Medida	Ref. componentes	€/ u.
1247400	4305	5 a 7	250005	45,34
1247401	4308	8 a 11		47,32
1247402	4312	12 a 14		63,23
1247403	4315	15 a 19		66,04
1247404	4320	20 a 24		73,42
1247405	4325	25 a 29		79,14
1247406	4330	30 a 37		83,10
1247407	4338	38 a 46		98,49
1247408	4347	47 a 54		136,03
1247409	4355	55 a 64		161,51
1247410	4365	65 a 76		193,23



Barra de impacto



Sirven para todas las pinzas. Sin ningún tipo de adaptador.

Ref.	Código	€/ u.
1247800	4390	86,63



Puente



Ref.	Código	€/ u.
1247900	4392	130,52



Husillo



Ref.	Código	Medidas	€/ u.
1247700	430507	4.305	13,83
1247701	430807	4.307	15,08
1247702	431207	4.312	14,14
1247705	431507	4.315	15,08
1247703	432030	4.320 a 4.338	20,49
1247704	434730	4.347 a 4.365	30,16



Casquillo



Ref.	Código	Medidas	€/ u.
1247500	250005	5 a 7	31,51
1247501	251005	8 a 11	32,14
1247502	431205	12 a 14	36,40
1247503	431505	15 a 19	38,27
1247504	432005	20 a 24	40,25
1247505	432505	25 a 29	45,97
1247506	433005	30 a 37	49,92
1247507	433805	38 a 46	65,31
1247508	434705	47 a 54	87,36
1247509	435505	55 a 64	112,84
1247510	436505	65 a 76	144,56



Cazoleta



Ref.	Código	Medidas	€/ u.
1247600	431201	4.312 a 4.338	12,69
1247601	434701	4.347 a 4.365	18,51



9300K - Estuche pequeño extractor mecánico



Ref.	Código	Se pueden componer	€/ u.
1248100	9300K	9300 - 9300 T - 9301 - 9301 T	172,12

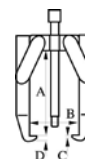

Juego 9084 / 4 TN Kit Combi



El aprovechamiento de las piezas comunes economiza el juego.

Ref.	Código	Se pueden componer	€/ u.
1248300	9084	1002L- 1002 - 1102 - 1202 A - 5010 1304 - 1304 T - 1404 - 1404 T	467,90



Juego 9087 / 7 TN Kit Combi

FORZA 

Ref.	Código	Se pueden componer	€/ u.
1248400	9087	1010 - 1110 - 1204 B - 1307 L 1307 LT - 1407 - 1407 T - 2301 - 2302	809,74



4100 - SET BALL. Para rodamientos de bolas

FORZA 

Realiza la extracción agarrando entre las pistas exterior e interior del rodamiento. Sus patas, en forma de bola, se introducen entre ambas pistas minimizando la resistencia y asegurando una rápida extracción.

Ref.	Código	Ø rodamiento	Rodamiento ISO	€/ u.
1248200	4100	de 20 a 95 mm	6004 a 6010 6200 a 6205 6300 a 6304 61812 a 61816	196,56
1248201	4105	de 35 a 117 mm	6008 a 6017 6205 a 6212 6304 a 6308 6404 a 6405	286,42
1248202	4125	de 62 a 195 mm	6018 a 6030 6212 a 6224 6309 a 6319 6407 a 6414	641,47



Serie 2000 - Extractor de espárragos

FORZA 

Ref.	Código	Ø máx.	Ø mín.	€/ u.
1248500	2001	16	10	63,86
1248501	2002	25	15	95,68



Serie 2100 - Extractor de espárragos



Ref.	Código	Ø máx.	Ø mín.	€/ u.
1248600	2101	19	6	53,25



Serie 2300 - Extractor de espárragos



Ref.	Código	Ø máx.	Ø mín.	€/ u.
1248700	2301	9,5	4,5	42,85
1248701	2302	19	8	67,91
1248702	2303	25	15	103,17



Juego de tornillos rotos de machos estriados



Ref.	Código	Contenido	€/ u.
1248800	5010	Juego en caja de plástico	50,54



Extractor de tornillos rosca izquierda



Ref.	Código	Contenido	€/ u.
1248502	5010R	Juego de tres piezas de 5 mm a 22 mm	27,56



Juego con brocas y guías



Ref.	Código	Contenido	€/ u.
1248900	5010C	Juego completo con 5 brocas y 10 guías exteriores	101,71
1248901	5010CD	Juego completo con 5 brocas y 10 guías exteriores e interiores	106,18
1248902	5010KI	Juego de 5 brocas izquierdas y 10 guías interiores y exteriores	131,35



Juego de machos en espiral



Ref.	Código	Medidas	Contenido	€/ u.
1249000	5010N	de M6 a M16	Juego de cuatro extractores en espiral	76,65



Juego con brocas y guías



Ref.	Código	Contenido	€/ u.
1249100	5010TR	Juego completo con 4 extractores, 4 brocas y 8 guías	108,68



Extractor de rótulas



Ref.	Código	Altura mm	Ø	€/ u.
1249200	5681	50	18 a 22	67,81
1249201	5683	95	28 a 32	144,56
1249202	5685	120	32 a 36	209,98



Extractor de rótulas



Ref.	Código	Altura mm	Ø	Posiciones	€/ u.
1249300	5691	56	20 a 24	2	105,25



Extractor de rótulas



Ref.	Código	Altura mm	Ø	Posiciones	€/ u.
1249400	5693	90	20 a 24	4	153,09



Extractor de filtro de aceite de garras de acero templado



Ref.	Código	Dimensiones Ø filtro mm	€/ u.
1249500	5000	de 55 a 72	80,18
1249501	5001	de 68 a 110	112,42
1249502	5001G	de 110 a 142	214,97
1249600	5000M	de 55 a 72	83,30
1249601	5001M	de 68 a 110	116,69
1249602	5001GM	de 110 a 142	228,80



Extractor de filtro de aceite de fleje



Ref.	Código	Dimensiones Ø filtro mm	€/ u.
1249700	5002	de 65 a 110	16,43
1249701	5003	de 110 a 155	18,62
1249702	500238	Fleje repuesto 5002	2,70
1249703	500338	Fleje repuesto 5003	3,95



Extractor autocentrante 2/3 patas



Ref.	Código	A mm	B mm	Potencia	€/ u.
1277000	1301ALT	105	110	1	141,86
1277001	1304ALT	185	175	4	183,04
1277002	1307ALT	225	240	7	263,54
1277003	1310ALT	410	350	10	528,74
1277004	1317ALT	500	480	17	906,26
1277005	1330ALT	600	680	30	1.444,25

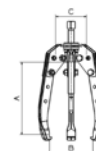

Extractor con barra de impacto interior y exterior



Ref.	Código	Exterior mm	Interior mm	€/ u.
1277050	4702C	0-75	25-100	236,70



Serie 4720 - Juego completo extractores interior y exterior



Interior: Ø 12 - Ø 100 mm. Exterior: Ø 0 - Ø 75 mm.

Ref.	Código	Pinza	Barra	Extractor	€/ u.
1277052	4720	4312 - 4315 - 4320	4390	4702	452,30



Prensa hidráulica



Ref.	Código	Carrera mm	d mm	E mm	F mm	G mm	ØA mm	ØA mm	Ton	€/ u.
1277100	2650	4	73	8	170	103	45	20	5	176,28
1277101	2655	2	82	12	170	103	70	28	11	261,98

5515L - Espejo con aumento con mango de plástico



Ref.	Código	Longitud mm	Ø mm	€/ u.
1277200	5515L	160	21	27,16



5515M - Espejo con mango metálico



Ref.	Código	Longitud mm	Ø mm	€/ u.
1277250	5515M	160	21	35,59



5515B - Espejo con mango de plástico



Ref.	Código	Longitud mm	Ø mm	€/ u.
1277300	5515B	220	28.5	25,74



5515GV - Espejo de aumento, articulado



Ref.	Código	Longitud mm	Ø mm	€/ u.
1277350	5515GV	215	30	35,72



5515T - Espejo de aumento, telescópico y articulado



Ref.	Código	Longitud mm	Ø mm	€/ u.
1277400	5515T-52	290-450	50	13,37



12921N - Espejo telescópico y articulado



Ref.	Código	Longitud mm	Ø mm	€/ u.
1249750	77401030	Alcance 265-705	30	50,30
1249751	77401040	Alcance 275-715	40	51,25
1249752	77401050	Alcance 285-725	50	56,25
1249754	77401060	Alcance 295-735	60	59,15



6010 - Tornillo de banco



Ref.	Código	B mm	C mm	d mm	Longitud mm	Longitud mm	€ / u.
1249800	601000800	125	66	122	325	80	239,10
1249801	601001000	150	80	152	402	100	318,78
1249802	601001250	200	98	182	492	125	439,07
1249803	601001500	235	118	211	551	150	624,07

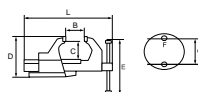

6010M - Pareja de mordazas y tornillos



Ref.	Código	Longitud mm	€ / u.
1249900	6010M0800	80	24,82
1249901	6010M1000	100	25,42
1249902	6010M1250	125	37,59
1249903	6010M1500	150	46,01

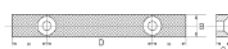

6072 - Tornillo de banco



Ref.	Código	B mm	C mm	d mm	Longitud mm	Longitud mm	€ / u.
1250100	607201000	125	66	122	325	100	248,11
1250101	607201250	150	80	152	402	125	347,35
1250102	607201500	200	98	182	492	150	446,59
1250103	607201750	235	118	211	551	175	595,46

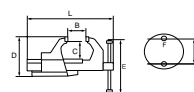

6072M - Pareja de mordazas y tornillos



Ref.	Código	Longitud mm	€ / u.
1250200	6072M1000	100	29,63
1250202	6072M1500	150	45,95
1250203	6072M1750	175	56,70

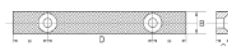

Tornillo de banco de acero fundido guía cuadrada



Ref.	Código	B mm	C mm	D mm	Longitud mm	€ / u.
2400032	TGC080	85	76	149	80	127,88
2400033	TGC100	105	91	180	100	170,63
2400034	TGC125	130	104	195	125	265,50
2400035	TGC150	155	108	216	150	382,00



Tornillo de banco de acero fundido guía redonda



Ref.	Código	B mm	C mm	D mm	Longitud mm	€ / u.
2400036	TGR080	85	69	144	80	123,00
2400037	TGR100	105	89	180	100	164,00
2400038	TGR125	130	102	210	125	253,50
2400039	TGR150	155	108	216	150	363,58



833 - Mordaza para tornillo de banco



Ref.	Código	Longitud mm	€ / u.
1250400	833AJ-4	100	36,92
1250401	833AJ-5	125	38,34
1250402	833AJ-6	150	39,91
1250406	833FJ-4	100	42,15
1250407	833FJ-5	125	43,41
1250408	833FJ-6	150	45,13



833AJ



833FJ

6700 - Tornillo de banco forjado



• Fabricados con Acero Especial Bellota. • Mordazas tratadas termicamente y moleteadas para garantizar un mejor agarre. • Amplio yunque que proporciona una mayor superficie de trabajo. • Apoyo sobre guía cuadrada, mayor estabilidad. • Muy robustos.

Ref.	Código	A mm	B mm	C mm	d mm	E mm	€ / u.
1277600	6700-100	100	125	125	60	52	237,03
1277601	6700-125	125	148	150	70	62	335,75
1277602	6700-150	150	178	200	90	75	433,18
1277603	6700-175	175	208	220	105	95	579,03



Tornillo de banco forjado



Fabricado en acero forjado. Guía cuadrada ajustable. Mordazas intercambiables de acero templado. Base de yunque. Incluye mordazas de aluminio imantadas.

Ref.	Código	Descripción	€ / u.
8001527	55100	Tornillo de banco guía cuadrada 10	156,56
8001528	55125	Tornillo de banco guía cuadrada 12,5	192,45
8001529	55150	Tornillo de banco guía cuadrada 15	359,33



834V 2 - Tornillo de sobremesa



Ref.	Código	B mm	C mm	d mm	H mm	Longitud mm	€ / u.
1250500	834V-2	63	75	47	225	210	126,25



Sargento de apriete modelo E



Cabezales de fundición nodular. Llanta de acero laminado de alta resistencia 90 kg/mm². Freno antideslizante en cabezal móvil. Sección de llanta 30 x 8.

Ref.	Código	Alcance cm	Apertura	€ / u.
1250701	3015	8,5	15	21,40
1250702	3020	8,5	20	23,03
1250703	3025	8,5	25	24,73
1250704	3030	8,5	30	26,22
1250705	3040	8,5	40	28,79



Sargento de apriete modelo F



Cabezales de fundición nodular. Llanta de acero laminado de alta resistencia 90 kg/mm². Freno antideslizante en cabezal móvil. Sección de llanta 35 x 8.

Ref.	Código	Alcance cm	Apertura	€ / u.
1250804	4040	12	40	32,08
1250806	4050	12	50	34,76
1250807	4060	12	60	37,28
1250809	4080	12	80	43,06
1250811	4100	12	100	48,67



4003-P - Tornillo de apriete super-extra. Trabajos ligeros



Ref.	Código	Alcance cm	Apertura cm	Sección de llanta	€ / u.
1278203	1529030	9	30	30x8	30,51
1278204	1529040	9	40	30x8	34,47
1278254	1525040	12	40	35x8	39,67
1278255	1525050	12	50	35x8	43,03
1278256	1525060	12	60	35x8	46,28
1278257	1525080	12	80	35x8	53,04
1278258	1525100	12	100	35x8	59,63
2400001	1528030	14	30	40x10	59,00
1278300	1528040	14	40	40x10	62,92
1278301	1528050	14	50	40x10	66,55
1278302	1528060	14	60	40x10	69,59



Sargento de Maxipress F



Cabezales curvos que permite librar bordes y resaltes. Cabezales de fundición. Llanta 35x8 revestidos con pintura Epoxy. Dispositivo posicionador y anticaída en brazo móvil. Llanta de acero de 35x8 laminado de alta resistencia [90kg.mm²] Mango ergonómico multiposición y recambiable. Hendiduras en el brazo fijo para el amarre de tubos, perfiles, etc. . Orificio para engrasar el mecanismo

Ref.	Código	Alcance cm	Apertura cm	€ / u.
21093000	60020	12	20	32,21
21093002	60030	12	30	35,59
21093003	60040	12	40	38,71
21093004	60050	12	50	41,94
21093005	60060	12	60	45,00
21093006	60080	12	80	51,98
21093007	60100	12	100	58,74
21093008	60120	12	120	65,45
21093009	60150	12	150	74,82



4003-PA - Tornillo de apriete super extra con mecanismo de alto rendimiento



Ref.	Código	Alcance cm	Apertura cm	Sección de llanta	€ / u.
2400002	1515030	13	30	35x8	42,27
2400003	1515040	13	40	35x8	45,91
2400004	1515050	13	50	35x8	49,25
2400005	1515060	13	60	35x8	52,48



Sargento de apriete modelo R



Cabezales de fundición nodular. Llanta de acero laminado de alta resistencia 90 kg/mm². Freno antideslizante en cabezal móvil. Sección de llanta 40 x 10.

Ref.	Código	Alcance cm	Aperura cm	€ / u.
1250904	5040	15	40	52,64
1250906	5050	15	50	55,65
1250907	5060	15	60	58,23
1250909	5080	15	80	63,85
1250911	5100	15	100	68,77
1250930	5120	15	120	72,97



4003 -L Tornillo de apriete con leva



Ref.	Código	Alcance cm	Apertura cm	Sección de llanta	€ / u.
2400006	1526040	13	40	35x8	57,15
2400007	1526060	13	60	35x8	62,27



4003-P Mordaza magnética



Ref.	Código	Sección de llanta	€ / u.
2400008	1529000	35x8	51,05
2400009	1529002	40x10	53,60



4003-U Tornillo de apriete super extra



Ref.	Código	Alcance cm	Apertura cm	Sección de llanta	€ / u.
2400010	1530040	13	40	35x8	68,45



Sargento de apriete modelo K



Cabezas de fundición nodular. Freno antideslizante en cabezal. Sección de llanta 40 x 10.

Ref.	Código	Alcance cm	b cm	€ / u.
1251002	6040	30	40	102,56
1251010	6050	30	50	105,85
1251004	6060	30	60	109,15
1251006	6080	30	80	115,74
1251008	6100	30	100	122,34



4003- UW Tornillo de apriete mango en cruz



Ref.	Código	Alcance cm	Apertura cm	Sección de llanta	€ / u.
2400011	1547030	13	30	35x8	53,18
2400012	1547031	13	30	35x8	53,18
2400013	1547040	13	40	35x8	56,25
2400014	1547041	13	40	35x8	56,25



4003-WV Tornillo de apriete de soldadura



Ref.	Código	Sección de llanta	€ / u.
2400015	1543030	40x10	90,31
2400016	1543031	40x10	90,31



4003-WV Tornillo de apriete de soldadura terminal de masa



Ref.	Código	Alcance cm	Apertura cm	Sección de llanta	€ / u.
2400017	1529022		40	35x8	56,41



Sargento modelo M



Apriete de marquetería. Husillo rosca fina y mango en cruz con gran capacidad de presión. Recomendado para trabajos de metal.

Ref.	Código	Alcance cm	Apertura cm	€ / u.
1251200	1012	12	7	13,04
1251201	1015	15	7	13,95
1251202	1020	20	7	14,91
1251204	1025	25	7	15,94
1251203	1030	30	7	17,17



Sargento de Maxipress R



Cabezales curvos que permite librar bordes y resaltes. Cabezales de fundición revestidos con pintura Epoxy. Dispositivo posicionador y anticaída en brazo móvil. Llanta de acero laminado 40x10 de alta resistencia (90kg.mm²) Mango ergonómico multiposición y recambiable. Hendiduras en el brazo fijo para el amarre de tubos, perfiles, etc. . Orificio para engrasar el mecanismo

Ref.	Código	Alcance cm	Apertura cm	€ / u.
21093010	61030	15	3	59,43
21093011	61040	15	4	63,39
21093012	61050	15	5	67,01
21093013	61060	15	6	70,12
21093014	61080	15	8	76,87
21093015	61100	15	10	82,80
21093016	61120	15	12	87,87
21093017	61150	15	15	95,53
21093018	61200	15	20	110,08



Sargento de acero forjado modelo PAL



Palanca de apriete rápido.

Ref.	Código	Alcance cm	Apertura cm	€ / u.
1251500	30612	12	6	34,53
1251501	30616	16	8	37,91
1251502	30620	20	10	53,32
1251503	30625	25	12	58,80
1251504	30630	40	12	60,84



Quick PAL



Mordazas y palanca de aluminio. Sistema de carraca de acero. Barra de acero al carbono templada. Protectores con sistema de anti-perdida en las dos mordazas. Liberación de presión fácil.

Ref.	Código	Apertura	Peso kg	€ / u.
8001525	30820	15	0.63	36,36
8001526	30821	30	0.7	41,84



Sargento de Maxipress M



Émbolo de avance recto con rosca fina y protegida. Mango hergonómico abatable e intercambiable. Superficie de presión con hendidura en V para tubos y perfiles. Recomendado para trabajos como soldadura, escayola, etc. Barra de acero cincado y freno anti-deslizante en el cabezal móvil. Llanta 18x7

Ref.	Código	Alcance cm	b cm	€ / u.
21093019	1612	7	12	18,80
21093020	1615	7	15	19,36
21093021	1620	7	20	20,29
21093022	1625	7	25	21,20
21093023	1630	7	30	22,09



503-H2 Tornillo de apriete hidráulico



Ref.	Código	Alcance cm	Apertura cm	Sección de llanta	€ / u.
2400018	1538030	13	30	35x8	128,53



Maxi Quick



Sistema patentado Easy Grip: más presión con menos esfuerzo. Zapatas. Lanta 20x5 antideslizantes extra largas. Liberación progresiva en dos pasos

Ref.	Código	Alcance cm	Apertura cm	€ / u.
21093026	52691	9,4	15	46,80
21093027	52692	9,4	30	49,68
21093028	52693	9,4	45	55,83
21093029	52694	9,4	60	59,53
21093030	52695	9,4	90	66,51
21093031	52696	9,4	125	81,40



Mordaza Quick Single



Ref.	Código	Alcance cm	Apertura cm	Sección de llanta	€ / u.
2400019	1614015	8	15	20x6	23,79
2400020	1614030	8	30	20x6	26,43
2400021	1614045	8	45	20x6	28,81
2400022	1614060	8	60	20x6	30,99



QCB - Mordaza rápida 200 kg. de fuerza



La gama llega hasta una longitud de 1250 mm. La mordaza QCB tiene una fuerza de 200 kgs. Almohadillas de agarre intercambiables con 2 componentes diferentes, las almohadillas estándar son medianas. Mecanismo con gatillo de velocidad variable que incrementa la fuerza cuando la cabeza entra en contacto con la pieza. La mordaza QCB al ser reversible puede ser utilizada como espaciador

Ref.	Código	Longitud mm	€ / u.
1277950	QCB-150	150	31,64
1277951	QCB-300	300	33,92
1277952	QCB-450	450	36,22
1277953	QCB-600	600	38,88
1277954	QCB-900	900	42,50
1277955	QCB-1250	1250	50,99

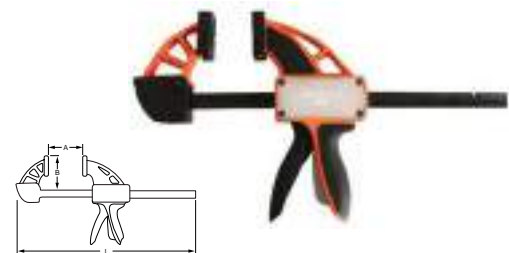

QCG - Mordaza rápida 125 kg. de fuerza



Ref.	Código	Longitud mm	€ / u.
1277900	QCG-150	150	20,99
1277901	QCG-300	300	23,89



Quick PIHER



Aprietos de una sola mano. Sistema patentado Easy Grip: más presión con menos esfuerzo. Zapatillas antideslizantes extra largas. Liberación progresiva en dos pasos. Llanta 20x5.

Ref.	Código	Alcance cm	Apertura cm	€ / u.
21093032	52615	9,4	15	23,20
21093033	52630	9,4	30	25,86
21093034	52645	9,4	45	27,61
21093035	52660	9,4	60	29,15
21093036	52415	6	6	17,24
21093037	52430	6	6	18,68
21093038	52015	10	10	23,20
21093039	52016	10	10	25,04
21093040	52101	15	15	19,91
21093041	52103	15	15	21,96
21093042	30901	8	16	15,93
21093043	30903	8	30	17,65



Mordaza coaxial



Ref.	Código	Alcance cm	Apertura cm	Sección de llanta	€ / u.
2400023	1615015	8,5	15	20x6	32,51
2400024	1615030	8,5	30	20x6	35,17
2400025	1615045	8,5	45	20x6	38,04
2400026	1616020	9,5	20	20x6	35,42
2400027	1616030	9,5	30	20x6	37,21



Pinza metálica de sujeción



Ref.	Código	Alcance cm	Apertura cm	Peso kg	€ / u.
1202110	57025	3	2,5	0,05	2,10
1202111	57050	5	5	0,16	3,05



Pinza profesional metálica



Ref.	Código	Alcance cm	Apertura cm	Material	€ / u.
1278403	30007	3	3,5	Metal	2,15
1278404	30008	4,5	5,5	Metal	4,09
1278405	30009	7	8,5	Metal	7,27



Pinza regulable



Ref.	Código	Alcance cm	Apertura cm	Material	€/u.
21093024	30910	3	3.5	Plástico	4,14
21093025	30911	5	6	Plástico	5,87



Lima de diamante D 126



DF 2601. Plana paralela



DF 2607. Triangular



DF 2610. Cuadrada

DF 2602. Media caña



DF 2608. Cuadrada

Código	Ref.	€/u.	Ref.	€/u.	Anchura x Grosor	Longitud mm	Longitud útil mm
DF 2601	452000	73,34	452100	73,34	10,3 x 2,8	215	100
DF 2602	452001	73,34	452101	73,34	12,5 x 3,8	215	100
DF 2607	452002	73,34	452102	73,34	10	215	100
DF 2608	452003	64,65	452103	64,65	5,5 x 5,5	215	100
DF 2610	452004	64,65	452104	64,65	6,7	215	100

Lima de diamante D 25



Código	Ref.	€/u.	Ref.	€/u.	Ref.	€/u.	Ref.	€/u.	Anchura x Grosor	Longitud mm	Longitud útil mm
DF 3608	452300	34,40	452200	34,40	452500	34,40	452400	34,40	4,2 x 1,5	140	40
DF 3610	452302	34,40			452502	34,40	452402	34,40	4,0 x 1,2	140	40
DF 3614	452303	34,40			452503	34,40	452403	34,40	3	140	40
DF 3617	452304	34,40	452204	34,40	452504	34,40	452404	34,40	4,0 x 1,2	140	40
DF 3619	452305	34,40			452505	34,40	452405	34,40	2,0 x 2,0	140	40
DF 3621	452306	34,40			452506	34,40	452406	34,40	1,8	140	40

4004 - Lima mecánico redonda. Con mango



MECANICO: Para trabajos de repasado, ailado, raspado y acabado en talleres mecánicos e industria en general. Fabricadas con Acero Especial Bellota. Forjadas en una sola pieza, irrompibles. Tratamiento térmico 3+ para alargar la vida útil de la herramienta: no se rompe, no se deforma, no se desgasta. Nivel de dureza estudiado para cada lima en función del trabajo a realizar para conseguir la máxima duración. Dentado uniforme en función del tipo de picado para obtener el mejor resultado.



Ref.	Código	Longitud mm	€/u.	Ref.	Código	Longitud mm	€/u.
1200125	4004-4 BAS. MB	100	8,68	1200132	4004-8 ENT. MB	200	11,55
1200126	4004-6 BAS. MB	150	10,27	1200133	4004-10 ENT. MB	250	15,09
1200127	4004-8 BAS. MB	200	11,38	1200135	4004-4 FIN. MB	100	8,95
1200128	4004-10 BAS. MB	250	15,21	1200136	4004-6 FIN. MB	150	10,82
1200130	4004-4 ENT. MB	100	8,64	1200137	4004-8 FIN. MB	200	12,55
1200131	4004-6 ENT. MB	150	10,23	1200138	4004-10 FIN. MB	250	16,54

4004 - Lima mecánico redonda. Sin mango



MECANICO: Para trabajos de repasado, ailado, raspado y acabado en talleres mecánicos e industria en general. Fabricadas con Acero Especial Bellota. Forjadas en una sola pieza, irrompibles. Tratamiento térmico 3+ para alargar la vida útil de la herramienta: no se rompe, no se deforma, no se desgasta. Nivel de dureza estudiado para cada lima en función del trabajo a realizar para conseguir la máxima duración. Dentado uniforme en función del tipo de picado para obtener el mejor resultado.



Ref.	Código	Longitud mm	€/ u.
1200110	4004-4 BAS.	100	6,59
1200111	4004-6 BAS.	150	8,32
1200112	4004-8 BAS.	200	9,55
1200113	4004-10 BAS.	250	13,23
1200114	4004-12 BAS.	300	17,06
1200115	4004-4 ENT.	100	6,70
1200116	4004-6 ENT.	150	8,37
1200117	4004-8 ENT.	200	9,85

Ref.	Código	Longitud mm	€/ u.
1200118	4004-10 ENT.	250	13,46
1200119	4004-12 ENT.	300	18,11
1200120	4004-4 FIN.	100	7,17
1200121	4004-6 FIN.	150	8,92
1200122	4004-8 FIN.	200	10,94
1200123	4004-10 FIN.	250	14,70
1200124	4004-12 FIN.	300	19,14

4005 - Lima mecánico triangular. Sin mango



MECANICO: Para trabajos de repasado, ailado, raspado y acabado en talleres mecánicos e industria en general. Fabricadas con Acero Especial Bellota. Forjadas en una sola pieza, irrompibles. Tratamiento térmico 3+ para alargar la vida útil de la herramienta: no se rompe, no se deforma, no se desgasta. Nivel de dureza estudiado para cada lima en función del trabajo a realizar para conseguir la máxima duración. Dentado uniforme en función del tipo de picado para obtener el mejor resultado.



Ref.	Código	Longitud mm	€/ u.
1200140	4005-4 BAS.	100	7,04
1200141	4005-6 BAS.	150	9,43
1200142	4005-8 BAS.	200	11,88
1200143	4005-10 BAS.	250	17,06
1200144	4005-12 BAS.	300	23,02
1200145	4005-4 ENT.	100	7,27
1200146	4005-6 ENT.	150	9,78
1200147	4005-8 ENT.	200	12,54

Ref.	Código	Longitud mm	€/ u.
1200148	4005-10 ENT.	250	18,21
1200149	4005-12 ENT.	300	24,21
1200150	4005-4 FIN.	100	7,79
1200151	4005-6 FIN.	150	10,75
1200152	4005-8 FIN.	200	13,39
1200153	4005-10 FIN.	250	19,48
1200154	4005-12 FIN.	300	25,82

4005 - Lima mecánico triangular. Con mango



MECANICO: Para trabajos de repasado, ailado, raspado y acabado en talleres mecánicos e industria en general. Fabricadas con Acero Especial Bellota. Forjadas en una sola pieza, irrompibles. Tratamiento térmico 3+ para alargar la vida útil de la herramienta: no se rompe, no se deforma, no se desgasta. Nivel de dureza estudiado para cada lima en función del trabajo a realizar para conseguir la máxima duración. Dentado uniforme en función del tipo de picado para obtener el mejor resultado.



Ref.	Código	Longitud mm	€/ u.
1200155	4005-6 BAS. MB	100	11,34
1200156	4005-8 BAS. MB	150	13,69
1200157	4005-10 BAS. MB	200	18,74
1200160	4005-4 ENT. MB	100	8,96
1200161	4005-6 ENT. MB	150	11,55

Ref.	Código	Longitud mm	€/ u.
1200162	4005-8 ENT. MB	200	13,84
1200163	4005-10 ENT. MB	250	19,50
1200165	4005-6 FIN. MB	100	12,33
1200166	4005-8 FIN. MB	150	15,21
1200167	4005-10 FIN. MB	200	20,82

4006 - Lima mecánico cuadrada. Sin mango



MECANICO: Para trabajos de repasado, ailado, raspado y acabado en talleres mecánicos e industria en general. Fabricadas con Acero Especial Bellota. Forjadas en una sola pieza, irrompibles. Tratamiento térmico 3+ para alargar la vida útil de la herramienta: no se rompe, no se deforma, no se desgasta. Nivel de dureza estudiado para cada lima en función del trabajo a realizar para conseguir la máxima duración. Dentado uniforme en función del tipo de picado para obtener el mejor resultado.



Ref.	Código	Longitud mm	€ / u.
1200170	4006-4 BAS.	100	8,48
1200171	4006-6 BAS.	150	9,54
1200172	4006-8 BAS.	200	10,94
1200173	4006-10 BAS.	250	14,39
1200174	4006-12 BAS.	300	19,48
1200175	4006-4 ENT.	100	8,63
1200176	4006-6 ENT.	150	9,84

Ref.	Código	Longitud mm	€ / u.
1200177	4006-8 ENT.	200	11,32
1200178	4006-10 ENT.	250	15,52
1200179	4006-12 ENT.	300	20,29
1200180	4006-4 FIN.	100	8,82
1200181	4006-6 FIN.	150	10,52
1200182	4006-8 FIN.	200	12,14
1200183	4006-12 FIN.	300	21,75

4006 - Lima mecánico cuadrada. Con mango



MECANICO: Para trabajos de repasado, ailado, raspado y acabado en talleres mecánicos e industria en general. Fabricadas con Acero Especial Bellota. Forjadas en una sola pieza, irrompibles. Tratamiento térmico 3+ para alargar la vida útil de la herramienta: no se rompe, no se deforma, no se desgasta. Nivel de dureza estudiado para cada lima en función del trabajo a realizar para conseguir la máxima duración. Dentado uniforme en función del tipo de picado para obtener el mejor resultado.



Ref.	Código	Longitud mm	€ / u.
1200184	4006-4 BAS. MB	100	10,50
1200185	4006-6 BAS. MB	150	11,91
1200186	4006-8 BAS. MB	200	13,47
1200187	4006-10 BAS. MB	250	16,35
1200189	4006-4 ENT. MB	100	10,60
1200190	4006-6 ENT. MB	150	11,98

Ref.	Código	Longitud mm	€ / u.
1200191	4006-8 ENT. MB	200	13,85
1200192	4006-10 ENT. MB	250	17,08
1200194	4006-4 FIN. MB	100	10,77
1200195	4006-6 FIN. MB	150	12,33
1200196	4006-8 FIN. MB	200	13,90
1200197	4006-10 FIN. MB	300	18,36

4007 - Lima mecánico plana delgada



MECANICO: Para trabajos de repasado, ailado, raspado y acabado en talleres mecánicos e industria en general. Fabricadas con Acero Especial Bellota. Forjadas en una sola pieza, irrompibles. Tratamiento térmico 3+ para alargar la vida útil de la herramienta: no se rompe, no se deforma, no se desgasta. Nivel de dureza estudiado para cada lima en función del trabajo a realizar para conseguir la máxima duración. Dentado uniforme en función del tipo de picado para obtener el mejor resultado.



Ref.	Código	Longitud mm	€ / u.
1252500	4007-6 BAS.	150	10,99
1252502	4007-6 ENT.	150	11,32
1252504	4007-6 FIN.	150	11,78

4101 - Escofina mediacaña carpintero



Para trabajos en carpintería de madera. Fabricadas con Acero Especial Bellota. Forjadas en una sola pieza, irrompibles. Tratamiento térmico 3+ para alargar la vida útil de la herramienta: no se rompe, no se deforma, no se desgasta. Nivel de dureza estudiado para cada lima en función del trabajo a realizar para conseguir la máxima duración. Dentado uniforme en función del tipo de picado para obtener el mejor resultado.



Ref.	Código	Longitud mm	€/ u.
1252600	4101-6 BAS.	150	17,58
1252601	4101-8 BAS.	200	19,56
1252602	4101-10 BAS.	250	23,06
1252603	4101-12 BAS.	300	27,58
1252604	4101-6 ENT.	150	17,59
1252605	4101-8 ENT.	200	20,58

Ref.	Código	Longitud mm	€/ u.
1252606	4101-10 ENT.	250	26,70
1252607	4101-12 ENT.	300	31,17
1252608	4101-6 FIN.	150	18,70
1252609	4101-8 FIN.	200	25,01
1252610	4101-10 FIN.	250	31,56
1252611	4101-12 FIN.	300	36,63

4077 - Lima aguja



Para trabajos en carpintería de madera. Fabricadas con Acero Especial Bellota. Forjadas en una sola pieza, irrompibles. Tratamiento térmico 3+ para alargar la vida útil de la herramienta: no se rompe, no se deforma, no se desgasta. Nivel de dureza estudiado para cada lima en función del trabajo a realizar para conseguir la máxima duración. Dentado uniforme en función del tipo de picado para obtener el mejor resultado.



Ref.	Código	€/ u.
1252800	4077-16	104,57

4050 - Lima motosierra



Fabricadas con Acero Especial Bellota. Forjadas en una sola pieza, irrompibles. Tratamiento térmico 3+ para alargar la vida útil de la herramienta: no se rompe, no se deforma, no se desgasta. Nivel de dureza estudiado para cada lima en función del trabajo a realizar para conseguir la máxima duración. Dentado uniforme en función del tipo de picado para obtener el mejor resultado.



Ref.	Código	Longitud mm	€/ u.
1252700	4050-8x4,0	200	1,56
1252701	4050-8x4,8	200	1,56

Ref.	Código	Longitud mm	€/ u.
1252702	4050-8x5,5	200	1,56
1252704	4050-8x4,5	200	1,56

4104 - Lima redonda



Para trabajos en carpintería de madera. Fabricadas con Acero Especial Bellota. Forjadas en una sola pieza, irrompibles. Tratamiento térmico 3+ para alargar la vida útil de la herramienta: no se rompe, no se deforma, no se desgasta. Nivel de dureza estudiado para cada lima en función del trabajo a realizar para conseguir la máxima duración. Dentado uniforme en función del tipo de picado para obtener el mejor resultado.



Ref.	Código	Longitud mm	€/ u.
1252910	4104-6 BAS.	150	9,21
1252902	4104-10 BAS.	250	15,45
1252903	4104-6 ENT.	150	10,24

Ref.	Código	Longitud mm	€/ u.
1252904	4104-8 ENT.	200	13,72
1252905	4104-10 ENT.	250	17,03

5200 - Maza de cara recta



Fabricados con Acero Especial Bellota. Forjados en una sola pieza, irrompibles. Tratamiento térmico 3+ para alargar la vida útil de la herramienta: no se rompe, no se deforma, no se desgasta.

Ref.	Código	Grs.	Longitud L	€/u.
1253200	5200-2	2000	600	38,79
1253201	5200-3	3000	600	46,60
1253202	5200-4	4000	700	56,99
1253203	5200-5	5000	800	68,51
1253204	5200-6	6000	800	79,02
1253205	5200-8	8000	900	97,40



NS500 - Maza T/Alemán antichispa



Maza anti-chispa con cabeza de aluminio bronce y mango de fibra de vidrio

Ref.	Código	Grs.	Mango	€/u.
2400390	NS500-1000-FB	1000	Fibra vidrio	155,44
2400391	NS500-1500-FB	1500	Fibra vidrio	179,24
2400392	NS500-2000	2000	Madera	271,58
2400393	NS500-2000-FB	2000	Fibra vidrio	219,47
2400394	NS500-2500	2500	Madera	339,38
2400395	NS500-2500-FB	2500	Fibra vidrio	275,28
2400396	NS500-3000	3000	Madera	407,18
2400397	NS500-3000-FB	3000	Fibra vidrio	310,59
2400398	NS500-3500-FB	2500	Fibra vidrio	438,92
2400399	NS500-4000	4000	Madera	539,76



Maza antichispa acotillo



Ref.	Código	Modelo	Peso cabeza grs.	Longitud mm	Peso total grs.	€/u.
1200845	FG0069A	H-69	1360	380	1570	170,45
1200846	FG0070A	H-70	2270	840	3220	247,11
1200847	FG0071A	H-71	3400	840	4300	338,07
1200848	FG0072A	H-72	4540	840	5030	391,84
1200849	FG0073A	H-73	6800	840	7300	661,99
1200850	FG0074A	H-74	8170	840	8740	1.002,74

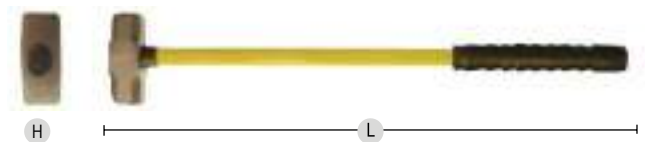

5308 - Maceta de albañil



Para golpeo de materiales diversos en obra y apertura de rozas junto con cincel o cortafuero. Nuevo diseño de mangos: gran comodidad de agarre y excelente sensación en la mano. Nuevo diseño de ojos: ovalados para mejorar la comodidad durante el trabajo evitando el giro del mango.

Ref.	Código	A mm	B mm	Peso grs.	€/u.
1253400	5308-0 N	108	34,5	700	18,44
1253401	5308-A N	123	38	1.000	20,22
1253402	5308-B N	133	43	1.400	22,64



5308 - Maceta de albañil mango fibra carbono



Mango ovalado más completo y cómodo de fibra de carbono, resistente, ergonómico y con estrías laterales para que no se deslice de carbono, resistente, ergonómico y con estrías laterales para que no se deslice.

Ref.	Código	A mm	B mm	C mm	Peso grs.	€ / u.
1465308	5308-0 CF	270	108	34	700	21,09
1465309	5308-A CF	270	123	39	1.000	23,43
1465311	5308-B CF	270	133	43	1.400	26,30

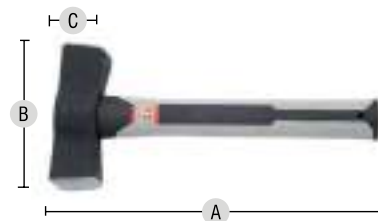

Maceta antichispa doble cabeza



Ref.	Código	Modelo	Peso cabeza grs.	Longitud mm	Peso total grs.	€ / u.
1200840	FG0321A	H-321	910	255	1185	147,59
1200841	FG0323A	H-323	1820	255	2020	228,44

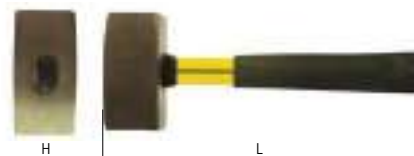

5308 - Maceta sin templar mango fibra carbono



Mango ovalado más completo y cómodo de fibra de carbono, resistente, ergonómico y con estrías laterales para que no se deslice de carbono, resistente, ergonómico y con estrías laterales para que no se deslice.

Ref.	Código	Longitud mm	Peso grs.	€ / u.
1200094	5308-A 0 HRc CF	270	1.000	24,14



Cuña de golpe anti-chispa



Ref.	Código	Denominación	Medida mm	Longitud mm	Peso grs.	€ / u.
8001108	8AMP2503A	Cuña de pestaña 25x13x150 mp25	25x13	150	200	29,42
8001109	8AMP3205A	Cuña de pestaña 32x13x180	32x13	180	300	40,35
8001110	8AMP3804A	Cuña de pestaña 38x19x150 mp38	38x19	150	400	48,08
8001111	8AMP3807A	Cuña de pestaña 38x41x200 mp38	38x41	200	1.300	96,31
8001112	8AMP3808A	Cuña de pestaña 38x25x200	38x25	200	800	75,64
8001113	8AMP5006A	Cuña de pestaña 50x19x180	50x19	180	730	70,09
8001114	8AMP5009A	Cuña de pestaña 50x19x200 mm.	50x19	200	805	79,66
8001115	8AMP5010A	Cuña de pestaña 50x32x215	50x32	215	1.400	105,58



Cuña de golpe anti-chispa



Cuña anti-chispa de aluminio bronce

Ref.	Código	Medida mm	€ / u.
2400400	NS600-80-13	13x80	9,87
2400401	NS600-100-50	50x100	36,57
2400402	NS600-135-50	50x135	69,50
2400403	NS600-150-25	25x150	32,92
2400404	NS600-150-30	30x140	29,28
2400405	NS600-150-40	30x150	36,57
2400406	NS600-150-50	10x150	62,18
2400407	NS600-180-13	13x180	29,28
2400408	NS600-180-32	32x180	42,06
2400409	NS600-180-50	50x180	93,27
2400410	NS600-200-20	20x200	82,30
2400411	NS600-200-30	30x200	100,58
2400412	NS600-200-40	40x200	147,65
2400413	NS600-200-50	50x200	72,46
2400414	NS600-230-40	40x230	106,08
2400415	NS600-250-40	40x250	164,59
2400416	NS600-300-50	50x300	321,88



Cuña de golpe anti-chispa



Cuña anti-chispa de Cobre Berilio

Ref.	Código	Medida mm	€ / u.
2400417	NSB600-80-13	13x80	13,34
2400418	NSB600-100-50	50x100	49,38
2400419	NSB600-135-50	50x135	93,82
2400420	NSB600-150-25	25x150	44,45
2400421	NSB600-150-30	30x140	47,27
2400422	NSB600-150-40	30x150	51,09
2400423	NSB600-150-50	10x150	83,95
2400424	NSB600-180-13	13x180	38,11
2400425	NSB600-180-32	32x180	56,78
2400426	NSB600-180-50	50x180	125,92
2400427	NSB600-200-20	20x200	111,11
2400428	NSB600-200-30	30x200	135,79
2400429	NSB600-200-40	40x200	211,26
2400430	NSB600-200-50	50x200	99,02
2400431	NSB600-230-40	40x230	143,20
2400432	NSB600-250-40	40x250	222,20
2400433	NSB600-300-50	50x300	434,54



39INOX Cuña de acero inoxidable



Cuña anti-chispa de Cobre Berilio

Ref.	Código	L mm	€ / u.
21020001	390310	100	31,50
21020002	390315	150	60,00
21020003	390320	200	180,50



5931 - Alcotana



Extracción de puntas desde 0-1 mm. Cl: modelos con imán. Madera de haya.

- Nuevo diseño de mangos: gran comodidad de agarre y excelente sensación en la mano. - Nuevo diseño de ojos: ovalados para mejorar la comodidad durante el trabajo evitando el giro del mango.

Ref.	Código	Descripción	A mm	Peso grs.	€ / u.
1200092	5931-A N	Pala-Martillo	188	520	26,18
1200093	5932-0 N	Hacha-Pala	265	500	25,24



8017 - Martillo encofrador con imán



Martillo encofrador profesional con cabeza de acero forjado (control de durezas en las zonas de golpeo y uñas), extracción de puntas de 0-1 mm. Mango de madera de haya certificada PEFC. Garantía en la unión cónica (seguridad). Para trabajos de encofrado.

Ref.	Código	Longitud del mango (en cm)	Imán kg	€/ u.
2400078	8017-0 CI	45	0.25	22,29
2400079	8017-A CI	45	0.31	22,42



8017 - Martillo encofrador



Ojos ovalados para mejorar la comodidad durante el trabajo evitando el giro del mango.

Ref.	Código	A mm	B mm	€/ u.
1253902	8017-B	140	26	24,45
1253903	8017-C	148	28	26,04
1253904	8017-D	157	30	29,66
1254251	8030 CI	172	30	26,12



8011 - Martillo mecánico de bola



Para golpeo de piezas, principalmente chapa o acero: ensamblajes, remaches, puntos de soldadura y ajuste mecánicos en general.

Ref.	Código	A mm	B mm	€/ u.
1254000	8011-A	80	25	16,27
1254001	8011-B	90	27	16,85
1254002	8011-C	98	30	17,52
1254003	8011-D	108	32	18,95
1254004	8011-E	118	34	20,73
1254005	8011-F	128	36	22,51
1254006	8011-G	138	38	24,44
1254007	8011-H	145	40	27,75
1254008	8011-C CF	98	30	29,19
1254009	8011-D CF	108	32	31,63
1254010	8011-E CF	118	34	34,52
1254011	8011-F CF	128	36	37,51
1254012	8011-G CF	138	38	40,67



8011 - Martillo mecánico sin templar de bola mango fibra carbono



Nuevos modelos sin templar: para golpear materiales de gran dureza y evitar la aparición de esquirlas. MÁXIMA SEGURIDAD. Durante el golpeo el martillo irá perdiendo su forma, pero no su masa, lo que permitirá seguir trabajando asegurando la máxima seguridad del usuario.

Ref.	Código	A mm	Peso grs.	€/ u.
1200095	8011-F 0 HRc CF	358	870	37,98



9011 - Martillo de bola



Martillo con cabeza cilíndrica y superficie de golpe plana, mango de fibra de vidrio.

Ref.	Código	Longitud mm	Peso cabeza g	€ / u.
8005005	9011 B	330	350	4,93
8005006	9011 C	330	450	5,54
8005007	9011 D	355	600	7,00
8005008	9011 F	355	900	8,51
8005009	9011 G	378	1125	9,87
8005010	9011 H	378	1350	11,20



1377INOX Martillo de bola, de acero inoxidable



Alta resistencia a la corrosión. Evita la oxidación incorrecta. Características mecánicas sobresalientes. Acero inoxidable AISI 421

Ref.	Código	Peso g	L mm	€ / u.
21020004	13770623	650	220	62,00
21020005	13770634	770	220	89,00



TAH479 - Martillo de bola para trabajo en altura



Martillos de bola con lazo de alambre y mango de nogal americano

Ref.	Código	Longitud mm	Peso cabeza g	€ / u.
2400434	TAH479-16	350	450	62,93
2400435	TAH479-32	400	900	68,89



3625S - Martillo de boca nylon mango metálico



Ref.	Código	A mm	B mm	C mm	€ / u.
1254100	3625S-28	80	255	28	23,50
1254101	3625S-35	100	285	35	31,34
1254102	3625S-44	125	300	44	44,37



1370-INOX Martillo de mecánico tipo alemán, de acero inoxidable



Alta resistencia a la corrosión. Evita la oxidación incorrecta. Características mecánicas sobresalientes. Acero inoxidable AISI 420

Ref.	Código	T g	A mm	L mm	L1 mm	€ / u.
8005205	13700375	500	25	240	101	105,00



NSB504- Martillo de mecánico tipo alemán, antichispa



Martillo tipo alemán, anti-chispa, con cabeza de Cobre Berilio y mango de fibra de vidrio

Ref.	Código	Peso cabeza g	€/ u.
2400436	NSB504-100-FB	100	209,85
2400437	NSB504-200-FB	200	86,40
2400438	NSB504-300-FB	300	106,14
2400439	NSB504-500-FB	500	133,32
2400440	NSB504-800-FB	800	172,82
2400441	NSB504-1000-FB	1000	209,85
2400442	NSB504-1500-FB	1500	283,93
2400443	NSB504-2000-FB	2000	343,18



3625W - Martillo de boca nylon mango de madera



Ref.	Código	A mm	B mm	Longitud mm	€/ u.
1254200	3625W-22	22	60	150	11,01
1254201	3625W-28	28	80	275	15,74
1254202	3625W-35	35	100	300	19,83
1254203	3625W-44	44	120	360	28,94
1254204	3625W-55	55	140	400	55,66



3625WL - Boca de nylon



Ref.	Código	A mm	B mm	€/ u.
1254605	3625WL-22	22	12	4,19
1254601	3625WL-28	28	19	4,65
1254602	3625WL-35	35	22	5,66

Ref.	Código	A mm	B mm	€/ u.
1254603	3625WL-44	44	27	6,19
1254604	3625WL-55	55	32	8,19

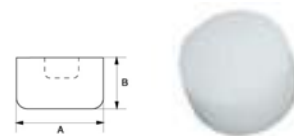

Martillo de boca nylon, mango de madera



Martillo con boca de nylon recambiable, mango de madera

Ref.	Código	A mm	B mm	Longitud mm	€/ u.
8004996	AS104-28	28	80	275	11,70
8004997	AS107-35	34	100	300	16,20
8004998	AS110-44	44	120	360	25,65
8004999	AS113-55	55	140	400	39,85



Martillo de boca nylon, mango metálico



Martillo con boca de nylon recambiable, mango metálico

Ref.	Código	A mm	B mm	Longitud mm	€/ u.
8005001	AS117-34	34	100	300	23,00
8005002	AS118-44	44	120	360	32,35



Mazas DUCH n° 4 STRONG



Maza con cuerpo de zamak unido mediante tornillos M10

Ref.	Código	Descripción	Medidas mm	€ / u.
12001390	00100034S	Maza nylon	Ø60 x 158 x 415	76,00

Mazas DUCH n° 4 STRONG. Recambios

Ref.	Código	Descripción	Medidas mm	€ / u.
12001395	00100040S	Boca recambio nylon	Ø60	16,98
12001396	00100043S	mango madera	415	13,30



Martillo antirrebote mango fibra Nupla mod. "Strike Pro"



Boca no intercambiable. Mango compuesto de miles de fibras de vidrio, que aportan solidez y ligereza al mango, aislamiento eléctrico hasta 20.000v.y absorción de las vibraciones derivadas del golpeo.

Ref.	Código	Cabeza Ø mm	Mango tipo	Peso grs.	€ / u.
1460016	NUSTP16	40	H	470	38,90
1460024	NUSTP24	45	H	650	43,78
1460040	NUSTP40	63	H	1.190	65,75



Martillo-Maza antirrebote mango fibra Nupla mod. "Powerdrive"



Mango compuesto de miles de fibras de vidrio, que aportan solidez y ligereza al mango, aislamiento eléctrico hasta 20.000v.y absorción de las vibraciones derivadas del golpeo.

Ref.	Código	Cabeza Ø mm	Mango tipo	Peso grs.	€ / u.
1460051	NUSF1C	40	C	650	86,56
1460052	NUSF2C	50	C	865	101,38
1460053	NUSF3C	60	C	1.165	134,62



122 - Martillo antirrebote



Martillo con boca de nylon anti rebote, recambiable, mango de madera

Ref.	Código	Diámetro de cabeza	Anchura de cabeza mm	Longitud mm	€ / u.
8005605	AS116-35	35	110	300	35,46
8005606	AS-116-50	50	120	370	49,02



8053 - Maza de goma



Cabeza fabricada en goma de caucho isopreno de alta calidad: máxima durabilidad y resistencia. • Sin olor, sin cristalización. • Excelente rebote que asegura la precisión y comodidad de uso durante el golpeo, además de la protección del material cerámico con el que se trabaje. • Mangos de madera de haya barnizados, ligeros y de tacto agradable. Certificados PEFC.

Ref.	Código	A mm	B mm	C mm	€ / u.
1278600	8053-250	307	90	54	11,19
1278601	8053-500	340	113	64	14,11
1278602	8053-750	381	127	74	18,92



8054 - Maza de goma



Cabeza fabricada en goma de caucho isopreno de alta calidad: máxima duración y resistencia. • Sin olor, sin cristalización. • Excelente rebote que asegura la precisión y comodidad de uso durante el golpeo, además de la protección del material cerámico con el que se trabaja. • Mangos de madera de haya barnizados, ligeros y de tacto agradable. Certificados PEFC.

Ref.	Código	A mm	B mm	C mm	€/ u.
1279650	8054-250	307	90	54	11,99
1279651	8054-500	340	113	64	14,87
1279652	8054-750	381	127	74	19,86

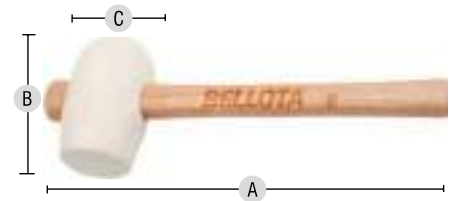

3625RM - Maza de goma



Ref.	Código	A mm	B mm	Longitud mm	€/ u.
1254500	3625RM-55	55	90	320	10,91
1254501	3625RM-65	65	115	340	11,78
1254502	3625RM-75	75	125	360	14,12
1254503	3625RM-90	90	139	360	17,15



Maza de goma



Conforme a DIN 5128-90, dos superficies percutoras

Ref.	Código	A mm	B mm	C mm	€/ u.
8005003	AS120-65	340	113	65	9,16
8005004	AS121-75	380	125	75	12,10



8251 - Cincel - cortafrió cuerpo plano



Fabricados con Acero Especial Bellota: Cromo vanadio. Tratamiento térmico 3+ para alargar la vida útil de la herramienta: no se rompe, no se deforma, no se desgasta. Tratamiento diferenciado en tres zonas: cabeza, cuerpo y punta, y exhaustivo control de las durezas resultantes para garantizar la nula aparición de esquirlas. Máxima seguridad durante el trabajo. Puntas rectificadas, biseladas y barnizadas. Pintura en base agua. Respeto al medio ambiente. Protector con tres labios para mayor protección de la mano.

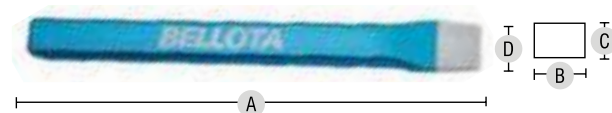

Ref.	Código	A mm	B mm	C mm	d mm	€/ u.
1255000	8251-150	150	17	11	18	8,79
1255001	8251-175	175	18	11	18	9,40
1255002	8251-200	200	22	11	22	10,21
1255003	8251-225	225	22	11	22	11,28

Ref.	Código	A mm	B mm	C mm	d mm	€/ u.
1255004	8251-250	250	25	12	25	12,44
1255005	8251-300	300	25	12	25	13,66
1255006	8251-350	350	25	12	25	15,46
1255007	8251-400	400	25	12	25	17,13

Cinzel plano



De acero de cromo-vanadio templado al aire. Cabeza percusora templada. DIN 6453. Debido al temple y el revenido queda prácticamente excluida la formación de rebordes, bordeados y desconchados. El filo puede reaflarse repetidas veces por medio de un simple amolado en húmedo.

Ref.	Código	A mm	B mm	D mm	€/ u.
8004771	R310 125 1 ASI	125	17	11	7,89
8004772	R310 150 1 ASI	150	17	11	8,58
8004773	R310 175 1 ASI	175	20	12	10,41
8004774	R310 200 1 ASI	200	23	13	11,85
8004775	R310 250 1 ASI	250	23	13	14,79
8004776	R310 300 1 ASI	300	23	13	16,62



5825 CP - Cinzel - cortafrió con protector



Fabricados con Acero Especial Bellota: Cromo vanadio. Tratamiento térmico 3+ para alargar la vida útil de la herramienta: no se rompe, no se deforma, no se desgasta. Tratamiento diferenciado en tres zonas: cabeza, cuerpo y punta, y exhaustivo control de las durezas resultantes para garantizar la nula aparición de esquirlas. Máxima seguridad durante el trabajo. Puntas rectificadas, biseladas y barnizadas. Pintura en base agua. Respeto al medio ambiente. Protector con tres labios para mayor protección de la mano.

Ref.	Código	A mm	B mm	d mm	€/ u.
1255100	5825-14x250 CP	250	14	20	14,33
1255101	5825-16x250 CP	250	16	23	14,99
1255102	5825-16x300 CP	300	16	23	15,27
1255103	5825-18x250 CP	250	18	26	15,74
1255104	5825-18x300 CP	300	18	26	16,88
1255105	5825-18x350 CP	350	18	26	17,70
1255106	5825-18x400 CP	400	18	26	18,57

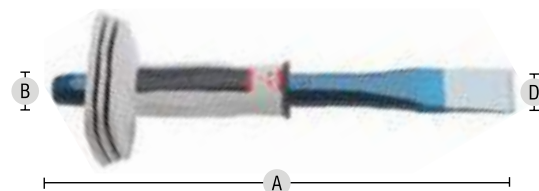

8251 CP - Cinzel - cortafrió con protector



Fabricados con Acero Especial Bellota: Cromo vanadio. Tratamiento térmico 3+ para alargar la vida útil de la herramienta: no se rompe, no se deforma, no se desgasta. Tratamiento diferenciado en tres zonas: cabeza, cuerpo y punta, y exhaustivo control de las durezas resultantes para garantizar la nula aparición de esquirlas. Máxima seguridad durante el trabajo. Con protector.

Ref.	Código	A mm	B mm	C mm	d mm	€/ u.
1255200	8251-250 CP	250	25	12	25	16,13
1255201	8251-300 CP	300	25	12	25	17,58
1255202	8251-350 CP	350	25	12	25	19,12
1255203	8251-400 CP	400	25	12	25	20,89

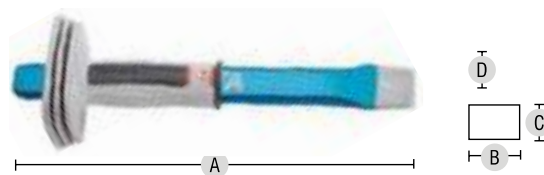

5825 - Cíncel - cortafrió

Fabricados con Acero Especial Bellota: Cromo vanadio. Tratamiento térmico 3+ para alargar la vida útil de la herramienta: no se rompe, no se deforma, no se desgasta. Tratamiento diferenciado en tres zonas: cabeza, cuerpo y punta, y exhaustivo control de las durezas resultantes para garantizar la nula aparición de esquirlas. Máxima seguridad durante el trabajo. Puntas rectificadas, biseladas y barnizadas. Pintura en base agua. Respeto al medio ambiente. Protector con tres labios para mayor protección de la mano.



Ref.	Código	A mm	B mm	d mm	€/ u.
1255301	5825-14x200	200	14	20	9,99
1255302	5825-14x250	250	14	20	10,74
1255304	5825-16x200	200	16	23	10,74
1255305	5825-16x250	250	16	23	11,49
1255306	5825-16x300	300	16	23	11,63
1255307	5825-16x350	350	16	23	12,50

Ref.	Código	A mm	B mm	d mm	€/ u.
1255309	5825-18x250	250	18	26	12,09
1255310	5825-18x300	300	18	26	13,28
1255311	5825-18x350	350	18	26	14,28
1255312	5825-18x400	400	18	26	15,20
1255313	5825-20x300	300	20	30	14,57

Cortafrió



Vástago octogonal. De acero de cromo-vanadio templado al aire. Cabeza percusora templada. DIN 7254 B. Debido al temple y el revenido queda prácticamente excluida la formación de rebordes, bordeados y desconchados. El filo puede reafilarse repetidas veces por medio de un simple amolado en húmedo.

Ref.	Código	A mm	B mm	C mm	€/ u.
8004787	R350 250 1 ASI	250	16	23	12,84
8004788	R350 300 1 ASI	300	18	26	15,45
8004789	R350 400 1 ASI	400	20	30	19,44
8004790	R350 500 1 ASI	500	20	30	25,41



8255 - Cíncel electricista



Para apertura de canales, incluso en zonas de difícil acceso.

Ref.	Código	A mm	B mm	C mm	d mm	€/ u.
1255400	8255-8x200	200	6	6	8	10,02
1255401	8255-10x200	200	8	8	10	10,06
1255402	8255-10x250	250	8	8	10	10,29
1255403	8255-12x200	200	8	8	12	10,29
1255404	8255-12x250	250	8	8	12	10,63
1255405	8255-12x300	300	8	8	12	10,88



8241 - Buril mecánico



Para eliminar puntos de soldadura y otros restos.

Ref.	Código	A mm	B mm	C mm	€/ u.
1255501	8241-175	175	18	9	17,84
1255502	8241-200	200	22	11	19,55
1255503	8241-250	250	25	12	21,56





Buril

De acero de cromo-vanadio templado al aire. Cabeza percusora templada. DIN 6451. El filo puede reafilarse repetidas veces por medio de un simple amolado en húmedo.

Ref.	Código	A mm	B mm	C mm	€ / u.
8004778	R320 150 1 ASI	150	17	11	9,87
8004780	R320 200 1 ASI	200	20	12	12,54
8004781	R320 250 1 ASI	250	23	13	15,84



Cinzel chapista



De acero de cromo-vanadio templado al aire. Cabeza percusora templada. El filo puede reafilarse repetidas veces por medio de un simple amolado en húmedo.

Ref.	Código	A mm	B mm	C mm	€ / u.
8004791	R380 240 1 ASI	400	26	7	13,50

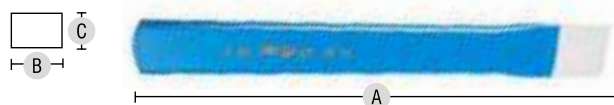

34INOX Cortafrío plano, de acero inoxidable



Alta resistencia a la corrosión Evita la oxidación incorrecta Características mecánicas sobresalientes Acero inoxidable AISI 420

Ref.	Código	L mm	Ø mm	€ / u.
20024759	340318	160	18	49,50
21020000	340320	200	20	73,50



8245 - Cinzel plano



Para eliminar puntos de soldadura y otros restos.

Ref.	Código	A mm	B mm	C mm	€ / u.
1255600	8245-200	200	20	12	11,07
1255601	8245-250	250	20	12	11,50
1255602	8245-300	300	23	13	12,44



8261 - Cinzel chapista



Ref.	Código	A mm	B mm	C mm	d mm	€ / u.
1255800	8261-240	240	26	7	26	14,86



5821 - Puntero construcción octogonal



Para apertura de rozas en operaciones de rotura en general. Para eliminar restos de hormigón u otros materiales en soportes de obra. Fabricados con Acero Especial Bellota: Cromo vanadio. Tratamiento térmico 3+ para alargar la vida útil de la herramienta: no se rompe, no se deforma, no se desgasta. Tratamiento diferenciado en tres zonas: cabeza, cuerpo y punta, y exhaustivo control de las durezas resultantes para garantizar la nula aparición de esquirlas. Máxima seguridad durante el trabajo. Puntas rectificadas, biseladas y barnizadas. Pintura en base agua. Respeto al medio ambiente. Protector con tres labios para mayor protección de la mano.

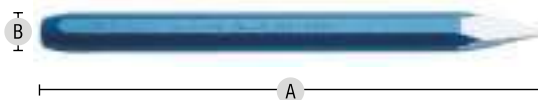

Ref.	Código	A mm	B mm	€ / u.
1256201	5821-14x200	200	14	9,90
1256202	5821-14x250	250	14	10,51
1256217	5821-16x200	200	14	10,31
1256203	5821-16x250	250	14	11,16
1256205	5821-16x300	300	16	11,49

Ref.	Código	A mm	B mm	€ / u.
1256206	5821-16x350	350	16	12,56
1256208	5821-18x250	250	16	11,92
1256209	5821-18x300	300	18	12,92
1256210	5821-18x350	350	18	13,79
1256211	5821-18x400	400	18	14,87

Puntero



Vástago octogonal. De acero de cromo-vanadio templado al aire. Cabeza percursora templada. DIN 7256. Debido al temple y el revenido queda prácticamente excluida la formación de rebordes, bordeados y desconchados. El filo puede reafilearse repetidas veces por medio de un simple amolado en húmedo.

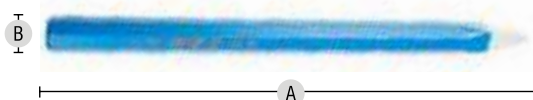

Ref.	Código	A mm	B mm	€ / u.
8004783	R330 250 1 ASI	250	16	12,30
8004784	R330 300 1 ASI	300	18	14,22

Ref.	Código	A mm	B mm	€ / u.
8004785	R330 400 1 ASI	400	20	18,09

5821 CP - Puntero construcción octogonal con protector



Fabricados con Acero Especial Bellota: Cromo vanadio. Tratamiento térmico 3+ para alargar la vida útil de la herramienta: no se rompe, no se deforma, no se desgasta. Tratamiento diferenciado en tres zonas: cabeza, cuerpo y punta, y exhaustivo control de las durezas resultantes para garantizar la nula aparición de esquirlas. Máxima seguridad durante el trabajo. Con protector.

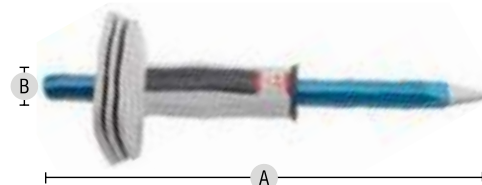

Ref.	Código	A mm	B mm	€ / u.
1256250	5821-14x250 CP	250	14	14,23
1256251	5821-16x250 CP	250	16	14,87
1256252	5821-16x300 CP	300	16	15,22
1256253	5821-18x250 CP	250	18	15,56

Ref.	Código	A mm	B mm	€ / u.
1256255	5821-18x300 CP	300	18	16,69
1256256	5821-18x350 CP	350	18	17,45
1256257	5821-18x400 CP	400	18	18,36

3735 - Granete



Ref.	Código	d mm	Longitud mm	Ø mm	€ / u.
1256301	3735-4-120	10	120	4	5,32
1256302	3735-5-120	12	120	5	6,56



Granete



DIN 725. Vástago octogonal. Punzón de forma cónica. De acero de cromo-vanadio templado al aire. Cabeza percutora templada. Debido al temple y el revenido queda prácticamente excluida la formación de rebordes, bordeados y desconchados.

Ref.	Código	Ø mm	L mm	Ø Mango mm	€ / u.
8004792	R432 120 0 ASI	5	120	12	4,08
8004793	R433 150 0 ASI	5	150	12	4,77



Granete con punta de metal duro



DIN 725. Vástago octogonal. Punzón de forma cónica. De acero de cromo-vanadio templado al aire. Cabeza percutora templada. Punta de metal duro

Ref.	Código	Ø mm	L mm	Ø Mango mm	€ / u.
8005554	R430 121 0 ASI	3	120	10	18,21



3734 - Botador cilíndrico

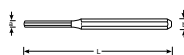

Ref.	Código	d mm	Longitud mm	Ø mm	€ / u.
1256400	3734-2	10	150	2	8,54
1256401	3734-3	10	150	3	8,54
1256402	3734-4	10	150	4	8,54

Ref.	Código	d mm	Longitud mm	Ø mm	€ / u.
1256403	3734-5	10	150	5	8,54
1256404	3734-6	10	150	6	8,54
1256406	3734-8	12	150	8	8,73

Botador cilíndrico



Vástago octogonal. Punzón cilíndrico. De acero de cromo-vanadio templado al aire. Cabeza percutora templada. DIN 6450. Debido al temple y el revenido queda prácticamente excluida la formación de rebordes, bordeados y desconchados.



Ref.	Código	Ø mm	L mm	Ø Mango mm	€ / u.
8004795	R450 002 0 ASI	2	150	10	5,13
8004796	R450 003 0 ASI	3	150	10	5,13
8004797	R450 004 0 ASI	4	150	10	5,40
8004798	R450 005 0 ASI	5	150	10	5,40
8004799	R450 006 0 ASI	6	150	10	5,40

Ref.	Código	Ø mm	L mm	Ø Mango mm	€ / u.
8004800	R450 007 0 ASI	7	150	12	5,73
8004801	R450 008 0 ASI	8	150	12	5,73
8004802	R450 009 0 ASI	9	150	12	5,73
8004803	R450 010 0 ASI	10	150	12	5,73

Juego botadores cilíndricos



Vástago octogonal. Forma de cono cilíndrica. De acero de cromo-vanadio templado al aire. Cabeza percutora templada. DIN 6450. Debido al temple y el revenido queda prácticamente excluida la formación de rebordes, bordeados y desconchados. En caja de chapa de acero.

Ref.	Código	Cantidad	Composición	€ / u.
8004805	R425 160 0 ASI	6	3-4-5-6-8-10	48,69



Juego botadores cilíndricos con manguito guía



Acero de cromo vanadio. Cromado de cinc. Manguitos moleteados. Ribete templado. Nota: Extractor de pasadores Ø 0,9 hasta 3,9 mm con manguitos de dirección sueltos, 5,9 mm con manguitos fijos.

Ref.	Código	Cantidad	Composición	€ / u.
8004806	R457 101 5 ASI	8	0,9-1,4-1,8-2,4-2,8-3,4-3,9-5,9	60,66
8004807	R457 102 5 ASI	8	0,9-1,4-1,8-2,4-2,8-3,4-3,9-5,9	69,36



3734 - Juego botadores cilíndricos



Ref.	Código	Composición mm	Nº piezas	€ / u.
1256800	3734S/6	Ø 2 3 4 5 6 8	9	67,22



3733 - Botador cónico

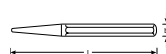

Ref.	Código	d mm	Longitud mm	Ø mm	€ / u.
1256600	3733-2	10	120	2	5,05
1256601	3733-3	10	120	3	5,05
1256602	3733-4	10	120	4	4,95

Ref.	Código	d mm	Longitud mm	Ø mm	€ / u.
1256603	3733-5	10	120	5	4,95
1256604	3733-6	10	120	6	4,95

Sacabocados cilíndricos



Dureza en la boca de 42 HRc.

Ref.	Código	Diámetro x longitud mm	€ / u.	Ref.	Código	Diámetro x longitud mm	€ / u.
1257100	44824	2 x 70	2,26	1257108	44896	10 x 110	4,60
1257101	44834	3 x 70	2,44	1257109	44902	11 x 125	6,26
1257102	44844	4 x 85	2,44	1257110	44904	12 x 130	7,70
1257103	44854	5 x 90	2,55	1257111	44906	13 x 130	7,70
1257104	44864	6 x 95	2,95	1257112	44908	14 x 130	9,03
1257105	44874	7 x 95	3,18	1257113	44910	15 x 130	9,17
1257106	44884	8 x 110	3,77	1257114	44912	16 x 130	10,98
1257107	44894	9 x 110	4,47	1257115	44914	17 x 130	10,98



Juego botadores cónicos



Vástago octogonal. Forma de cono cilíndrica. De acero de cromo-vanadio templado al aire. Cabeza percusora templada. DIN 6450. Debido al temple y el revenido queda prácticamente excluida la formación de rebordes, bordeados y desconchados. En caja de chapa de acero.

Ref.	Código	Cantidad	Composición	€ / u.
8004808	R424 130 0 ASI	6	3-4-5-6-8-10	35,67



Cortadora cerámica



Ideada para trabajar en bloque como una única pieza sin holguras ni fricciones.

Ref.	Código	A mm	B mm	C mm	€ / u.
1200098	TECH 125	1.473	362	230	945,46



Rodel Universal



Mango de acero forjado con sección octogonal muy robusto y resistente. • Rulina de alta calidad de Carburo de Tungsteno muy resistente y duradera, hasta un 25% más de vida útil. • Recubrimiento especial de carbonitruro de titanio para la gama Titanium. Consigue alargar la vida útil de la rulina hasta un 20% respecto al resto de la gama. • Excelente precisión de toda la gama. Proporciones áureas de la medida de 18 mm que permiten una mejor estabilidad y apoyo en el eje de giro.

Ref.	Código	Peso grs.	Tipo de rodel	€ / u.
1200207	RODELXL8	40	XL 8	14,85
1200208	RODELXL10	45	XL 10	16,29
1200209	RODELXL18	55	XL 18	27,76
1200210	RODELXL8T	45	XL Titanium 8	17,79
1200211	RODELXL10T	55	XL Titanium 10	19,21
1200212	RODELXL18T	55	XL Titanium 18	30,63



Cortadora cerámica



Cortadora de cerámica profesional para láminas cerámicas de gran formato (Slab) Lean320, hasta 3200 mm de longitud de corte. Incluye 3 guías de aluminio, 1 carro rayador con rulina especial para gran formato de carburo de tungsteno de diámetro 22mm, 1 separador a rosca (para espesores hasta 12 mm), 1 alicate separador, 4 ventosas para fijar las guías con la cerámica, garantizando un rayado perfecto y una bolsa de transporte. Ligera y precisa para láminas cerámicas de gran formato (Slab), cerámicas finas y porcelánico de hasta 12 mm de espesor. Para el alicatador profesional más exigente.



Ref.	Código	Longitud de corte máxima a 90° (en mm)	Longitud de corte máxima a 45° (en mm)	Espesor máximo de corte (en mm)	€ / u.
2400080	LEAN320	3.390	3.390	12	381,21
2400081	NEO100	1.000	1.000	18	602,14
2400082	NEO130	1.300	1.300	18	753,94
2400083	NEO155	1.550	1.550	18	855,14
2400084	FIT80B	850	850	15	265,38
2400085	FIT100B	1.050	1.050	15	327,11
2400086	FIT120B	1.250	1.185	15	399,74

Puntal



Facil de usar, con zapatas de goma antideslizantes adaptables a ángulos distintos. Nuevos sistema patentado de fijación y ajuste.

Ref.	Código	Apertura máxima cm	Apertura mínima cm	€ / u.
1278550	30010	100	60	39,50
1278551	30011	170	95	44,54
1278552	30012	300	155	48,43



Puntal



PUNTAL 43111 APERTURA 65-115 CM.

Ref.	Código	Apertura cm	€ / u.
2400028	1843111	65-115	40,91
2400029	1843117	101-177	47,26
2400030	1843129	160-290	51,38
2400031	1843136	195-365	58,59



Crucetas, T, cuñas y Niveladores



Sistema de NIVELACIÓN PUSH & LEVEL · Ahorra tiempo: Solo con las manos se nivelan las baldosas de una forma rápida y cómoda. No necesita herramientas adicionales, siendo capaz de llegar a todas las esquinas. Con los calzos en "Cruz" y "T" se reduce el número de calzos a utilizar.

Ref.	Código	Descripción	€ / u.
21017002	LSS005	Calzo PUSH 0,5mm 200u.	24,02
21017003	LSS010	Calzo PUSH 1mm 200u.	24,02
21017004	LSS020	Calzo PUSH 2mm 200u.	24,02
21017005	LSS030	Calzo PUSH 3mm 200u.	24,02
21017006	LSS010CROSS	Calzo PUSH CRUZ 1mm 200u.	24,02



Caballote plegable viga



Caballote plegable y con asa para transporte. Lámina antideslizante en zona de apoyo.

Ref.	Código	Apertura cm	Peso kg	€ / u.
1202115	30031	100	4,30	37,36



Chalk - Polvo colorante



Polvo colorante para ser usado con la plomada CL-1221 y otros. Disponible en azul, rojo, blanco y amarillo. Las botellas de polvo tienen una escala de resistencia al agua, similar al icono de frecuencia de uso utilizado en jardinería, que muestra visualmente la duración del producto.

Ref.	Código	Color	Contenido gr	€ / u.
1263100	CHALK-BLUE	Azul	227	3,09
1263101	CHALK-RED	Rojo	227	3,09



CL-1221 - Plomada trazadora



Ref.	Código	Medida cordel m	€ / u.
1263200	CL-1221	30	12,17

Cubos y Capazos



Cubo italiano negro de 10 litros con asa metálica, de caucho resistente con una alta capacidad de absorber impactos. El cubo italiano ha sido diseñado y fabricado para ser resistente a golpes y caídas, a altas y bajas temperaturas y con protección UV para garantizar una larga vida útil. Para trabajos exigentes de albañilería, mezclado, transporte de áridos y agua.



Ref.	Código	Descripción	Capacidad L	€ / u.
2400087	BKC10BM	Cubo de caucho italiano 10 litros asa metálica negro	10	9,96
2400088	BKCESPU11BP	Cubo de caucho espuerta 11 litros negro	11	9,73
2400089	BKCESPU37BP	Cubo de caucho espuerta 37 litros y 4 asas negro	37	23,19
2400090	BKCGAVE14BP	Gaveta de caucho 14 litros negra	14	17,20
2400091	BKCGAVE15BP	Gaveta de caucho 15 litros negra	15	17,20
2400092	BKCCARB30BP	Carbonera de caucho 30 litros negra	30	17,50
2400093	BKCIND12BM	Cubo de caucho industrial 12 litros asa metálica negro	12	13,48
2400094	BKCIND13BM	Cubo plano 13 litros con asa metálica negro	13	13,83

Ref.	Código	Descripción	Capacidad L	€ / u.
21017009	BKT26BM	Capazo 26L con Asa Metálica	26	4,98
21017010	BKT26BP	Capazo 26L R Negro	26	4,20
21017011	BKT30BP	Capazo Vendimia 30L Negro	30	5,12
21017012	BKT42RP	Capazo 42L Rojo Basic	42	6,51
21017013	BKT42BP	Capazo 42L Negro	42	5,65
21017014	BKT65BP	Capazo 65L Negro	65	9,77
21017015	BKT42WP	Capazo 42L USO Alimentario Blanco	42	10,54
21017016	BKT42BLP	Capazo 42L USO Alimentario Azul	42	10,54
21017017	BKT65BLP	Capazo 65L USO Alimentario Azul	65	15,24
21017018	BKT65WBP	Capazo 65L USO Alimentario Blanco	65	15,24
21017019	BKW10BM	Caldereta 11 L	11	6,18

Sacabocados



Sacabocados revolver, fácil selección y visión del diámetro.

Ref.	Código	L mm	€ / u.
8004769	97220	200	24,06



Estuches con juegos sacabocados de bocas intercambiables



10 Bocas / Ø 3 a 20. 1 Mango vertical. Dureza en la boca: 52 - 57 HR



Ref.	Código	Contenido	Medidas mm	Nº piezas	€ / u.
1484950	44950	10 bocas / 1 mango	3, 4, 6, 8, 10, 12, 14, 16, 18, 20	11	114,28
1484952	44952	15 bocas / 1 mango	3, 4, 6, 8, 10, 12, 14, 16, 18, 20, 22, 24, 26, 28, 30	16	243,34

54 - Perforador de chapa redondo mecánico



Ref.	Código	P.G.	mm	Tornillo	€ / u.	Ref.	Código	P.G.	mm	Tornillo	€ / u.
1257851	54/13	-	12,7	540008 M8	33,80	1257827	54/41	-	41	540014 M - 14	71,45
1257800	54/14	-	14	540008 M8	33,80	1257828	54/42	-	42	540014 M - 14	77,69
1257801	54/15	54 G 9	15	540008 M8	33,80	1257829	54/43	-	43	540014 M - 14	77,69
1257802	54/16	-	16	540008 M8	33,80	1257830	54/44	-	44	540014 M - 14	77,69
1257803	54/17	-	17	540008 M8	36,82	1257831	54/45	-	45	540014 M - 14	77,69
1257804	54/18	54 G 11	18	540008 M8	36,82	1257832	54/46	-	46	540014 M - 14	73,22
1257805	54/19	-	19	540008 M8	36,82	1257833	54/47	54 G 36	47	540014 M - 14	83,30
1257806	54/20	54 G 13	20	540010 M10	42,12	1257834	54/48	-	48	540014 M - 14	83,30
1257807	54/21	-	21	540010 M10	42,12	1257835	54/49	-	49	540014 M - 14	83,30
1257808	54/22	54 G 16	22	540010 M10	42,12	1257836	54/50	-	50	540014 M - 14	83,30
1257809	54/23	-	23	540010 M10	48,98	1257837	54/51	-	51	540014 M - 14	85,90
1257810	54/24	-	24	540010 M10	48,98	1257838	54/52	-	52	540014 M - 14	85,90
1257811	54/25	-	25	540010 M10	48,98	1257839	54/55	54 G 42	55	540020 M - 20	137,70
1257812	54/26	-	26	540010 M10	48,98	1257840	54/60	54 G 48	60	540020 M - 20	164,74
1257813	54/27	-	27	540010 M10	48,98	1257841	54/63	-	63	540020 M - 20	181,38
1257814	54/28	54 G 21	28	540012 M12	57,10	1257842	54/65	-	65	540020 M - 20	189,70
1257815	54/29	-	29	540012 M12	57,10	1257843	54/70	-	70	540020 M - 20	203,22
1257816	54/30	-	30	540012 M12	57,10	1257844	54/72	-	72	540020 M - 20	206,96
1257817	54/31	-	31	540012 M12	57,10	1257845	54/75	-	75	540020 M - 20	220,48
1257818	54/32	-	32	540012 M12	57,10	1257846	54/80	-	80	540020 M - 20	225,99
1257819	54/33	-	33	540012 M12	63,75	1257847	54/85	-	85	540020 M - 20	234,21
1257820	54/34	-	34	540012 M12	63,75	1257848	54/90	-	90	540020 M - 20	239,20
1257821	54/35	-	35	540012 M12	63,75	1257849	54/95	-	95	540020 M - 20	259,58
1257822	54/36	-	36	540012 M12	63,75	1257850	54/100	-	100	540020 M - 20	279,34
1257823	54/37	54 G 29	37	540012 M12	63,75	1257854	54/105	-	105	540020 M - 20	309,92
1257824	54/38	-	38	540012 M12	63,75	1257852	54/110	-	110	540020 M - 20	324,48
1257825	54/39	-	39	540012 M12	63,75	1257853	54/115	-	115	540020 M - 20	346,32
1257826	54/40	-	40	540014 M - 14	71,45						

Juego perforadores mecánicos



Ref.	Código	Composición	€ / u.
1257900	54J42	Ø 16-20-25-35	186,06
1257901	54J43	Ø 18-22-25-32	182,42
1257902	54J46	Ø 15-20-22-28	172,54
1258000	54G00	9 Perforadores de PG 9 a PG 48	612,66
1258101	54E3	7 Perforadores de 16, 20, 25, 32, 40, 50 y 63 mm	505,44



54H - Perforador de chapa redondo hidráulico



Capacidad de corte: 2 mm en chapa de acero y 1,5 mm en inoxidable.



Ref.	Código	mm	Tornillo	P.G.	€ / u.
1258250	54/13H	12,5	Ø 8	-	29,22
1258251	54/14H	14	Ø 8	-	29,22
1258252	54/15H	15	Ø 8	-	29,22
1258253	54/16H	16	Ø 8	-	29,22
1258254	54/17H	17	Ø 8	-	32,03
1258200	54/18H	18	Ø 12	54 G 11 H	32,03
1258201	54/19H	19	Ø 12	-	32,03
1258202	54/20H	20	Ø 12	54 G 13 H	37,13
1258203	54/21H	21	Ø 12	-	37,02
1258204	54/22H	22	Ø 12	54 G 16 H	37,02
1258205	54/23H	23	Ø 12	-	44,20
1258206	54/24H	24	Ø 12	-	44,20
1258207	54/25H	25	Ø 12	-	44,20
1258208	54/26H	26	Ø 12	-	44,20
1258209	54/27H	27	Ø 12	-	44,20
1258210	54/28H	28	Ø 12	54 G 21 H	47,84
1258211	54/29H	29	Ø 12	-	47,84
1258212	54/30H	30	Ø 12	-	47,84
1258213	54/31H	31	Ø 12	-	47,84
1258214	54/32H	32	Ø 12	-	47,84
1258215	54/33H	33	Ø 12	-	57,93
1258216	54/34H	34	Ø 12	-	57,93
1258217	54/35H	35	Ø 12	-	57,93
1258218	54/36H	36	Ø 12	-	57,93
1258219	54/37H	37	Ø 12	54 G 29 H	57,93
1258220	54/38H	38	Ø 12	-	57,93
1258221	54/39H	39	Ø 12	-	57,93
1258222	54/40H	40	Ø 20	-	66,04

Ref.	Código	mm	Tornillo	P.G.	€ / u.
1258223	54/41H	41	Ø 20	-	67,39
1258224	54/42H	42	Ø 20	-	69,89
1258225	54/43H	43	Ø 20	-	69,89
1258226	54/44H	44	Ø 20	-	69,89
1258227	54/45H	45	Ø 20	-	69,89
1258228	54/46H	46	Ø 20	-	69,89
1258229	54/47H	47	Ø 20	54 G 36 H	77,48
1258230	54/48H	48	Ø 20	-	77,48
1258231	54/49H	49	Ø 20	-	77,48
1258232	54/50H	50	Ø 20	-	77,48
1258233	54/51H	51	Ø 20	-	80,60
1258234	54/52H	52	Ø 20	-	80,60
1258235	54/55H	55	Ø 20	54 G 42 H	127,92
1258236	54/60H	60	Ø 20	54 G 48 H	120,64
1258237	54/63H	63	Ø 20	-	165,36
1258238	54/65H	65	Ø 20	-	172,64
1258239	54/70H	70	Ø 20	-	188,24
1258240	54/72H	72	Ø 20	-	203,84
1258241	54/75H	75	Ø 20	-	215,28
1258242	54/80H	80	Ø 20	-	219,44
1258243	54/85H	85	Ø 20	-	223,08
1258244	54/90H	90	Ø 20	-	227,76
1258245	54/95H	95	Ø 20	-	236,08
1258246	54/100H	100	Ø 20	-	252,72
1258247	54/105H	105	Ø 20	-	269,36
1258248	54/110H	110	Ø 20	-	295,36
1258249	54/115H	115	Ø 20	-	317,20

5400 - Conjunto hidráulico y accesorios



Bomba con manguera y cilindro a elegir de 8Tn o 17 Tn, según necesidades.

Ref.	Código	Tn	€ / u.
1258700	5400CH	8	1.003,60
1258701	5414CH	14	1.211,60



54C Perforador de chapa cuadrado. Mecánico



Capacidad de corte: 2 mm en chapa de acero y 1,5 mm en inoxidable.

54C cuadrado mecánico

Ref.	Código	mm	Tornillo	€/ u.
1258300	54C46	46 x 46	M-20	467,48
1258301	54C67	67 x 67		588,12
1258302	54C92	92 x 92		778,44



54C cuadrado hidráulico

Ref.	Código	mm	Tornillo	€/ u.
1258400	54C46H	46 x 46	20	462,80
1258401	54C67HN	67 x 67		364,00
1258402	54C92H	92 x 92		773,76

54R Perforador de chapa rectangular. Mecánico



Capacidad de corte: 2 mm en chapa de acero y 1,5 mm en inoxidable.

54R rectangulares mecánico

Ref.	Código	Dimensiones mm	€/ u.
1258500	54RE2870	28,5 x 70	453,44
1258501	54R4070	40 x 70	502,32
1258502	54RE4290	42 x 90	619,32
1258503	54RE5280	52 x 80	638,56
1258504	54R35113	35 x 113	671,53



54R rectangulares hidráulico

Ref.	Código	Dimensiones mm	€/ u.
1258601	54R4070H	40 x 70	476,01
1258602	54R4290H	42 x 90	551,93
1258603	54R5280H	52 x 80	626,50
1258604	54R35113H	35 x 113	671,53

4651 - Formón



• Hoja de Acero Cromo-Vanadio reusable en toda su longitud. Perfectamente rectificadas y torneadas. • Tratamiento térmico de precisión en la hoja: máxima duración y resistencia al desgaste. • Sección cuadrada de la espiga para evitar la rotación del mango. • Enmangado mediante prensa neumática para asegurar perfecta unión entre hoja y espiga. • Hojas barnizadas para proteger de la oxidación. • Dos tipos de mangos: - Mangos de madera barnizados, ligeros y de tacto agradable. - Mangos bimateriales ergonómicos con acabado SOFT TOUCH para mayor comodidad durante el trabajo.

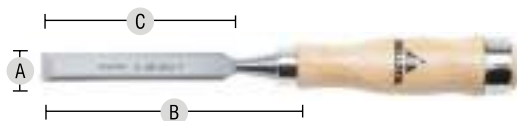

Ref.	Código	A mm	B mm	C mm	€/ u.
1259300	4651-4	4	125	99	14,60
1259301	4651-6	6	125	99	14,71
1259302	4651-8	8	132	102	15,03
1259303	4651-10	10	132	102	15,47
1259304	4651-12	12	132	102	16,07
1259305	4651-14	14	140	108	16,60
1259306	4651-16	16	140	108	16,81
1259307	4651-18	18	150	115	17,34

Ref.	Código	A mm	B mm	C mm	€/ u.
1259308	4651-20	20	150	115	18,07
1259309	4651-22	22	150	115	19,07
1259310	4651-24	24	160	122	20,07
1259311	4651-26	26	160	122	20,96
1259312	4651-28	28	160	122	21,54
1259313	4651-30	30	160	122	22,14
1259314	4651-32	32	160	122	23,62



5001 - Picachón



• Fabricados con Acero Especial Bellota. • Forjados en una sola pieza, irrompibles. • Tratamiento térmico 3+ para alargar la vida útil de la herramienta: no se rompe, no se deforma, no se desgasta. • Pintura epoxi para evitar la oxidación de la herramienta. Usos: • Picachones: para abrir zanjas y picar piedra.

Ref.	Código	A mm	B mm	€ / u.
1259600	5001-A	450	50	29,98
1259601	5001-B	480	52	29,26
1259602	5001-C	520	55	33,80
1259603	5001-D	570	58	39,09

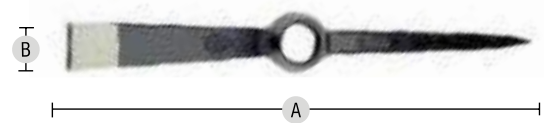
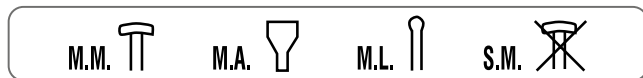

5501 - Pala redonda



• Fabricadas con Acero Especial Bellota. • Tratamiento térmico 3+ para alargar la vida útil de la herramienta: no se rompe, no se deforma, no se desgasta. • Cubo muy resistente, remachado, que asegura una perfecta unión hoja mango. • Mangos de madera de haya barnizados, ligeros y de tacto agradable. Certificados PEFC. Tres posibilidades de mango: muleta [MM], anilla [MA] y largo [ML]. • Pintura epoxi para evitar la oxidación de la herramienta. Usos: • Para cavar y recoger escombros, cemento, tierra, etc.

Ref.	Código	A mm	B mm	€ / u.
1259700	5501-2 MM	1.000	320	23,60
1259701	5501-3 MM	1.015	335	24,36
1259702	5501-4 MM	1.005	345	27,93
1259704	5501-2 MA	1.000	320	26,83
1259705	5501-3 MA	1.015	335	27,59
1259706	5501-4 MA	1.005	345	33,00
1259709	5501-2 ML	1.470	320	31,61

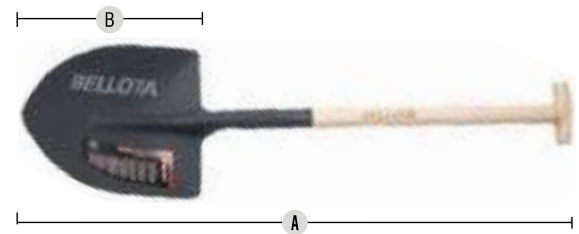
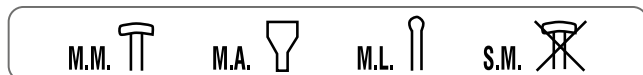

Pala cuadrada



• Fabricadas con Acero Especial Bellota. • Tratamiento térmico 3+ para alargar la vida útil de la herramienta: no se rompe, no se deforma, no se desgasta. • Cubo muy resistente, remachado, que asegura una perfecta unión hoja mango. • Mangos de madera de haya barnizados, ligeros y de tacto agradable. Certificados PEFC. Tres posibilidades de mango: muleta [MM], anilla [MA] y largo [ML]. • Pintura epoxi para evitar la oxidación de la herramienta. Usos: • Para cavar y recoger escombros, cemento, tierra, etc.

Ref.	Código	A mm	B mm	C mm	€ / u.
1495501	5502-2 MA	1.020	320	250	27,90
1495502	5502-2 MM	1.015	320	250	24,61
1495503	5502-2 ML	1.490	320	250	31,61
1495504	5502-3 MA	1.030	335	265	28,71
1495505	5502-3 MM	1.030	335	265	25,01
1495506	5502-4 MA	1.035	340	275	33,00
1495507	5502-4 MM	1.030	340	275	27,93
1495508	5502-6 MA	1.070	370	305	35,36
1495509	5502-6 MM	1.070	370	305	30,19



Azada



01

Azada forjada en una sola pieza, templada integralmente para evitar roturas y deformaciones. Están pulidas y afiladas especialmente por la zona trasera para asegurar una mejor inserción en la tierra. Incorpora el sistema antigiro en el ojo mediante unas hendiduras que bloquean el giro de la cabeza. Combinada con el mango antigiro, la azada ni se gira, ni se afloja y la unión perfecta dura más. El filo es cóncavo, y la pala estrecha.

Ref.	Código	Anchura de la cabeza (en mm)	Forma del filo	€/ u.
2400095	HOE1AP	80	Cóncavo	19,06
2400096	HOE1BP	90	Cóncavo	19,66
2400097	HOE1CP	105	Cóncavo	21,76
2400098	HOE2AP	140	Recto	25,08
2400099	HOE2BP	190	Recto	25,40
2400100	HOE3AP	180	Cóncavo	29,29
2400101	HOE3BP	195	Cóncavo	29,84
2400102	HOE4AP	165	Recto	28,99
2400103	HOE4BP	180	Recto	30,66



Azada



Azada forjada en una sola pieza, templada integralmente para evitar roturas y deformaciones. Están pulidas y afiladas especialmente por la zona trasera para asegurar una mejor inserción en la tierra. Incorpora el sistema antigiro en el ojo mediante unas hendiduras que bloquean el giro de la cabeza. Combinada con el mango antigiro, la azada ni se gira, ni se afloja y la unión perfecta dura más. Azada estrecha. Especial para cavar y hacer zanjas.

Ref.	Código	Anchura de la cabeza (en mm)	Forma del filo	€/ u.
2400105	HOE7AP	50	Cóncavo	19,11
2400106	HOE8AP	80	Cóncavo	21,92
2400104	HOE5P	120	Recto	37,61
2400107	HOE430P	165	Recto	36,75
2400108	HOE43BP	185	Recto	40,39
2400109	HOE58AP	130	Cóncavo	37,01
2400110	HOE69AP	110	Recto	36,36
2400111	HOE69BP	120	Recto	40,10
2400112	HOE80AP	160	Recto	29,05
2400113	HOE80EP	190	Recto	34,06
2400114	HOE80HP	200	Recto	38,12



Azadilla



Azada forjada en una sola pieza, templada integralmente para evitar roturas y deformaciones. Están pulidas y afiladas especialmente por la zona trasera para asegurar una mejor inserción en la tierra. Incorpora el sistema antigiro en el ojo mediante unas hendiduras que bloquean el giro de la cabeza. Combinada con el mango antigiro, la azada ni se gira, ni se afloja y la unión perfecta dura más. Azada con filo recto y martillo en el ojo.

Ref.	Código	Anchura de la cabeza (en mm)	Forma del filo	€/ u.
2400115	HOE83AP	140	Recto	30,96
2400116	HOE228AP	70	Cóncavo	25,02
2400117	HOE228BP	75	Cóncavo	26,43
2400118	HOE232AP	70	Cóncavo	17,14
2400119	HOE232BP	75	Cóncavo	18,56



5604 - Palote



Palote forjado: Fabricadas con Acero Especial Bellota, en una sola pieza, irrompibles. Mangos de madera de haya barnizados, ligeros y de tacto agradable. Certificados PEFC.

Ref.	Código	A mm	B mm	€/ u.
1260250	5604-24 MA	1010	240	70,02
1260251	5604-26 MA	1030	260	72,33



5701 - Raedera



Fabricados con Acero Especial Bellota. Forjados en una sola pieza, irrompibles. Tratamiento térmico 3+ para alargar la vida útil de la herramienta: no se rompe, no se deforma, no se desgasta. Pintura epoxi para evitar la oxidación de la herramienta. Usos: Raederas y Rastrillos: para mover y esparcir masa de cemento, hormigón, arena y piedra.

Ref.	Código	A mm	B mm	€/ u.
1260200	5701-0	260	160	36,12
1260201	5701-B	300	170	43,09
1260202	5709	310	140	48,88



8130 - Hacha



Hacha vizcaína con cabeza forjada PROLINE para limpiar ramas, realizar pequeñas tareas de corte, poda de árboles y pequeños arbustos. Su filo está especialmente diseñado para que penetre bien en la rama.

Ref.	Código	A mm	€/ u.
2400120	8130-300C	300	21,68
2400121	8130-400C	400	23,86
2400122	8130-500C	500	26,19
2400123	8130-600C	600	27,98
2400124	8130-700C	700	30,60
2400125	8130-800C	800	32,61
2400126	8130-1000C	1000	36,81
2400127	8130-1200C	1200	38,97
2400128	8130-1500C	1500	43,87
2400129	8130-2000C	2000	51,61



3480 - Hacha garden line



Cabeza forjada de acero con recubrimiento antiadherente, con muesca que permite sacar fácilmente clavos. Mango inyectado sobre cabeza para una unión perfecta. Mango ligero de fibra de vidrio hueco. Usos: Para corte de leña y madera en general, limpieza de árboles y poda.

Ref.	Código	A mm	B mm	€/ u.
1260395	3480	378	80	63,13



5982 - Desencofrador



Fabricadas con Acero Especial Bellota. Tratamiento térmico 3+ para alargar la vida útil de la herramienta: no se rompe, no se deforma, no se desgasta. Cabezas y uñas forjadas para una mayor resistencia de la herramienta. Diseño especial de las uñas para realizar el mínimo esfuerzo. Pintura al agua para evitar la oxidación de la herramienta. Usos: Desencofradores: para realizar palanca y eliminar el soporte del encofrado.

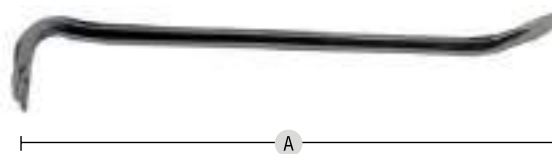

Ref.	Código	A mm	€ / u.
1260400	5982-18x500	500	19,68
1260401	5982-20x600	600	22,53
1260402	5982-20x700	700	25,24

Ref.	Código	A mm	€ / u.
1260403	5982-22x800	800	30,10
1260404	5982-22x1000	1000	37,20
1260405	5982-22x1200	1200	40,44

5985 - Grifa



Fabricadas con Acero Especial Bellota. Tratamiento térmico 3+ para alargar la vida útil de la herramienta: no se rompe, no se deforma, no se desgasta. Cabezas y uñas forjadas para una mayor resistencia de la herramienta. Diseño especial de las uñas para realizar el mínimo esfuerzo. Pintura al agua para evitar la oxidación de la herramienta. Usos: Grifas: para doblar ferralla en el proceso de encofrado.



Ref.	Código	A mm	€ / u.
1260501	5985-8	380	18,17
1260502	5985-10	460	20,06
1260503	5985-12	500	22,88
1260504	5985-14	600	27,64

Ref.	Código	A mm	€ / u.
1260505	5985-16	700	34,72
1260506	5985-18	850	41,40
1260507	5985-20	1000	52,07
1260508	5985-22	1100	67,56

5841 BIM - Paleta forjada



Modelo catalana Para toda la vida. Forjada en una sola pieza, está fabricada en acero especial Bellota. Tratada térmicamente.

Ref.	Código	A mm	C mm	€ / u.
1260600	5841-A	150	115	23,62
1260601	5841-B	165	120	22,88
1260602	5841-C	180	125	23,21

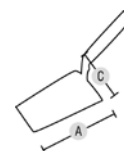

TRF41 - Paleta forjada



Paleta profesional catalana de acero, forjada en una sola pieza, máxima duración y garantía total contra roturas (irrompible). Tratamiento térmico diferenciado en hoja y espiga, no se rompe, no se deforma y no se desgasta. Perfecta fijación mango-espiga. Mango bimaternal con protector del dedo índice (máximo control y ergonomía) y zona trasera de golpeo para asentar las baldosas cerámicas y ladrillos. Para trabajos de albañilería y alicatado.

Ref.	Código	A mm	C mm	€ / u.
2400130	TRF41ABM	150	115	25,17
2400131	TRF41BBM	165	120	25,05
2400132	TRF41CBM	180	125	25,64



5842 - Paleta forjada



Modelo Madrid Para toda la vida. Forjada en una sola pieza, está fabricada en acero especial Bellota. Tratada térmicamente. No baila. Perfecta fijación entre la espiga y el mango. Dos tipos de mango: - Mango de madera de haya de tacto suave y con certificación PEFC. - Mango ergonómico bimaternal de tacto suave.

Ref.	Código	A mm	C mm	€/ u.
1260700	5842-B	115	68	19,00
1260701	5842-D	140	80	19,99
1260702	5842-F	165	92	19,88
1260703	5842-H	190	104	21,17
1260704	5842-J	215	116	22,93
1260705	5842-K	227	122	23,92
1260706	5842-L	240	128	24,20

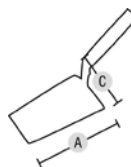

TRF42 - Paleta forjada



Paleta profesional madrileña de acero, forjada en una sola pieza, máxima duración y garantía total contra roturas (irrompible). Tratamiento térmico diferenciado en hoja y espiga, no se rompe, no se deforma y no se desgasta. Perfecta fijación mango-espiga. Mango bimaternal con protector del dedo índice (máximo control y ergonomía) y zona trasera de golpeo para sentar las baldosas cerámicas y ladrillos. Para trabajos de albañilería y alicatado.

Ref.	Código	A mm	C mm	€/ u.
2400133	TRF42HBM	190	104	23,53
2400134	TRF42JBM	215	116	25,17
2400135	TRF42KBM	227	122	25,77
2400136	TRF42LBM	240	128	26,11



5843 - Paleta forjada



Modelo Andaluz Para toda la vida. Forjada en una sola pieza, está fabricada en acero especial Bellota. Tratada térmicamente.

Ref.	Código	A mm	C mm	€/ u.
1260800	5843-A	180	85	25,92
1260801	5843-C	200	90	26,78

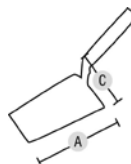

TRF43 - Paleta forjada



Paleta profesional andaluza de acero, forjada en una sola pieza, máxima duración y garantía total contra roturas (irrompible). Tratamiento térmico diferenciado en hoja y espiga, no se rompe, no se deforma y no se desgasta. Perfecta fijación mango-espiga. Mango bimaternal con protector del dedo índice (máximo control y ergonomía) y zona trasera de golpeo para sentar las baldosas cerámicas y ladrillos. Para trabajos de albañilería y alicatado.

Ref.	Código	A mm	C mm	€/ u.
2400137	TRF43ABM	180	110	27,47
2400138	TRF43CBM	200	117	27,57



5844 - Paleta



Modelo Norte Para toda la vida. Forjada en una sola pieza, está fabricada en acero especial Bellota. Tratada térmicamente. No baila. Perfecta fijación entre la espiga y el mango. Dos tipos de mango: Mango de madera de haya de tacto suave y con certificación PEFC. Mango ergonómico bimaterial de tacto suave.

Ref.	Código	A mm	C mm	€ / u.
1260807	5844-C	190	117	26,65
1260808	5844-A BIM	180	115	27,06
1260809	5844-B BIM	180	130	27,06



TRF44 - Paleta forjada



Paleta profesional norte de acero, forjada en una sola pieza, máxima duración y garantía total contra roturas (irrompible). Tratamiento térmico diferenciado en hoja y espiga, no se rompe, no se deforma y no se desgasta. Perfecta fijación mango-espiga. Mango bimaterial con protector del dedo índice (máximo control y ergonomía) y zona trasera de golpeo para sentar las baldosas cerámicas y ladrillos. Para trabajos de albañilería y alicatado.

Ref.	Código	A mm	C mm	€ / u.
2400139	TRF44ABM	180	115	27,06
2400140	TRF44BBM	180	130	27,06



5901 - Paletín



Paletines. Para toda la vida. Forjada en una sola pieza, está fabricada en acero especial Bellota. Tratada térmicamente. No baila. Perfecta fijación entre la espiga y el mango. Dos tipos de mango: - Mango de madera de haya de tacto suave y con certificación PEFC. - Mango ergonómico bimaterial de tacto suave.

Ref.	Código	A mm	C mm	€ / u.
1261120	5901-A	125	70	20,61
1261122	5901-B	150	100	23,54

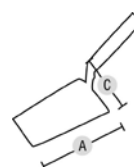

5901-A BIM - Paletín



Paletín profesional triangular de acero, forjado en una sola pieza, máxima duración y garantía total contra roturas (irrompible). Tratamiento térmico diferenciado en hoja y espiga, no se rompe, no se deforma y no se desgasta. Perfecta fijación mango-espiga. Mango bimaterial con protector del dedo índice, máximo control y ergonomía. Para trabajos de acabado y retoques en albañilería.

Ref.	Código	A mm	C mm	€ / u.
2400141	TRF01BM	125	70	20,66



5902 - Paletín



Paletines. Para toda la vida. Forjada en una sola pieza, está fabricada en acero especial Bellota. Tratada térmicamente. No baila. Perfecta fijación entre la espiga y el mango. Dos tipos de mango: - Mango de madera de haya de tacto suave y con certificación PEFC. - Mango ergonómico bimaternal de tacto suave.

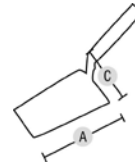

Ref.	Código	A mm	C mm	€ / u.
1261130	5902	135	60	19,99

5902 BIM - Paletín



Paletín profesional hoja de olivo de acero, forjado en una sola pieza, máxima duración y garantía total contra roturas (irrompible). Tratamiento térmico diferenciado en hoja y espiga, no se rompe, no se deforma y no se desgasta. Perfecta fijación mango-espiga. Mango bimaternal con protector del dedo índice, máximo control y ergonomía. Para trabajos de acabado y retoques en albañilería.

Ref.	Código	A mm	C mm	€ / u.
2400142	TRF02BM	135	60	21,73



5903 - Paleta forjada



Paletines. Para toda la vida. Forjada en una sola pieza, está fabricada en acero especial Bellota. Tratada térmicamente. No baila. Perfecta fijación entre la espiga y el mango. Dos tipos de mango: - Mango de madera de haya de tacto suave y con certificación PEFC. - Mango ergonómico bimaternal de tacto suave.

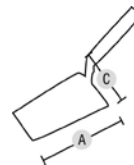

Ref.	Código	A mm	C mm	€ / u.
1261001	5903	125	75	20,61

5903 BIM - Paletín



Paletín profesional punta redonda de acero, forjado en una sola pieza, máxima duración y garantía total contra roturas (irrompible). Tratamiento térmico diferenciado en hoja y espiga, no se rompe, no se deforma y no se desgasta. Perfecta fijación mango-espiga. Mango bimaternal con protector del dedo índice, máximo control y ergonomía. Para trabajos de acabado y retoques en albañilería.

Ref.	Código	A mm	C mm	€ / u.
2400143	TRF03BM	125	75	21,73





5861 - Llana

Fabricadas en Acero Flexible Especial Bellota. Tratamiento térmico 3+ para alargar la vida útil de la herramienta: no se rompe, no se deforma, no se desgasta. Mango muy ergonómico y ligero: hueco de la mano adaptado a usos y necesidades. Válido para diestros y zurdos. Dos tipos de mango: - Mangos de madera de chopo barnizados, extra-ligeros y de tacto agradable. - Mangos bimateriales ergonómicos con acabado SOFT TOUCH para mayor comodidad durante el trabajo. Perfecto enmangado y planitud de la hoja. Hojas barnizadas en epoxi para evitar la oxidación de la herramienta.

Ref.	Código	A mm	B mm	€ / u.
1261200	5861-00	270	135	12,00
1261201	5861-0	300	120	12,00
1261202	5861-1	300	150	12,25
1261203	5861-2	300	160	12,42
1261204	5861-3	300	180	13,06
1261205	5861-00 BIM	270	135	12,53
1261206	5861-0 BIM	300	120	12,53
1261207	5861-1 BIM	300	150	13,06
1261208	5861-2 BIM	300	160	14,00
1261209	5861-3 BIM	300	180	14,19
1261210	5861-1 INOX	300	150	13,27
1261220	5861-1 A INOX	300	150	15,80
1261221	5861-1 A BIM INOX	300	150	17,44
1261222	5869	300	140	9,87

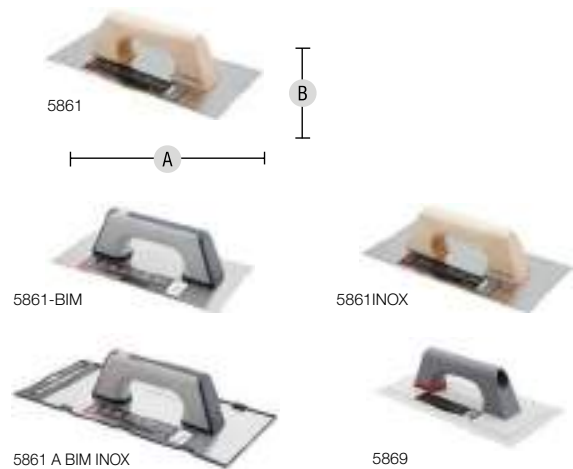

5864 - Llana mango abierto



Fabricadas en Acero Flexible Especial Bellota. Tratamiento térmico 3+ para alargar la vida útil de la herramienta: no se rompe, no se deforma, no se desgasta. Mango muy ergonómico y ligero: hueco de la mano adaptado a usos y necesidades. Válido para diestros y zurdos.

Ref.	Código	A mm	B mm	€ / u.
1280000	5864 BIM	280	120	13,92
1280001	5864 BIM INOX	280	120	14,57

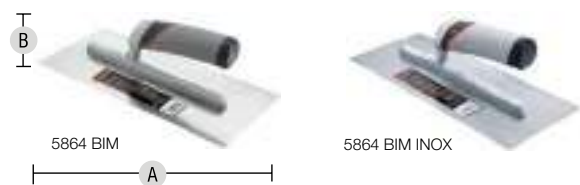

5871-5873 - Peine



Fabricadas en Acero Flexible Especial Bellota. Tratamiento térmico 3+ para alargar la vida útil de la herramienta: no se rompe, no se deforma, no se desgasta. Mango muy ergonómico: hueco de la mano adaptado a usos y necesidades. Dos tipos de mango: - Mangos de madera de chopo barnizados, EXTRA-ligeros y de tacto agradable. Mangos bimateriales ergonómicos con acabado SOFT TOUCH para mayor comodidad durante el trabajo. Perfecto enmangado y planitud de la hoja. Hojas barnizadas en epoxi para evitar la oxidación de la herramienta. Usos: Para preparar superficies para alicatar. Para extender cemento cola y repartirlo uniformemente para colocar el material cerámico.

Ref.	Código	A mm	B mm	€ / u.
1261302	5873-03	270	135	12,79
1261303	5873-06	270	135	12,39
1261304	5873-08	270	135	12,39
1261305	5873-10	270	135	12,39
1261306	5873-12	270	135	12,79
1261307	5873-03 BIM	270	135	13,57
1261308	5873-06 BIM	270	135	13,57
1261309	5873-08 BIM	270	135	13,57
1261310	5873-10 BIM	270	135	13,57
1261311	5873-12 BIM	270	135	13,57

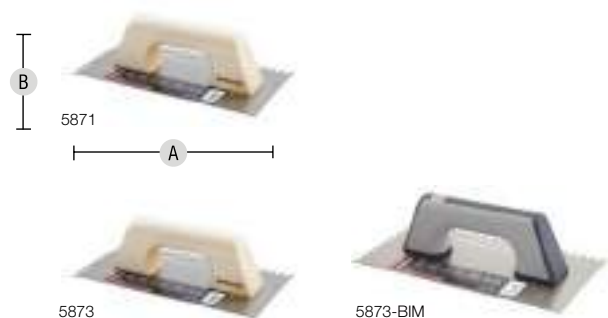

5880-5889 - Talocha



Base de poliestireno de alta calidad: máxima duración sin deterioro. Mango de plástico muy ligero y ergonómico: hueco de la mano adaptado a usos y necesidades. Perfecto enmangado y planitud de la hoja. Usos: Para realizar trabajos de acabado. Para talochar o fratar superficies de cemento, mortero y otros materiales.

Ref.	Código	A mm	B mm	€/ u.
1261500	5881	265	140	8,33
1261600	5885	330	220	10,04
1261602	5883	275	180	8,63
1261603	5888	290	123	9,99
1261606	5880	270	135	14,02
1261620	5887	360	190	10,04
1261621	5882	262	140	6,68
1261622	5884	265	140	7,09
1261623	5889	254	97	11,49

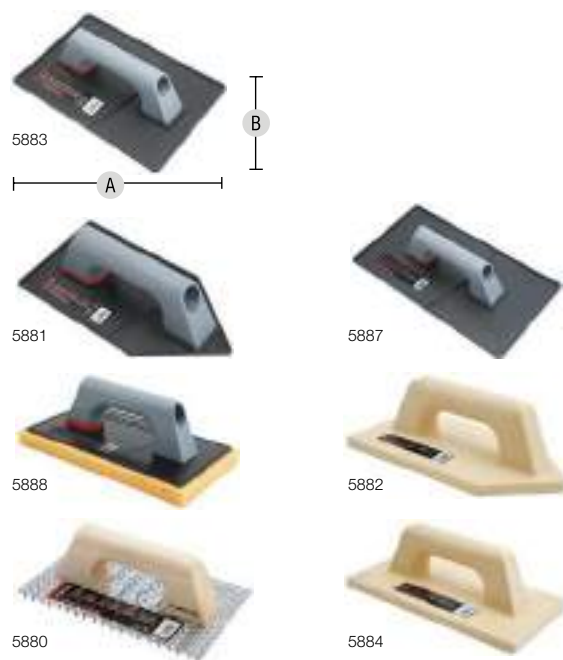

5890 - Espátula



Fabricadas en Acero Especial Bellota: máxima duración sin deterioro. Hojas cónicas rectificadas, alineadas y pulidas para conseguir un acabado perfecto. Excelente flexibilidad y comodidad durante el trabajo, sin holguras. Dos tipos de mango: - Mangos de madera barnizados, ligeros y de tacto agradable. Mangos bimateriales ergonómicos con acabado SOFT TOUCH para mayor comodidad durante el trabajo. Usos: Para realizar trabajos de acabado.

Ref.	Código	A mm	B mm	€/ u.
1261701	5890-30	30	215	4,25
1261702	5890-40	40	210	4,51
1261703	5890-50	50	210	4,76
1261704	5890-60	60	210	4,86
1261705	5890-70	70	220	5,19
1261706	5890-80	80	220	5,36
1261708	5890-100	100	230	6,91

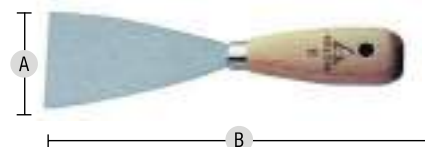

2150 - Espátula bimaterial



Ref.	Código	A mm	B mm	€/ u.
1261801	215000030	30	220	4,52
1261802	215000040	40	220	4,69
1261803	215000050	50	220	4,87
1261804	215000060	60	220	5,00
1261805	215000070	70	220	5,39

Ref.	Código	A mm	B mm	€/ u.
1261806	215000080	80	220	5,70
1261807	215000090	90	220	6,14
1261808	215000100	100	220	6,89
1261809	215000120	120	220	8,45

2161 - Espátula bimaterial, hoja inoxidable

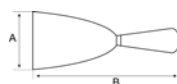

Ref.	Código	A mm	B mm	€ / u.
1261900	216100040	40	220	8,35
1261901	216100060	60	220	9,79
1261902	216100080	80	220	11,00

Ref.	Código	A mm	B mm	€ / u.
1261903	216100100	100	220	11,64
1261904	216100120	120	220	12,58

5893 - Espátula



Fabricadas en Acero INOXIDABLE Especial Bellota: máxima duración sin deterioro. • Hojas cónicas rectificadas, alineadas y pulidas para conseguir un acabado perfecto. • Excelente flexibilidad y comodidad durante el trabajo, sin holguras.

Ref.	Código	A mm	B mm	€ / u.
1262100	5893-40	40	210	4,97
1262101	5893-60	60	210	5,48
1262102	5893-80	80	220	6,07
1262103	5893-100	100	230	7,60

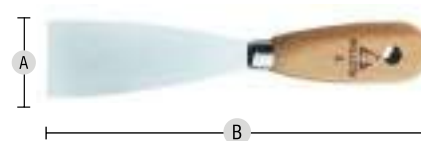

5894 - Espátula inoxidable



ESPÁTULAS PARA PLACA Usos: • Para encintado y acabado de las juntas de placas de yeso laminado. • Para masillado de las cabezas de los tornillos.

Ref.	Código	A mm	B mm	€ / u.
1261715	5894-150 N	150	235	13,92
1261716	5894-150P N	150	257	13,69



5895-5896 - Espátula inoxidable



ESPÁTULAS PARA PLACA Usos: • Para encintado y acabado de las juntas de placas de yeso laminado. • Para masillado de las cabezas de los tornillos.

Ref.	Código	A mm	B mm	€ / u.
1262054	5895-200	200	240	11,16
1262055	5895-250	250	240	12,63
1262056	5895-300	300	240	12,97
1262058	5896-E	275	100	14,86
1262059	5896-R	275	100	14,38
1262060	5896-180	180	475	24,01



5900 - Espátula americana inoxidable



INOX

ESPÁTULAS PARA PLACA Mango bimaternal y hoja inoxidable • Para encintado y acabado de las juntas de placas de yeso laminado. • Para masillado de las cabezas de los tornillos.

Ref.	Código	A mm	B mm	€/ u.
1261720	5900-140	140	256	6,32
1261721	5900-160	160	256	6,63
1261722	5900-180	180	256	6,96
1261723	5900-200	200	256	7,30



2190 - Espátula de emplastecer



Ref.	Código	A mm	B mm	€/ u.
1262200	219001000	100	235	6,58
1262201	219001200	120	235	7,28
1262202	219001400	140	235	8,14
1262203	219001600	160	235	8,86
1262204	219002000	200	235	11,63

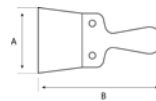

2192 - Espátula de emplastecer inox



Ref.	Código	A mm	B mm	€/ u.
1262300	219201000	100	235	10,66
1262301	219201200	120	235	11,67
1262302	219201400	140	235	14,32
1262303	219201600	160	235	15,88
1262304	219202000	200	235	19,94

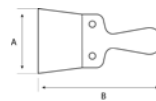

2212 - Espátula de encolar dentado triangular



Ref.	Código	A mm	B mm	€/ u.
1262400	221201200	130	120	5,50
1262401	221202000	130	200	6,71
1262402	221203000	130	300	9,80



2213 - Espátula de encolar, dentado almenado



Ref.	Código	A mm	B mm	€/ u.
1262500	221301200	130	120	5,50
1262501	221302000	130	200	6,53
1262502	221303000	130	300	9,80



51406-18 - Cutter con hoja de titanio



Incluye 6 cuchillas de 18 mm. Duración 8 veces superior al resto de cuchillas.

Ref.	Código	Descripción	€/ u.
1262950	51406-18	Hoja de 18 mm. de acero templado recubierto de titanio. Especial placas de yeso laminado.	16,59



Hoja de recambio para cutter



Hoja para cutter bimaterial Titanium H51406-18

Ref.	Código	Descripción	Contenido	€/ u.
1263003	H51406-18	Tin	10 hojas	6,48



Cutter trabajos ligeros



Cortador trabajos ligeros. Mango Inox con protección ABS.

Ref.	Código	Tipo	Ancho cuchilla mm	Bloqueo	€/ u.
1290010	7224S303	LC-303	9	Automático	5,97



Cutter trabajos duros



Cortador Trabajos duros. Mango Inox con protección ABS y recubrimiento antideslizante.



Ref.	Código	Tipo	Ancho cuchilla mm	Bloqueo	€/ u.
1290020	7224S560	LC-560	18	Automático	8,48
1290021	7224S561	LC-561	18	Manual	8,48
1290030	7224S500	LC-500	18	Automático	8,18
1290031	7224S501	LC-500	18	Manual	8,28

Cuchilla 9 mm



Ref.	Código	Tipo	Ancho cuchilla mm	Contenido unidades	€/ u.
1290060	7224S30	LCB-30	9	10	3,63



Cuchilla 18 mm

Tajima

Ref.	Código	Tipo	Ancho cuchilla mm	Contenido unidades	€ / u.
1290070	7224S50	LCB-50	18	10	5,46
1290072	7224S50C	LCB-50	18	100	45,70

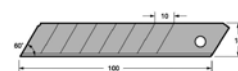

Cuchilla trabajos muy duros 25 mm

Tajima

Cuchilla LCB-65. Trabajos muy duros. Longitud total 126mm. Inclinación hoja 60°. Cuchilla con 7 segmentos de corte de 14mm, grosor 0,7mm.

Ref.	Código	Tipo	Ancho cuchilla mm	Contenido unidades	€ / u.
1290090	7224S65	LCB-65	25	10	15,28

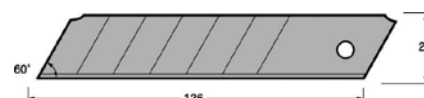

Cutter Komelon Pro

ACHA

• Cutter Profesional con bloqueo automático. • Alta calidad. • Cuchilla segmentada y extra-afilada para corte limpio. • Mango ergonómico bicomponente con elastómero antideslizante. • Gatillo de seguridad. • Guía de acero inoxidable. • Ultra-resistente.

Ref.	Código	Dimensiones mm	Anchura hoja mm	€ / u.
21006007	55340D	185 x 45 x 30	25	12,22
21006008	55352D	156 x 40 x 24	18	7,82



Cutter Komelon Compact Bloqueo rueda

ACHA

• Cutter Profesional con bloqueo de rueda. • Alta calidad. • Cuchilla segmentada y extra-afilada para corte limpio. • Mango ergonómico compacto antideslizante. • Gatillo de seguridad. • Guía de acero inoxidable. • Ultra-resistente.

Ref.	Código	Dimensiones mm	Anchura hoja mm	€ / u.
21006009	55341D	185 x 45 x 32	25	11,20
21006010	55353D	156 x 40 x 24	18	8,24



Cutter Komelon Aluminio



- Cutter Profesional con bloqueo automático. • Alta calidad. • Cuchilla segmentada y extra-afilada para corte limpio. • Mango ergonómico de aluminio fundido. • Gatillo de seguridad. • Guía de acero inoxidable. • Ultra-resistente.

Ref.	Código	Dimensiones mm	Anchura hoja mm	€ / u.
21006011	55354D	156 x 40 x 24	18	12,22



Cutter Komelon Metálico extra-fino



- Cutter Profesional con bloqueo automático. • Alta calidad. • Cuchilla segmentada y extra-afilada para corte limpio. • Cuerpo metálico extra-fino. • Guía de acero inoxidable. • Ultra-resistente.

Ref.	Código	Dimensiones mm	Anchura hoja mm	€ / u.
21006012	55360D	135 x 11 x 8	9	4,03



Cutter Komelon Compact



- Cutter Profesional con bloqueo automático. • Alta calidad. • Cuchilla segmentada y extra-afilada para corte limpio. • Mango ergonómico compacto antideslizante. • Guía de acero inoxidable. • Ultra-resistente.

Ref.	Código	Dimensiones mm	Anchura hoja mm	€ / u.
21006013	55361D	145 x 20 x 12	9	3,80



Estuche 10 hojas Komelon



- Estuche de 10 cuchillas de repuesto de alta calidad. • Segmentadas y partibles en 13 segmentos. • Extra-afiladas para un corte limpio y ultra-resistentes. • Estuche con carcasa resistente y orificio para colgar.

Ref.	Código	Dimensiones mm	Anchura hoja mm	€ / u.
21006014	55369D	110 x 15 x 10	9	2,90
21006015	55359D	130 x 25 x 14	18	4,45
21006016	55349D	163 x 33 x 15	25	9,90





234
Taladros



268
Taladros percutores a batería



299
Atornilladores neumáticos



236
Taladros percutores



269
Atornilladores a batería



301
Taladros neumáticos



237
Martillos



269
Taladros atornilladores a batería



302
Roscadoras neumáticas



241
Miniamoladoras



270
Martillos a batería



303
Lijadoras neumáticas



244
Amoladoras

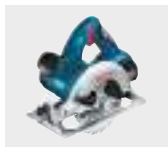

279
Sierras a batería



306
Desbarbadora angular



248
Atornilladores



284
Remachadoras a batería



310
Martillos neumáticos



253
Sierras



285
Remachadoras neumáticas

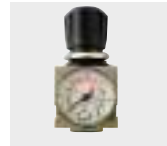

316
Filtros



254
Ingletadoras



287
Hidrolimpiadoras



319
Racores



256
Cepillos



292
Aspiradores



320
Taladros de columna



258
Lijadoras



295
Llaves de impacto neumáticas



328
Fesadoras



263
Fresadoras



298
Carracas neumáticas



330
Mordazas



332
Sierras de cinta



336
Lijadoras



337
Esmeriladoras



340
Tornos



346
Cizallas



353
Construcción



354
Soportes anti-vibratorios



360
Grupos electrógenos

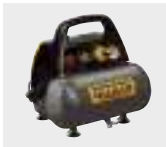

366
Compresores



375
Calefacción

02 | HERRAMIENTA PARA TALLER



Taladro



Ref.	Código	Modelo	Potencia W	N° de velocidades	Ø máx. perforación en acero mm	Ø máx. perforación en madera mm	Velocidad r.p.m.	Peso kg	€/ u.
20015272	0601473600	GBM 10 RE PROFESSIONAL	600	1	10	25	0 - 2.600	1,7	169,00
2400444	06011B2000	GBM 13-2 RE PROFESSIONAL	750	2	13	32	0 - 1.00/3.000	2,4	399,00
20015276	0601120503	GBM 16-2 RE PROFESSIONAL	1.050	2	16	40	0 - 600/1.450	3,7	959,00

Taladro



Ref.	Código	Potencia W	Capacidad máx. acero mm	Capac. máx. madera mm	Capacidad portabrocas mm	r.p.m. en vacío	Peso kg	€/ u.
200110	DA4000LR	710	13	38	2,5 - 13	0 - 400/900	4,0	565,00
210111	DP4011	720	13	40	1,5 - 13	0 - 1.200	2,3	231,00
200112	DP4001	750	13	38	2 - 13	0 - 900	2,3	331,00
200101	DP4002	750	13	38	2 - 13	0 - 600	2,6	331,00
200113	DP4003	750	13	38	2 - 13	0 - 600	2,6	331,00
200102	DS4012	750	13	36	2 - 13	0 - 700	2,7	267,00
210115	DA4031	1.050	13	118	1,0 - 13	300	6,3	733,00

Taladro



Ref.	Código	Modelo	Potencia W	Perforación .máx. acero	Revoluciones min.	Peso Kg	€/ u.
200214	600383000	BE 600/13-2	600	13 / 8	0 - 750 / 0 - 2.500	1,9	482,04
2400445	600741850	BE 650	650	13	0-1.500	1,8	103,00
200222	600580000	BE 75-16	750	16	0 - 660	2,6	464,53
8000012	600573810	BE 850-2	850	13	0 - 1100 / 0 - 3100	2,6	318,27
200207	600806000	BDE 1100	1.100	16 / 10	0 - 640 / 0 - 1.200	4,3	873,44
8000013	600574810	BEV 1300-2	1.300	16	0 - 1100 / 0 - 3100	2,7	407,88
200210	600323000	B 32/3	1.800	32	0 - 170 / 0 - 320 / 0 - 470	7,8	1.702,59



Taladro magnético



Ref.	Código	Modelo	Potencia W	Nº de velocidades	Ø máx. perforación en acero mm	Ø máx. perforación en madera mm	Velocidad r.p.m.	Peso kg	€ / u.
21022000	06011B4020	GBM 50-2 PROFESSIONAL	1.200	2	50	50	0 - 250/510	21,4	1.829,00

Taladro magnético



ECO.32+



ECO.50+/T



ECO.100S/T

Ref.	20010002	20010003	20010004
Código	443712357	443712371	443712449
Modelo	ECO.32+	ECO.50+/T	ECO.100S/T
Alimentación	230-F1	230-F1	230-F1
Potencia	1.050	1.375	2.050
Velocidad	0-400	0-250 / 0 - 460	0-85 / 0-152 / 0-270 / 0-480
Fresa máx. mm	12-32	12-50	12-100
Brocas máx. mm	Ø13	Ø1-23	Ø1-31,75
Avellanado máx. mm	Ø40	hasta Ø55	hasta Ø105
Recorrido max.	150	170	260
Peso kg	11	14	27,8
€ / u.	965,00	1.510,00	1.425,00

Taladro magnético



MAG 32



MAG 50

Ref.	Código	Modelo	Potencia W	Ø máx. de perforación con broca sacanúcleos:	máx. de perforación con broca espiral:	Profundidad máxima de perforación	€ / u.
2400446	600635500	MAG 32	1.000	32	13	50 mm	1.531,61
2400447	600636500	MAG 50	1.200	50	20	50 mm	2.142,40



Taladro percutor



GSB 13 RE PROFESSIONAL



GSB 16 RE PROFESSIONAL



GSB 20-2 PROFESSIONAL



GSB 21-2 RCT Professional



GSB 24-2 + L-CASE PROFESSIONAL



GSB 162-2 RE PROFESSIONAL

Ref.	Código	Modelo	Potencia W	Nº de velocidades	Ø máx. perforación en hormigón mm	Ø máx. perforación en madera mm	Velocidad r.p.m.	Peso kg	€/ u.
200400	0601217100	GSB 13 RE PROFESSIONAL	600	1	13	25	2.800	1,8	102,00
200410	060114E500	GSB 16 RE PROFESSIONAL	750	1	16	30	2.800	2,2	213,00
2400448	060117B400	GSB 20-2 PROFESSIONAL	850	2	20	40	0 - 800 / 2.060	2,6	259,00
8000014	060119C801	GSB 24-2 + L-CASE PROFESSIONAL	1.100	2	22	40	0 - 900 / 3.000	2,9	299,00
2400449	060119C700	GSB 21-2 RCT Professional	1.300	2	24	40	0 - 900 / 3.000	2,9	355,00
8000015	0611332100	GSB 162-2 RE PROFESSIONAL	1.500	2	82	50	0 - 750 / 1.800	4,8	749,00

Taladro percutor



SBE 850-2



SBEV 1000-2



SBEV 1300-2

Ref.	Código	Modelo	Potencia W	Perforación .máx. Mampostería	Revoluciones min.	Peso Kg	€/ u.
8000017	0601824800	SBE 850-2	850	20	0 - 1.100 / 0 - 3.100	2,6	252,35
8000018	06017D0000	SBEV 1000-2	1.010	22	0 - 1.000 / 0 - 2.800	2,7	313,12
8000019	06017D0101	SBEV 1300-2	1.300	24	0 - 1.100 / 0 - 3.100	2,8	396,55

Taladro percutor



06017D0200



06017D0300



06017D0500



06017D0400



06017D0700

Ref.	Código	Potencia W	Capac. máx. madera mm	Capacidad máx. mampostería mm	Nº Percusiones i.p.m.	r.p.m. en vacío	Peso kg	€/ u.
200711	06017D0300	680	36	16	0 - 44.800	0 - 2.800	2,0	131,00
200710	06017D0200	710	30	16	0 - 48.000	0 - 3.200	1,9	141,00
200701	06017D0500	720	40	13	0 - 24.000 / 58.000	0 - 1.200 / 2.900	2,5	208,00
200712	06017D0400	750	40	13	0 - 18.000 / 46.000	0 - 900 / 2.300	2,9	384,00
200713	06017D0700	1.010	40	13	0 - 24.000 / 58.000	0 - 1.200 / 2.900	2,6	278,00



Taladro percutor



06017D1300

06017D1700

06018C1302

06018C1103

Ref.	Código	Potencia W	Revoluciones min.	Percusiones imp	Capacidad acero mm	Capacidad madera mm	Capacidad mampostería mm	AHB	Peso Kg	€ / u.
21049001	06018C1103	550	0-2.900	0-46.400	13	25	16		1,6	95,79
200801	06017D1300	690	0 - 1.000/3.000	27.300/8.400	13	40	18		2	199,82
200802	06017D1700	790	0 - 1.000/3.000	26.000/8.000	13	40	20		2,2	241,02
21049000	06018C1302	1.120	0-1.100/0-3.000	22.000/8.100	16	40	22	si	3	324,45

Martillo



GBH 12-52 DV PROFESSIONAL

GBH 3-28 DFR PROFESSIONAL

GBH 5-40 DCE PROFESSIONAL

GBH 8-45 DV PROFESSIONAL

GBH 2-21 PROFESSIONAL

GBH 2-26 PROFESSIONAL

GBH 2-26 F PROFESSIONAL

GBH 2-28 F PROFESSIONAL

GBH 4-32 DFR PPROFESSIONAL

GBH 12-52 D PROFESSIONAL

GBH 5-40 D PROFESSIONAL

GSH 5 PROFESSIONAL

Ref.	Código	Modelo	Potencia W	Fuerza J	N° impactos máx. i.p.m.	Ø máx. perforación en hormigón mm	Portaherramientas	Peso kg	€ / u.
2400450	06112A6000	GBH 2-21 PROFESSIONAL	720	2	4.800	4 - 21	SDS-plus	2,3	177,00
200932	06112A4000	GBH 3-28 DFR PROFESSIONAL	800	3,1	4.000	4 - 28	SDS-plus	3,6	505,00
20014908	06112A3000	GBH 2-26 PROFESSIONAL	830	2,7	4.000	30	SDS-plus	2,7	259,00
8000021	06018F4200	GBH 2-26 F PROFESSIONAL	830	2,7	4.000	4 - 26	SDS-plus	2,9	315,00
8000022	06018F4300	GBH 2-28 F PROFESSIONAL	880	3,2	4.000	4 - 28	SDS-plus	3,1	399,00
2400451	0611332100	GBH 4-32 DFR PPROFESSIONAL	900	4,2	3.600	6 - 32	SDS-plus	4,7	779,00
21022004	0611338700	GSH 5 PROFESSIONAL	1.100	7,5	2.900		SDS-max	6,175	589,00
20014904	0611269001	GBH 5-40 D PROFESSIONAL	1.100	8,5	2.900	90	SDS-max	6,8	819,00
200933	06018F4000	GBH 5-40 DCE PROFESSIONAL	1.150	8,8	3.050	12 - 40	SDS-plus	6,8	919,00
200934	06018F4100	GBH 8-45 DV PROFESSIONAL	1.500	11	2.760	12 - 45	SDS-plus	8,6	1.269,00
200911	0611266000	GBH 12-52 DV PROFESSIONAL	1.700	19	2.150	12 - 52	SDS-max	11,9	1.569,00

Martillo



UHE 2860-2 Quick

KHE 3251

KH 5-40

KHEV 8-45 BL

Ref.	Código	Modelo	Potencia W	Porta-herramientas	N° Max de golpes	r.p.m. en vacío	diámetro max broca corona mm	EPTA J	Perforación .máx. hormigón mm	Peso Kg	€ / u.
211025	0615990M93	KHE 3251	800	SDS-Plus	4.470	0 - 1150	82	3,1	32	3,9	466,59
8000029	06014A2002	UHE 2860-2 Quick	800	SDS-Plus	4.200	0 - 1.050 / 0 - 2.500	68	2,8	26	3,1	276,04
8000030	0601623000	UHE 2860-2 Quick	1.100	SDS-Plus	4.500	0 - 900 / 0 - 2.100	68	3,4	28	3,3	286,34
8000031	0601B19001	KH 5-40	1.100	SDS-Max	2.800	620	105	8,5	40	7,1	532,51
20043973	060158H000	KHEV 5-40 BL	1.150	SDS-Max	2.900	350 - 500	105	8,7	40	8,3	791,04
20043975	06017D4000	KHEV 8-45 BL	1.500	SDS-Max	2.900	210 - 300	125	12,2	45	10,1	927,00
20043977	0601292801	KHEV 11-52 BL	1.500	SDS-Max	2.360	200 - 270	135	18,8	52	12,4	1.001,16



Martillo



Ref.	Código	Potencia W	Portaherramientas	r.p.m. en vacío	Nº Percusiones i.p.m.	Capacidad máx. hormigón mm	Capacidad máx. acero mm	Capac. máx. madera mm	Capacidad máx. broca corona mm	Peso kg	€/ u.
201250	06019K6104	505	SDS-PLUS	-	0 - 3.200	-	-	-	-	3,4	565,00
201251	0601257001	710	SDS-PLUS	0 - 1.050	0 - 4.050	22	13	32	80	2,6	233,00
221255	060137B201	800	SDS-PLUS	0 - 1.200	0 - 4.600	4 - 26	13	32	35 - 68	2,8	261,00
201209	0601626001	800	SDS-PLUS	0 - 1.200	0 - 4.600	26	13	32	35 - 68	3,0	388,00
201208	06012A6201	800	SDS-PLUS	0 - 1.100	0 - 4.500	28	13	32	80	3,4	408,00
221257	06019H3000	800	SDS-PLUS	0 - 1.100	0 - 4.500	4 - 28	13	32	35 - 80	3,6	516,00
201255	06019B690H	850	SDS-PLUS	315 - 630	1.650 - 3.300	32	13	32	90	4,8	755,00
201210	06019K3302	1.100	SDS-MAX	250 - 500	1.450 - 2.900	10 - 40	-	-	20 - 105	2,7	816,00
201258	06019K6004	1.300	SDS-MAX	-	1.100 - 2.650	-	-	-	-	7,2	753,00
201259	06019H5304	1.350	SDS-MAX	130 - 280	1.250 - 2.750	45	-	-	125	8,2	1.002,00
201261	06019K6205	1.500	SDS-MAX	-	950 - 1.900	-	-	-	-	9,7	861,00
221259	06019J5005	1.500	SDS-MAX	-	950 - 1.900	-	-	-	-	12,3	1.092,00
201262	06019K7001	1.510	Hex. 30mm	-	730 - 1.450	-	-	-	-	15,3	1.098,00
201211	06019K7002	2.000	HEX. 28.6mm	-	8.700	-	-	-	-	31,3	1.920,00

Martillo ligero



Ref.	Código	Potencia W	Brushless	Revoluciones min.	Percusiones ipm	Inserción	AHB	Modos uso	Capacidad hormigon mm	UVP	Peso Kg	€/ u.
21049023	0611923003	730		0-1.050	0-3.950	SDS Plus		3	24		2,8	187,46
21049024	0611921003	730		0-1.050	0-3.950	SDS Plus		2	24		2,8	159,65
21049025	0611917102	830		0-1.100	0-4.300	SDS Plus		3	26		2,8	229,69
21049026	0611913002	830		0-1.100	0-4.300	SDS Plus		2	26		2,8	228,66
21049028	DH28PBY2	850		0-1.100	0-4.300	SDS Plus		2	28	si	2,9	211,15
21049029	DH28PMY2	850		0-1.100	0-4.300	SDS Plus		3	28	si	3	356,38
21049027	DH28PEC	900	si	0-950	0-4.300	SDS Plus	si	3	28	si	2,8	442,90

Martillo cincelador



Ref.	Código	Modelo	Potencia W	Fuerza J	Nº revoluciones máx. r.p.m.	Portaherramientas	Peso kg	€ / u.
8005013	0611320703	GSH 3 PROFESSIONAL	650	2.6	3.500	SDS-plus	3,5	489,00
200907	0611322000	GSH 7 VC PROFESSIONAL	1.500	13	2.720	SDS-max	8,4	1.079,00
200936	0611316703	GSH 11 E PROFESSIONAL	1.500	16.8	900 - 1.890	SDS-max	10,1	935,00
8005015	0611336000	GSH 11 VC PROFESSIONAL	1.700	23	900 - 1.700	SDS-max	11,4	1.239,00
200913	0611335100	GSH 16-30 PROFESSIONAL	1.750	41	1.300	SDS-max	16,5	1.579,00
200937	061130A000	GSH 27 VC PROFESSIONAL	2.000	69	1.000	SDS-max	29,5	2.629,00

Martillo



Ref.	Código	Modelo	Potencia W	Nº Max de golpes	r.p.m. en vacío	Porta-herramientas	EPTA J	Nº máx. golpes min.	Peso Kg	€ / u.
2400453	600147500	MHE 5	1.100	3.000		SDS-Max	7.1	3.000	5.6	450,11
20044012	600769500	MHEV 5 BL	1.150	2.900	2.900	SDS-Max	8.7	2.900	7.9	935,24

Martillo Cincelador



Ref.	Código	Modelo	Potencia W	Nº Max de golpes	r.p.m. en vacío	Porta-herramientas	diámetro max broca corona mm	EPTA J	Perforación .máx. hormigón mm	Peso Kg	€ / u.
2400453	601709500	KHE 2445	800	4.800	0- 1500	SDS-Plus	82	2.4	24	2,8	187,46
2400454	601710500	KHE 2645	850	4.300	0 - 1150	SDS-Plus	82	2.9	26	2,9	203,94



Martillo Cincelador



Ref.	Código	Modelo	Potencia W	N° Max de golpes	Porta-herramientas	EPTA J	Peso Kg	€ / u.
20044010	600770500	MHEV 11 BL	1.500	2.100	SDS-Max	18	12.2	735,42

Martillo picador



Ref.	Código	Potencia W	Brushless	Percusiones ipm	Inserción	AHB	LVH	UVP	Peso Kg	€ / u.
201310	H25PV	500		0-3.200	SDS Plus				3.2	595,34
21049031	H41MB2	950		3.000	SDS Max		si		5.2	568,56
21049030	H41ME	1.050	si	1.500-2.870	SDS Max		si		5	635,51
201312	H45ME	1.150	si	1.430-2.850	SDS Max	si	si		7	779,71
211313	H60MC	1.250		1.600	SDS Max				10.2	698,34
201315	H65SB3	1.340		1.400	Hexagonal 30mm	si		si	18	1.275,14
21049032	H60ME	1.500	si	1.500-2.100	SDS Max	si	si		11.6	933,18

Martillo combinado



Ref.	Código	Modelo	Potencia W	N° Max de golpes	r.p.m. en vacío	Porta-herramientas	diámetro max broca corona mm	EPTA J	Perforación .máx. hormigón mm	Peso Kg	€ / u.
2400455	600391500	KHE 5-40	1.100	3.000	350 - 540	SDS-Max	105	8,5	40	7,1	599,46

Martillo combinado



Ref.	Código	Potencia W	Brushless	Revoluciones min.	Percusiones ipm	Inserción	RFC	Modos uso	LVH	Capacidad hormigon mm	UVP	Peso Kg	€ / u.
21049033	DH28PC	720		0-800	0-4.000	SDS Plus		3		28		3,4	532,51
21049034	DH28PCY2	850		0-1.100	0-4.300	SDS Plus	si	3		28	si	2,9	289,43
21049035	DH40MC	1.100		620	2.800	SDS Max		2		40		6,8	529,42
213720	DH40MEY	1.150	si	250-500	1.430-2.850	SDS Max	si	2	si	40	si	7,5	936,27
21049036	H45MEY	1.150	si		1.430-2.850	SDS Max	si		si		si	7,3	821,94
21049037	DH45ME	1.500	si	120-310	1.200-2.950	SDS Max	si	2	si	45		9	1.009,40
21049038	DH52ME	1.500	si	110-280	1.000-2.400	SDS Max	si	2	si	52	si	11	1.096,95
201320	DH52MEY	1.500	si	110-280	1.000-2.400	SDS Max	si	2	si	52	si	11,5	1.216,43

Miniamoladora



Ref.	Código	Modelo	Potencia W	N° revoluciones máx. r.p.m.	Ø disco mm	Peso kg	€ / u.
201410	0601388106	GWS 7-115 PROFESSIONAL	720	11.000	115	1,8	84,00
8000037	0601394000	GWS 750 PROFESSIONAL	750	11.000	115	1,8	86,00
8000038	0601396008	GWS 880 (115mm) PROFESSIONAL	880	11.000	115	1,9	94,00
8000040	0601396103	GWS 9-115 S PROFESSIONAL	900	2.800 - 11.000	115	1,9	145,00
8000039	060139600A	GWS 880 (125mm) PROFESSIONAL	880	11.000	125	1,9	100,00
8000041	0601396104	GWS 9-125 S PROFESSIONAL	900	2.800 - 11.000	125	1,9	122,00
221412	0601792202	GWS 11-125 P PROFESSIONAL	1.100	11.500	125	2,3	209,00



Miniamoladora



GWS 1000 (125mm)
PROFESSIONAL



GWS 1400 (125mm)
PROFESSIONAL



GWS 14-125
PROFESSIONAL



GWS 14-125 S
PROFESSIONAL



GWS 17-125
PROFESSIONAL



GWS 17-125 S
PROFESSIONAL



GWS 17-125 S INOX
PROFESSIONAL



GWS 17-125 TS
PROFESSIONAL



GWS 17-125 SB
PROFESSIONAL



GWS 17-125 PS
PROFESSIONAL



GWS 17-125 PSB
PROFESSIONAL



GWS 19-125 CI
PROFESSIONAL



GWS 19-150 CI
PROFESSIONAL



GWS 19-125 CIST
PROFESSIONAL



GWX 9-115 S
PROFESSIONAL



GWX 10-125
PROFESSIONAL



GWX 19-125 S
PROFESSIONAL

Ref.	Código	Modelo	Potencia W	N° revoluciones máx. r.p.m.	Ø disco mm	Peso kg	€/ u.
8005498	06017B1000	GWX 9-115 S PROFESSIONAL	900	2.800 - 11.000	115	2,1	177,00
2400456	0601828800	GWS 1000 (125mm) PROFESSIONAL	1.000	11.000	125	2,1	135,00
8005499	06017B3000	GWX 10-125 PROFESSIONAL	1.000	11.000	125	2,2	165,00
2400457	0601824800	GWS 1400 (125mm) PROFESSIONAL	1.400	11.000	125	2,2	177,00
2400458	06017D0000	GWS 14-125 PROFESSIONAL	1.400	11.500	125	2,2	218,00
2400459	06017D0101	GWS 14-125 S PROFESSIONAL	1.400	2.800 - 11.500	125	2,2	265,00
2400460	06017D0200	GWS 17-125 PROFESSIONAL	1.700	11.500	125	2,2	282,00
2400461	06017D0300	GWS 17-125 S PROFESSIONAL	1.700	2.800 - 11.500	125	2,2	295,00
2400462	06017D0500	GWS 17-125 S INOX PROFESSIONAL	1.700	1.900 - 7.800	125	2,2	329,00
2400463	06017D0400	GWS 17-125 TS PROFESSIONAL	1.700	2.400 - 9.700	125	2,2	329,00
2400464	06017D0700	GWS 17-125 SB PROFESSIONAL	1.700	2.800 - 11.500	125	2,2	329,00
2400465	06017D1300	GWS 17-125 PS PROFESSIONAL	1.700	2.800 - 11.500	125	2,2	329,00
2400466	06017D1700	GWS 17-125 PSB PROFESSIONAL	1.700	2.800 - 11.500	125	2,2	339,00
8000046	060179N002	GWS 19-125 CI PROFESSIONAL	1.900	11.500	125	2,4	315,00
8000047	060179R002	GWS 19-150 CI PROFESSIONAL	1.900	9.700	125	2,4	345,00
8000048	060179S002	GWS 19-125 CIST PROFESSIONAL	1.900	7.800	125	2,5	349,00
8005505	06017C8002	GWX 19-125 S PROFESSIONAL	1.900	2.800 - 11.500	125	2,5	359,00

Miniamoladora



Ref.	Código	Potencia W	Ø exterior del disco mm	r.p.m. en vacío	Rosca del husillo	Peso kg	€ / u.
201713	GA4530R	720	115	10.000	M14	1,8	96,00
201702	GA4534	720	115	11.000	M14	1,8	112,00
2400467	9557HNR	840	115	11.000	M14	2,1	114,00
201711	GA5040C	1.400	125	11.000	M14	2,2	231,00
2400468	GA5090X01	1.900	125	2.800-11.500	M14	2,6	276,00
2400469	GA5091X01	1.900	125	2.800-11.500	M14	2,8	316,00
2400470	GA5092X01	1.900	125	11.500	M14	2,6	265,00
2400471	GA5093X01	1.900	125	2.800-11.500	M14	2,9	325,00
2400472	GA5094	1.900	125	11.500	M14	2,9	318,00
2400473	GA5095X01	1.900	125	11.500	M14	2,7	277,00
201712	GA6040C	1.400	150	10.000	M14	2,3	255,00

Miniamoladora



Ref.	Código	Potencia W	Brushless	Revoluciones min.	Ø del disco mm	Peso Kg	€ / u.
21049002	G12STA(S)	600		11.000	115	1,8	62,83
21049004	G12SR4(S)	730		10.000	115	1,8	81,37
21049006	G12SN2	900		10.500	115	2	101,97
21049008	G12SW(S)	1.200		12.000	115	1,8	148,32
21049003	G13STA(S)	600		10.000	125	1,4	72,10
21049005	G13SR4(S)	730		10.000	125	1,8	81,37
21049007	G13SN2	900		10.500	125	2	107,12
21049009	G13SW(S)	1.200		12.000	125	1,8	154,50
21049010	G13BYEQ2WDZ	1.320	si	10.000	125	2,2	346,00
21049011	G13VE2WQZ	1.320	si	2.800-10.000	125	1,8	331,00
21049012	G13SB4	1.400		11.500	125	2,3	190,55



Amoladora



Ref.	Código	Modelo	Potencia W	Ø disco mm	Interruptor Hombre Muerto	Freno	Autobalance	Revoluciones min.	Peso Kg	€ / u.
20041264	603604000	W 750-115	750	115				11.500	1,8	72,10
20041211	603607000	W 850-115	850	115				11.500	1,8	92,70
202069	600371000	W 9-115 Quick	900	115				10.500	2,5	164,80
20041224	603605000	W 750-125	750	125				11.500	1,8	72,10
20041231	603608000	W 850-125	850	125				11.500	1,8	92,70
20041221	603610000	WP 850-125	850	125	si			11.500	1,8	113,30
202070	600374000	W 9-125 Quick	900	125				10.500	2,5	164,80
202060	613060000	WEF 9-125 Quick	910	125				10.000	2,1	442,90
20041253	603621000	WP 11-125 Quick	1.100	125	si			11.000	2,3	208,06
20041249	603625000	WEV 11-125 Quick	1.100	125				2.800 - 10.500	2,1	221,45
20041214	603627000	W 13-125 Quick	1.350	125				11.000	2,4	236,90
202077	600448000	WE 15-125 Quick	1.550	125				11.000	2,5	272,95
202080	600496000	WEVA 15-125 Quick	1.550	125			si	2.800 - 11.000	2,5	303,85
2400474	613114000	WEPBA 19-125 Q DS M-Brush	1.900	125	si	si	si	11.000	2,7	346,08
20041255	603632000	W 13-150 Quick	1.350	150				10.000	2,5	236,90
20041233	601074000	WE 17-150 Quick	1.700	150				9.600	2,6	288,40
20041266	600473000	WEV 17-150 Quick	1.700	150				2.800 - 10.000	2,5	333,72

Amoladora



Ref.	Código	Modelo	Potencia W	Ø disco mm	Velocidad de giro en vacío r.p.m.	Peso kg	€/ u.
2400481	06018C2300	GWS 24-180 JZ PROFESSIONAL	2.400	180	8.500	6	235,00
21022002	0601892F00	GWS 24-180 LVI PROFESSIONAL	2.400	180	8.500	5,4	329,00
2400485	06018G0000	GWS 30 - 180 B PROFESSIONAL	2.800	180	8.500	5,7	429,00
2400487	06018G0100	GWS 30 - 180 PB PROFESSIONAL	2.800	180	8.500	5,7	429,00
2400475	06018C1302	GWS 20-230 J PROFESSIONAL	2.000	230	6.500	5,5	169,00
2400476	06018C1103	GWS 20-230 P PROFESSIONAL	2.000	230	6.500	5,5	169,00
2400477	06018F2000	GWS 2000 J PROFESSIONAL	2.000	230	6.500	5,1	165,00
2400478	06018F2100	GWS 2000 P PROFESSIONAL	2.000	230	6.500	5	169,00
2400480	06018F4100	GWS 2200 P PROFESSIONAL	2.200	230	6.500	5,3	205,00
2400482	06018C3300	GWS 24-230 JZ PROFESSIONAL	2.400	230	6.500	5,8	235,00
2400483	06018F4200	GWS 2400 J PROFESSIONAL	2.400	230	6.500	5,4	235,00
8000057	0601893F00	GWS 24-230 LVI PROFESSIONAL	2.400	230	6.500	5,5	329,00
2400486	06018G1000	GWS 30 - 230 B PROFESSIONAL	2.800	230	6.500	5,9	429,00
2400488	06018G1100	GWS 30 - 230 PB PROFESSIONAL	2.800	230	6.500	5,9	429,00

Amoladora



Ref.	Código	Modelo	Potencia W	Ø disco mm	Interruptor Hombre Muerto	Freno	Autobalance	Revoluciones min.	Peso Kg	€/ u.
202324	606468000	WE 24-180 MVT	2.400	180				8.500	5,8	361,53
8000059	606480000	WEPBA 24-180 MVT Quick	2.400	180	si	si	si	8.500	6	403,76
20041272	606431000	WP 2000-230	2.000	230	si			6.600	5,2	139,05
20041282	606436000	WP 2200-230	2.200	230	si			6.600	5,2	145,23
202322	606464000	WE 22-230 MVT	2.200	230				6.600	5,8	296,64
20041284	606484000	WE 2400-230	2.400	230				6.600	6	206,00
202323	606467260	W 24-230 MVT	2.400	230	si			6.600	5,8	341,96
202325	606469000	WE 24-230 MVT	2.400	230				6.600	5,8	361,53
8000060	606481000	WEPBA 24-230 MVT Quick	2.400	230	si	si	si	6.600	6,2	403,76
8000061	606482000	WEPBA 26-230 MVT Quick	2.600	230	si	si	si	6.600	6,6	535,60



Amoladora



Ref.	Código	Potencia W	Ø exterior del disco mm	r.p.m. en vacío	Rosca del husillo	Peso kg	€/ u.
202250	GA7050R	2.000	180	8.500	M14	4,6	184,00
202252	GA9030R	2.000	180	8.500	M14	4,6	239,00
202254	GA7020R	2.200	180	8.500	M14	6,3	188,00
202255	GA7030R	2.400	180	8.500	M14	6,3	218,00
202256	GA7040R	2.600	180	8.500	M14	6,4	249,00
202251	GA9050R	2.000	230	6.600	M14	4,8	178,00
202259	GA9012C	2.000	230	6.000	M14	4,5	282,00
202253	GA9020R	2.200	230	6.600	M14	6,3	194,00
202257	GA9040R	2.600	230	6.600	M14	6,9	253,00

Amoladora



Ref.	Código	Potencia W	Capacidad de la pinza Ø mm	Brushless	Revoluciones min.	Ø del disco mm	Peso Kg	€/ u.
21049013	G23STWEZ	2.000	6		6.600	230	5.1	122,57
202307	G23SW2W7	2.200	6		6.600	230	5.1	127,72
21049014	G23SWU2	2.200	6		6.600	230	5.3	163,77
21049015	G23BYE	2.200	8	si	6.600	230	4.2	497,49
21049016	G23SC4	2.400	3 - 6 - 8		6.600	230	6.1	209,09
21049017	G23SCY2	2.400	6 - 8		6.600	230	6.3	177,16

Amoladora recta



Ref.	Código	Modelo	Potencia W	N° revoluciones máx. r.p.m.	Portaherramientas	Peso kg	€ / u.
8000064	0601225000	GGs 28 LP PROFESSIONAL	500	30.000	Pinzas de sujeción hasta 8 mm Ø	1,7	409,00
202610	0601221100	GGs 28 LCE PROFESSIONAL	650	10.000 - 28.000	Pinzas de sujeción hasta 8 mm Ø	1,6	409,00
202611	0601221000	GGs 28 LC PROFESSIONAL	650	28.000	Pinzas de sujeción hasta 8 mm Ø	1,6	399,00
8000062	0601220000	GGs 28 C PROFESSIONAL	600	30.000	Pinzas de sujeción hasta 8 mm Ø	1,4	289,00
8000063	0601220100	GGs 28 CE PROFESSIONAL	650	30.000	Pinzas de sujeción hasta 8 mm Ø	1,4	315,00
8000067	0601222100	GGs 8 CE PROFESSIONAL	750	8.000	Pinzas de sujeción hasta 8 mm Ø	1,7	479,00
20014692	0601209200	GGs 18 H PROFESSIONAL	1.050	18.000	Pinzas de sujeción hasta 10 mm Ø	3	919,00
20014693	0601214300	GGs 8 SH PROFESSIONAL	1.200	8.000	Husillo M 14 (Ø 20 mm)	4,4	919,00

Amoladora recta



Ref.	Código	Modelo	Potencia W	Ø orificio pinza mm	Revoluciones min.	Peso Kg	€ / u.
	600427000	G 400	400	6	25.000	1.5	134,93

Amoladora recta



GE 710 Compact



GEP 710 Plus



GEP 950 G Plus

Ref.	Código	Modelo	Potencia W	Ø Orificio pinza mm	Interruptor Hombre Muerto	Revoluciones min.	Peso Kg	€ / u.
202655	600615000	GE 710 Compact	710	6		13.000 - 34.000	1,4	253,38
202656	600616000	GE 710 Plus	710	6		10.000 - 30.500	2,5	306,94
8000069	600617000	GEP 710 Plus	710	6	si	10.000 - 30.500	1,6	337,84
202657	600618000	GE 950 G Plus	950	6		2.500 - 8.700	1,7	363,59
8000070	600627000	GEP 950 G Plus	950	6	si	2.500 - 8.700	1,7	393,46



Amoladora recta



Ref.	Código	Potencia W	Capacidad de la pinza Ø mm	r.p.m. en vacío	Peso kg	€/ u.
202510	GD0600	400	6	25.000	1,7	116,00
202511	GD0601	400	6	25.000	1,7	116,00
202512	GD0602	400	6	25.000	1,4	116,00
202500	GD0800C	750	8	7.000 - 28.000	1,7	359,00
202513	GD0801C	750	3 - 6 - 8	7.000 - 29.000	2,0	424,00
202501	GD0810C	750	6 - 8	1.800 - 7.000	1,7	367,00
202514	GD0811C	750	3 - 6 - 8	1.800 - 7.000	2,0	424,00

Amoladora recta



Ref.	Código	Potencia W	Revoluciones min.	Capacidad pinza mm	Peso Kg	€/ u.
21049018	GP3V	760	7.000 - 29.000	6	1,8	344,02
21049019	GP5V	760	2.000 - 8.300	6	1,9	363,59

Atornillador



GTB 6-50 PROFESSIONAL

Ref.	Código	Modelo	Potencia W	Par de giro máx. (en atornillado blando)	Portaherramientas	Velocidad de giro en vacío	Peso kg	€/ u.
2400490	06014A2002	GTB 6-50 PROFESSIONAL	650	12	Hexágono interior de 1/4"	0 - 5.500	1,4	195,00

Atornillador



Ref.	Código	Potencia W	r.p.m. en vacío	drywall	Dimensiones L x A x h	Peso kg	€ / u.
203260	FS2300	570	0 - 2.500	5	290 x 70 x 207	1,5	196,00
203261	FS2500	570	0 - 2.500	5	280 x 70 x 192	1,5	184,00
203262	FS2700	570	0 - 2.500	5	301 x 70 x 192	1,8	200,00
203263	FS4200	570	0 - 4.000	5	269 x 65 x 192	1,4	167,00
203264	FS6300R	570	0 - 6.000	4	269 x 65 x 207	1,4	198,00

Atornillador de impacto



Ref.	Código	Potencia W	Inserción	N° Percusiones i.p.m.	Par máx. apriete Nm	Capacidad máx. tornillo métrica	r.p.m. en vacío	Peso kg	€ / u.
203410	TW0200	380	12,7 mm [1/2"]	2.200	200	M10 - M16	0 - 2.200	2,1	367,00
203411	TW0350	400	12,7 mm [1/2"]	2.000	350	M12 - M22	0-2.000	3,0	439,00
203401	6905H	470	6,35 mm [1/4"]	2.600	300	M12 - M20	0 - 2.200	2,3	355,00
203402	6906	620	19 mm [3/4"]	1.600	600	M16 - M22	1.700	5,6	763,00
203403	TW1000	1.200	25,4 mm [1"]	1.500	1.000	M24 - M30	1.400	8,4	1.012,00

Atornillador de impacto



Ref.	Código	Potencia W	Brushless	Revoluciones min.	Par máx. apriete Nm	Peso kg	Inserción	AHB	Peso Kg	€ / u.
21049020	WR14VE	370	si	0-2.100	250	1,6	1/2"		2	417,15
21049021	WR16SE	370	si	0-1.600	360	3,4	1/2"		2,5	524,27
213730	WR22SE	800	si	1.400	610	1,4	3/4"	si	4,6	762,20
21049022	WR25SE	900	si	1.100	1.000	1,500	1"	si	7,7	1.129,91



Atornillador de pladur



Ref.	Código	Potencia W	Revoluciones min.	Inserción	Peso Kg	€/ u.
203202	W6VMWA	620	0-6.000	1/4"	1.4	212,18

Biseladora de metal



Ref.	Código	Modelo	Potencia W	N° de revoluciones en vacío r.p.m.	Tipo de bordes	max ancho bisel 45°	max altura de bisel 45°	Ø mínimo de tubería	Peso kg	€/ u.
8001415	601751700	KFM 9-3 RF	900	4500 - 11500	Bisel y radio	6 mm	4 mm	13 mm	2,5	1.108,28
8001416	601752500	KFM 15-10 F	1.550	12.200	Bisel	14 mm	10 mm	75 mm	4,9	2.636,80
8001417	601755500	KFMPB 15-10 F	1.550	12.200	Bisel	14 mm	10 mm	75 mm	5,1	2.727,44
8001418	601753500	KFM 16-15 F	1.600	12.000	Bisel	21 mm	15 mm	100 mm	6,9	3.190,94

Biseladora



Potente motor de alta eficiencia. Indicador claro para ajustar el ángulo, hasta 60°. Adecuado tanto para material de chapa como tubo de hasta 300 mm. Velocidad variable, incluyendo indicador de tipo de material (solo B60S). Asas anchas y suaves. Protección de sobrecarga



Ref.	Código	Modelo	Potencia HP	Velocidad r.p.m.	Prof. Bisel	Angulo biselado	Dimensiones	Peso kg	€/ u.
2100403	446040474	B60	1.4	2.850	24 [a 45°]	0 - 60	415x375x268	24.1	1.715,00
2100404	446044120	B60S	2.4	1675 - 2850	24 [a 45°]	0 - 60	415x375x268	24.1	1.995,00

Fresadora frontal de metal



Ref.	Código	Modelo	Potencia W	Altura de fresado	Nº de revoluciones en vacío r.p.m.	Peso kg	€ / u.
2400491	601789500	PFM 17	1.700	-1.5	8.000 - 12.600	4.6	3.225,96

Máquina para canteado EDGE FINISH



El sistema para canteado EDGE FINISH incluye además de máquina especial para canteado, unas herramientas de corte para biselar, achaflanar y redondear los cantos de piezas de acero de mediano y gran tamaño. Utilizando las plaquitas de metal duro y las fijaciones especiales se pueden conseguir formas de canto exactas: como bisel de 30° ó 45° y radio de 3,0 mm. Además se puede ajustar la altura del bisel entre 1 y 6 mm. Estas plaquitas especiales tienen un revestimiento de gran calidad y con ellas se logran los mejores resultados en el arranque de virutas.



Ref.	Código	Potencia W	r.p.m.	Rosca del husillo	Peso kg	€ / u.
200010	UWER 18/110 EF 230 V	1.750	2.750-11.000	M14	3.64	1.287,20

Cizalla



JS1601



JS1602



JS3201J

Ref.	Código	Potencia W	Capacidad máx. acero inox mm	Capacidad máx. aluminio mm	Carreras por minuto c.p.m.	Capacidad máx. acero dulce mm	Peso kg	Radio mín. de corte interior mm	€ / u.
203950	JS1601	380	1,2	2,5	4.500	1,6	1,4	250	459,00
203952	JS1602	380	0,8	2,5	4.000	1,2	1,6	30	678,00
203953	JS3201J	710	1,5	4	1.600	2,5	3,4	50	537,00



Maletín TK

Bordes definidos en un sólo paso. Para guardar la máquina y las herramientas se suministra en un práctico maletín de plástico que incluye: UWER 18/110 EF con 4 m de cable de red y mango antivibración. Fijación de plaquitas con rodamiento guía. Juego de tornillos para las plaquitas. Llaves de fijación. Las plaquitas no están incluidas en el maletín. Pedir por separado



Ref.	Código	Descripción	Incluye fijación plaquitas	Fijación adecuada para plaquita	€/ u.
200001	UWER 18/110 EF-R3/45 TK 230 V	Maletín sin plaquitas	EF-WSP-A R3/45°	EF-WSP-A R3/45°, EF-WSP-A 30°	2.114,39
200002	UWER 18/110 EF-30 TK 230 V	Maletín sin plaquitas	EF-WSP-A 30°	EF-WSP-A R3/45°, EF-WSP-A 30°	2.114,39

Ref.	Código	Descripción	€/ u.
200005	EF-WSP-R3	Juego de 3 plaquitas para radio de 3 mm	144,91
200006	EF-WSP-F	Juego de 3 plaquitas para canto biselado 30°/45°	154,37

Punzonadora



Ref.	Código	Potencia W	Nº revoluciones máx. r.p.m.	Peso kg	€/ u.
204200	JN1601	550	2.200	1,6	459,00
204202	JN3201J	710	1.300	3,4	678,00



Agitador



Ref.	Código	Modelo	Potencia W	Par de giro máx.	Velocidad de giro en vacío, 1ª velocidad, hasta	Velocidad de giro en vacío, 2ª velocidad	Velocidad de giro en vacío	Peso kg	€/ u.
8004515	06011A8000	GRW 18-2 E	1.800	47	450	1.050	0 - 450 / 1.050	7	725,00

Punzonadora



Ref.	Código	Modelo	Potencia W	Potencia útil W	Acero hasta 400 N/mm2	Marcha en vacío r.p.m.	Peso kg	€/ u.
204001	601530103	GNA 2,0	500	270	2	2.400	2,0	862,00
204003	601533103	GNA 3,5	620	340	3,5	1.000	3,5	1.169,00

Sierra circular



GKS 165 PROFESSIONAL



GKS 190 PROFESSIONAL



GKS 65 GCE PROFESSIONAL



GKS 65 GCE PROFESSIONAL



GKS 85 PROFESSIONAL



GKT 55 CGE PROFESSIONAL

Ref.	Código	Modelo	Potencia W	Profundidad de corte 45°/90° mm	Disco mm	Peso kg	€/ u.
204410	0601676100	GKS 165 PROFESSIONAL	1.050	47/66	165	3,6	227,00
2400492	0601623000	GKS 190 PROFESSIONAL	1.400	50/70	190	4,2	242,00
8000073	0601675000	GKT 55 CGE PROFESSIONAL	1.400	42/57	165	4,7	712,00
204412	0601668900	GKS 65 GCE PROFESSIONAL	1.900	48/65	190	5,2	409,00
2400493	0615990M93	GKS 65 GCE PROFESSIONAL	1.900	48/65	190	5,2	509,00
204413	060157A000	GKS 85 PROFESSIONAL	2.200	65/85	235	7,5	439,00

Sierra circular



HS6100



HS7601



5903RK



5008MG



SP6000J

Ref.	Código	Potencia W	Capacidad máx. mm 90°	Ø exterior del disco mm	Ø interior del disco mm	Capacidad máx. 45° mm_1	Peso kg	r.p.m. en vacío	€/ u.
204554	HS6100	1.100	54,5	165	20	39,5	3,7	5.500	296,00
204555	HS7601	1.200	66	190	30	2,5	4,0	5.200	222,00
204552	5903RK	1.200	85	235	30	64	7,2	4.500	461,00
204556	SP6000J	1.300	56	165	20	40	4,4	2.000 - 5.800	553,00
204553	5008MG	5.200	75,5	210	-	57	5,1	5.200	318,00

Sierra circular



KS 55 FS



KS 85 FS

Ref.	Código	Modelo	Potencia W	Ø hoja mm	Profundidad corte 90°/45° mm	Peso Kg	€/ u.
204498	600955000	KS 55 FS	1.200	160 x 20	55/39	4	187,46
21080002	601066000	KS 66 FS	1.500	190 x 30	66/47	4,9	249,26
21080003	601085000	KS 85 FS	2.000	235 x 30	85/65	8,4	354,00





Ingletadora



KS 216 M Lasercut



KGS 254 M



KGS 305 M



KGT 305 M

Ref.	Código	Modelo	Potencia W	Profundidad max de corte 90°/45°	Ø hoja de sierra mm	Peso Kg	€/ u.
2400494	610216000	KS 216 M Lasercut	1.350	60 / 45	216 x 30	9,4	175,00
8000147	619004000	KGT 305 M	1.600	102 / 70	305 x 30	22	793,10
2400495	613254000	KGS 254 M	1.800	92 / 47	254 x 30	16,1	436,00
2400496	613305000	KGS 305 M	2.000	110 / 67	305 x 30	18,6	525,00

Ingletadora



GTM 12 JL



GCM 80 SJ PROFESSIONAL



GCM 8 SJL



GCM 12 GDL

Ref.	Código	Modelo	Potencia W	Capacidad de corte a 0°, altura	Capacidad de corte a 0°, anchura	Capacidad de corte a 0°	Capacidad de corte a 45° de inglete, altura	Capacidad de corte a 45° de inglete, anchura	Peso kg	€/ u.
8004511	0601B15001	GTM 12 JL	1.800	95	150	95 x 150	95	90	20,75	899,00
2400497	0601B19001	GCM 80 SJ PROFESSIONAL	1.400	45	270	45 x 270	70	190	14,1	419,00
8004512	0601B19100	GCM 8 SJL	1.600	70	312	70 x 312	70	214	17,3	685,00
8004513	0601B23600	GCM 12 GDL	2.000	104	341	104 x 341	104	240	32,1	1.499,00

Ingletadora



LS0815FLN



LS1019L



LS1219L



LH1040F

Ref.	Código	Potencia W	Capacidad máx. 90° mm	Ø exterior del disco mm	Ø interior del disco mm	Capacidad máx. 45° mm	r.p.m. en vacío	Peso kg	€/ u.
205957	LS0815FLN	1.400	69 x 305	216	30	50 x 305	5.000	14,2	765,00
205958	LS1019L	1.430	91 x 310	260	30	50 x 310	4.300	19,9	1.212,00
205955	LS1219L	1.650	102 x 363	305	30	102 x 255	3.200	26,7	1.410,00
205952	LH1040F	1.650	93 x 95	260	30	49 x 67	4.600	11,6	786,00

Sierra de calar



Ref.	Código	Modelo	Potencia W	Nº carreras por minuto c.p.m.	Profundidad corte mm	Peso kg	€/ u.
204710	060158F000	GST 90 BE PROFESSIONAL	650	500 - 3.100	90	2,6	205,00
2400498	060158H000	GST 8000 E PROFESSIONAL	710	800 - 3.100	80	2,5	149,00
204711	0601513000	GST 150 BCE PROFESSIONAL	780	500 - 3.100	150	2,7	299,00
20015202	0601518000	GST 160 BCE PROFESSIONAL	800	800 - 3000	160	2,3	409,00

Sierra de calar



Ref.	Código	Modelo	Potencia W	Nº carreras por minuto c.p.m.	Niveles carrera pendular	Profundidad máx. corte madera mm	Peso Kg	€/ u.
204815	601030500	STEB 65 Quick	450	600 - 3.000	4	65	1,9	96,82
2400499	601110500	STEB 100 Quick	710	1000 - 3100	4	100	2,1	212,18
204813	601402000	STEB 140	750	1.000 - 3.100	4	140	2,5	312,09
204814	601404500	STEB 140 Plus	750	1.000 - 3.100	4	140	2,6	379,04

Sierra de calar



Ref.	Código	Potencia W	Capac. máx. madera mm	Carreras por minuto c.p.m.	Longitud de carrera mm	Capacidad máx. acero mm	Peso kg	€/ u.
204910	4329K	450	65	500 - 3.100	18	6	1,9	133,00
204912	JV0600K	650	90	500 - 3.100	23	10	2,4	200,00
204901	4350CT	720	135	800 - 2.800	26	10	2,6	278,00
204913	4351FCT	720	135	800 - 2.800	26	10	2,5	290,00



Sierra de sable

BOSCH

GST 12 V-70 PROFESSIONAL

GST 18V-LI B

Ref.	Código	Modelo	Potencia W	N° carreras por minuto c.p.m.	Sierra longitud de la carrera mm	Peso kg	€/ u.
205210	060164C800	GST 12 V-70 PROFESSIONAL	1.100	0 - 2.700	28	3,6	245,00
8000074	060164E200	GST 18V-LI B	1.300	0 - 2.900	28	4,1	359,00

Sierra de sable

metabo

SSE 1100

SSEP 1400 MVT

Ref.	Código	Modelo	Potencia W	Longitud carrera mm	N° Carreras por minuto	Peso Kg	€/ u.
205215	606177500	SSE 1100	1.100	28	0 - 2.600	3,5	321,36
205216	606178500	SSEP 1400 MVT	1.400	32	0 - 2.800	4,6	469,68

Sierra de sable

Makita

Ref.	Código	Potencia W	Capacidad máx. tubo mm	Carreras por minuto	Longitud de carrera mm	Capac. máx. madera mm	Potencia W	Peso kg	€/ u.
2400500	JR3061T	1.250	130	0 - 2.800	32	255	1.250	4,2	312,00

Cepillo

BOSCH

GHO 16-82 PROFESSIONAL

GHO 40-82 C PROFESSIONAL

GHO 26-82 D PROFESSIONAL

Ref.	Código	Modelo	Potencia W	N° revoluciones máx. r.p.m.	Profundidad rebaje ajustable mm	Anchura de cepillado mm	Peso kg	€/ u.
206111	06015A4000	GHO 16-82 PROFESSIONAL	630	18.000	0 a 1,6	82	2,8	229,00
20014821	06015A4301	GHO 26-82 D PROFESSIONAL	710	18.000	0 a 2,6	82	3,2	272,00
8000076	060159A760	GHO 40-82 C PROFESSIONAL	850	14.000	0 a 4	82	3,2	459,00

Cepillo



Ref.	Código	Modelo	Potencia W	Profundidad rebaje ajustable mm	Revoluciones min.	Peso Kg	€ / u.
8000079	602682000	HO 26-82	620	0 - 2,3	17.000	2,5	208,06



Cepillo



KP0800



KP0810C



KP312S

Ref.	Código	Potencia W	Anchura de cepillado mm	Profundidad corte mm	Profundidad de galce mm	r.p.m. en vacío	Peso kg	€ / u.
206250	KP0800	620	82	2,5	9	17.000	2,5	208,00
206252	KP0810C	1.050	82	4	25	12.000	3,4	373,00
206251	KP312S	2.200	312	3,5	-	12.000	18,4	2.835,00

Multiherramienta



TM3000CX1



TM3010CX6

Ref.	Código	Potencia W	Oscilaciones por min. o.p.m.	Ángulo de oscilación	Peso kg	€ / u.
208560	TM3000CX1	320	6.000 - 20.000	3,2	1,4	269,00
208561	TM3010CX6	320	6.000 - 20.000	1,6	1,6	310,00

Multiherramienta



Ref.	Código	Modelo	Potencia W	n° de oscilaciones en vacío r.p.m.	placa medida mm	Peso kg	€ / u.
8001412	601406500	MT 400 Quick	400	11000 - 18500	93	1,4	280,16

Lijadora de pared

BOSCH 

Ref.	Código	Modelo	Potencia W	Diámetro del vaso mm	Velocidad r.p.m.	Peso kg	€/ u.
2400501	06017D4000	GTR 55-225 PROFESSIONAL	550	225	340 - 910	4,1	425,00

Lijadora Delta

metabo

FMS 200 Intec



DSE 280 Intec

Ref.	Código	Modelo	Potencia W	Nº oscilaciones con marcha en vacío	Placa mm	Radio oscilat. mm	Peso Kg	€/ u.
207510	600065500	FMS 200 Intec	200	2.600	100 x 147	1,4	1,2	92,70
2400502	600317500	DSE 280 Intec	300	14.000 - 22.000	93 x 93	1,8	1,3	212,18

Lijadora de soldadura en ángulo

metabo

Ref.	Código	Modelo	Potencia W	Revoluciones min	Peso Kg	€/ u.
8000593	602265500	KNSE 9-150 SET	950	900 - 3.800	2,7	978,50

Lijadora de hormigón

BOSCH 

Ref.	Código	Modelo	Potencia W	Diámetro del vaso mm	Rosca del husillo	Velocidad r.p.m.	Peso kg	€/ u.
206771	0601776001	GBR 15 CAG	1.500	125	M14	9.300	2,6	819,00

Lijadora de hormigón



RSEV 17-125



RSEV 19-125

Ref.	Código	Modelo	Potencia W	Ø disco mm	Revoluciones min.	Peso Kg	€/ u.
21080004	603829510	RSEV 17-125	1.700	125	9.600	2.7	572,68
21080005	603825700	RSEV 19-125	1.900	125	6.800	3.5	630,36

Lijadora orbital



GSS 140-1A PROFESSIONAL



GSS 160-1A Multi PROFESSIONAL



GSS 230 AVE PROFESSIONAL

Ref.	Código	Modelo	Potencia W	Medidas placa mm	Nº oscilaciones con marcha en vacío	Nº revoluciones máx. r.p.m.	Peso kg	€/ u.
8000080	06012A2100	GSS 140-1A PROFESSIONAL	180	101 x 113	24.000	12.000	1,2	165,00
8000081	06012A2300	GSS 160-1A Multi PROFESSIONAL	180	80 x 130	24.000	12.000	1,2	239,00
2400503	0601292801	GSS 230 AVE PROFESSIONAL	300	92 x 182	22.000	11.000	2,4	489,00

Lijadora orbital



FSR 200 Intec



SR 2185



SRE 4350



SRE 4351 TurboTec

Ref.	Código	Modelo	Potencia W	Nº oscilaciones con marcha en vacío	Medidas placa mm	Radio oscilat. mm	Peso Kg	€/ u.
206780	600066500	FSR 200 Intec	200	26.000	114 x 102	1,4	1,3	93,73
206784	600441500	SR 2185	210	22.300	92 x 184	2	1,5	148,32
206782	611350000	SRE 4350	350	8.400 - 22.000	92 x 184	2,2	2,4	429,51
206783	611351000	SRE 4351 TurboTec	350	8.400 - 22.000	114 x 299	2,2	2,6	508,82

Lijadora orbital



B04565K



B03711



B04901

Ref.	Código	Potencia W	Medidas placa mm	Ø órbita mm	Dimensiones triángulo mm	r.p.m. en vacío	Vibraciones por minuto v.p.m.	Peso kg	€/ u.
206552	B03711	190	93 x 185	2	-	11.000	22.000	1,6	127,00
206550	B04565	200	112 x 190	1,5	96	14.000	28.000	1,2	137,00
206551	B04901	330	115 x 229	2,6	-	10.000	20.000	2,7	278,00

Lijadora excéntrica



B05031



B06030

Ref.	Código	Potencia W	Ø plato mm	Ø de la órbita mm	r.p.m. en vacío	Peso kg	€/ u.
206732	B05031	300	125	2,8	4.000 - 12.000	1,3	176,00
206733	B06030	310	150	3	4.000 - 10.000	2,4	251,00

Lijadora excéntrica



FSX 200 Intec



SXE 3125



SXE 450 TurboTec

Ref.	Código	Modelo	Potencia W	Nº de revoluciones máx en vacío r.p.m.	Ø plato mm	Ø de la órbita mm	Peso Kg	€/ u.
206910	609225500	FSX 200 Intec	240	11.000	125	2,7	1,3	93,73
206903	600443500	SXE 3125	310	4.000 - 12.000	125	3	1,5	206,00
206902	600129000	SXE 450 TurboTec	350	4.200 - 11.000	150	2,8 / 6,2	2,2	388,31

Lijadora excéntrica



GET 55-125 PROFESSIONAL



GET 75-150 PROFESSIONAL



GEX 125-1 AE PROFESSIONAL



GEX 34-150 PROFESSIONAL



GEX 40-150 PROFESSIONAL

Ref.	Código	Modelo	Potencia W	Nº revoluciones máx. r.p.m.	Peso kg	€/ u.
20014875	0601387500	GEX 125-1 AE PROFESSIONAL	250	12.000	1,6	185,00
21022003	0601372800	GEX 34-150 PROFESSIONAL	340	12.000	2,1	329,00
2400505	0601378201	GEX 40-150 PROFESSIONAL	400	5.500 - 12.000	2,4	409,00
2400504	0601257001	GET 55-125 PROFESSIONAL	550	7.800	2,4	589,00
20014874	0601257101	GET 75-150 PROFESSIONAL	750	7.300	2,6	615,00

Lijadora de banda



BAE 75



BFE 9-20 SET

Ref.	Código	Modelo	Potencia W	Velocidad cinta	Dimensiones cinta mm	Peso Kg	€ / u.
8000083	602244500	BFE 9-20 SET	950	9 -20 m/s	6/19 x 457	1,8	1.031,03
207150	600375000	BAE 75	1.010	240 -450 m/min	75 x 533	4,9	421,27

Lijadora de banda



Ref.	Código	Potencia W	Dimensiones banda mm	Velocidad de la banda m/min.	Peso kg	€ / u.
207250	9032	500	9 x 533	300 - 1700	1,6	278,00
207251	9403	550	30 x 533	200 - 1.000	2,1	353,00

Lijadora para tubos



Ref.	Código	Potencia W	r.p.m. en vacío	Materiales	Tubos hasta mm	Peso kg	€ / u.
2400506	11368	1.400	750-3000	Tubos de plástico, metales no ferrosos y acero inoxidable	180	1,8	394,00

Satinadora inox



SE 17-200 RT

SE 17-200 RT Set

Ref.	Código	Modelo	Potencia W	Ancho máx. del accesorio mm	Peso kg	Ø máx. accesorio mm	r.p.m. en vacío	Peso Kg	€/ u.
8000084	602259000	SE 17-200 RT	1.700	100	2,7	100 - 200	800 - 3.000	2,9	510,88
8000085	602259500	SE 17-200 RT Set	1.700	100	6,1	100 - 200	800 - 3.000	2,9	831,21

Satinadora



Ref.	Código	Potencia W	Ancho máx. del accesorio mm	r.p.m. en vacío	Peso kg	€/ u.
2400507	1.1804	1.300	100	1.000-3.000	4.1	231,00

Amoladora angular Inox



Ref.	Código	Modelo	Potencia W	Ø disco mm	Revoluciones min.	Peso Kg	€/ u.
207162	613080000	WEVF 10-125 Quick Inox	1.000	125	2.000 - 7.600	2,3	513,97
20041223	600517000	WEV 17-125 Quick Inox	1.700	125	2.000 - 7.600	2,5	381,10

Pulidora



Ref.	Código	Modelo	Potencia W	Nº revoluciones máx. r.p.m.	Ø plato mm	Peso kg	€/ u.
202410	0601389000	GPO 14 CE	1.400	750 - 3.000	180	2,5	315,00

Pulidora



Ref.	Código	Modelo	Potencia W	Ø disco mm	Revoluciones min.	Peso Kg	€/ u.
8005461	615200000	PE 15-20 RT	1.500	178	300 - 1900	3	464,53

Fresadora



GKF 600 PROFESSIONAL



GOF 1250 LCE PROFESSIONAL

Ref.	Código	Modelo	Potencia W	Admisión de fresas de mm	Nº revoluciones máx. r.p.m.	Velocidad de giro en vacío, hasta	Peso kg	€/ u.
8000087	060160A100	GKF 600 PROFESSIONAL	600	6 a 8	33.000	33.000	1,5	285,00
2400508	0601626001	GOF 1250 LCE PROFESSIONAL	1.250	6 a 8	24.000	24.000	3,6	615,00

Fresadora, motor de fresado y de lijado



FM 500-6



OFE 738

Ref.	Código	Modelo	Potencia W	Capacidad de la pinza Ø mm	Revoluciones min.	Peso Kg	€/ u.
2400509	601741000	FM 500-6	500	6	32.000	1,3	82,40
207900	600738000	OFE 738	710	8	13.000 - 34.000	3	421,27

Fresadora



RT0702C



RP0900

Ref.	Código	Potencia W	Capacidad de la pinza Ø mm	Profundidad corte mm	r.p.m. en vacío	Peso kg	€/ u.
2400510	RT0702C	710	8 / 6	35	10.000 - 30.000	1,8	208,00
207950	RP0900	900	8	0 - 35	27.000	2,7	186,00

Fresadora para pernios



Ref.	Código	Modelo	Potencia W	Fresas Inserción mm	€/ u.
2400511	1.2141	PRP 6	480	6 y 8	137,00

Rozadora



GNF 35 CA



GNF 65 A

Ref.	Código	Modelo	Potencia W	Profundidad ajustable del surco	Ancho de ranura, desde	Ancho de ranura, hasta	Peso kg	€/ u.
8004518	0601621703	GNF 35 CA	1.400	0 - 35	3	39	4,7	862,00
8004519	0601368703	GNF 65 A	1.400	20 - 65	3	40	8,4	1.329,00

Rozadora



Ref.	Código	Modelo	Potencia W	Profundidad de corte ajustable mm	Ø disco mm	Revoluciones min.	Peso Kg	€/ u.
8000090	604040500	MFE 40	1.900	10 - 40	125	5.000	4,6	824,00

Rozadora



Ref.	Código	Modelo	Potencia W	Ø disco mm	Profundidad de corte ajustable mm	Revoluciones min.	Peso Kg	€/ u.
2400512	1.1654	RF 1100 K	1.100	78	25	1.600	6,5	527,00
2400514	1.6007	CD 180 K	1.800	180	54	4.100	7,7	833,00
2400513	1.6007	CD 150 B 4	2.400	150	43	8.000	6	833,00

Decapador



GHG 20-63 PROFESSIONAL



GHG 20-60



GHG 23-66 PROFESSIONAL

Ref.	Código	Modelo	Potencia W	Caudal de aire l/min	Temperatura de aire °C	Peso kg	€ / u.
2400515	06012A6201	GHG 20-63 PROFESSIONAL	2.000	150-300/300-500	50/630	0,7	205,00
8000091	06012A6400	GHG 20-60	2.000	150-300/300-500	50/630	0,55	215,00
20014828	06012A6300	GHG 23-66 PROFESSIONAL	2.300	500	50/630	0,65	232,00

Decapador



HG 20-600



HGS 22-630

Ref.	Código	Modelo	Potencia W	Temperatura de aire °C	Caudal de aire l/min	Maletín	Peso Kg	€ / u.
21080007	601067500	HG 16-500	1.600	300 / 500	240 / 450	SI	0,6	144,20
21080008	602066500	HG 20-600	2.000	80 - 600	150 / 300 / 500	SI	0,62	169,95
21080010	604063500	HGS 22-630	2.200	80 - 630	150 / 500	SI	0,65	178,19
21080009	603065500	HGE 23-650 LCD	2.300	80 - 650	150 - 500	SI	0,7	212,18

Decapador



Ref.	Código	Potencia W	Caudal de aire l/min	Temperatura de aire °C	Peso kg	€ / u.
208360	HG5030K	1.600	350 / 500	500	0,6	112,00
208361	HG6531CK	2.000	200 / 550	650	0,6	245,00



HG5030K



HG6531CK

Pistola de encolar



Ref.	Código	Modelo	Adherencia máx. g/min.	Temperatura de trabajo	Maletín	Ø barra de pegar	Peso Kg	€ / u.
208500	618121000	KE 3000 (TEMPERATURA CONSTANTE)	18	200 °C	SI	11 mm	0,5	127,72



Taladro atornillador



DV12DA

DV18DD

Ref.	Código	Tensión V	Compatible con MV	Brushless	Apriete Nm	Capacidad acero mm	Capacidad madera mm	Capacidad mampostería mm	Batería Ah	Peso Kg	€ / u.
213671	DV18DCWPZ	18	si		55	13	38	13	1.5	1.7	591,22
21049043	DV12DA	12 PEAK (10,8V)			38	10	29	8	2.5	1.2	229,69
21049045	DV18DD	18	si	si	55	13	36	13	3.0	1.2	269,86
21049047	DV36DCWZ	36	si	Si	138	13	76	13		2	386,25

Taladro atornillador



BS 18

BS 18 L

BS 18 L Quick

BS 18 LT Compact

BS 18 LT BL

BS 18 LTX BL Q I

BS 18 LTX BL Q I (carcasa)

Ref.	Código	Modelo	Tensión V / Ah	r.p.m. en vacío	Capacidad máx en madera mm	Capacidad máx en acero mm	Par de giro máx atornillado duro Nm	Par de giro máx atornillado blando Nm	Motor Brushless	Peso Kg	€ / u.
20044625	601036500	PowerMaxx BS 12	12 V / 2 x 2,0Ah	0 - 360 / 0 - 1400	18	10	40	17		0.25	178,19
2400516	602207560	BS 18	12 V / 2 x 2,0Ah	1.600	20	10	48	24		1.3	200,85
8000097	602321500	BS 18 L	18 V / 2 x 2,0 Ah	0 - 450 / 0 - 1800	20	10	50	25		1.3	240,00
8000098	602320500	BS 18 L Quick	18 V / 2 x 2,0 Ah	0 - 450 / 0 - 1800	20	10	50	25		1.6	339,90
20044588	602102530	BS 18 LT Compact	18 V / 2 x 2,0 Ah	0 - 450 / 0 - 1600	38	13	60	34		1.6	284,28
8000099	602325500	BS 18 LT BL	18 V / 2 x 4,0 Ah	0 - 600 / 0 - 2100	38	13	60	34	SI	1.6	339,90
20044594	602191840	BS 18 LTX Impuls (carcasa)	18V / sin baterías, sin cargador	0 - 500 / 0 - 1700	65	13	110	60		1.7	335,78
2400517	602359840	BS 18 LTX BL Q I	18V / sin baterías, sin cargador	0 - 550 / 0 - 2000	68	13	130	65	SI	1.7	418,18
21080013	602359840	BS 18 LTX BL Q I (carcasa)	18V / sin baterías, sin cargador	0 - 550 / 0 - 2000	68	13	130	65	SI	2,3 con batería	418,18

Taladro atornillador y combinado

Makita

DF347D001



DF488D004

Ref.	Código	Tensión V	Capac. máx. madera mm	Par máx. apriete blando	Par máx. apriete duro	Capacidad máx. acero mm	r.p.m. en vacío	Peso kg	€ / u.
2400518	DF347D001	14,4 (1,5Ah)	25	15	30	10	0 - 400/1400	1,4	251,00
2400519	DF488D004	18 (2,0Ah)	36	27	42	13	0 - 400/1400	1,7	253,00

Taladro atornillador

STAYER

Ref.	Código	Modelo	Batería V / Ah	Motor Brushless	Peso Kg	€ / u.
2400520	12580	DWS L20	18V / sin baterías, sin cargador	SI	1,2	190,00

Taladro atornillador

HIKOKI

Ref.	Código	Tensión V	Compatible con MV	Brushless	Apriete Nm	Capacidad acero mm	Capacidad madera mm	Batería Ah	Peso Kg	€ / u.
213686	DS18DCWPZ	18	si		136	13	76	5.0	2.5	311,00
21049039	DS18DAWCZ	18	si		53	13	38	1.5	1.7	174,07
21049040	DS18DDWRZ	18	si	si	55	13	36	3.0	1.2	237,00
21049041	DS18DEWFZ	18	si	si	70	13	50	5.0	1.9	425,39
21049042	DS36DCWZ2	36	si	si	138	16	102		2	359,47

Atornillador angular



GSR 12V-15 FC GSR 12V-35 FC (full set) PROFESSIONAL

Ref.	Código	Modelo	Nº de velocidades	Par de giro máx. (duro/blando)	Peso kg	€/ u.
8000102	06019F6004	GSR 12V-15 FC	2	30 / 15	0,6	129,00
2400521	06019H3000	GSR 12V-35 FC (full set) PROFESSIONAL	2	35 / 20	1	449,00

Taladro percutor



GSB 12V-15 PROFESSIONAL GSB 18V-45 PROFESSIONAL GSB 18V-110 C PROFESSIONAL

Ref.	Código	Modelo	Nº de velocidades	Ø máx. perforación en mampostería mm	Ø máx. perforación en madera mm	Velocidad r.p.m.	Peso kg	€/ u.
2400522	06019B690H	GSB 12V-15 PROFESSIONAL	2	10	19	0 - 380 / 0 - 1.300	1	207,00
2400523	06019K3302	GSB 18V-45 PROFESSIONAL	2	10	35	0 - 500 / 0 - 1.900	1	298,00
20015247	06019G030B	GSB 18V-110 C PROFESSIONAL	2	16	82	0 - 480/2.100	2	599,00

Taladro percutor



PowerMaxx SB 12 BL SB 18 LT BL SB 18 LTX Impuls SB 18 LTX BL Q I SB 18 LTX BL I SB 18 LTX-3 BL Q I Metal

Ref.	Código	Modelo	Tensión V / Ah	r.p.m. en vacío	Capacidad máx en madera mm	Capacidad máx en acero mm	Par de giro máx atornillado duro Nm	Par de giro máx atornillado blando Nm	Motor Brushless	Peso Kg	€/ u.
20044704	601076500	PowerMaxx SB 12	12 V / 2 x 2,0Ah	0 - 360 / 0 - 1400	18	10	40	17		2,3 con batería	189,52
2400524	601046500	PowerMaxx SB 12 BL	12 V / 2 x 2,0Ah	0 - 450 / 0 - 1600	35	10	45	20	0.9		224,00
215986	602103510	SB 18 LT Compact	18 V / 2 x 2,0 Ah	0 - 450 / 0 - 1600	38	13	60	34		1.1	284,28
8000108	602316500	SB 18 LT BL	18 V / 2 x 4,0 Ah	0 - 600 / 0 - 2100	38	13	60	34	SI	1.7	339,90
20044685	602192840	SB 18 LTX Impuls (carcasa)	18V / sin baterías, sin cargador	0 - 500 / 0 - 1700	65	13	110	55		1.8	335,78
2400525	602361840	SB 18 LTX BL Q I (Carcasa)	18V / sin baterías, sin cargador	0 - 550 / 0 - 2000	68	13	130	65	SI	1,8	418,18
21080014	602360840	SB 18 LTX BL I (carcasa)	18V / sin baterías, sin cargador	0 - 550 / 0 - 2000	68	13	130	65	SI	2,2 con batería	371,83
21080015	602361840	SB 18 LTX BL Q I (carcasa)	18V / sin baterías, sin cargador	0 - 550 / 0 - 2000	68	13	130	65	SI	2,4 con batería	418,18
2400526	603182840	SB 18 LTX-3 BL Q I Metal (Carcasa)	18V / sin baterías, sin cargador	0 - 450 / 0 - 2000 / 0 - 4000	68	16	130	65	SI	2,1	444,96

Taladro percutor



Ref.	Código	Tensión V	Capac. máx. madera mm	Nº Percusiones i.p.m.	Par máx. apriete blando	Capacidad máx. acero mm	r.p.m. en vacío	Tensión V	Peso kg	€/ u.
2400527	HP347D001	14,4 (1,5Ah)	25	0 - 6.000/21.000	15	10	0 - 400/1.400	14,4 (1,5Ah)	1,5	200,00
2400528	HP488D002	18 (1,5Ah)	36	0 - 6.000/21.000	27	13	0 - 400/1.400	18 (1,5Ah)	1,7	249,00
2400529	DHP487RAJ	18 (2,0Ah)	36	0 - 7.500/25.500	23	13	0 - 500/1.700	18 (2,0Ah)	1,7	463,00
213693	DHP453RFE	18 (3,0Ah)	36	0 - 6.000/19.500	27	42	13	0 - 400/1.300	1,8	429,00

Taladro percutor



GSB 18V-55 PROFESSIONAL GSB 18V-90 C PROFESSIONAL

Ref.	Código	Modelo	Nº de velocidades	Ø máx. perforación en mampostería mm	Ø máx. perforación en madera mm	Velocidad r.p.m.	Peso kg	€/ u.
2400530	06019H5304	GSB 18V-55 PROFESSIONAL	2	13	35	0 - 460/1.800	1,1	409,00
2400531	06019K6104	GSB 18V-90 C PROFESSIONAL	2	13	68	0 - 630 / 0 - 2.100	1,2	469,00

Atornillador



Ref.	Código	Modelo	Par de giro máx. (en atornillado blando)	Portaherramientas	Velocidad de giro en vacío	Peso kg	€/ u.
2400532	06019K6004	GSR 18V-90 C PROFESSIONAL	64	Hexágono interior de 1/4"	0 - 630 / 0 - 2.100	1,1	459,00
2400533	06019K6205	GSR 18V-90 FC PROFESSIONAL	64	Hexágono interior de 1/4"	0 - 630 / 0 - 2.100	0,62	835,00
20014709	06019G010A	GSR 18V-110 C PROFESSIONAL	47	Hexágono interior de 1/4"	0 - 480 / 0 - 2.100	0,62	585,00
2400534	06019J5005	GSR 18V-150 C PROFESSIONAL	150	Hexágono interior de 1/4"	0 - 550 / 0 - 2.200	2,1	779,00
20014727	06019H3004	GSR 12V-35 FC PROFESSIONAL	20	Hexágono interior de 1/4"	0 - 1.750	0,59	169,00
21022018	06019J9103	GSR 12V-35 HX PROFESSIONAL	20	Hexágono interior de 1/4"	0 - 1.750	0,59	175,00
2400535	06019K7001	GTB 18V-45 PROFESSIONAL	6	Hexágono interior de 1/4"	0 - 4.500	1,8	272,00
2400536	06019K7002	GTB 18V-45 PROFESSIONAL	6	Hexágono interior de 1/4"	0 - 4.500	1,8	549,00





Martillo



Ref.	Código	Modelo	Tensión V / Ah	Energía máx Impacto (EPTA)	Inserción	Capacidad máx en hormigón mm	Peso Kg	€/ u.
21080017	600324500	BH 18 LTX BL 16	18 V / 2 x 2.0 Ah	1,3 J	SDS-plus	16	1,7 con batería	387,28
2400537	601712800	KH 18 LTX 24	18V / 2 x 4 Ah LiHD	2,1 J	SDS-plus	24	2.6	523,24
2400538	601714930	KH 18 LTX BL 24 Q Set ISA	18 V / 2 x LiHD 5,5 Ah	2,2 J	SDS-plus	24	4.1	900,22
2400539	600796840	KHA 36-18 LTX 32 (Carcasa)	18V / sin baterías, sin cargador	3,1 J	SDS-plus	32	3.8	642,72
21080018	600752840	KHA 18 LTX BL 40 (carcasa)	18V / sin baterías, sin cargador	8,6 J	SDS-Max	40	5,8 con batería	610,79

Martillo



Ref.	Código	Modelo	Fuerza J	N° impactos máx. i.p.m.	Ø máx. perforación en hormigón mm	Portaherramientas	Peso kg	€/ u.
21022005	0611914001	GBH 18V-34 CF PROFESSIONAL	5.8	2.900	8 - 32	SDS-plus	4,9	809,00
21022006	0611914003	GBH 18V-34 CF PROFESSIONAL	5.8	2.900	8 - 32	SDS-plus	4,9	1.179,00
21022026	0611924001	GBH 18V-22 Professional	2	5.100	4 - 21	SDS-plus	3,2	314,00
8000026	0611910002	GBH 18V-26 PROFESSIONAL	2.6	4.350	4 - 26	SDS-plus	3,6	779,00
2400540	0611923003	GBH 18V-24 C PROFESSIONAL	2.4	4.350	4 - 24	SDS-plus	3.5	619,00
2400541	0611921003	GBH 18V-28 CF PROFESSIONAL	3.4	4.220	4 - 28	SDS-plus	3.4	1.159,00
21022007	0611915003	GBH 18V-36 C PROFESSIONAL	7	2.900	14 - 35	SDS-max	5,1	1.229,00
21022008	0611913000	GBH 18V-45 C PROFESSIONAL	12.5	2.760	12 - 45	SDS-max	7,8	1.289,00
2400542	0611917102	GBH 18V-40 C PROFESSIONAL	9	3.130	12 - 40	SDS-max	7	1.429,00
2400543	0611913002	GBH 18V-45 C PROFESSIONAL	12.5	2.720	12 - 45	SDS-max	8	1.839,00

Martillo

HIKOKI



Ref.	Código	Tensión V	Compatible con MV	Brushless	Revoluciones min.	Percusiones ipm	Inserción	RFC	Modos uso	LVH	Capacidad hormigon mm	Capacidad acero mm	Peso Kg	€ / u.
21049064	DH3628DAWZ	36	si	si	0-1.100	0-4.300	SDS Plus	si	3		28	13	3.9	465,56
21049065	DH36DMAW2	36	si	si	260-590	2.860	SDS Max	si	2	si	40	13	7.2	679,80

Vibrador de hormigón

HIKOKI



Ref.	Código	Tensión V	Compatible con MV	Brushless	Diametro eje mm	Prof. Máx de trabajo mm	Niveles vibración/min	Peso Kg	€ / u.
21049076	UV3628DAW4	36	si	si	28	824	12.000/15.200	3.17	410,97

Mezcladores

HIKOKI



Ref.	Código	Tensión V	Compatible con MV	Brushless	Velocidad	Rosca varilla	Peso Kg	€ / u.
21049075	UM36DAW4	36	si	si	0-500/0-1.200	M14	3.8	433,63

Miniamoladora

BOSCH



GWS 18V-10 PROFESSIONAL



GWS 18V-7 PROFESSIONAL



GWS 18V-10 PROFESSIONAL



GWX 18V-10 PROFESSIONAL



Ref.	Código	Modelo	N° revoluciones máx. r.p.m.	Ø disco mm	Peso kg	€ / u.
21022009	06019J4003	GWS 18V-10 PROFESSIONAL	9.000	125	1,682	259,00
21022010	06019H9005	GWS 18V-7 PROFESSIONAL	11.000	125	1,444	459,00
21022011	06019J4007	GWS 18V-10 PROFESSIONAL	9.000	125	1,674	499,00
21022012	06017B0101	GWX 18V-10 PROFESSIONAL	9.000	125	1,545	289,00
2400544	0615990N33	GWS 18V-10 SC (125 mm) PROFESSIONAL	4500 - 9000	125	2.8	629,00
2400545	06019G3F0E	GWS 18V-10 PSC PROFESSIONAL	4500 - 9000	125	2.8	719,00
21022015	06019H6100	GWS 18V-15 SC PROFESSIONAL	9.800	125	1,745	449,00
21022016	06019H6402	GWX 18V-15 C PROFESSIONAL	9.000	125	3,2	819,00

Miniamoladora



Ref.	Código	Tensión V	r.p.m. en vacío	Rosca del husillo	Ø exterior del disco mm	€/ u.
210170	DGA452RME	18 (3,0 Ah)	10.000	M14	115	543,00

Miniamoladora



WF 18 LTX (Ø 125 mm) (carcasa)



W 18 L 9-125



W 18 L 9-125



WB 18 LT BL 11-125 Quick



WPB 18 LT BL 11-125 Quick (Carcasa)

Ref.	Código	Modelo	Tensión V / Ah	Ø disco mm	Interruptor Hombre Muerto	Freno	Motor Brushless	Revoluciones min.	Peso kg	€/ u.
20041292	601306840	WF 18 LTX (Ø 125 mm) (carcasa)	18V / sin baterías, sin cargador	125				8.000	0,9	427,45
2400546	602247840	W 18 L 9-125	18V / sin baterías, sin cargador	125				8.500	1,5	203,94
2400547	602247510	W 18 L 9-125	18 V / 2 x 4,0 Ah	125				8.500	2,7	424,36
2400548	613054660	WB 18 LT BL 11-125 Quick	18 V / 2 x LiHD 5,5 Ah	125		si	SI	10.000	1,5	610,79
2400549	613059840	WPB 18 LT BL 11-125 Quick (Carcasa)	18V / sin baterías, sin cargador	125	si	si	SI	10.000	1,5	424,36

Miniamoladora



G18DSL2WUZ



G3613DEW2Z



G3613DFW2Z



G3623DAW4

Ref.	Código	Tensión V	Compatible con MV	Brushless	Revoluciones min.	Ø del disco mm	Interruptor	Peso Kg	€/ u.
21049048	G1813DAWQZ	18	si	si	9.000	125		2,7	467,62
21049050	G18DSL2WUZ	18	si		9.100	125		1,8	452,00
21049051	G3613DEW2Z	36	si	si	3.000 - 9.500	125		2,1	270,00
21049052	G3613DFW2Z	36	si	si	3.000 - 9.500	125	pala	2,1	270,00
21049053	G3623DAW4	36	si	si	5.300	230		4	611,82

Amoladora recta

BOSCH 

GGS 18V-23 LC PROFESSIONAL

GGS 18V-23 PLC PROFESSIONAL

GGS 18V-10 SLC PROFESSIONAL

Ref.	Código	Modelo	N° revoluciones máx. r.p.m.	Portaherramientas	Peso kg	€/ u.
20014690	0601229100	GGS 18V-23 LC PROFESSIONAL	23.000	Pinzas de sujeción hasta 8 mm Ø	1,4	369,00
20014691	0601229200	GGS 18V-23 PLC PROFESSIONAL	23.000	Pinzas de sujeción hasta 8 mm Ø	1,4	385,00
21022017	06012B4000	GGS 18V-10 SLC PROFESSIONAL	10.500	Pinzas de sujeción hasta 8 mm Ø	1,6	493,00

Amoladora recta

metabo

GVB 18 LTX BL 11-28

GVB 18 LTX BL 11-28 Compact

GVB 18 LTX BL 11-7 HT

Ref.	Código	Modelo	Tensión V / Ah	Ø orificio pinza mm	Revoluciones min.	Peso Kg	€/ u.
2400550	600826850	GVB 18 LTX BL 11-28	18V / sin baterías, sin cargador	6	80000 - 28000	1,4	300,00
2400551	600828850	GVB 18 LTX BL 11-28 Compact	18V / sin baterías, sin cargador	6	80000 - 28000	1,1	260,00
2400552	600829850	GVB 18 LTX BL 11-7 HT	18V / sin baterías, sin cargador	6	1500 07000	1,5	400,00

Satinadora inox

metabo

Ref.	Código	Modelo	Tensión V / Ah	r.p.m. en vacío	Ø Muela mm	Peso Kg	€/ u.
213900	600154850	S 18 LTX 115	18V / sin baterías, sin cargador	3.000	100 - 200	3,1	725,12

Lijadora excéntrica

metabo

SXA 18 LTX 125 (carcasa)

SXA 18 LTX 150 BL

Ref.	Código	Modelo	Tensión V / Ah	N° de revoluciones máx en vacío r.p.m.	Ø plato mm	Ø de la órbita mm	Peso Kg	€/ u.
21080020	600146840	SXA 18 LTX 125 (carcasa)	18V / sin baterías, sin cargador	4.000 - 10.000	125	2	1,8	250,29
2400553	600411840	SXA 18 LTX 150 BL	18V / sin baterías, sin cargador	4.000 - 10.000	150	3	1,3	329,60

Lijadora de soldadura en ángulo especial inox



Ref.	Código	Modelo	Tensión V / Ah	r.p.m. en vacío	Ø disco mm	Peso Kg	€/ u.
213920	600191850	KNS 18 LTX150	18V / sin baterías, sin cargador	3.800	150	3	958,93

Lijadora de banda "en punta" especial inox



Ref.	Código	Modelo	Tensión V / Ah	Velocidad cinta en vacío m/s	Longitud brazo lijador mm	Peso Kg	€/ u.
213940	600321850	BF 18 LTX 90	18V / sin baterías, sin cargador	8	90	2,6	725,12

Lijadora de cinta para tubos



Ref.	Código	Modelo	Tensión V / Ah	Velocidad cinta en vacío m/s	Cinta mm	Peso Kg	€/ u.
213725	600192850	RB 18 LTX	18V / sin baterías, sin cargador	9,2	75 x 533	3,3	958,93

Atornillador



Ref.	Código	Modelo	Tensión V / Ah	r.p.m. en vacío	Par de giro máx atornillado blando Nm	Portaherramientas	Peso Kg	€/ u.
2400554	620062500	HBS 18 LTX BL 3000	18 V / 2 x 2,0 Ah	0 - 3000	10	Hexagono interior 1/4"	1	382,13

Atornillador



Ref.	Código	Modelo	Tensión V / Ah	r.p.m. en vacío	Par de giro máx atornillado blando Nm	Portaherramientas	Peso Kg	€ / u.
2400555	620063540	TBS 18 LTX BL 5000 + Speed Fix 57	18 V / 2 x LiHD 4.0 Ah	0 - 5000	6	Hexagono interior 1/4"	0.9	594,31

Atornillador placa yeso



Ref.	Código	Modelo	Tensión V / Ah	r.p.m. en vacío	Par de giro máx atornillado blando Nm	Portaherramientas	Peso Kg	€ / u.
2400556	620063500	TBS 18 LTX BL 5000	18 V / 2 x 2,0 Ah	0 - 5000	6	Hexagono interior 1/4"	0.9	382,13

Atornillador de impacto



GDR 18V-160 PROFESSIONAL



GDR 18V-200 PROFESSIONAL



GDX 18V-210 C PROFESSIONAL



GDS 18V-300 PROFESSIONAL



GDS 18V-450 HC PROFESSIONAL



GDS 18 V-1050 H PROFESSIONAL



Ref.	Código	Modelo	Par de giro máx.	Portaherramientas	Velocidad r.p.m.	Nº de impactos	Peso kg	€ / u.
8000119	06019G5100	GDR 18V-160 PROFESSIONAL	160	Hexágono interior de 1/4" y cuadrado exterior 1/2"	0 - 2.800	0 - 3.600	1,02	339,00
2400557	0615990NOY	GDR 18V-200 PROFESSIONAL	200	Hexágono interior de 1/4" y cuadrado exterior 1/2"	0 - 3.400	0 - 4.000	1,1	509,00
2400558	06019J0203	GDX 18V-210 C PROFESSIONAL	210	1/4" hex uni , 1/2" cuadrado	0 - 3.400	0 - 4.100	1,2	569,00
21022019	06019L5002	GDS 18V-330 HC Professional	300	Cuadrado macho de 1/2"	0 - 2.400	0 - 3.400	1,3	589,00
2400559	06019K4003	GDS 18V-450 HC PROFESSIONAL	450	Cuadrado macho de 1/2"	0 - 2.300	0 - 3.300	1,6	559,00
21022020	06019J8503	GDS 18 V-1050 H PROFESSIONAL	1.050	Cuadrado macho de 3/4"	0 - 1.750	0 - 2.600	2,9	779,00



Atornillador de impacto



PowerMaxx SSD PowerMaxx SSD 12 BL SSD 18 LTX 200 BL SSW 18 LTX 300 BL 1/2" SSW 18 LTX 400 BL

Ref.	Código	Modelo	Tensión V / Ah	r.p.m. en vacío	Nº max de golpes impacto	Inserción	Par máx. apriete Nm	Motor Brushless	Peso Kg	€ / u.
2400560	601115500	PowerMaxx SSD	12 V / 2 x 2,0 Ah	0 - 2500	4.000	1/4" Hex. Interior	140	SI	1	258,53
8000121	602396800	SSD 18 LTX 200 BL	18 V / 2 x LiHD 4,0 Ah	2.900	4.000	1/4" Hex. Interior	200	SI	1,4	593,28
8000122	602395800	SSW 18 LTX 300 BL 1/2"	18 V / 2 x LiHD 4,0 Ah	0 - 2650	3.750	cuadradillo 1/2"	300	SI	1,7	593,28
8000123	602205800	SSW 18 LTX 400 BL	18 V / 2 x LiHD 4,0 Ah	0 - 2150	4.250	cuadradillo 1/2"	400	SI	1,9	660,23

Atornillador de impacto



TD022DSE TD110DSAE DTD152RTJ DTW700RTJ DTD154RTJ

Ref.	Código	Tensión V	Inserción	Nº Percusiones i.p.m.	Par máx. apriete Nm	Capacidad máx. (mm)	r.p.m. en vacío	Peso kg	€ / u.
8000124	TD022DSE	7,2 (1,0Ah)	1/4" Hex.	3.000	22	8	2.450	0,5	233,00
210365	TD110DSAE	10,8	1/4" Hex.	0 - 3.000	110	M5 - M12	0 - 2.400	0,9	239,00
210370	DTD152RTJ	18 (4,0Ah)	1/4" Hex.	0 - 3.200	160	M5 - M14	0 - 2.400	1,5	567,00
2400561	DTW700RTJ	18 (5,0Ah)	1/2"	0 - 2.700	700	M10 - M24	0 - 2.200	2,7	757,00
8000125	DTD154RTJ	18 (5,0Ah)	1/4" Hex.	0 - 1.100/2.600/3.800	175	M5 - M16	0 - 1.100/2.600/3.800	1,5	673,00

Atornillador de impacto



WH12DA WH12DD WH18DD WR18DHPZ WR36DBW2 WR36DAW2

Ref.	Código	Tensión V	Compatible con MV	Brushless	Revoluciones min.	Apriete Nm	Percusiones ipm	Inserción	Triple Hammer	IP56	Peso Kg	€ / u.
21049054	WH12DA	12 PEAK (10,8V)				110		1/4"			1,1	267,80
21049055	WH12DD	12 PEAK (10,8V)		si		135		1/4"			1,1	409,94
21049056	WH18DD	18	si	si	0-3.200	140		1/4"			1,2	318,27
21049057	WH18DCWFZ	18	si	si	0-2.900/0-900	207		1/4"	si	si	1,6	401,70
21049060	WH36DCWZ	36	si	si	0-2.900/0-900	210	900	1/4"	si	si	1,6	366,68
21049061	WR36DBW2	36	si	si	0-1.500	1.050	0-2.800	1/2"		s	3	466,59
21049062	WR36DAW2	36	si	si	0-2.100	1.100	0-2.800	3/4"		si	3	475,86

Atornillador de impacto



IWB 750 L20



IWB 1000 L20

Ref.	Código	Modelo	Batería V / Ah	r.p.m. en vacío	N° max de golpes impacto	Inserción	€ / u.
2400562	1.2845	IWB 750 L20	18 V / 1X Li-Ion 4,0 Ah	0-2400	2.400	cuadradillo 1/2"	330,00
2400563	1.2791	IWB 1000 L20	18 V / 1X Li-Ion 4,0 Ah	0-1700	2.100	cuadradillo 1/2"	490,00

Multiherramienta



Ref.	Código	Modelo	Tensión V / Ah	N° de oscilaciones en vacío r.p.m.	Placa medida mm	Peso kg	€ / u.
8001413	613021510	MT 18 LTX	18 V / 2 x 2,0 Ah	7000 - 18000	93	1,8	508,82

Cizalla



GSC 18V-16 PROFESSIONAL



GSC 12V-13 PROFESSIONAL

Ref.	Código	Modelo	Capacidad máx de corte en aluminio	Acero hasta 400 N/mm2	Marcha en vacío r.p.m.	Peso kg	€ / u.
2400564	601926301	GSC 18V-16 PROFESSIONAL	2,2	1,6	3.200	1,6	869,00
20014822	601926105	GSC 12V-13 PROFESSIONAL	2	1,3	3.600	1,4	385,00

Cizalla



Ref.	Código	Modelo	Tensión V / Ah	Cap. Acero de 600 N/mm2	Cap. Acero de 400 N/mm2	Velocidad de corte m/min	Peso Kg	€ / u.
20044711	601615840	SCV 18 LTX BL 1.6 (carcasa)	18V / sin baterías, sin cargador	1,2	1,6	7	1,33 con batería	592,25

Punzonadora

BOSCH 

Ref.	Código	Modelo	Aluminio hasta 250 N/mm ²	Acero hasta 400 N/mm ²	Marcha en vacío r.p.m.	Peso kg	€/ u.
2400565	0601529601	GNA 18V-16 E PROFESSIONAL	2	1.6	1.400	1.7	929,00

Fresadora

BOSCH 

GKF 12V-8 PROFESSIONAL



GKF 12V-8 PROFESSIONAL

Ref.	Código	Modelo	Admisión de fresas de mm	Velocidad de giro en vacío, hasta	Peso kg	€/ u.
8000089	06016B0002	GKF 12V-8 PROFESSIONAL	6 a 8	13.000	1,1	245,00
20014832	06016B0000	GKF 12V-8 PROFESSIONAL	6 mm / 8 mm / 1/4"	13.000	1,1	439,00

Pistola para sellantes

 **STAYER**

Ref.	Código	Modelo	Batería V / Ah	Cartuchos hasta ml	€/ u.
2400566	1.2760	CG L20	18V / sin baterías, sin cargador	310	222,00

Sierra circular



Ref.	Código	Modelo	Profundidad de corte 45°/90° mm	Ø disco mm	Peso kg	€/ u.
8000128	06016A1001	GKS 12V-26	17 / 26.5	85	1,4 con batería	205,00
20015173	06016A2101	GKS 18V-57 G PROFESSIONAL	42/57	165	4,1	325,00
2400567	06016C1202	GKS 18V-57-2 Professional	42/57	165	4,1	745,00
21022021	0615990M94	GKS 18V-68 GC + FSN 1400 Professional	50/68	190	7,2	1.049,00
21022022	06016B5100	GKS 18V-68 GC PROFESSIONAL	50/68	190	7,2	589,00

Sierra circular



Ref.	Código	Modelo	Tensión V / Ah	r.p.m. en vacío	Profundidad de corte a 45°/90° mm	Ø hoja mm	Peso Kg	€/ u.
8000126	601857840	KS 18 LTX 57	18V / sin baterías, sin cargador	4.600	43 / 57	165 x 20	3,4	344,02
21080021	611866840	KS 18 LTX 66 BL (carcasa)	18V / sin baterías, sin cargador	4.000	43 / 66	190 x 30	4,5	412,00
2400568	601866810	KT 18 LTX 66 B	18 V / 2 x LiHD 8,0 Ah	2.250 - 5.000	43 / 66	165 x 30	5,3 con baterías	859,02

Sierra circular



Ref.	Código	Tensión V	Compatible con MV	Brushless	Capacidad a 90° mm	Capacidad a 45° mm	rpm/min	Ø del disco mm	Mov. Hoja	Peso kg	Peso Kg	€/ u.
21049069	C3606DBW2Z	36	si	si	66	45	3.400	165	Circular	2,6	2,7	359,00



Ingletadora

HIKOKI



Ref.	Código	Tensión V	Compatible con MV	Brushless	Revoluciones min.	Ø del disco mm	Cap. Máxima de corte mm	Angulo disco	Angulo base	Peso Kg	€/ u.
21049074	C3607DAWZZ	36	si	si	4.000	255	292 (ancho) x 89 (alto)	0-60° der / 0-55° izq	0-48° der / 0-48° izq	20,6	372,86

Ingletadora

BOSCH



Ref.	Código	Modelo	Capacidad de corte a 0°	Capacidad de corte a 45° de inglete, altura	Peso kg	€/ u.
21022023	0601B41002	GCM 18V-216 PROFESSIONAL	70 x 270	70 x 190	14,7	1.129,00

Sierra de sable

BOSCH



GSA 12V-14 PROFESSIONAL



GSA 18 V-LI PROFESSIONAL

Ref.	Código	Modelo	N° carreras por minuto c.p.m.	Sierra longitud de la carrera mm	Peso kg	€/ u.
8000131	060164L905	GSA 12V-14 PROFESSIONAL	0 - 3.000	14,5	1,2	197,00
20015220	060164J007	GSA 18 V-LI PROFESSIONAL	0 - 2700	28	2,5	285,00

Sierra de sable

metabo



PowerMaxx SSE 12 BL



SSE 18 LTX

Ref.	Código	Modelo	Tensión V / Ah	N° carreras por minuto	Longitud de carrera mm	Peso Kg	€/ u.
20044504	602322500	PowerMaxx SSE 12 BL	12 V / 2 x 2,0 Ah	0 - 3000	16	1,6	375,95
8000134	602266500	SSE 18 LTX	18 V / 2 X 2,0 Ah	0 - 3100	13	1,7	342,99

Sierra de sable



GSA 18V-LI PROFESSIONAL

GSA 18V-28 PROFESSIONAL

GSA 18V-32 PROFESSIONAL

Ref.	Código	Modelo	Nº carreras por minuto c.p.m.	Sierra longitud de la carrera mm	Peso kg	€ / u.
2400569	060164J00B	GSA 18V-LI PROFESSIONAL	0 - 2700	28	2.9	559,00
2400570	06016C0001	GSA 18V-28 Professional	0 - 2700	28	3.2	415,00
2400571	06016A8108	GSA 18V-32 Professional	0 - 2700	32	3.5	479,00

Sierra de sable



CR18DBLWJ

CR12DA

Ref.	Código	Tensión V	Compatible con MV	Brushless	Num. Carreras/min	Mov. De la hoja	Capacidad madera mm	Capacidad acero mm	Capacidad tubo mm	L VH	Batería Ah	Peso Kg	€ / u.
21049067	CR18DBLWJ	18	si	si	0-2.000	orbital	120	19	130	si	5.0	3.4	699,37
21049068	CR12DA	12 PEAK (10,8V)			3.200	13	50	12	50		2.5	1.4	378,01

Sierra de calar



GST 18V-LI B PROFESSIONAL

GST 18V-155 BC PROFESSIONAL

GST 18V-LI B

Ref.	Código	Modelo	Nº carreras por minuto c.p.m.	Cortes angulares	Peso kg	€ / u.
2400572	06015A6106	GST 18V-LI B PROFESSIONAL	0 - 2.700	0-45	1.8	519,00
2400573	06015B1002	GST 18V-155 BC PROFESSIONAL	0 - 3.800	0-45	2	655,00
8000135	06015A6100	GST 18V-LI B	0 - 2.700	0-45	2.4	289,00

Sierra de calar

HIKOKI



Ref.	Código	Tensión V	Compatible con MV	Brushless	Capacidad madera mm	Capacidad acero mm	Capacidad tubo mm	Num. Carreras/min	Mov. Hoja	Peso Kg	€ / u.
21049066	CJ36DAW2	36	si	si	160	10	25	800-3.500	Orbital	2	421,27

Sierra de calar

Makita



Ref.	Código	Tensión V	Capacidad máx. en madera 90° mm	Capacidad máx. en metal 90° mm	Carreras por minuto c.p.m.	Longitud de carrera mm	Capacidad máx. en aluminio 90° mm	Peso kg	€ / u.
213745	DJV182RMJ	18 [4,0Ah]	135	10	800 - 3.500	26	20	2,6	659,00

Sierra de calar

metabo



STA 18 LTX 100 (carcasa)



STAB 18 LTX 100 (carcasa)

Ref.	Código	Modelo	Tensión V / Ah	N° carreras por minuto	Profundidad de corte madera mm	Profundidad max corte acero mm	Profundidad max en Metal NF mm	Peso Kg	€ / u.
20044481	601002840	STA 18 LTX 100 (carcasa)	18 V / sin baterías ni cargador	550 - 2800	100	10	25	2,5 con batería	271,92
20044486	601003840	STAB 18 LTX 100 (carcasa)	18 V / sin baterías ni cargador	550 - 2800	100	10	25	2,5 con batería	271,92

Cepillo

BOSCH



GHO 12V-20 PROFESSIONAL



GHO 12V-20 PROFESSIONAL



GHO 18V-LI PROFESSIONAL

Ref.	Código	Modelo	N° revoluciones máx. r.p.m.	Profundidad rebaje ajustable mm	Anchura de cepillado mm	Peso kg	€ / u.
8000078	06015A7000	GHO 12V-20 PROFESSIONAL	14.500	0 a 17	56	1,5	315,00
20014818	06015A7001	GHO 12V-20 PROFESSIONAL	14.500	0 a 17	56	1,5	479,00
2400574	06015A0300	GHO 18V-LI PROFESSIONAL	14.000	0 a 8	82	1,5	309,00

Cepillo



Ref.	Código	Modelo	Tensión V / Ah	Profundidad rebaje ajustable mm	Revoluciones min.	Peso Kg	€ / u.
21080023	602082840	HO 18 LTX 20-82 (carcasa)	18V / sin baterías, sin cargador	0 - 2,3	16.000	3,5 con batería	293,55

Dobladora/cortadora de varillas



Ref.	Código	Tensión V	Compatible con MV	Brushless	Capacidad corte Varilla Ø10 mm	Capacidad corte de varilla Ø13 mm	Capacidad corte de varilla Ø16 mm	Cap. Curvado varilla Ø10	Cap. Curvado varilla Ø13	Cap. Curvado varilla Ø16	Modo curvado	Peso Kg	€ / u.
21049073	VB3616DAW2	36	si	si	Hasta 2 simultáneamente	1	1	Hasta 3 simultáneamente	Hasta 2 simultáneamente	1	Manual/Automático	18,7	3.150,77

Roedora



Ref.	Código	Tensión V	Cap. acero de 600 N/mm	Cap. aluminio de 200 N/mm	Carreras por minuto c.p.m.	Cap. acero de 400 N/mm	Radio mín. de corte interior mm	Radio mín. de corte exterior mm	Peso kg	€ / u.
213748	DJN161RMJ	18 (4,0Ah)	1,2	2,5	1.900	1,6	45	50	2,2	755,00

Roedora



Ref.	Código	Modelo	Tensión V / Ah	Cap. Acero de 600 N/mm2	Cap. Acero de 400 N/mm2	Velocidad de corte m/min	Peso Kg	€ / u.
20042429	601614840	NIV 18 LTX BL 1.6 (carcasa)	18V / sin baterías, sin cargador	1.2	1.6	2.6	1,25 con batería	592,25

Decapador



Ref.	Código	Modelo	Tensión V / Ah	Caudal de aire l/min	Maletín	€ / u.
20044111	610502840	HG 18 LTX 500	18V / sin baterías, sin cargador	300 / 500	SI	248,23

Remachadora Li-Ion 14,4V



Accubird



Firebird



Birdie

Ref.	Código	Modelo	Carrera de la herramienta mm	Fuerza de tracción N	Rendimiento por carga de batería mm	Peso kg (incl.bat.)	€ / u.
210500	1434898	Accubird	20	10.000	Hasta 1.500 remaches de 2,4	2	812,05
210502	1457414	Firebird	5,5	13.000	Hasta 480 tuercas de M3	2.1	1.134,65
2400575	1746720	Birdie	25	10.000	Hasta 3.000 remaches de 3,2		798,80

Remachadora Li-Ion Bird Pro CAS 18V



Accubird Pro: Hasta Ø 6 mm en cualquier material y Ø 6,4 Aluminio. BULB-TITE 6,3 mm. 4 veces más rápida que Accubird. Powerbird Pro Gold Edition: Hasta Ø 6,4 mm en cualquier material y Ø 8 Aluminio. BULB-TITE 7,7 mm. Firebird Pro: Hasta M8 en Acero y M10 Aluminio. Ajuste sencillo por fuerza digital. Firebird Pro Gold Edition: Hasta M10 en cualquier material y M12 Acero. Ajuste sencillo por fuerza digital. Firebird Pro S Edition: Hasta M10 en cualquier material y M12 Acero. Ajuste por carrera.



Accubird Pro

Powerbird Pro Gold

Firebird Pro

Firebird Pro Gold

Firebird Pro S Gold

Ref.	Código	Modelo	Carrera de la herramienta mm	Fuerza de tracción N	Rendimiento por carga de batería mm	Peso kg (incl.bat.)	€ / u.
2400576	1679661	Accubird Pro	25	13.000	Hasta 1000 remaches de 5,0	2.1	1.023,40
2400577	1679666	Powerbird Pro Gold	25	20.000	Hasta 1600 remaches de 5,0	2.1	1.162,45
2400578	1679670	Firebird Pro	25	15.000	Hasta 900 tuercas M6	2.4	1.295,95
2400579	1679674	Firebird Pro Gold	25	20.000	Hasta 900 tuercas M6	2.4	1.462,80
2400580	1679678	Firebird Pro S Gold	25	20.000	Hasta 900 tuercas M6	2.4	1.490,60

Remachadora para tuercas remachables



Ref.	Código	Modelo	Máx. tuercas remachables en ciego en aluminio:	Máx. tuercas remachables en ciego en acero:	Fuerza de ajuste	€/ u.
2400581	601788840	NMP 18 LTX BL M10 (Carcasa)	M 10	M 8	15.000	1.443,03

Remachadora



TAURUS 1: Hasta \varnothing 4 mm en aluminio/acero. TAURUS 2: Hasta \varnothing 5 mm en todos los materiales y \varnothing 6 mm en aluminio/acero. TAURUS 3: Hasta \varnothing 6,4 mm en todos los materiales y \varnothing 8 mm en aluminio. TAURUS 4: Hasta \varnothing 5 mm en todos los materiales y \varnothing 6 mm en aluminio/acero. FIREFOX 1: Tuercas remachables desde M3 hasta M6 en todos los materiales. Tuercas macho hasta M6. Ajuste por fuerza de tracción. FIREFOX 2: Tuercas remachables desde M3 hasta M12 en todas en los materiales. Tuercas macho hasta M8. Opción de ajuste tanto por carrera como por fuerza de tracción.



TAURUS 1, 2, 3, 4



FIREFOX 2 M4-M8

Ref.	Código	Carrera de la herramienta mm	Consumo de aire	Fuerza de tracción N [a 6 bar]	Presión de trabajo bar	Peso kg	€/ u.
211410	TAURUS 1	15	1,00 l / remache	5.000	5-7	1,3	880,20
211403	TAURUS 2	18	2,3 l / remache	10.800	5-7	1,6	880,20
211404	TAURUS 3	25	4,8 l / remache	16.800	5-7	1,9	1.123,20
211411	TAURUS 4	19	4,8 l / remache	24.000	5-7	2	1.182,60
211414	FIREFOX 2 M4-M8	Ajustable hasta 10 mm	2,0-4,0 l / tuerca	ajustable, máx: 22.000	5-7	2,4	1.895,00

Remachadora para remaches



Remachadora profesional a batería para remaches de 2,4 a 6,5 mm de diámetro en cualquier material, o hasta 7,8 para remaches estándar o S-Trébol de aluminio. Fiable y robusta, esta remachadora de gran potencia confiere alta velocidad en los trabajos más exigentes. Disponible de manera opcional batería de 5 Ah.



Ref.	Código	Modelo	Carrera mm	Fuerza tracción N	Campo de aplicación	Potencia Batería	€/ u.
2400582	02BT20010	BT-20	25 mm.	19.600	Remaches de 2,4 hasta 6,5 mm, y 7,8 S-Trébol.	2,5 Ah - 18V	925,00

Remachadora para remaches



Ref.	Código	Modelo	Tensión V / Ah	Ø remache todos los materiales mm	Ø max remache aluminio mm	Fuerza de ajuste Nm	Rendimiento por carga de batería	€/ u.
21080022	619002840	NP 18 LTX BL 5.0 (carcasa)	18 V / sin baterías ni cargador	2,4 - 5,0	6	10.000	hasta 2.000 remaches de 5.0 mm	719,97

Clavadora



Ref.	Código	Modelo	Tensión V / Ah	tipo de clavo	Longitud de clavos	Peso Kg	€/ u.
2400583	612090800	NFR 18 LTX 90 BL	18V / 2 x 4 Ah LiHD	30 - 34 °	50 - 90 mm	4.7	824,00

Clavadoras y Grapadoras



Para Pins



Para grapas

Ref.	Código	Descripción	Tensión V	Compatible con MV	Brushless	Modo disparo	Sistema de accionamiento	Long. clavo mm	Diám. Clavo	Velocidad disparo	Carga	Batería Ah	Peso Kg	€/ u.
21049070	NT1865DAW6Z	Para clavos	18	si	si	Secuencial/por contacto	Resorte neumático	25-65	1,4 -1,65 mm	3 clavos/seg	Aprox. 1500	3.0	3.4	655,08
21049071	NP18DSALW4	Para Pins	18	si	si	0.6	15 a 35	100					1.66	392,43
21049072	N18DSLW4	Para grapas	18	si		6, 10 y 13	150	Unico/ Continuo					1.14	283,25

Limpiadora de alta presión H&G



Hidrolimpiadora H&G



K 5 FC



K 7 FC



K 7 PREMIUM FC HOME T 450

Ref.	Código	Modelo	Potencia kW	Presión máx. bar	Caudal l/h	€ / u.
200115	1.324-550.0	K 5 FC	2.1	145	500	365,00
200116	1.317-200.0	K 7 FC	3	180	600	560,00
200117	1.317-203.0	K 7 PREMIUM FC HOME T 450	3	180	600	615,00

Limpiadora de alta presión agua fría Profesional



Hidrolimpiadora Prof



HD 5/15 C



HD 6/15 M



HD 10/25 4S



HD 6/15 G

Ref.	Código	Modelo	Potencia kW	Presión Trabajo bares	Caudal l/h	€ / u.
200125	1.520-930.0	HD 5/15 C	2.8	150	500	950,00
200126	1.150-930.0	HD 6/15 M	3.1	150	560	1.260,00
200129	1.286-954.0	HD 10/25 4S	9.2	250	1.000	2.995,00
200130	1.187-010.0	HD 6/15 G	Gasolina 4,1	150	600	1.025,00
200131	1.187-013.0	HD 8/23 G	Gasolina 6,8	230	800	1.650,00

Hidrolimpiadora PW



IDAF94231



IDAF40914



IDAF40926

Ref.	Código	Potencia kW	Presión bar	Caudal l/h	Temp. Max °C	r.p.m	Conex. Eléctrica	€ / u.
8000352	IDAF94231	3	160	600	50	2.800	230V-50Hz	870,00
8000354	IDAF40914	3.2	170	500	50	1.400	230V-50Hz	1.710,00
8000355	IDAF40926	6.4	210	1.000	50	1.400	3Ph-400V-50Hz	2.420,00

Limpiadora de alta presión agua caliente Profesional



HDS 5/15 U



HDS 6/14 C



HDS 7/16 4C



HDS 10/20 4M

Ref.	Código	Modelo	Potencia kW	Caudal l/h	Presión Trabajo bares	Temperatura de trabajo °C	€/ u.
200135	1.064-912.0	HDS 5/15 U	2.7	450	150	80	2.495,00
200136	1.169-900.0	HDS 6/14 C	3.6	560	140	80-155	3.695,00
200137	1.174-904.0	HDS 7/16 4C	5.1	700	160	80	3.495,00
21061000	1.071-939.0	HDS 10/20 4M	7.8	1.000	200	80-155	5.675,00

Hidrolimpiadora de agua caliente



Incluye manguera, pistola, lanza, inyector y 1kg de antical.



Ref.	Código	Potencia kW	Caudal l/h	Caudal l/h	Motor rpm	Potencia térmica caldera	Presión bar	Temperatura Max °C	€/ u.
2400584	IDAC41367	6.4	500-1000	500-1000	1.400	>=70 kW	200	30-110	4.900,00

Hidrolimpiadora autónomas de agua fría



Incluye manguera, pistola, lanza e inyector.



Ref.	Código	Potencia HP	Presión bar	Caudal l/h	Temp. Max	r.p.m	Motor	€/ u.
2400585	IDAF41151	6.5	180	330-660	50 °C	3.600	Gasolina	2.511,11

Barredora profesional de hombre a pie



Ref.	Código	Ancho de trabajo cepillo principal mm	Ancho de trabajo cepillo lateral	Rendimiento teórico máx.	Capacidad depósito l	Velocidad máx.	Pendiente máx.	€/ u.
2400586	MSUT00645	490	670 mm	2345 m ² /h	24	3,5 km/h	0.02	718,48

Barredora Profesional



Ref.	Código	Modelo	Capacidad l	Ancho de barrido mm	Rendimiento m2/h	€ / u.
200150	1.517-213.0	KM 70/15 C	42	700	2.800	2.125,00

Pulidora Profesional



Ref.	Código	Modelo	Ancho de fregado mm	Tensión V	€ / u.
21061004	1.291-243.0	BDS 43/180 C ADV***	430	220	865,00

Limpiadora de alta presión agua fría Profesional



Ref.	Código	Caudal l/h	Motor	COMBUSTIBLE	Presión Trabajo bares	Dimensiones mm	Peso kg.	€ / u.
21134027	NA2400H1000	12.5	Honda GX390	Gasolina	240	951x765x655	64	2.200,00

Fregadora automática



BR 40/10 C ADV



BD 43/35 C EP*



BD 43/25 C BP**

Ref.	Código	Modelo	Capacidad l	Ancho de fregado mm	Rendimiento m2/h	Tensión V	€ / u.
200155	1.783-311.0	BR 40/10 C ADV	10/10	400	400	220	2.905,00
200156	1.515-401.0	BD 43/35 C EP*	35/35	430	2.000	220	2.895,00
21061003	1.127-001.0	BD 43/25 C BP**	35/25	430	2.000	24	2.995,00

Fregadora hombre a pie Profesional



LPTE00531



LPTB01520

Ref.	Código	Ancho boquilla cm	Ancho cepillo cm	Batería/ Tensión	Dep. agua limpia l	Dep. recuperación l	Rendimiento km/h	€/ u.
700315	LPTE00531	1.670	45	55	28	28	1-230-50	3.149,16
700316	LPTB01520	1.750	50	73	40	45	2x12V	5.100,00

Fregadora hombre a pie



Ref.	Código	Rendimiento	Ancho cepillo cm	Ancho boquilla cm	Dep. agua limpia l	Dep. recuperación l	Batería/Tensión	€/ u.
8000350	LPTB03027	2475 m2/hora	55	82	50	53	2x12V (105Ah)	7.900,00

Fregadora de conductor



Ref.	Código	Rendimiento	Ancho cepillo cm	Ancho boquilla cm	Dep. agua limpia l	Dep. recuperación l	Batería/Tensión	€/ u.
8000351	LPTB02720	4068 m2/hora	55	71	80	83	2x12V (105Ah)	11.847,81

Aspirador polvo-agua H&G



WD 4



WD 5



WD 6 PREMIUM

Ref.	Código	Modelo	Capacidad l	Potencia Max W	€ / u.
200120	1.628-209.0	WD 4	20	1.000	130,00
200121	1.628-300.0	WD 5	25	1.100	175,00
200122	1.628-360.0	WD 6 PREMIUM	30	1.300	250,00

Aspirador polvo agua



AS 20 L PC



ASA 20 L PC



ASA 30 L PC

Ref.	Código	Modelo	Potencia W	Capacidad Litros	€ / u.
2400587	602083000	AS 20 L PC	1.200	20	180,00
2400588	602085000	ASA 20 L PC	1.200	20	220,00
2400589	602086000	ASA 30 L PC	1.200	30	260,00

Aspirador a batería



AS 18 L PC (carcasa)



AS 18 L PC Compact (carcasa)



AS 18 HEPA PC Compact (carcasa)

Ref.	Código	Modelo	Tensión V / Ah	Max Caudal de aire l/min	Capacidad depósito L	Depresión mbar	Peso Kg	€ / u.
21080026	602021850	AS 18 L PC (carcasa)	18V / sin baterías, sin cargador	2.100	7,5	120	7,4 con batería	293,55
21080027	602028850	AS 18 L PC Compact (carcasa)	18V / sin baterías, sin cargador	2.100	6	120	4,8 con batería	159,65
21080028	602029850	AS 18 HEPA PC Compact (carcasa)	18V / sin baterías, sin cargador	2.100	6	120	4,8 con batería	178,19

Aspirador



Práctico gancho portacable. Ganchos Robustos. Dispositivo integrado para detener los líquidos y la espuma, protegiendo el motor



SASD012046 SASD012042 SASD012018 SASD012001 SASD012037

Ref.	Código	Capacidad depósito l	Caudal de aire m3/h	Depresión mm H2O	Motor W	Voltaje V	€ / u.
216231	SASD012046	33	200	2.380	1.300	230	378,19
216232	SASD012042	41	200	2.380	1.300	230	347,66
216233	SASD012018	62	400	2.380	2 2.600	230	392,52
216234	SASD012001	62	600	2.380	3 3.600	230	591,81
216235	SASD012037	37	220	2.400	1.400	230	796,27

Aspirador polvo-agua Profesional



NT 22/1 AP NT 35/1 NT 30/1 Tact L NT 75/2 AP ME NT 90/2 NT 65/2 AP

Ref.	Código	Modelo	Potencia kW	Vacio mbar	Capacidad l	Caudal l/seg	€ / u.
200141	1.378-600.0	NT 22/1 AP	1.350	255	22	71	240,00
21061001	1.148-221.0	NT 35/1	1.380	254	35	74	455,00
21061002	1.148-211.0	NT 30/1 Tact L	1.380	254	30	74	740,00
200144	1.667-292.0	NT 75/2 AP ME	2.760	254	75	2x74	1.400,00
200145	1.667-700.0	NT 90/2	2.300	225	90	3x53	925,00
200146	1.667-291.0	NT 65/2 AP	2.760	254	65	2x74	1.445,00

Pulverizador IK MULTI



Especialmente fabricado con materiales de máxima resistencia, juntas y materiales resistentes a la mayoría de ácidos y disolventes, para ser compatibles con agentes químicos de uso general en el mundo de la limpieza y desinfección profesional, la construcción, la automoción y todo tipo de talleres industriales.

Ref.	Código	Modelo	Capacidad útil l	€ / u.
1100155	81771	IK MULTI - 1,5	1	19,53
1100156	83811901	IK MULTI - 6	4,5	72,19
1100157	83811911	IK MULTI - 9	6	77,15
1100158	83811921	IK MULTI - 12	9	84,10
1100159	839701	IK MULTI - 12 BS	12	89,04



Pulverizador IK HC 1,5



Especialmente fabricado con materiales de máxima resistencia, con juntas y materiales resistente a aceites y a la mayoría de los hidrocarburos, lubricantes y derivados de petróleo en aplicaciones como: limpieza de frenos, eliminación de manchas de alquitrán en carrocerías y herramientas, desengrasado,...
NO ACIDS



Ref.	Código	Modelo	Capacidad útil l	€/ u.
1100160	81774	IK HC 1,5 (Hidrocarburos)	1	19,53

Pulverizador



Ref.	Código	Modelo	Capacidad útil l	APLICACIÓN ph	JUNTAS	APLICACIÓN ph	€/ u.
21056011	3111P	3111P	1	1-9	FPM	1-9	5,16
21056012	3111PD	3111PD - E	1	7-14	EDPM	7-14	5,16



Pulverizador a presión



Uso Industrial

Ref.	Código	Modelo	Capacidad útil l	APLICACIÓN ph	JUNTAS	APLICACIÓN ph	€/ u.
21056013	3132PG	PLUS 1,5L	1,5	4-7	FPM	4-7	18,54



Pulverizador a presión de 3 bares



Uso Industrial

Ref.	Código	Modelo	Capacidad útil l	JUNTAS	PRESION bar	JUNTAS	€/ u.
21056014	3237P	5L. 3237P	5	FPM	3	FPM	58,73



Pulverizador ALKALINE



Pulverizadores especialmente fabricados con materiales de máxima resistencia para ser compatibles con agentes químicos del mundo de la limpieza y la desinfección. Especialmente indicados para las sustancias alcalinas, alcoholes y acetonas.

Ref.	Código	Modelo	Capacidad útil l	€/ u.
1100165	81777	IK ALKALINE 1,5	1	19,92
1100166	83811916	IK ALKALINE 9	6	78,73



Pulverizador EVOLUTION 16



Pulverizador de espalda a presión retenida, con retén de vitón. Lanza de fibra de vidrio de 0,95 m. con nueva maneta de acero inoxidable. Depósito resistente y ligero de polipropileno, con indicador de nivel translúcido natural. Asa de transporte integrada y ergonómica. Fácil mantenimiento sin herramientas. Incluye regulador de presión y juego de boquillas de serie.

Ref.	Código	Modelo	Capacidad útil l	€ / u.
1100175	84941	EVOLUTION 16	16	68,05



Pulverizador mochila



Uso Agrícola

Ref.	Código	Capacidad útil l	PRESION bar	JUNTAS	€ / u.
21056015	RS120	12	6	FPM	152,26



Pulverizador IK MULTI TR MINI 360°



Pulverizador Mini de gatillo, ligero y manejable, para trabajos de limpieza y desinfección en superficies de tamaño reducido. Tiene un sistema 360° para pulverizar en todas las posiciones. Óptimo para desinfectantes, productos neutros, alcoholes, alcalinos y cetonas.

Ref.	Código	Modelo	Capacidad útil l	€ / u.
2400590	84173	IK MULTI TR MINI 360°	0.6	10,52



Pulverizador IK MULTI TR 1



Pulverizador de gatillo diseñado para uso profesional en la limpieza y desinfección de superficies y áreas infectadas. Seguro y fácil de usar. Óptimo: desinfectantes, productos neutros, alcoholes, alcalinos y cetonas. Apto: ácidos diluidos.

Ref.	Código	Modelo	Capacidad útil l	€ / u.
2400591	84170	IK MULTI TR 1	1	9,56



Pulverizador IK MULTI PRO



Diseñado para uso profesional con los químicos más agresivos de diversos sectores. Especialmente resistente a ácidos. Depósito translúcido con indicador de nivel. Base para mayor estabilidad. Amplia boca de llenado. Bloqueo de seguridad. Válvula de seguridad despresurizable. Posibilidad de identificar contenido mediante tapas de colores.

Ref.	Código	Modelo	Capacidad útil l	€ / u.
2400592	81671	IK MULTI PRO 2	1.5	21,26
2400593	82672	IK MULTI PRO 9	6	84,02
2400594	82671	IK MULTI PRO 12	9	91,59



Pulverizador IK HC TR 1



Pulverizador de gatillo, especialmente fabricado con materiales de máxima resistencia para ser utilizado en el mundo de la limpieza profesional y la desinfección, la automoción y los trabajos industriales. Óptimo: Productos en base solvente, aceites y derivados del petróleo, alcoholes. Apto: Alcalinos y Cetonas.

Ref.	Código	Modelo	Capacidad útil l	€ / u.
2400595	84174	IK HC TR 1	1	9,67



Pulverizador IK FOAM PRO 2



Pulverizadores específicamente fabricados para la generación de espuma seca y duradera. Diseñados para ser empleados con agentes químicos con propiedades surfactantes (tensoactivos). Base estable. Depósito translúcido con indicador de nivel. Bloqueo de seguridad. Valvula de seguridad despresurizable. Posibilidad de identificar contenido mediante tapas de colores.

Ref.	Código	Modelo	Capacidad útil l	€ / u.
2400596	81676	IK FOAM PRO 2	1.5	26,28



Llave de impacto



Ref.	Código	Apriete Nm	Capacidad	Consumo l/h	Cuadradillo	Entrada de aire	Longitud mm	Ø Manguera mm	Peso kg	€ / u.
210700	136	140	M 10	280	3/8	1/4	175	8	1,0	90,00
210702	138PH	270	M 10	280	3/8	1/4	140	8	1,4	218,35
210715	140PH	330	M 12	300	1/2	1/4	153	10	1,1	225,00

Llave de impacto



Ref.	Código	Apriete Nm	Capacidad	Consumo l/h	Cuadradillo	Entrada de aire	Longitud mm	Ø Manguera mm	Peso kg	€ / u.
210704	155PHK	550	M 16	300	1/2	1/4	186	10	2,7	325,40

Llave de impacto



Ref.	Código	Apriete Nm	Capacidad	Consumo l/h	Cuadrado	Entrada de aire	Longitud mm	Ø Manguera mm	Peso kg	€/ u.
210713	245AC	220	M13	400	1/2	1/4	341	10	1,6	425,00
210712	139PH	390	M16	300	1/2	1/4	122	10	1,5	209,70
21007000	167PH	560	M 16	139	1/2	1/4	120	10	1,2	171,30
210711	129PH	670	M16	480	1/2	1/4	97	10	1,7	293,25
210705	161PH	680	M 19	400	1/2	1/4	178	10	2,1	298,00
210716	165PH	780	M19	400	1/2	1/4	183	10	1,9	249,00
210706	170P	810	M 21	400	3/4	1/4	217	10	3,0	368,90
210714	160PH	950	M19	400	1/2	1/4	217	10	3	330,65
210707	220P	1.030	M 25	400	3/4	1/4	230	10	4,8	484,60
210717	265PH	1.650	M27	650	3/4	3/8	215	13	3,3	599,90
210708	BIG-322P	2.500	M 38	770	1	3/8	265	13	9,5	1.006,95
210709	BIG-322P-8	2.500	M 38	770	1	3/8	430	13	10,4	1.050,65
210710	BIG-322SA	2.500	M 38	770	1	3/8	515	13	11,0	1.050,65

Llave de impacto



Mini Llave Cuerpo metálico, cuadradillo 1/2"



Ref.	Código	Descripción	Apriete máx. Nm	Capacidad	Sistema de Impacto	Utilización	Velocidad r.p.m.	Peso kg	€/ u.
21132000	YAH110C	Mini llave angular 1/2"	650	M-12	Maza simple	Continuada	7.500	1,4	240,00
216244	YAH120	Cuerpo metálico, cuadradillo 1/2"	680	M-18	Doble Maza	Continuada	7.000	2,7	150,00
216236	YAH111	Mini Llave Cuerpo metálico, cuad. 1/2"	750	M-16	Maza Simple	Continuada	10.000	1,35	229,00
8000140	YAH123	Mini llave cuerpo composite 1/2"	900	M-18	Doble Maza	Intensa	9.000	1,2	225,00
21132001	YAH114	Mini llave cuerpo metálico 1/2"	950	M-18	Doble Maza	Intensa	10.000	1,5	236,00
21132002	YAH125N	Cuerpo composite, cuadradillo 1/2"	950	M-18	Doble Maza	Continuada	10.000	2,05	202,00
216246	YAH231	Cuerpo metálico, cuadradillo 3/4"	1.250	M-25	Doble Maza	Continuada	4.500	4,6	315,00
216247	YAH250	Cuerpo composite, cuadradillo 3/4"	1.475	M-25	Doble Maza	Continuada	6.200	4,4	439,00
8000141	YAH130	Muy potente cuerpo composite 1/2"	1.500	M-24	Doble Maza	Intensa	8.500	1,65	311,00
21132003	YAH351N	Muy potente. Cuerpo composite, cuadradillo 3/4"	1.850	M-27	Doble Maza	Intensa	5.500	3,73	575,00
216250	YAH453L	Cuerpo metálico, cuadradillo 1" cuello 150 mm.	2.350	M-33	Martillo simple	Continuada	4.000	11,8	630,00
8000142	YAH435L	Serie Ligera y ergonómica 1". cUELLO 180 mm	2.445	M-33	Doble Maza	Intensa	6.000	7,3	887,00
216249	YAH452	Cuerpo metálico, cuadradillo 1"	2.450	M-33	Martillo simple	Continuada	4.000	9,95	600,00
21132004	YAH552L	Serie Ligera, muy potente 1" cuello de 150 mm	2.900	M-36	Doble Maza	Intensa	5.500	6,6	1.064,00
21132005	YAH553	Serie Ligera, muy potente 1"	2.990	M-36	Doble Maza	Intensa	5.500	6,2	1.001,00
216251	YAH65	Muy potente. Cuerpo metálico, cuadradillo 1" 1/2	4.100	M-50	Doble Maza	Intensa	3.000	15	2.160,00

Llave de impacto



Ref.	Código	Par máx. apriete Nm	Consumo máx. aire l	Cuadradillo	Entrada de aire	Ø Manguera mm	Peso kg	Presión bar	Velocidad r.p.m.	€/ u.
216262	BP901	3.500	460	1"	1/2"	13	11,9 kg	6,2	3.800	986,99
216263	BP901L	3.500	460	1"	1/2"	13	13,3 kg	6,2	3.800	1.000,05
216264	BP905P	2.440	282	1"	1/2"	13	6,3 kg	6,2	6.000	1.300,73

Carraca



BP700



BP820



BP821

Ref.	Código	Apriete Nm	Consumo de aire l	Cuadradillo	Entrada de aire	Ø Manguera mm	Peso kg	Presión bar	r.p.m	€/ u.
216270	BP700	0-30	65	1/4"	1/4"	10	0,5	6,3	300	204,10
216271	BP820	0-67	120	3/8"	1/4"	10	1,2	6,3	270	217,66
216272	BP821	0-67	120	1/2"	1/4"	10	1,2	6,3	150	255,28

Carraca



760



762



738



133



C5004



132



175

Ref.	Código	Apriete Nm	Capacidad	Consumo l/h	Cuadradillo	Entrada de aire	Ø Manguera mm	Peso kg	r.p.m	€/ u.
210800	760	40	M 8	160	1/4	1/4	8	0,5	230	121,40
210801	762	40	M 10	170	1/4	1/4	8	0,7	250	255,80
210806	738	68	M 10	170	3/8	1/4	8	0,7	350	230,80
210805	133	80	M 12	200	1/2	1/4	8	1,2	180	118,55
2400597	C5004	80	M-12	368	1/2"	1/4"	8	1,3	160	106,00
2400598	C5003	82	M-12	368	3/8"	1/4"	8	1,3	160	112,50
210803	132	122	M 12	200	1/2	1/4	8	1,5	180	319,20
210804	175	110	M 12	200	1/2	1/4	8	1,6	250	218,90

Carraca



YA855



YA8550



YA8581



YA8580N



YAH879



YA7777

Ref.	Código	Apriete máx. Nm	Capacidad	Descripción	Sistema	Utilización	Velocidad r.p.m.	Peso kg	€/ u.
216280	YA855	30	M-8	Cuadradillo 1/4"	Trinquete	Intermitente	230	0,5	89,00
8000143	YA8550	50	M-8	Mini carraca, cabezal reforzado. Cuadradillo 1/4"	Blindado	Continuada	300	0,5	142,00
216281	YA8581	70	M-12	Cuadradillo 1/2"	Trinquete	Intermitente	160	1,2	105,00
216282	YA8580N	80	M-12	Cuadradillo 1/2"	Doble Trinquete	Continuada	180	1,2	119,00
216285	YA7777	120	M-12	Cuadradillo 1/2"	Doble Trinquete	Intensa	180	1,5	312,00
216284	YAH879	140	M-14	Maza Simple Cuadradillo 1/2"	Impacto	Continuada	600	1,45	338,00

Atornillador de doble impacto



Ref.	Código	Par Nm	Capacidad	Consumo l/h	Entrada de aire	Longitud mm	Ø Manguera mm	Peso kg	Regulador exterior	€/ u.
210901	GT-PLP	7	M 5	200	1/4	197	8	0,7	NO	760,80
210903	6SSLD	18	M 6	300	1/4	202	8	1,0	NO	537,60
210904	6SLD	18	M 6	300	1/4	175	8	1,2	NO	536,80
210910	8SLD	270	M10	300	1/4	155	8	1,3	NO	251,90
210911	8SSLD	230	M10	300	1/4	220	8	1,3	NO	257,90

Atornillador de embrague



Ref.	Código	Apriete Nm	Capacidad	Consumo l/h	Longitud mm	Ø Manguera mm	Peso kg	r.p.m	Regulador	€/ u.
211106	404A	3 - 8	M 3 - 6	300	205	8	1,2	1.800	Interior	119,40
211107	404-8	4 - 11	M 3 - 8	300	216	8	1,3	800	Interior	147,30
211117	822	3 - 8	M 3 - 6	300	240	8	1,1	1.800	Exterior	207,90
211121	842	3 - 8	M 3 - 6	300	203	8	1,2	1.800	Exterior	181,10
211122	843	4 - 11	M 3 - 8	300	216	8	1,3	800	Exterior	196,70
211108	852	3 - 8	M 3 - 6	300	203	8	1,2	1.800	Exterior	222,50
211109	853	4 - 11	M 3 - 8	300	216	8	1,3	800	Exterior	243,40
211110	862	3 - 8	M 3 - 6	300	240	8	1,1	1.800	Exterior	236,50
211111	863	4 - 11	M 3 - 8	300	255	8	1,2	800	Exterior	257,90
211113	CCP-48	1 - 6	M 3 - 6	500	165	8	0,8	1.700	Exterior	314,95
211112	CCP-58	1 - 9	M 3 - 8	500	165	8	0,8	750	Exterior	314,95
211115	CS-48	1 - 6	M 3 - 6	500	206	8	0,8	1.700	Exterior	290,65
211116	CS-58	1 - 9	M 3 - 8	500	206	8	0,8	750	Exterior	290,65

Atornillador de pistola con embrague, reversible



Cuerpo composite, conexión puntas 1/4"



Ref.	Código	Apriete Nm	Descripción	Capacidad	Embrague con regulación exterior	Utilización	Velocidad r.p.m.	Peso kg	€ / u.
216289	YA8063N	4 - 11	Cuerpo composite, conexión puntas 1/4"	M-8	Deslizante	Intermitente	800	1,2	195,00
216291	YACCP45	0,5 - 6	Conexión puntas 1/4"	M-6	Deslizante	Continuada	750	0,6	304,00
216292	YACCP58	1 - 9	Conexión puntas 1/4"	M-8	Deslizante	Continuada	750	0,8	315,00
216293	YACPP41	0,5 - 3,5	Conexión puntas 1/4"	M-5	Desconexión	Continuada	1.000	0,6	720,00
216294	YACPP50	1 - 6	Conexión puntas 1/4"	M-7	Desconexión	Continuada	1.400	0,9	720,00
216295	YACPP65	3 - 18	Conexión puntas 1/4"	M-9	Desconexión	Continuada	300	1,1	783,00
216296	YACWP55	1,2 - 7,5	Cuadradillo 3/8"	M-7	Desconexión	Continuada	1.000	0,9	722,00
216297	YACWP65	3 - 18	Cuadradillo 3/8"	M-9	Desconexión	Continuada	300	1,1	786,00

Atornillador recto y angular con embrague, reversible



Cuerpo con funda elastomer.



Ref.	Código	Descripción	Apriete Nm	Capacidad	Embrague con regulación exterior	Utilización	Velocidad r.p.m.	Peso kg	€ / u.
216300	YACS45	Conexión puntas 1/4"	0,5 - 6	M-5	Deslizante	Continuada	750	0,6	282,00
216301	YACS58	Conexión puntas 1/4"	1 - 9	M-8	Deslizante	Continuada	750	0,8	287,00
216302	YACP30	Conexión puntas 1/4"	0,3 - 1,7	M-4	Desconexión	Continuada	1.800	0,4	607,00
216303	YACP45	Conexión puntas 1/4"	0,8 - 4	M-6	Desconexión	Continuada	800	0,4	624,00
216304	YACP55	Conexión puntas 1/4"	0,7 - 6,5	M-7	Desconexión	Continuada	1.000	0,7	646,00
216305	YACP65	Conexión puntas 1/4"	3 - 18	M-9	Desconexión	Continuada	300	0,8	724,00
216306	YACA40	Conexión puntas 1/4"	0,5 - 3	M-5	Desconexión	Intensa	1.000	0,6	891,00
216307	YACA55	Conexión puntas 1/4"	0,7 - 6,5	M-7	Desconexión	Intensa	1.000	1,3	945,00
216308	YACA65	Conexión puntas 1/4"	3 - 18	M-9	Desconexión	Intensa	300	1,3	1.020,00
216309	YACAW55	Cuadradillo 3/8"	0,7 - 6,5	M-7	Desconexión	Intensa	1.000	1,3	982,00
216310	YACAW65	Cuadradillo 3/8"	3 - 18	M-9	Desconexión	Intensa	300	1,3	1.066,00
216311	YACAW75	Cuadradillo 1/2"	5 - 35	M-11	Desconexión	Intensa	250	2,4	2.281,00
21132006	YACAW85	Cuadradillo 1/2"	10 - 55	M-12	Desconexión	Intensa	180	2,45	2.451,00

Atornillador con desconexión



Ref.	Código	Apriete Nm	Capacidad	Consumo l/h	Entrada de aire	Longitud mm	Ø Manguera mm	Peso kg	r.p.m.	€ / u.
211000	ST-44000	0,1 - 1,0	M 1,7 - 3,3	250	1/4	180	8	0,5	1.000	523,95
211001	ST-44002	0,4 - 3,3	M 2,6 - 5	280	1/4	180	8	0,5	1.000	523,95
211002	ST-44004	1,0 - 7,0	M 2,9 - 6,4	550	1/4	215	8	0,8	1.000	550,10
211003	S44004P	1,2 - 7,5	M 3,5 - 6,6	500	1/4	215	8	1,0	1.000	611,40
211004	S44006P	3 - 11	M 5 - 7,3	500	1/4	215	8	1,0	550	621,30
211005	S44008P	3 - 18	M 5 - 9,3	500	1/4	215	8	1,1	300	686,20

Taladro



Ref.	Código	Descripción	Capacidad de broca mm	Rosca del portabrocas	Utilización	Velocidad r.p.m.	Peso kg	€/ u.
214448	YA840R	Cuerpo metálico. Reversible	1 - 10	3/8" - 24	Intermitente	1.800	1,2	97,00
214446	YA8035N	Cuerpo de composite	1 - 10	3/8" - 24	Intermitente	2.600	1,0	125,00
214452	YACDD48	Cuerpo de composite. Reversible	1 - 10	3/8" - 24	Continuada	1.700	0,9	229,00
214455	YA8361	Cuerpo metálico	1,5 - 13	3/8" - 24	Continuada	500	1,8	203,00
214456	YA8386	Cuerpo metálico, gran potencia	1,5 - 16	1/2" - 20	Continuada	800	3,6	1.047,00
214457	YA837	Cuerpo de composite	1 - 10	3/8" - 24	Intermitente	2.600	0,9	125,00
214459	YA8047CR	Funda de plástico, angular 90°. Reversible	1 - 10	3/8" - 24	Continuada	1.400	1,8	178,00
21132007	YA8410	Cuerpo metálico aligerado	1 - 10	3/8" - 24	Intensa	2.600	1,10	399,00

Taladro



Ref.	Código	Capacidad	Consumo l/h	Longitud mm	Ø Manguera mm	Peso kg	Portabrocas	Potencia W	r.p.m	€/ u.
211200	500AH	10	300	195	8	0,9	llave	300	1900	167,15
211201	523DS/K	10	300	190	8	1,1	rápido	300	3.800	213,40
211202	FRD-6PH-3	8	340	164	8	1,1	llave	300	2.800	756,25
211203	FRD-6PH-5	10	340	187	8	1,3	llave	300	1.300	907,50
211204	FRD-6PH-7	13	340	222	10	1,7	llave	300	600	1.086,30
211206	232P	10	300	170	8	1,4	rápido	300	1.800	131,30
211207	233P	13	350	195	8	1,8	rápido	300	800	165,90
211208	520P/K	10	300	165	8	1,0	rápido	300	2.200	198,95
211209	HDD-48	10	400	199	8	0,9	rápido	360	1.700	238,60
211210	HDD-458	13	350	199	8	0,9	rápido	360	750	268,60
211215	600AH	10	300	185	8	1,2	llave	300	1.200	175,50
211216	443PT	10	400	225	8	2,6	llave	300	7.000	359,35



Roscadora



YAQ12950



YAQ16950



YAT241900

Ref.	Código	Descripción	Área de trabajo horizontal mm	Área de trabajo vertical mm	Capacidad	Utilización	Velocidad r.p.m.	€ / u.
214500	YAQ12950	Brazo con roscadora cabecilla serie 1	950	475	M-3 / M-12	Intensa	400	2.312,00
214501	YAQ16950	Brazo con roscadora cabecilla serie 2	950	460	M-3 / M-16	Intensa	300	3.348,00
214503	YAT241900	Brazo con roscadora cabecilla serie 2	1.900	860	M-3/M-24	Intensa	100/300	5.363,00

Roscadora



FT-6BX-1



FT-8PX-1



FT-13Z-1C



120D

Ref.	Código	Potencia W	Acero	Aluminio	Consumo l/h	Longitud mm	Peso kg	r.p.m	Roscadora/eje	€ / u.
211300	FT-6BX-1	300	6	8	400	240	1,5	2.000	JT.1	1.406,85
211301	FT-8PX-1	400	8	10	400	232	2,0	450	MT.2	1.918,25
211302	FT-13Z-1C	400	13	13	400	384	4	400	JT.6	2.796,35
211305	120D	300	12	12	450	350	1,5	360D-720I	MT.2	1.163,50

Roscadora



YARPC12



YARPP12



YARC12

Ref.	Código	Descripción	Capacidad	Utilización	Velocidad r.p.m.	€ / u.
211315	YARPC12	Sujección del macho con cabecilla serie 1	M-3 / M-12	Intensa	250	1.636,00
211316	YARPP12	Sujección del macho con pinza ajustable	M-3 / M-12	Intensa	250	1.564,00
211318	YARC12	Sujección del macho con cabecilla serie 1	M-12	Intensa	400	1.453,00

Remachadora oleo neumática, BNT



Remachadoras profesionales oleo neumáticas gama BNT "novedad". Diseñadas para uso profesional, gran fuerza de remachadora, muy ligeras, bajo nivel de ruido y consumo de aire, el cual se reutiliza para la aspiración del vástago, garantía europea.



02BNT3010



02BNTN010

Ref.	Código	Campo de aplicación	Carrera mm	Fuerza tracción N	Modelo	Peso grs.	Presión de trabajo bar	€ / u.
1200242	02BNT3010	Remaches de 3,0 a 5,0 mm. - 6,0 en Aluminio y Gama Hard Grip hasta 4,8 mm.	17	12.100	BNT-3	1.370	6	595,00
21023006	02BNTN010	Para tuercas remachables M-3 a M-8 en aluminio, acero e inoxidable. M-10 en aluminio y acero	7	17.700	BNT-N	2.1000	6	2.020,00

Lijadora rotorbital



906-5



906D-5



905AD



910



910D

Ref.	Código	Aspiración	Conexión	Consumo l/h	Ø Disco	Ø Manguera mm	Órbita mm	Peso	r.p.m	€ / u.
211502	906-5	NO	1/4	450	150	10	5	0,7	10.000	401,50
211503	906D-5	SI	1/4	450	150	10	5	0,8	10.000	427,80
211504	905AD	SI	1/4	400	150	10	10	1,6	10.000	645,70
211510	910	NO	1/4	450	150	10	5	0,8	11.000	262,70
211511	910D	SI	1/4	450	150	10	5	0,8	11.000	310,40

Lijadora rotorbital



YA715AS



YA726AS



YA9290AS



YA712AS

Ref.	Código	Órbita mm	Plato mm	Utilización	Velocidad r.p.m.	Peso kg	€ / u.
211453	YA715AS	5	150	Intermitente	12.000	0,85	170,00
211450	YA726AS	5	150	Continuada	9.000	1,3	277,00
211451	YA9290AS	5	150	Intensa	12.000	0,8	362,00
211452	YA712AS	2,5	75	Continuada	10.500	0,7	231,00

Lijadora de banda



Ref.	Código	Base cm	Conexión	Consumo l/h	Ø Manguera mm	r.p.m	Peso kg	€/ u.
211600	212A	12 x 330	1/4	350	8	13.000	0,9	656,65
211601	220A	20 x 520	1/4	400	8	12.000	1,4	789,35
211602	7009	10 x 330	1/4	350	8	16.000	0,9	158,40
211603	7010	20 x 520	1/4	400	8	16.000	1,1	268,20

Lijadora orbital



Ref.	Código	Aspiración	Base cm	Conexión	Consumo l/h	Ø Manguera mm	Órbita mm	r.p.m	Peso kg	€/ u.
211700	815	No	74 x 145	1/4	350	10	5	8.000	1,2	212,10
211704	873BL/L	No	74 x 155	1/4	266	10	5	9.000	0,9	557,15
211705	774B	No	73 x 140	1/4	250	10	5	8.000	1,5	305,60
211706	774BD	Si	74 x 145	1/4	350	10	5	8.000	1,3	336,90
211703	812BDV	Si	115 x 222	1/4	400	10	5	6.000	2,6	406,70

Lijadora orbital



Cuerpo con funda de goma, base velcro y con pinzas



Cuerpo con funda de goma, base velcro y con pinzas

Ref.	Código	Base mm	Órbita	Velocidad r.p.m.	Utilización	Peso Kg.	€/ u.
8001552	YA404	75 X 100	3,2	10.000	Continuada	0,7	209,00

Cuerpo composite, base velcro

Ref.	Código	Base mm	Órbita	Velocidad r.p.m.	Utilización	Peso Kg.	€/ u.
8001553	YA707AS	100 X 180	3,2	8.500	Continuada	1,2	314,00

Cuerpo con funda de goma, base velcro

Ref.	Código	Base mm	Órbita	Velocidad r.p.m.	Utilización	Peso Kg.	€/ u.
8001554	YA405	70 X 100	3,2	10.000	Continuada	0,7	229,00

Lijadora angular



YA416



YA4701

Cuerpo composite, Platos cartón

Ref.	Código	Potencia W	Rosca de eje	Capacidad disco mm	Velocidad r.p.m.	Utilización	Peso Kg.	€ / u.
8001549	YA416	300	7/16-20	75,115,125	17.000	Intermitente	0,9	131,00

Regulador de velocidad

Ref.	Código	Potencia W	Rosca de eje	Capacidad disco mm	Velocidad r.p.m.	Utilización	Peso Kg.	€ / u.
8001548	YA4701	950	M-14	178	4.500	Continuada	2,3	355,00

Lijadora angular y vertical



Doble mango. Plato de 178 mm



Ref.	Código	Potencia W	Capacidad disco mm	Velocidad r.p.m.	Utilización	Peso Kg.	€ / u.
8001550	YA821	450	178	4.200	Continuada	2.6	225,00

Lijadora angular y vertical



Cuerpo composite, bloqueo del eje. Para discos de 75 mm tipo Roloc.



Ref.	Código	Potencia W	Velocidad r.p.m.	Continuada	€ / u.
21132011	YA6008	410	Utilización	Peso Kg.	167,00

Pulidora vertical



Ref.	Código	Rosca de eje	Potencia W	Capacidad disco mm	Velocidad r.p.m.	Utilización	Peso Kg.	€/ u.
21132015	YA7500	5/16" UNF	450	125	1.800	Continuada	1	258,00

Desbarbadora angular



BG-4



BG-125P



BG-5



BG-7



BG-180



FA-6C-6M



FA-9C-4M



FA-20-1F

Ref.	Código	Potencia W	Consumo l/h	Disco mm	Conexión	Ø Manguera mm	Peso kg	Longitud mm	r.p.m	Peso Kg.	€/ u.
211800	BG-4	700	400	100 x 16	1/4	10	2,0	228	12.000	1	512,80
211801	BG-125P	700	400	125 x 22	1/4	10	1,9	230	10.000	2,0	184,45
211802	BG-5	800	900	125 x 22	1/4	13	2,0	200	12.000	1,9	430,45
211803	BG-7	1.300	1.100	180 x 22	3/8	13	3,2	254	7.600	2,0	637,55
211810	BG-180	1.300	1.100	180 x 22	3/8	13	2,4	273	7.000	3,2	592,65
211806	FA-6C-6M	1.400	1.100	180 x 22	3/8	13	3,0	353	8.400	2,4	1.259,60
211807	FA-9C-4M	1.800	1.650	230 x 22	1/2	13	4,7	385	5.900	3,0	1.678,95
21007001	FA-20-1F	300	500	50 x 9,5	1/4	10	0,7	186	15.000	4,7	814,10

Desbarbadora angular



YA805



YA911



YA912



YA9014



YA1261



YA832

Ref.	Código	Potencia W	Capacidad disco mm	Rosca de eje	Utilización	Velocidad r.p.m.	Peso kg	€ / u.
214747	YA805	510	125	M-14	Intermitente	10.000	1,75	172,00
214748	YA911	650	125	M-14	Continuada	11.000	1,8	276,00
214749	YA912	700	125	M-14	Continuada	10.900	1,9	393,00
21132008	YA9014	1.340	125	M-14	Intensa	12.000	2,10	656,00
214751	YA1261	1.200	180	M-14	Intensa	7.500	3,5	482,00
214755	YA832	1.450	180	M-14	Continuada	7.600	3,7	602,00

Lima y sierra



AS-12



AF-10S



AS-11



AS-15

Ref.	Código	Capacidad Acero	Capacidad Aluminio	Recorrido hoja	r.p.m.	Longitud mm	Consumo l/h	Ø Manguera mm	Conexión	Peso kg	€ / u.
211900	AS-12	3	3	10	10.000	230	280	10	1/4	0,8	272,55
211901	AF-10S	3	3	10	5.500	210	280	10	1/4	0,8	736,25
211902	AS-11	1,6	1,6	10	10.000	230	250	8	1/4	0,6	121,15
211903	AS-15	8	10	20	5.500	200	280	10	1/4	0,7	292,95

Sierra y limadora



Mango de goma con un tamaño reducido. Incluye 3 sierras para metal



Ref.	Código	Oscil. Min	Recorrido piston	Utilización	Peso Kg.	€ / u.
21132013	YA311KIT	9.500	10	Continuada	0,4	222,00



Amoladora



Ref.	Código	Potencia W	Capacidad	Consumo l/h	Longitud mm	Ø Manguera mm	r.p.m	Pinza	Conexión	Peso kg	€ / u.
212015	MIS	75	10	150	170	6	60.000	3	1/4	0,1	396,60
212016	NG-50AH	260	50	400	166	10	15.000	6	1/4	0,7	324,35
212002	200AH	300	25	250	120	8	20.000	6	1/4	0,6	119,15
212003	2011	300	25	300	146	8	20.000	6	1/4	0,6	75,00
212004	218	670	40	400	185	8	18.000	6	1/4	0,6	134,70
212005	NG-45	350	50	400	165	10	20.000	6	1/4	0,8	431,15
212007	NG-65	500	65	500	360	10	16.000	6	3/8	1,2	557,15
212008	NG-65L	500	65	500	425	10	16.000	6	3/8	1,3	656,65
212009	NG-75	500	75	600	360	10	15.000	6	3/8	1,3	610,30
212010	NG-75L	500	75	600	570	10	15.000	6	3/8	2,5	902,05
212017	MA-260	105	13	250	132	6	60.000	3	1/4	0,13	305,60
212018	MA-272	105	5	250	132	6	72.000	6	1/4	0,25	361,75
212019	NG-40	300	50	400	172	10	24.000	6	1/4	0,6	357,00
212021	FG-50H-1F	350	50	430	191	10	18.000	6	1/4	0,8	603,80
212022	FG-26HL-1F	300	25	350	273	8	24.000	6	1/4	0,7	680,50
212023	NG-95L	1.000	65	380	655	10	22.300	6	3/8	1,75	387,60
21007002	GT-MG55SR	105	13	160	170	6	55.000	3	1/4	0,1	350,00
212020	FG-26H-1F	275	25	580	179	10	24.000	6	1/4	0,6	531,45

Amoladora



Ref.	Código	Descripción	Potencia W	Diametro muela máx. mm.	Pinza	Utilización	Velocidad r.p.m.	Peso kg	€ / u.
212110	YA501	Cuerpo de composite, salida del aire posterior	750	50	6	Continuada	22.000	0,8	145,00
212111	YA502	Tamaño reducido, salida del aire frontal	230	25	6	Intermitente	25.000	0,3	75,00
212112	YA503	Con funda de goma, salida del aire frontal	280	25	6	Intermitente	20.000	0,5	88,00
21132009	YA508	Cuerpo de composite, salida del aire posterior	410	35	6	Continuada	22.000	0,66	126,00
212113	YA7200	Con funda de goma, salida del aire porterior	250	25	6	Continuada	23.000	0,4	123,00
212120	YA648	Para trabajos exigentes, salida del aire lareral	300	40	6	Intensa	24.000	0,73	305,00
212116	YA501L	Cuerpo de composite, salida del aire posterior	750	50	6	Continuada	22.000	1,2	221,00
212121	YA546	Angular 90°, salida del aire posterior	750	50	6	Continuada	12.000	1,2	205,00
212118	YA7201	Angular 90°, salida del aire posterior	250	25	6	Continuada	20.000	0,5	174,00
212122	YA544	Angular 120°, salida del aire posterior	300	25	6	Intermitente	20.000	0,55	138,00

Amoladora acodada 45°



Ref.	Código	Potencia W	Capacidad	Consumo l/h	Manguera	Longitud	Pinza	R	r.p.m	Peso kg	€ / u.
212100	2011AHP125	300	25	250	8	194	6	1/4	18.000	0,6	135,00

Pulidora angular



Regulador de velocidad. Plato de 178 mm



Ref.	Código	Potencia W	Rosca de eje	Capacidad disco	Velocidad r.p.m.	Utilización	Peso Kg.	€ / u.
8001551	YA4703	950	M-14	178 mm	2.500	Continuada	2,3	354,00

Sierra de sable



Ref.	Código	Oscil. Min	Recorrido pistón	Utilización	€/ u.
21132012	YA313	10.000	10	intermitente	116,00

Martillo, cincel y pisón



FC-01/K



FC-1Z/K



FC-2Z/K



FC-4Z/K



F-25CN



FP-35CN



FNS-2-1F



FNS-2P-1F



FCH-20-1F



FCH-25-1F



FRH-6A-1



FRH-6A-2

Ref.	Código	Carrera mm	Cincel tipo	Consumo l/h	Longitud mm	N° Percusiones i.p.m.	Ø Manguera mm	Ø Pistón	Peso kg	€/ u.
212400	FC-01/K	45	Hex-12	400	243	3.000	10	20	2,6	333,80
212401	FC-1Z/K	25	Hex-14,8	600	300	3.000	13	28,5	5,0	455,45
212402	FC-2Z/K	51	Hex-14,8	600	342	2.500	13	28,5	5,7	474,10
212403	FC-4Z/K	102	Hex-14,8	650	424	1.700	13	28,5	8,1	549,40
212404	F-25CN	22	19 Agujas - 3 mm	200	410	4.000	10	25	2,6	289,40
212415	FP-35CN	20	19 Agujas - 3 mm	300	330	3.700	10	23,5	2,7	276,40
212406	FNS-2-1F	7	19 Agujas - 3 mm	180	347	8.000	10	25	1,9	673,95
212407	FNS-2P-1F	7	19 Agujas - 3 mm	180	309	8.000	10	25	2,5	786,50
212408	FCH-20-1F	16	11	140	201	12.000	8	20	1,0	375,45
212409	FCH-25-1F	20	12,7	180	220	8.000	10	25	1,5	545,70
212411	FRH-6A-1	45	8,7	400	193	3.000	10	20	1,5	659,95
212412	FRH-6A-2	45	10,2	400	193	3.000	10	20	1,5	659,95

Sopladora cuerpo Antiestático ATEX



Certificación ATEX 112G 11B T6



Ref.	Código	Rosca gas	Caudal L/m	€ / u.
21132016	YA5951	1/4"	450	24,95

Pistola de soplar



AN-13



AK-13



AZ-13



AX-13

Ref.	Código	Descripción	€ / u.	Ref.	Código	Descripción	€ / u.
2300000	AN-13	Pistola corta	19,72	2300002	AZ-13	Pistola con cuello largo silenciosa	25,05
2300001	AK-13	Pistola con cuello largo	19,72	2300003	AX-13	Pistola con efecto Venturi	31,00

Sopladora cuerpo composite



YA5913



YA5819



YA5818

Ref.	Código	Rosca gas	Caudal L/m	Lanza mm	€ / u.	Ref.	Código	Rosca gas	Caudal L/m	Lanza mm	€ / u.
8001587	YA5913	1/4"	450	100	15,65	2400599	YA5818	1/4"	450	100	8,90
8001588	YA5819	1/4"	450	300	12,60						

Sopladora cuerpo aluminio



Tipo bolígrafo regulador de caudal

Ref.	Código	Rosca gas	Caudal L/m	€ / u.
8001590	YA5916	Conexión directa	300	6,75



Lápiz grabador



Ref.	Código	Entrada de aire	Longitud mm	Peso kg	r.p.m	€ / u.
212600	909	1/4	170	0.2	10.000	164,50



Pistola para sellantes



YA917



YA920



YA915

Ref.	Código	Capacidad cartucho ml	Capacidad saquito ml	Medida del tubo mm	Utilización	Peso kg	€ / u.
215000	YA917	310	310 - 400	50 x 215	Intensa	1,02	210,00
215001	YA920	-	310 - 620	50 x 412	Intensa	1,26	273,00
215004	YA915	310	-	50 X 215	Intermitente	1,1	47,00

Ventosa VEN-1 20 KG



Ref.	Código	Descripción	Diámetro cm	Modelo	€ / u.
215050	30024	Ventosa simple con cuerpo fabricado en plástico reforzado Abs	12,3	VEN 1	21,76

Ventosa VEN-2 30 KG



Ref.	Código	Descripción	Diámetro cm	Modelo	€ / u.
215051	30025	Ventosa doble con cuerpo fabricado en plástico reforzado ABS	11,7	VEN 2	54,19

Ventosa ALUMINIO 1



Ref.	Código	Descripción	Diámetro cm	Modelo	€ / u.
215052	30026	Ventosa simple con cuerpo fabricado en aleación de aluminio de alta densidad	12,3	VENAL 1	45,16

Ventosa ALUMINIO 2



Ref.	Código	Descripción	Diámetro cm	Modelo	€ / u.
215053	30027	Ventosa doble con cuerpo fabricado en aleación de aluminio de alta densidad	12,3	VENAL 2	68,56

Ventosa con cuerpo de plástico técnico



Ventosas con cuerpo de plástico técnico resistente y mango ergonómico para manipular cómodamente las baldosas cerámicas de gran formato y/o de mayor peso y facilitar la colocación y el transporte. Diámetro de las ventosas de 120 mm, para garantizar la sujeción de las piezas, con capacidad de carga de 40 Kg. (simple) y 70 Kg. (doble). Para la manipulación de baldosas de gran formato de hasta 70 Kg., hojas de vidrio y láminas de otros materiales con superficies lisas.



Ref.	Código	Diámetro ventosa (en mm)	Capacidad kg	€ / u.
2400600	SUCP40SP	120	40	13,82

Ventosa doble con cuerpo de plástico técnico



Ventosas con cuerpo de plástico técnico resistente y mango ergonómico para manipular cómodamente las baldosas cerámicas de gran formato y/o de mayor peso y facilitar la colocación y el transporte. Diámetro de las ventosas de 120 mm, para garantizar la sujeción de las piezas, con capacidad de carga de 40 Kg. (simple) y 70 Kg. (doble). Para la manipulación de baldosas de gran formato de hasta 70 Kg., hojas de vidrio y láminas de otros materiales con superficies lisas.



Ref.	Código	Diámetro ventosa (en mm)	Capacidad kg	€ / u.
2400601	SUCP70SP	120	70	26,61

Ventosa con cuerpo de aluminio



Ventosas con cuerpo de aluminio resistente y mango ergonómico para manipular cómodamente las baldosas cerámicas de gran formato y/o de mayor peso. Facilitar la colocación y el transporte. Diámetro de la ventosa de 120 mm (versión simple y doble) y 115 mm (versión triple), para garantizar la sujeción de las piezas, con capacidad de carga de 40 Kg. (simple), 70 Kg. (doble) y 100 Kg. (triple). Con goma blanca para evitar marcar las piezas. Para la manipulación de baldosas de gran formato de hasta 100 Kg, hojas de vidrio y láminas de otros materiales con superficies lisas.



Ref.	Código	Diámetro ventosa (en mm)	Capacidad kg	€ / u.
2400602	SUCA40SP	120	40	17,01

Ventosa doble con cuerpo de aluminio



Ventosas con cuerpo de aluminio resistente y mango ergonómico para manipular cómodamente las baldosas cerámicas de gran formato y/o de mayor peso. Facilitar la colocación y el transporte. Diámetro de la ventosa de 120 mm (versión simple y doble) y 115 mm (versión triple), para garantizar la sujeción de las piezas, con capacidad de carga de 40 Kg. (simple), 70 Kg. (doble) y 100 Kg. (triple). Con goma blanca para evitar marcar las piezas. Para la manipulación de baldosas de gran formato de hasta 100 Kg, hojas de vidrio y láminas de otros materiales con superficies lisas.



Ref.	Código	Diámetro ventosa (en mm)	Capacidad kg	€ / u.
2400603	SUCA70SP	120	70	35,14

Ventosa triple con cuerpo de aluminio



Ventosas con cuerpo de aluminio resistente y mango ergonómico para manipular cómodamente las baldosas cerámicas de gran formato y/o de mayor peso. Facilitar la colocación y el transporte. Diámetro de la ventosa de 120 mm (versión simple y doble) y 115 mm (versión triple), para garantizar la sujeción de las piezas, con capacidad de carga de 40 Kg. (simple), 70 Kg. (doble) y 100 Kg. (triple). Con goma blanca para evitar marcar las piezas. Para la manipulación de baldosas de gran formato de hasta 100 Kg, hojas de vidrio y láminas de otros materiales con superficies lisas.



Ref.	Código	Diámetro ventosa (en mm)	Capacidad kg	€ / u.
2400604	SUCA100SP	120	100	50,06

Ventosa con bomba de vacío



Ventosa de 200 mm de diámetro con bomba de vacío de fácil manejo con un sólo dedo, dispone de indicador de vacío, válvula de liberación manual y maleta para garantizar el transporte. Máxima capacidad de sujeción 100 Kg. Para la manipulación de materiales pesados o baldosas de gran formato sin importar el acabado superficial.



Ref.	Código	Diámetro ventosa (en mm)	Capacidad kg	€ / u.
2400605	SUCR100RBPN	203	100	74,95

Enrolladores para aire



YA6815



YA6825



YA6841



YA6851

Ref.	Código	Descripción	Longitud m	Presión de trabajo Kg/cm2	Rosca entrada de aire	Peso kg	€ / u.
212125	YA6815	Manguera PVC reforzado int. 6 mm	15	20	1/4"	4.82	134,00
212126	YA6825	Manguera PVC reforzado int. 8 mm	15	20	1/4"	5.41	145,00
212127	YA6838	Manguera PVC reforzado int. 8 mm	20	20	1/4"	8.51	167,00
212128	YA6835	Manguera PVC reforzado int. 10 mm	15	20	3/8"	6.59	156,00
212129	YA6840	Manguera PVC reforzado int. 13 mm	15	20	1/2"	8.5	203,00
212130	YA6841	Manguera Caucho reforzado int. 10 mm	20	20	3/8"	24	377,00
212131	YA6843	Manguera Caucho reforzado int. 13 mm	20	20	1/2"	29	493,00
212132	YA6851	Manguera Caucho reforzado int. 13 mm	25	20	1/2"	34	727,00
212133	YA6852	Manguera Caucho reforzado int. 13 mm	30	20	1/2"	46	907,00

Equilibrador



Ref.	Código	Descripción	Capacidad kg	Carrera cable de acero mm	€ / u.
212250	EWT-2	Equilibrador	0,5 - 1,5	1,3	61,40
212251	2003-E	Equilibrador	0,6 - 1,5	1,4	33,90
212252	EWT-3	Equilibrador	1 - 3	1,3	112,20
212253	2004-E	Equilibrador	1,5 - 3	1,4	33,90
212254	EWT-5	Equilibrador	2,5 - 5	1,3	123,60
212255	2007-E	Equilibrador	3 - 5	1,4	73,50
212258	EWT-9	Equilibrador	4,5 - 9	1,3	259,60
212259	EWT-15	Equilibrador	9 - 15	1,3	300,40
212260	EWT-22	Equilibrador	15 - 22	1,5	620,40
212261	EWT-30	Equilibrador	22 - 30	1,5	654,70
212262	EWf-40	Equilibrador	30 - 40	1,5	968,55



2003-E



EWT-15

Espiral poliamida



Ref.	Código	Longitud m	Ø	Presión bar	Rosca	€ / u.
2302200	20009	30	6 x 8	20	-	45,80
2302201	20009-5	5	6 x 8	20	1/4"	21,60
2302202	20009-7,5	7,5	6 x 8	20	1/4"	25,70
2302203	20009-10	10	6 x 8	20	1/4"	29,20
2302204	20009-15	15	6 x 8	20	1/4"	39,50
2302205	20014	30	8 x 10	20	-	60,80
2302206	20014-5	5	8 x 10	20	1/4"	23,90
2302207	20014-7,5	7,5	8 x 10	20	1/4"	29,70
2302208	20014-10	10	8 x 10	20	1/4"	35,80
2302209	20014-15	15	8 x 10	20	1/4"	48,20



Espiral TPU serie estándar



Ref.	Código	L total	Ø	Presión bar	Rosca	€ / u.
2301861	TPU08-03AM	3	5 x 8	8	1/4"	19,50
2301862	TPU08-06AM	6	5 x 8	8	1/4"	24,50
2301863	TPU08-09AM	9	5 x 8	8	1/4"	28,50
2301864	TPU10-06AM	6	6,3 x 9,5	8	1/4"	28,50
2301865	TPU10-09AM	9	6,3 x 9,5	8	1/4"	34,60
2301866	TPU10-15AM	15	6,3 x 9,5	8	1/4"	46,00
2301867	TPU12-06AM	6	8 x 12	8	1/4"	33,50
2301868	TPU12-09AM	9	8 x 12	8	1/4"	42,50
2301869	TPU12-15AM	15	8 x 12	8	1/4"	56,50



Espiral PU-AZ gran calidad



Ref.	Código	L total	Ø	Presión bar	Rosca	€ / u.
2301851	PU08-025AZ	2,5	5 x 8	8	1/4"	18,50
2301852	PU08-050AZ	5	5 x 8	8	1/4"	21,50
2301853	PU08-075AZ	7,5	5 x 8	8	1/4"	26,50
2301854	PU10-025AZ	2,5	6,3 x 9,5	8	1/4"	22,50
2301855	PU10-050AZ	5	6,3 x 9,5	8	1/4"	26,50
2301856	PU10-100AZ	10	6,3 x 9,5	8	1/4"	37,50
2301857	PU12-025AZ	2,5	8 x 12	8	3/8"	25,50
2301858	PU12-050AZ	5	8 x 12	8	3/8"	31,50
2301859	PU12-100AZ	10	8 x 12	8	3/8"	45,50



Purificador con regulador y lubricador de aire



Ref.	Código	Caudal	Rosca	€ / u.
2301700	FR+L-1/4	700	1/4"	120,95
2301701	FR+L-3/8	2.200	3/8"	158,55
2301702	FR+L-1/2	2.200	1/2"	158,55



Purificador con regulador de aire



Ref.	Código	Caudal	Rosca	€ / u.
2301600	FR-1/4	700	1/4"	75,25
2301601	FR-3/8	2.500	3/8"	102,15
2301602	FR-1/2	2.500	1/2"	102,15



Regulador de aire



Ref.	Código	Caudal	Rosca	€ / u.
2301500	R-1/4	700	1/4"	53,80
2301501	R-3/8	2.500	3/8"	69,90
2301502	R-1/2	2.500	1/2"	69,90
2301503	R-3/4	4.500	3/4"	169,30
2301504	R-1	4.500	1"	169,30



Purificador de aire



Ref.	Código	Caudal	Rosca	€ / u.
2301400	F-1/4	1.720	1/4"	40,80
2301401	F-3/8	4.100	3/8"	57,80
2301402	F-1/2	4.100	1/2"	57,80
2301403	F-3/4	11.000	3/4"	141,15
2301404	F-1	11.000	1"	108,80



Purificador, regulador y lubricador de aire



Ref.	Código	Caudal	Rosca	€ / u.
2301900	FRL-1/4	700	1/4"	139,80
2301901	FRL-3/8	2.500	3/8"	198,90
2301902	FRL-1/2	2.500	1/2"	198,90
2301903	FRL-3/4	4.500	3/4"	518,35
2301904	FRL-1	4.500	1"	518,35



Lubricador de aire



Ref.	Código	Caudal	Rosca	€ / u.
2301800	L-1/4	1.100	1/4"	51,10
2301801	L-3/8	4.300	3/8"	68,60
2301802	L-1/2	4.300	1/2"	68,60
2301803	L-3/4	16.000	3/4"	182,75
2301804	L-1	16.000	1"	182,75



Espiga hembra



Ref.	Código	Rosca	€ / u.	Ref.	Código	Rosca	€ / u.
2303000	23SFIW13SXN	1/4"	3,26	2303002	23SFIW21SXN	1/2"	6,00
2303001	23SFIW17SXN	3/8"	3,26				



Enchufe rápido espiga



Caudal 800 Lts./min.

Ref.	Código	Ø Espiga mm	€ / u.	Ref.	Código	Ø Espiga mm	€ / u.
2302700	24KATF06MPX	6	11,90	2302702	24KATF10MPX	10	11,90
2302701	24KATF08MPX	8	11,90	2302703	24KATF13MPX	13	12,78



Enchufe rápido hembra



Caudal 800 Lts./min.

Ref.	Código	Rosca	€ / u.	Ref.	Código	Rosca	€ / u.
2302600	24KAIW13MPX	1/4"	11,23	2302602	24KAIW21MPX	1/2"	11,70
2302601	24KAIW17MPX	3/8"	11,23				



Enchufe rápido macho



Caudal 800 Lts./min.

Ref.	Código	Rosca	€ / u.	Ref.	Código	Rosca	€ / u.
2302500	24KAAW13MPX	1/4"	11,23	2302502	24KAAW21MPX	1/2"	11,70
2302501	24KAAW17MPX	3/8"	11,23				



Enchufe rápido de seguridad hembra



Anti latigazo Cuerpo de composite.

Ref.	Código	Rosca gas	Caudal L/m	€/ u.	Ref.	Código	Rosca gas	Caudal L/m	€/ u.
8001555	SE6102014	1/4"	900	19,55	8001558	SE8102038	3/8"	2.000	25,80
8001556	SE6102038	3/8"	900	19,95	8001559	SE8102012	1/2"	2.000	25,80
8001557	SE6102012	1/2"	900	19,95					



Enchufe rápido de seguridad espiga



Anti latigazo Cuerpo de composite.

Ref.	Código	Ø espiga mm	Caudal L/m	€/ u.	Ref.	Código	Ø espiga mm	Caudal L/m	€/ u.
8001565	SE6103006	6-7	900	19,95	8001568	SE8103008	8	2.000	26,95
8001566	SE6103008	8	900	19,95	8001569	SE8103010	10	2.000	26,95
8001567	SE6103010	10	900	19,95	8001570	SE8103013	13	2.000	26,95



Conector espiga



Ref.	Código	Ø Espiga mm	€/ u.	Ref.	Código	Ø Espiga mm	€/ u.
2302900	23SFAK13SXN	6	3,11	2302902	23SFAK21SXN	10	6,05
2302901	23SFAK17SXN	8	3,11	2302903	23SFTF06SXN	13	3,00



Conector macho



Ref.	Código	Rosca	€/ u.	Ref.	Código	Rosca	€/ u.
2302800	23SFTF08SXN	1/4"	2,69	2302802	23SFTF13SXN	1/2"	3,57
2302801	23SFTF10SXN	3/8"	3,00				



Enchufe rápido de seguridad macho



Anti latigazo Cuerpo de composite.

Ref.	Código	Rosca gas	Caudal L/m	€/ u.	Ref.	Código	Rosca gas	Caudal L/m	€/ u.
8001560	SE6102014	1/4"	900	19,55	8001563	SE8102038	3/8"	2.000	25,80
8001561	SE6102038	3/8"	900	19,95	8001564	SE8102012	1/2"	2.000	25,80
8001562	SE6102012	1/2"	900	19,95					



Adaptador rosca hembra



Acero niquelado

Ref.	Código	Rosca gas	Caudal L/m	Ø Paso	€/ u.	Ref.	Código	Rosca gas	Caudal L/m	Ø Paso	€/ u.
8001571	SE6101014	1/4"	900	5,5	19,55	8001573	SE6101012	3/8"	2.000	8,5	19,55
8001572	SE6101038	3/8"	900	5,5	19,55	8001574	SE8101038	1/2"	2.000	8,5	26,95



Adaptador rosca macho



Acero niquelado

Ref.	Código	Rosca gas	Caudal L/m	Ø Paso	€/ u.	Ref.	Código	Rosca gas	Caudal L/m	Ø Paso	€/ u.
8001575	SE8101012	1/4"	900	5,5	26,95	8001578	IRP086102	3/8"	2.000	8,5	4,43
8001576	IRP066101	3/8"	900	5,5	2,36	8001579	IRP086103	1/2"	2.000	8,5	4,54
8001577	IRP066102	1/4"	2.000	8,5	2,47						



Adaptador espiga



Acero niquelado

Ref.	Código	Ø espiga mm	Caudal L/m	Ø Paso	€ / u.
8001580	IRP066806	6-7	900	5,5	1,84
8001581	IRP066808	8	900	5,5	1,84
8001582	IRP066810	10	900	5,5	2,13
8001583	IRP086808	8	2.000	8,5	3,57

Ref.	Código	Ø espiga mm	Caudal L/m	Ø Paso	€ / u.
8001584	IRP086810	10	2.000	8,5	3,74
8001585	IRP086813	13	2.000	8,5	4,43
8001586	IRP086816	16	2.000	8,5	7,48



Racor codo macho - macho



Ref.	Código	Rosca	€ / u.
2303600	14315	1/8"	1,77
2303601	14316	1/4"	2,42

Ref.	Código	Rosca	€ / u.
2303602	14317	3/8"	3,17
2303603	14318	1/2"	5,21



Racor macho - espiga



Ref.	Código	Rosca / Ø Espiga mm	€ / u.
2303500	13231	1/8" - 6	0,91
2303501	13234	1/4" - 6	1,18
2303502	13236	1/4" - 8	1,29
2303503	13253	1/4" - 10	1,29
2303504	13239	3/8" - 8	2,42

Ref.	Código	Rosca / Ø Espiga mm	€ / u.
2303505	13256	3/8" - 10	1,67
2303506	13258	3/8" - 13	1,77
2303507	13243	1/2" - 13	2,69
2303508	13245	1/2" - 17	2,80
2303509	13246	1/2" - 19	6,20



Racor hembra - espiga



Ref.	Código	Rosca / Ø Espiga mm	€ / u.
2303200	GI10/08	1/8" - 8	4,24
2303201	13264	1/4" - 8	2,42
2303202	13265	1/4" - 10	2,50
2303203	GI13/13	1/4" - 13	5,12

Ref.	Código	Rosca / Ø Espiga mm	€ / u.
2303204	13267	3/8" - 8	2,70
2303205	13268	3/8" - 10	3,00
2303206	GI17/13	3/8" - 13	6,42
2303207	GI21/13	1/2" - 13	6,21



Racor espiga - espiga



Ref.	Código	Rosca	€ / u.
2303400	13301	6	2,50
2303401	13303	8	2,50

Ref.	Código	Rosca	€ / u.
2303402	13304	10	2,50
2303403	DS13/13	13	4,50



Racor macho - hembra



Ref.	Código	Rosca	€ / u.
2303300	14170	1/8" - 1/8"	0,91
2303301	14171	1/8" - 1/4"	1,18
2303302	14172	1/8" - 3/8"	1,94
2303304	14175	1/4" - 1/4"	1,29

Ref.	Código	Rosca	€ / u.
2303305	14176	1/4" - 3/8"	1,94
2303307	14180	3/8" - 3/8"	2,04
2303308	14181	3/8" - 1/2"	2,80
2303310	14185	1/2" - 1/2"	3,82



Racor macho - macho



Ref.	Código	Rosca	€ / u.
2303100	14100	1/8" - 1/8"	0,81
2303101	14101	1/4" - 1/4"	1,29
2303102	14102	3/8" - 3/8"	1,67
2303103	14103	1/2" - 1/2"	2,80
2303104	14104	1/8" - 1/4"	1,29

Ref.	Código	Rosca	€ / u.
2303105	14107	1/4" - 3/8"	1,61
2303106	14108	1/4" - 1/2"	2,42
2303107	14109	3/8" - 1/2"	2,53
2303108	14110	1/2" - 3/4"	6,50
2303109	14111	3/4" - 3/4"	5,20



02



Taladro transmisión por engranajes

Sistema electromagnético de avance automático e inversor de giro para roscar, equipo de refrigeración y lámpara.



FTX-40-TEC PRO

Ref.	201585
Modelo	FTX-40-TEC PRO
Código	441535000
Capacidad broca acero	35
Capacidad broca fundición	35
Capacidad roscado	M24
Cono morse	MT4
Diámetro columna	150
Dimensiones (l x an x al)	1100 x 580 x 2270
Dimensiones mesa	560 x 560
Nº de velocidades	18 (50 - 1450)
Peso kg	500
Potencia	1.1/2 HP - 400V F3
€/ u.	5.490,00

Taladros por engranajes



3034240



3034250



3034255

Ref.	8000843	8000844	8000845
Código	3034240	3034250	3034255
Potencia del motor (2 etapas) kW	2,2/400V	1.500 -2,2/400V	2,2/400V
Ø máx. de taladro/uso continuo mm	30/26	35/30	40/35
Tipo cono morse	MT 4	MT 4	MT 4
Revoluciones del husillo rpm	75-2.000	75-2.000	90-1.520
Dimensiones mm	725x450x2.200	860x474x2.175	880x595x2.445
Peso Kgr.	312	350	525
€/ u.	4.153,00	5.294,00	6.522,00

Taladro transmisión por correa



FTX-13-TS2



FTX-16-TS2



FTX-20-TSM2



FTX-25-TCM2



FTX-20-TS PRO



FTX-25-TC PRO



FTX-35-TC PRO



FTX-35-TC PRO R+L

Ref.	201590	201591	201592	201593	201594	201595	201596	201597	201598	201599
Modelo	FTX-13-TS2	FTX-16-TS2	FTX-20-TSM2	FTX-25-TCM2	FTX-35-TCM2	FTX-35-TCT2	FTX-20-TS PRO	FTX-25-TC PRO	FTX-35-TC PRO	FTX-35-TC PRO R+L
Código	441780001	441762001	441740001	441685001	441670001	441665001	441730100	441645100	441615100	441600100
Altura total	680	980	1.000	1.600	1.710	1.710	1.085	1.690	1.780	1.780
Capacidad broca máxima	13	16	20	25	32	32	20	25	32	32
Cono morse	B16	MT2	MT2	MT3	MT4	MT4	MT2	MT3	MT4	MT4
Diámetro columna	58	72	72	80	92	92	80	80	92	92
Dimen. mesa (l x an)	200 x 200	250 x 250	290 x 290	290 x 290	360 x 360	360 x 360	280x280	290x290	410x473	410x473
Nº de velocidades	5 (620-2620)	16 (180-2770)	16 (180-2770)	12 (280-2380)	12 (150-2450)	12 (150-2450)	12 (280-2300)	12 (280-2300)	12 (210-2160)	12 (210-2160)
Peso kg	23	35	49	59	104	104	70	80	148	148
Potencia	0,5 HP-230VF1	0,5 HP-230VF1	0,75 HP-230V F1	1 HP-230V F1	2 HP-230V F1	2 HP-400V F3	1,5 HP-230V F1	1,5 HP-230V F1	3 HP-230V F1	3 HP-400V F3
€ / u.	205,00	315,00	385,00	460,00	780,00	780,00	724,00	812,00	1.480,00	1.435,00



Taladro transmisión por correa



Ref.	2400606	2400607	2400608	2400609	2400610	2400611
Código	441593000	441595000	441597000	441693000	441695000	441697000
Modelo						
€/ u.	1.242,00	978,00	738,00	2.326,00	1.705,00	1.544,00

Taladro transmisión por poleas D 33 PRO



Serie profesional. Taladro de columna con precisión garantizada (0,02 mm en el husillo). Husillo con cojinetes de bolas de precisión. Funcionamiento muy suave gracias a las poleas de aluminio y al perfecto acabado de los canales. Altura de la mesa regulable mediante mecanismo de cremallera. Tope de profundidad de perforación. Práctica mesa de trabajo con ranuras en T transversales, inclinable de -45° a +45°. Mesa de trabajo orientable en 360°. Base de trabajo maciza y de grandes dimensiones con ranuras en T, parte inferior con muchas nervaduras. Puños del avance de pínola de aluminio, con superficie Softgrip antideslizante. Precisión de concentricidad garantizada 0,02 mm, medida en la pínola del taladro. Portabrocas RÖHM de accionamiento rápido de alta calidad y de serie. Protección de grandes dimensiones y regulable en altura con interruptor de seguridad. Correa dentada de calidad para una mejor transmisión de la fuerza. Tapa de correa con interruptor de seguridad. Sistema de seguridad homologado 100%.

Ref.	21014001
Código	30030401
Dimensiones (l x an x al) mm	755x440
Espiga / cono	MT 4
Ø máx. de taladro / uso continuo mm	30/25
Potencia del motor W	1.100 / 230 V
Revoluciones del husillo rpm	120/1.800
Peso kgr.	137
€/ u.	1.537,00



Taladro OPTIdrill DQ 18 – 230V 1Ph

El Taladro de columna y sobremesa OPTIdrill DQ 18 - 230V 1Ph de OPTIMUM, código 3191042, es capaz de perforar diferentes materiales, además, gracias a su mesa de perforación inclinable podrá trabajar de una forma más cómoda, garantizando mejores acabados.

El taladro de sobremesa OPTIMUM DQ 18 cuenta con un excelente diseño que le brinda la robustez y la precisión que necesita para sus actividades de bricolaje y de taller.

Gracias a la luz de trabajo led que viene incorporada en el taladro OPTIMUM DQ 18, podrá visualizar mejor la superficie de trabajo.

En cuanto a la seguridad, el taladro OPTIdrill DQ 18 también incluye interruptor de parada de emergencia independiente.

A continuación, algunas de las características que hacen de este taladro un equipo ideal para aumentar la productividad y la calidad en su taller:

- Interruptor de parada de emergencia separado.
- Tope de profundidad de perforación.
- Mesa de perforación inclinable de $\pm 45^\circ$ y orientable en 360° .
- Poleas de aluminio para un funcionamiento suave.
- Husillo de precisión.
- Interruptores de 24 V para proteger al usuario.
- Husillo de perforación con rodamientos de bolas de precisión.
- Correas de calidad GATES.
- Mesa de trabajo con ranuras en T.
- Pantalla protectora de grandes dimensiones y ajustable en altura.
- Iluminación LED.
- Precisión garantizada (0,03 mm en el husillo).
- Portabrocas de alta calidad de serie.

El Taladro de Banco OPTIdrill DQ 18 incluye de serie:

- Mandril de perforación de acción rápida 1 - 16 mm.
- Cono Morse MT 2/B16.
- Tuercas en forma T.



Ref.	2400612
Código	3191042
568 x 319 x 849 mm	Distancia del portabrocas a la columna
127 mm	Recorrido de la pínola
65 mm	Revoluciones del husillo
600 – 2400 r.p.m.	Medidas de la mesa (l x an)
200 x 200 mm	
€ / u.	422,00

Taladro por engranaje B 40 GSP

Serie industrial. Taladro de columna con sistema de refrigeración y expulsor automático de la broca, de diseño robusto y macizo de fundición, con un motor eléctrico de poca rumorosidad y gran potencia. Sistema de avance mecánico automático. Bomba de refrigeración de serie. 2 velocidades de avance automático de la pínola. Cambio sencillo de herramientas. Mesa de taladrado maciza de grandes dimensiones, con superficie de alta calidad y ranuras tipo T en cruz y parte inferior con numerosas nervaduras. Regulable en altura mediante cremallera. Giratoria 360° sobre sí misma y respecto a la columna.

Ref.	200595
Código	3034403
Dimensiones (l x an x al) mm	935 x 560 x 2.280
Distancia del portabrocas a la columna mm	350
Ø máx. de taladro / uso continuo mm	40/35
Potencia del motor W	1.500/400 V
Revoluciones del husillo rpm	50 - 1.450
Tipo cono morse	MT 4
Peso kgr.	500
€ / u.	5.843,00





Taladro de sobremesa y columna

Mordaza y luz de trabajo incluida en todos los modelos. Protector de la broca con sistema de seguridad. Sistema de láser para el centrado de la broca en todos los modelos. Opcional equipo de refrigeración modelos YA 2220 YA 2125 YA 2132. Disponemos de estos modelos con motor trifásico.



Ref.	215065	215066	215067	215068
Código	YA2120M	YA2220M	YA2125M	YA2132T
Altura total	980	1.580	1.600	1.730
Broca máxima	20	20	25	32
Capacidad portabrocas mm	1 - 16 automático	1 - 16 automático	1 - 16 automático	1 - 16 automático
Diámetro columna	72	72	80	92
Dist. Portabrocas a la mesa	340	570	570	620
Distancia del portabrocas a la columna	160	180	175	255
Espiga	CM 2 B-18	CM 2 B-18	CM 3 B-18	CM 4 B-18
Mesa de trabajo	Ø 290	290 x 290	290 x 290	470 x 420
Motor W	650	650	750	1500 Reversible
Profundidad de trabajo	82	82	82	120
r.p.m	220 a 2.840	220 a 2.840	280 a 2.380	150 a 2.450
Velocidades	16	16	12	12
Voltaje V	220 50 Hz	220 50 Hz	220 50 Hz	380 50 Hz
Peso kg	40	60	71	130
€/ u.	678,00	851,00	919,00	1.502,00

Taladro de sobremesa y columna

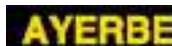

Ref.	1505150	1505151	1505152	1505155
Código	580510	580520	580530	580650
Altura columna	590	650	1.220	650
Altura total	760	1.050	1.560	800
Capacidad max.	13	20	25	16
Carrera husillo	70	85	85	85
Diámetro columna	58	72	-	58
Nº de velocidades	5	12	12	5
Potencia W	250	650	800	550
Tipo de cono	-	MT2	MT3	-
Velocidad r.p.m.	512 - 2.580	270 - 2.800	270 - 2.800	-
€/ u.	369,00	706,00	819,00	608,00

Taladro fresador de sobremesa



FTX-20-TFS VARIO



FTX-25L-TFS VARIO



FTX-32-TFS VARIO



FTX-7045-TFS M



FTX-7045-TFS T



FTX-45 TFS

Ref.	1505095	1505096	1505097	1505098	1505099	1505100
Modelo	FTX-20-TFS VARIO	FTX-25L-TFS VARIO	FTX-32-TFS VARIO	FTX-7045-TFS M	FTX-7045-TFS T	FTX-45 TFS
Código	441450000	441438000	441435000	441361000	441376000	441355000
Altura total	930	935	1.245	-	-	1.750
Capacidad broca máxima	20	25	32	45	45	40
Capacidad fresado horizontal	63	63	76	80	80	80
Capacidad fresado vertical	16	16	20	32	32	32
Cono morse	MT2	MT3	MT3	MT4	MT4	MT4
Dimensiones (l x an x al)	670 x 550 x 860	870 x 550 x 860	710 x 890 x 1120	820 x 760 x 1150	820 x 760 x 1150	1020x940x2100
Dimensiones mesa	180 x 500	180 x 700	210 x 700	240 x 800	240 x 800	240 x 800
Nº de velocidades	Variador (50 - 2250)	Variador (50 - 2250)	Variador (50 - 2250)	6 (75 - 1600)	6 (75 - 1600)	12 (75 - 3200)
Peso kg	103	125	220	320	320	580
Potencia	1,5 HP - 230V F1	1,5 HP - 230V F1	1,5 HP - 230V F1	1,5 HP - 230V F1	1,5 HP - 400V F3	1,5 HP - 400V F3
€ / u.	1.775,00	1.925,00	2.625,00	3.275,00	3.275,00	4.450,00

Taladro fresador de columna



Ref.	1505105
Modelo	FTX-40-TFC
Código	441425000
Capacidad broca máxima	40
Capacidad fresado horizontal	80
Capacidad fresado vertical	32
Cono morse	MT4
Diámetro columna	115
Dimen. mesa (l x an)	450 x 650
Dimensiones (l x an x al)	820 x 720 x 1830
Nº de velocidades	12 (75 - 3200)
Peso kg	350
Potencia	1,5 HP - 400V F3
€ / u.	3.950,00



Taladro fresador de torreta



FTX-2-FC VARIO Visualizador



FTX-4-FC VARIO Visualizador

Ref.	1505110	1505111
Modelo	FTX-2-FC VARIO Visualizador	FTX-4-FC VARIO Visualizador
Código	441315000	441300000
Cono morse	ISO40	ISO40
Diámetro husillo	85	100
Dimen. mesa (l x an)	230 x 1246	253 x 1370
Dimensiones (l x an x al)	1480 x 1680 x 2150	1490 x 1820 x 2300
Giro del cabezal	90°	90°
Giro perpendicular cabezal	45°	45°
Potencia	3HP - 400V F3	5HP - 400V F3
Velocidad r.p.m.	65 - 4200	60 - 3750
Peso kg	1.000	1.300
€ / u.	13.150,00	15.520,00

Taladro fresador universal



FTX-125-FC Visualizador



FTX-160-FC Visualizador

Ref.	1505115	20010005
Modelo	FTX-125-FC Visualizador	FTX-160-FC Visualizador
Código	441330000	441325000
Capacidad fresado horizontal	125	150
Capacidad fresado vertical	28	28
Cono morse	ISO40	ISO50
Dimen. mesa (l x an)	260 x 1120	1600x360
Dimensiones (l x an x al)	1655 x 1500 x 1730	2070x2025x2330
Giro del cabezal	360°	360°
Potencia	3HP - 400V F3	4-5,3
Peso kg	1.400	2.850
Potencia	3HP - 400V F3	400-F3
Velocidad r.p.m.	40 - 1600	60-1750
€/ u.	16.100,00	A CONSULTAR

Taladro fresador con ataque frontal



Ref.	1505120
Código	441345000
Capacidad broca máxima	50
Capacidad fresado horizontal	100
Capacidad fresado vertical	25
Capacidad máxima roscado	M16
Cono morse	ISO40
Dimen. mesa (l x an)	240 x 800
Dimensiones (l x an x al)	1280 x 1220 x 2100
Potencia	2x1,5 HP - 400V F3
N° de velocidades	8/9 (115 - 1750)
Peso kg	970
€/ u.	8.420,00



Fresadora con variador

Ref.	8000849
Código	3338136
Potencia del motor	950W/230V
Ø máx. taladro fundición/acero mm	20/16
Ø máx. fresado portacuchillas mm	52
Tipo cono morse	BT 20
Dimensiones de la mesa mm	700x180
Desplazamiento de la mesa ejes Z-Y-X mm	270-175-480
Nº de revoluciones del husillo (2 vel.)	90-3.000 r.p.m.
Dimensiones máx. mm	745x650x950
Peso kgr.	120
€/ u.	3.211,00



Fresadora OPTI MH20V

La Fresadora-Taladradora MH 20 V de Optimum, código 3338131, es una máquina herramienta que combina las funciones de fresado y taladrado en una sola unidad. Con esta máquina se pueden realizar tanto operaciones de fresado, que consisten en cortar y dar forma a un material mediante el movimiento rotativo de una herramienta, como de taladrado, que implican hacer agujeros en el material con una broca. Las fresadoras taladradoras son ampliamente utilizadas en la fabricación de piezas mecánicas y en la industria de la metalurgia, aunque también se pueden utilizar en la fabricación de componentes de plástico, madera y otros materiales.

La Fresadora-Taladradora MH 20 V cuenta con alto nivel de concentricidad, potente motor de corriente continua con control de corriente permanente, panel de control con sistemas de seguridad integrados, pantalla digital que muestra la velocidad y profundidad de perforación, interruptor de impacto para parada de emergencia.

Principales características del Fresadora-Taladradora MH 20 V:

- Cuenta con una mesa sólida y de grandes dimensiones, con ranuras en T y tiras de cuña ajustables
- Topes finales ajustables
- El cabezal de taladrado y fresado puede inclinarse $\pm 60^\circ$
- Avance fino
- Lámpara integrada
- Posee pantalla de protección regulable y con microinterruptor
- Ejes X, Y y Z con ranuras para el montaje de cintas magnéticas

Ref.	2400613
Código	3338131
94 kg	Dimensiones (l x an x al)
750 x 650 x 820 mm	Ø máx. de taladro en acero
16 / 12 mm	Revoluciones del husillo
100 - 3.000 r.p.m.	Medidas de la mesa (l x an)
510 x 180 mm	
€/ u.	1.810,00



Fresadora con caja de cambios

ASLAK
 maquinas & herramientas

3338165



3338180

Ref.	8000850	8000851
Código	3338165	3338180
Potencia del motor	1,1-1,5kW/400V	1,5-2,2kW/400V
Ø máx. taladro fundición/acero mm	32/28	38/32
Ø máx. fresado portacuchillas mm	80	80
Tipo cono morse	BT 30	BT 40
Dimensiones de la mesa mm	750x210	850x240
Desplazamiento de la mesa ejes Z-Y-X mm	460-200-450	385 (aut)-260-520
Nº de revoluciones del husillo (2 x 6 vel.)	220-3.100 r.p.m.	225-3.260 r.p.m.
Dimensiones máx. mm	850x1.030x1.340	1.210x1.020x1.645
Peso kgr.	316	525
€/ u.	5.022,00	6.916,00

Fresadora MB 4P

ASLAK
 maquinas & herramientas

Máquina fresadora universal con visualizador de posición y base de la máquina en hierro fundido. Funcionamiento suave debido a las ruedas de engranaje en baño de aceite. Gran rango de velocidad desde 95 - 3.200 r.p.m. mediante cambio de 12 velocidades conmutables. Motor eléctrico de dos etapas de gran calidad. Avance manual del husillo con avance manual fino. Avance automático husillo. Posicionamiento en eje Z. Cabezal de engranaje giratorio ± 60°. Función taladrado / roscado. Motorización de la mesa eje x y banco de serie.



Ref.	200575
Código	3338460
Desplazamiento de la mesa ejes Z-Y- X mm	350 - 195 - 560 (aut.)
Dimen. mesa (l x an) mm	800x240
Dimensiones (l x an x al)	1.220 x 930 x 2.110
Nº de revoluciones del husillo (2 vel.)	95 - 3.200 r.p.m.
Ø máx. fresa portacuchillas	63 mm
Ø máx. taladro fundición/acero (S235JR) mm	32/28
Potencia del motor (2 etapas)	1,1/1,5kW/400V
Tipo cono morse del husillo	MT 4
Peso kgr.	495
€/ u.	7.264,00

Mordaza serie 30



Bocas con efecto descendente.
Acero de cementación.
Portabocas móvil con efecto oscilante.
PERFECT

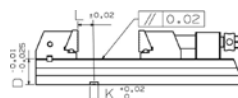

Ref.	Código	A mm	Abertura mm	C mm	Boca mm	€/ u.
2109400	30/100	250	109	33.5	100	768,60
2109401	30/100L	296	150	33.5	100	828,00
2109402	30/125	300	130	41	125	834,20
2109403	30/125L	346	175	41	125	886,40
2109419	30/125S	371	200	41	125	937,90
2109404	30/150	402	200	56	150	1.077,10
2109405	30/150L	452	250	56	150	1.186,50
2109406	30/150S	502	300	56	150	1.327,50
2109420	30/150X	527	325	56	150	1.439,30
2109407	30/175	432	225	58	175	1.322,40
2109408	30/175L	482	275	58	175	1.397,60
2109421	30/175S	556	350	58	175	1.491,20
2109422	30/175X	610	400	58	175	1.573,60

Ref.	Código	A mm	Abertura mm	C mm	Boca mm	€/ u.
2109409	30/200	470	250	66	200	1.590,40
2109410	30/200L	520	300	66	200	1.669,60
2109411	30/200S	570	350	66	200	1.960,80
2109418	30/200X	595	375	66	200	2.012,00
2109423	30/200XL	675	455	66	200	2.104,00
2109412	30/250	530	300	76	250	2.414,00
2109413	30/250L	580	350	76	250	2.609,50
2109414	30/250S	680	450	76	250	2.741,30
2109424	30/250X	755	525	76	250	2.892,600
2109415	30/300	670	390	83	300	3.714,50
2109416	30/300L	770	490	83	300	3.842,00
2109417	30/300S	870	590	83	300	4.249,20

Mordazas PARTIDAS. Grandes piezas



Mordazas partidas para grandes piezas. Bocas con efecto descendente.
Acero de cementación. Portabocas móvil con efecto oscilante.

Ref.	Código	C mm	D mm	P mm	Q mm	R mm	S mm	Boca mm	€/ u.
2109500	30/100P	33.5	37	140	90	50	30	100	903,60
2109501	30/125P	41	42	150	103	55	35	125	971,90
2109502	30/150P	56	51	180	125	58	40	150	1.352,00
2109503	30/200P	66	51	190	140	63	44	200	1.784,00

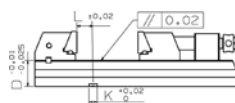

Mordaza serie PRD



Bocas con efecto descendente.
Acero de cementación.
Portabocas móvil con efecto oscilante.
PRODUCTION

Ref.	Código	A mm	Abertura mm	C mm	D mm	F mm	Boca mm	€/ u.
2109505	PRD/125	300	130	41	42	110	125	845,50
2109506	PRD/125L	346	175	41	42	100	125	902,70
2109507	PRD/150	402	200	56	51	135	150	1.258,00
2109508	PRD/150L	452	250	56	51	135	150	1.330,00
2109509	PRD/150S	502	300	56	51	135	150	1.483,00
2109510	PRD/150X	527	325	56	51	135	150	1.625,00

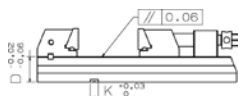

Ref.	Código	A mm	Abertura mm	C mm	D mm	F mm	Boca mm	€/ u.
2109511	PRD/200	470	250	66	61	160	200	1.692,00
2109512	PRD/200L	520	300	66	61	160	200	1.789,00
2109513	PRD/200S	570	350	66	61	160	200	1.980,00
2109514	PRD/200X	595	375	66	61	160	200	2.158,00
2109515	PRD/200XL	675	455	66	61	160	200	2.292,00

Mordaza 5 ejes. Autocentrante



Ref.	Código	A mm	Abertura mm	C mm	D mm	E mm		€/ u.
2109520	24/95	250	20-200	35	105	90		1.169,10
21043000	24/75	192	12-110	28	90	70	85	156,00
21043001	24/100	394	45-285	38	105	100	100	230,50



Mordaza taladro serie 82



Ref.	Código	Abertura mm	D mm	G mm	G mm	T mm	Boca mm	€/ u.
2109530	82/85	95	25.5	188	188	25	85	156,00
2109531	82/100	116	31.5	241	241	40	105	230,50
2109532	82/125	160	41.5	300	300	40	125	269,90
2109533	82/150	190	52.5	345	345	40	150	305,00



Mordaza autocentrante para taladro



Ref.	Código	Abertura mm	Boca mm	€/ u.
2125000	37/103	110	103	521,00



Mordaza rápidas para taladro



Ref.	Código	Abertura mm	Abertura mm	C mm	D mm	E mm	F mm	€/ u.
2125100	38/80	230	80	20	75	385	80	394,00
2125101	38/103	275	90	20	85	420	103	495,00
2125102	38/125	400	125	30	105	555	125	548,00



Mordaza modelo Master



Ref.	Código	Abertura mm	Boca mm	€/ u.
2109000	33/65M	76	65	140,50
2109001	33/85M	90	85	190,20
2109002	33/100M	116	105	298,50
2109003	33/125M	157	125	398,00
2109004	33/150M	190	150	448,00



Mordaza mecánica



Ref.	Código	Abertura mm	Boca mm	€/ u.
2109600	31/125	210	125	1.490,00
2109601	31/125L	270	125	1.575,00
2109602	31/160	325	160	1.835,00
2109603	31/160L	400	160	1.970,00



Mordaza hidráulica



Ref.	Código	Abertura mm	Boca mm	€/ u.
2109604	31/125H	210	125	1.807,00
2109605	31/125HL	270	125	1.820,00
2109606	31/160H	295	160	2.350,00
2109607	31/160HL	375	160	2.490,00



Mordaza modelo Master



2 mordazas + 1 llave

Ref.	Código	A mm	B mm	C mm	D mm	E mm	F	€/ u.
2125200	34/60	50-68	60	135	18	42	45	356,40
2125201	34/79	65-85	79	168	25	45	57	461,00
2125202	34/112	89-120	115	246	30	65	75	933,00



Sierra de cinta bajada manual



BF-85-SCV



BF-150 SCV2



BF-180 SM

Ref.	1505125	1505127	1505128
Modelo	BF-85-SCV	BF-150 SCV2	BF-180 SM
Código	421416000	421331001	421248000
Abertura mordaza	85	155	180
Capacidad corte 45°	70	50	115
Capacidad corte 60°	-	90	70
Capacidad corte 90°	85	150	150
Desarrollo de hoja	1325 x 0,65 x 13	1735 x 0,9 x 20	1735 x 0,65 x 13
Dimensiones mm	690 x 310 x 460	9800 x 430 x 500	930 x 470 x 480
Peso kg	19	34	91
Potencia	1,4HP - 230V F1	2,7HP - 230V F1	0,75HP - 230V F1
Velocidades	Variador (40-88)	Variador (45-65)	34
€/ u.	395,00	910,00	1.190,00

Sierra portátil SQ-V12 / SQ-M13 / S 131 GH

ASLAK
maquinas e herramientas

Sierra de cinta portátil con alta precisión de corte y velocidad de corte ajustable con variador de velocidad. Uso no industrial. Guía de la hoja mediante cojinete de bolas para un desarrollo de la cinta y corte óptimos. Arco de sierra giratorio de 0° a +60°, para serrar en ángulo. Equipada con hoja de sierra de cinta bimetalica de alta calidad. Tope ajustable de detención del material para trabajos en serie. Base equipada con pies antideslizantes.

Ref.	200610
Código	3300131
Capacidad corte 45° mm	85 x 70 x 90
Capacidad corte 60° mm	56 x 45 x 45
Capacidad corte 90° mm	100 x 145 x 128
Desarrollo de la hoja de sierra mm	1.638 x 13 x 0,65
Dimensiones mín. (l x an x al) mm	965 x 498 x 1.060
Potencia del motor W	1.100/230 V
Velocidad de la hoja de sierra m/min	22 / 31 / 55
Peso kgr.	78
€ / u.	1.300,00



Sierra fija S 150 G Vario / S 275 N / S 300 DG / S 350 DG

ASLAK
maquinas e herramientas

3300150



3300260

Ref.	200615	200620
Código	3300150	3300260
Capacidad corte 45° mm	105 x 130 x 125	145 x 180 x 145
Capacidad corte 60° mm	65 x 65 x 65	90 x 120 x 90
Capacidad corte 90° mm	150 x 160 x 150	225 x 245 x 150
Desarrollo de la hoja de sierra mm	1.735 x 12,7 x 0,9	2.480 x 27 x 0,9
Dimensiones mín. (l x an x al) mm	930 x 510 x 1.240	1.200 x 530 x 1.320
Potencia del motor W	1.100/230 V	1.100/400 V
Velocidad de la hoja de sierra m/min	20-65	45/90
Peso kgr.	100	185
€ / u.	1.710,00	2.885,00

Sierra OPTIsaw SQ-V13 230/1Ph/50Hz



La Sierra OPTIsaw SQ-V13 230/1Ph/50Hz de OPTIMUM, código 3194013, es una sierra de cinta portátil especial para cortes a inglete con alta precisión de corte. Destaca por su bajo ruido y diseño ergonómico que permite un fácil manejo durante el trabajo.

La velocidad de la Sierra de cinta OPTIsaw SQ-V13 es variable, adaptándose a los requerimientos de su taller. Algunas de las características más importantes de la Sierra de cinta OPTIsaw SQ-V13 son:

De serie con hoja de sierra bimetálica de alta calidad.

Tope de material regulable para trabajos en serie.

El pulsador en el brazo de palanca para el funcionamiento de la hoja de sierra, enciende y apaga el funcionamiento de la hoja de sierra.

Base con pies antideslizantes.

El arco de la sierra se puede girar de 0° a +60° para permitir cortes de sierra en ángulo.



Ref.	2400614
Código	3194013
640 x 382 x 420 mm	Capacidad máx. de corte a 90° redondo
125 mm	Capacidad máx. de corte a 90° rectangular
125 x 125 mm	Capacidad máx. de corte a +45° redondo
85 mm	Capacidad máx. de corte a +45° rectangular
85 x 85 mm	
€/ u.	453,00

Sierra fija S 150 G Vario / S 275 N / S 300 DG / S 350 DG



3290290



3290350

Ref.	200625	200630
Código	3290290	3290350
Capacidad corte 45° mm	215 x 190 x 200	230 x 210 x 220
Capacidad corte 60° mm	135 x 135 x 135	140 x 140 x 220
Capacidad corte 90° mm	255x310x190	270x230x350
Desarrollo de la hoja de sierra mm	2.750 x 27 x 0,9	2.925 x 27 x 0,9
Dimensiones mín. (l x an x al) mm	1.680 x 700 x 1.600	1.750 x 1.075 x 1.420
Potencia del motor W	1500/400V	2200/400V
Velocidad de la hoja de sierra m/min	35/70	36/72
Peso kgr.	335	550
€/ u.	4.978,00	7.358,00

Sierra de cinta semiautomática



BF-270-SC TF



BF-310-SC TF



BF-310-HV/SA



FTX-212-SC



FTX-272-SC



FTX-280-SCL

Ref.	20010014	20010015	20010016	20010017	20010018	20010019
Modelo	BF-270-SC TF	BF-310-SC TF	BF-310-HV/SA	FTX-212-SC	FTX-272-SC	FTX-280-SCL
Código	421085000	421077000	421059000	421210000	421095000	421078000
Abertura mordaza	260	315	315	-	-	-
Capacidad corte 45° izquierda	-	210/210x170/170	210/210x170/170	-	-	175/145/145/145
Capacidad corte 45°	150/150x125/125	210/210x170/170	210/210x170/170	125/95x120/95	185/230x170/180	190/190x180/170
Capacidad corte 90°	227/260x200/200	230/315x170/170	230/315x170/170	170/150x190/150	225/150x245/190	235/x190x280/200
Desarrollo de hoja	2455x0,9x27	2825x0,9x27	2825x0,9x27	2080x0,9x20	2480x0,9x27	2645x0,9x27
Dimensiones mm	1460x720x1100	1630x870x970	1630x900x1550	1290x640x870	1360x580x930	1580x770x1100
Potencia	1,1-1,5	1,1-1,5	1,1-1,5	0,75-1	1,1-1,5	1,1-1,5
Velocidad r.p.m.	36-72	40-80	40-80	60	45-90	45-90
Peso kg	190	350	380	146	185	272
€ / u.	2.580,00	4.220,00	7.200,00	2.370,00	2.795,00	4.275,00

Sierra de cinta semiautomática



FTX-355-SC



FTX-350-SC/SA

Ref.	20010020	20010021
Modelo	FTX-355-SC	FTX-350-SC/SA
Código	421040000	421035000
Abertura mordaza	-	-
Capacidad corte 45° izquierda	290/250/250	200/200x150/175
Capacidad corte 45°	355/280x340/280	230/220/220
Capacidad corte 90°	355/280x500/280	270/260x320/260
Desarrollo de hoja	3770x1,1x34	2925x0,9x27
Dimensiones mm	2280x970x1130	1930x970x1120
Potencia	1,9-2,5	1,9-2,5
Velocidad r.p.m.	35-70	36-72
Peso kg	552	600
€/ u.	8.250,00	9.850,00

Lijadora banda industrial



FTX-75-PM



FTX-75-PT



FTX-150A-PT

Ref.	Código	Modelo	Dimensiones banda mm	Longitud lijado plano mm	Peso kg	Potencia	Velocidades m/seg	€/ u.
205960	442150000	FTX-75-PM	2000 x 75	530	75	4HP - 230V F1	34	950,00
205961	442155000	FTX-75-PT	2000 x 75	530	75	4HP - 400V F3	34	910,00
205962	442160000	FTX-150A-PT	2000 x 150	530	150	4HP - 400V F3	34	1.155,00

Lijadora banda MBSM 100-130-2 / MBSM 75-200-2



Para metal de alta calidad para industria. Resistente lijadora para trabajos profesionales con metales. Excelente potencia de lijado gracias a la gran polea de contacto. Recorrido libre de vibraciones para un mejor resultado del trabajo. Superficie plana de lijado de grandes dimensiones. Cambio fácil de banda de lijado. Acabado estándar con conexión central para la aspiración. Con dos velocidades de banda. Para pulir acero y acero inoxidable.



Ref.	200655	200656
Código	3921225	3922075
Dimensiones (l x an x al)mm	360	950
Dimensiones banda mm	100 x 1.220	75 x 2.000
Ø conector aspiración mm	2x75	2x100
Ø rueda de contacto mm	130	200
Potencia del motor kW	1,5 /400V	2,2 /400V
Superficie de lijado mm	100	75
Velocidad de la banda	9,5/19	14,5/29
Peso kgr.	37	72
€/ u.	590,00	1.011,00

Lijadora / biseladora tubos



Ref.	Código	Modelo	Ángulo de lijado	Dimensiones banda mm	Peso kg	Potencia	Velocidades m/seg	€/ u.
205965	442170000	FTX-76-PBT	30°-90° [0°-60°]	2000 x 100	188	3,75 HP - 400V F1	15 - 30	1.950,00

Esmeriladora



GBG 35-15



GBG 60-20

Ref.	Código	Modelo	Potencia W	Ø de disco lijador	Velocidad de giro en vacío	Anchura del disco de amolar	Taladro del disco de amolar	Peso kg	€/ u.
8004516	060127A300	GBG 35-15	350	150	3.000	20	20	10	232,00
8004517	060127A400	GBG 60-20	600	200	3.600	25	32	15	335,00



Esmeriladora



FTX-175 EM



FTX-250 ET



FTX-200 EM



FTX-200 ECM

Ref.	Código	Modelo	Dimensiones muela mm	Potencia	Velocidad r.p.m.	Peso kg	€/ u.
207715	441965000	FTX-175 EM	175 x 25 x 32	0,68HP - 230V F1	2.950	18	155,00
207716	441967000	FTX-200 EM	200 x 32 x 32	0,82HP - 230V F1	2.950	28	189,00
207717	441969000	FTX-250 ET	250 x 32 x 32	1,22HP - 400V F3	2.950	32	260,00
207718	441971000	FTX-200 ECM	200 x 32 x 32 / cepillo 200 x 20 x 32	1,22HP - 230V F1	2.950	27	230,00

Esmeriladora



Ref.	Código	Potencia del motor W	Dimensiones de la muela mm	Nº de revoluciones rpm	Dimensiones mm	Peso kgr.	€/ u.
8000856	3101505	450/230V	Ø150x20 Ø16	2.850	389x206x266	10.7	189,00
8000857	3101510	450/230V	Ø175x25 Ø32	2.850	389x233x279	12.3	199,00
8000858	3101515	600/230V	Ø200x30 Ø32	2.850	495x261x331	18.5	252,00
8000859	3101520	600/400V	Ø200x30 Ø32	2.850	495x261x331	18.5	279,00
8000860	3101525	1.500/400V	Ø200x30 Ø32	2.850	471x319x365	32.5	399,00

Esmeriladora



DS 125 M



DS 150 M



DS 200 Plus

Ref.	Código	Denominación	Potencia W	Monofásica / trifásica	Ø disco mm	Peso Kg	€/ u.
2400615	604125000	DS 125 M	200	monofásica	125 x 20 x 20	6.7	119,48
2400616	604150000	DS 150 M	370	monofásica	150 x 20 x 20	8.7	144,20
2400617	604200000	DS 200 Plus	600	monofásica	200 x 25 x 32	17.5	280,16

Esmeriladora



YA6150B



YA6150



YA11250



YA11200

Ref.	Código	Dimensiones muela mm	Motor H.P.	Velocidad r.p.m.	V/Hz	Peso kg	€ / u.
1502300	YA6150B	Muela 150 x 20 x 12,7 y banda de lija 50 x 686	1/2	2.850	230/50	11,50	188,00
1502301	YA6150	Muelas de 150 x 25 x 12,7	1/2	2.850	230/50	11,50	158,00
1502302	YA8200	Muelas de 200 x 25 x 20	3/4	2.850	230/50	19,50	225,00
1502303	YA8200T	Muelas de 200 x 25 x 20	3/4	2.850	380/50	19,50	225,00
1502304	YA10250	Muelas de 250 x 25 x 25	1	2.850	230/50	27,50	294,00
1502305	YA10250T	Muelas de 250 x 25 x 25	1	2.850	380/50	27,50	294,00
2400618	YA11250	Muelas de 250 x 32 x 25	1,25	2.950	230/50	33	360,00
1502309	YA11200	Muela 200 x 32 x 20	1,25	2.950	230/50	28,00	325,00

Pulidora de banco



FTX-200 PM



FTX-250 PT

Ref.	Código	Modelo	Dimensiones muela mm	Potencia	Velocidad r.p.m.	Peso kg	€ / u.
207725	441973000	FTX-200 PM	200 x 20 x 16	1,22HP - 230V F1	2.950	14	225,00
207726	441977000	FTX-250 PT	250 x 25 x 20	1,22HP - 400V F3	2.950	24	250,00



Torno de sobremesa

FTX-300X180-TO VARIO+: Torno con regulador electrónico de velocidad e indicador digital de velocidad. Plato de 3 garras Ø 80 mm incluido.

FTX-520X200-TO: Torno de engranajes. Plato de 3 garras Ø 125 mm, pedestal y puntos fijos incluidos.

FTX-750X250-TO VARIO: Torno con variador de velocidad electrónico y reversible. Roscado a mano izquierda. Dial de rosca. Plato de 3 garras Ø 125 mm, contraplato, luneta fija y móvil, puntos fijos MT2 y MT4 y pedestal incluido.

FTX-700X280-TO VARIO: Torno con regulador electrónico de velocidad e indicador digital de velocidad. Roscado a mano izquierda. Dial de rosca. Avance automático del carro. Plato de 3 garras Ø 160 mm con paso de barra 38 mm. Contraplato, luneta fija y móvil, punto fijo MT3 y reductor MT5 a MT3 y pedestal incluido.



FTX-300X180-TO VARIO+



FTX-520X200-TO



FTX-750X250-TO VARIO



FTX-700X280-TO VARIO

Ref.	207735	207736	207737	207738
Modelo	FTX-300X180-TO VARIO+	FTX-520X200-TO	FTX-750X250-TO VARIO	FTX-700X280-TO VARIO
Código	441230000	441220000	441110000	441105000
Dimensiones mm	800 x 480 x 460	1250 x 570 x 570	1500 x 560 x 570	1400 x 700 x 680
Distancia entre puntos	300	520	750	700
Ø interior husillo	21	20	26	38
Ø sobre bancada	180	200	250	280
Peso kg	60	110	140	230
Potencia	1HP - 230V F1	0,75HP - 230V F1	1.5HP - 230V F1	2HP - 230V F1
Rango pasos pulgadas	8-44	8-32	8-56	8-56
Rango pasos métricos	0,5-3	0,4-3	0,2-3,5	0,2-3,5
€ / u.	1.258,00	1.995,00	2.835,00	4.050,00

Torno de sobremesa TU 1503V

ASLAK
herramientas al brinde

Torno compacto con velocidad electrónica ajustable. Perfecto para el modelista. Motor corriente continua. Bancada prismática de fundición gris, templada inductivamente y de gran precisión en el rectificado. Guías de bancada templadas y rectificadas. Precisión de concentricidad garantizada del eje del cabezal 0,015 mm. Precisión efectiva de funcionamiento plato de torno máx. 0,05 mm. Husillo principal para torneado longitudinal manual o automático. Desplazamiento longitudinal, transversal del carro superior. Rotación derecha izquierda conmutable mediante el panel de control. Plato con pantalla protectora. Volantes con escala de precisión ajustable 0.04/0.01 mm. Doble soporte de herramienta. Todas las guías ajustables a través de la guía en V sin holgura. Requisitos de seguridad según CE. Interruptor de seguridad de fácil manejo.



Ref.	200635
Código	3420260
Cono morse del contrapunto	MT 1
Cono morse del husillo principal	MT 1
Dimensiones (l x an x al) mm	560 x 320 x 290
Distancia máx. entre puntos mm	265
Gama de velocidades del husillo	120 - 3.000 r.p.m.
Ø máx. sobre bancada mm	150
Peso kgr.	23
Potencia del motor W	450/230 V
€ / u.	1.016,00

Torno de sobremesa

ASLAK
herramientas al brinde

3420350



3427200

Ref.	8000852	8000853
Código	3420350	3427200
Potencia del motor kW	0,75/230V	1,1/400V
Distancia máx. entre puntos mm	550	800
Ø máx. sobre bancada mm	250	310
Cono morse del husillo principal	MT 3	MT 5
Cono morse del contrapunto	MT 2	MT 3
Gama de velocidades del husillo rpm	125-2.000	150-2.000
Dimensiones mm	1.310x520x560	1.525x705x575
Peso kgr.	125	226
€ / u.	1.805,00	3.824,00

Torno de sobremesa

ARRATTOOLS
herramientas al brinde

Ref.	20010006
Modelo	FTX-350X180-TO VARIO
Código	441240000
Dimensiones mm	810x306x315
Distancia entre puntos	350
Ø interior husillo	20
Ø sobre bancada	180
Peso kg	40
Potencia	0,72-1
Rango pasos pulgadas	-
Rango pasos métricos	9 tipos/0,5-2,5
€ / u.	875,00





Torno con bancada. FTX-914X300-TO T

FTX-914X300-TO T, FTX-914X300-TO M: Torno de engranajes con avance del carro automático. Plato de 3 garras Ø 160 mm y de 4 garras Ø 200 mm, plato de bridas, porta brocas MT3, punto rotativo MT3, punto fijo MT3, luneta móvil y fija, lámpara y equipo de refrigeración incluido.



Ref.	207740
Modelo	FTX-914X300-TO T
Código	441085000
Ancho de bancada mm	1.050
Espesor max. plancha mm	3
Ø rodillos mm	90
Potencia	1,1-1,5
Peso kg	480
€ / u.	6.320,00

Torno de bancada



3403045



3462070

Ref.	8000854	8000855
Código	3403045	3462070
Ángulo max. curvado	0-135°	380-F3
Espesor max. plancha mm	2,5	0,75/1
Peso kg	285	60x1,5
		210
		600x800x1450
	53	52
Cono morse del contrapunto	MT 3	MT 4
Dimensiones mm	1.950x820x1.530	2440x915x1375
Peso Kgr.	500	1.340
€ / u.	11.243,00	10.727,00

Protección maquinaria para torno.



Material plástico transparente, contra impacto y sin fijación.



Ref.	1505600	1505601	1505602	1505603	1505604	1505607	1505609
Modelo	140.01	140.02	140.03	140.04	140.05	140.08	140.10
Código	492000501	492000502	492000503	492000504	492000505	492000508	492000510
Alimentación	380-F3	0.8	1.2	400-F3	180	240	300
Potencia	1,5/2	110	140	0,75/1	400	550	800
Capacidad tubo acero	70x2	56	62	32			
peso	400	30	50	1,2			
Dimensiones [l x an x al]	900x1355x1400	380x180x380	560x220x500	140			
				62			
				135			
				900x450x1350			
€ / u.	32,00	44,00	37,00	49,00	60,00	120,00	235,00

Protección maquinaria para torno. Fijación universal



Fijación universal cromada con microinterruptor para pantalla



Ref.	1505685	1505686
Modelo	140.20	140.25
Código	492000646	492000649
Pantalla Ø mm	200 - 500	550 - 1000
€ / u.	144,00	165,00

Protección maquinaria para torno.



Material plástico transparente, contra impacto y sin fijación.



Ref.	1505640	1505641	1505642	1505643	1505644	1505645
Modelo	141.T1	141.T2	141.T3	141.T4	141.T5	141.T6
Código	492000611	492000612	492000613	492000614	492000615	492000616
Ancho mm	240	240	240	240	240	240
Ø mm	300	350	400	450	500	600
€ / u.	163,00	165,00	168,00	170,00	177,00	182,00

Protección maquinaria para torno.



Material plástico transparente, contra impacto y sin fijación.



Ref.	1505680	1505681	1505682	1505683
Modelo	151.01	151.M1*	152.01	152.M2*
Código	492000631	492000633	492000632	492000634
Altura total mm	315	315	365	365
Ancho mm	300	300	350	350
Longitud mm	400	400	570	570
Panel frontal mm	100	100	150	150
Plato superior mm	200	200	260	260
Soporte brazo mm	200	200	250	250
€ / u.	275,00	325,00	415,00	485,00



Roscadora eléctrica de brazo

La Roscadora eléctrica de brazo MWKZ12H – M3-M12 de METALWORKS, código 790004413, cuenta con un potente servomotor que le permite hacer frente a diversas aplicaciones en su taller. Gracias al control PLC, controlado a través de una pantalla táctil, puede automatizar sus procesos de fabricación, destacando por la fácil configuración de los parámetros, generando fácil introducción de la bobina, profundidad y velocidad adecuada a la tarea realizada. La Roscadora eléctrica de brazo MWKZ12H destaca por su ahorro de energía y por requerir bajo mantenimiento, permitiendo optimizar las jornadas de fabricación, además, es más silenciosa que un roscador neumático y viene equipada con control de velocidad variable y con husillo de roscado horizontal y vertical ajustable.

Si desea dar un paso orientado a la automatización de los procesos en su taller, entonces la Roscadora eléctrica de brazo MWKZ12H – M3-M12 es una excelente opción para usted.

La roscadora eléctrica MWKZ12H Incluye de serie:
Pinzas M3 - M4 - M5-M6 - M8 - M10 - M12 - M14 - M16.

*No incluye banco ni macho de roscar.

Accesorios opcionales para la roscadora eléctrica MWKZ12H:

Mesa de trabajo ranurada código 790005000

Adaptador base magnética 300 kg código 790004300

Capacidad de roscado

Acero: M3 - M12

Acero inoxidable: M3 - M12

Área de trabajo horiz.: 1.100 mm

Área de trabajo vert.: 400 ajustable



Ref.	Código	Velocidad	Potencia	Tensión de alimentación	€/ u.
2400619	790004413	0 - 1.200 r.p.m.	600 W	220 V	1.353,00

Roscadora eléctrica de brazo



Roscadore Eléctrico de Brazo modelo MWKZ16CM de MetalWorks. Con articulación universal.

Capacidad de roscado:

Acero: M3 - M16

Aluminio: M3 - M16

Acero inoxidable: M3 - M16

Velocidad: 0 – 312 r.p.m.

Área de trabajo horizontal: 1100mm

Área de trabajo vertical: 400 ajustable

Contiene: Brazo de roscado, servomotor y reductor, pinzas M3 - M4 - M5-M6 - M8 - M10 - M12 - M14 - M16.

*No incluye banco ni macho de roscar.



Ref.	Código	Potencia	Tensión de alimentación	€/ u.
2400620	790004416	600 W	220 V	1.290,00

Roscadora eléctrica de brazo



La Roscadora eléctrica de brazo MWKZ24H – M4-M24 de METALWORKS, código 790004425, cuenta con un potente servomotor que le permite hacer frente a diversas aplicaciones en su taller. Puede automatizar sus procesos de fabricación gracias al control PLC, controlado a través de una pantalla táctil, destacando por la fácil configuración de los parámetros, generando fácil introducción de la bobina, profundidad y velocidad adecuada a la tarea realizada.

La Roscadora eléctrica de brazo MWKZ24H requiere bajo mantenimiento y destaca por su ahorro de energía, permitiendo optimizar las jornadas de fabricación, además, es más silenciosa que un roscador neumático y viene equipada, además, con control de velocidad variable y con husillo de roscado horizontal y vertical ajustable.

Si desea dar un paso orientado a la automatización de los procesos en su taller, entonces la Roscadora eléctrica de brazo MWKZ24H – M4-M24 es una excelente opción para usted.

La roscadora eléctrica MWKZ24H Incluye de serie:

Pinzas M6 - M8 - M10 - M12 - M14 - M16 - M18 - M20 - M22-M24.

*No incluye banco ni macho de roscar.

Capacidad de roscado

Acero: M4 - M20

Aluminio: M4 - M24

Acero inoxidable: M4 - M20

Área de trabajo horiz.: 1.200 mm

Área de trabajo vert.: 400 ajustable

Accesorios opcionales para la roscadora eléctrica MWKZ24H:

Mesa de trabajo ranurada código 790005000

Adaptador base magnética 600 kg código 790004600



Ref.	Código	Velocidad	Potencia	Tensión de alimentación	€ / u.
2400621	790004425	0 - 550 r.p.m.	1.200 W	220 V	1.790,00

Roscadora eléctrica de brazo



Roscadore Eléctrico de Brazo modelo MWKZ36CM de MetalWorks. Con articulación universal.

Capacidad de roscado:

Acero: M6 - M33

Aluminio: M6 - M33

Acero inoxidable: M6 - M33

Velocidad: 156 r.p.m.

Área de trabajo horizontal: 1300mm

Área de trabajo vertical: 400 ajustable

Contiene: Brazo de roscado, servomotor y reductor, pinzas M6 - M8 - M10 - M12 - M14 - M16 - M18 - M20 - M22-M24 - M27 - M30 - M33 - M36

*No incluye banco ni macho de roscar.



Ref.	Código	Potencia	Tensión de alimentación	€ / u.
2400622	790004436	1.200 W	220 V	1.895,00

Bordonadoras



FTX-08-BMK



FTX-12-BMK



FTX-12-BEK

Ref.	Código	Modelo	Espesor máx.chapa	Longitud cilindro	Ø rodillos mm	Peso Kg	Dimensiones (l x an x al)	€/ u.
20010011	551020005	FTX-08-BMK	0.8	110	56	30	380x180x380	845,00
20010012	551020010	FTX-12-BMK	1.2	140	62	50	560x220x500	985,00
20010013	551020015	FTX-12-BEK	1.2	140	62	135	900x450x1350	3.220,00

Cizalla guillotina



Cizalla de guillotina para el corte de chapa de acero con ancho de bancada de 500 a 1.000 mm. Capacidad de corte hasta 1,2 mm de grosor de plancha. Para corte de planchas de acero.

Ref.	Código	Modelo	Capacidad de bancada mm	Capacidad grueso corte mm	Peso kg	€/ u.
1504400	500372107	FTX-1x500 CG	500	1	37	298,00
1504402	500372108	FTX-1x800 CG	800	1	41	355,00
1504401	500372109	FTX-1,2x1000 CGM	1.000	1,2	70	430,00



Cizalla manual PS 125 / PS 150 / PS 300



Ideal para cortar láminas de acero y perfiles de láminas de acero. Cuerpo de la cizalla de gran estabilidad. Geometría de corte buena y ergonómica. Corte sencillo y ligero sobre toda la longitud de corte. Soporte con orificio para un montaje más seguro y fijo. El sólido mango asegura una buena parada. Superficies cortantes de calidad superior. La pieza a cortar se retiene en posición horizontal con las mordazas de sujeción ajustables. Un potente muelle impide que la cizalla se cierre sola.



Ref.	200660	200661	200662
Código	3241006	3241007	3241012
Anchura máx. de corte mm	95	115	235
Dimensiones (l x an x al) mm	245 x 110 x 935	325 x 120 x 960	490 x 155 x 1.340
Espesor máx. de chapa mm	3	4	4
Peso Kgr.	8,7	10,7	23
€/ u.	155,00	217,00	310,00

Cizalla guillotina de mesa



Cizalla de guillotina de mesa para el corte de chapa de acero con ancho de bancada hasta 1.320 mm. Capacidad de corte hasta 1,5 mm de grosor de plancha. Para el corte de planchas de acero, aluminio, cobre, etc ...



FTX-1x1000-CGB



FTX-1,5x1320-CGP

Ref.	Código	Modelo	Capacidad de bancada mm	Capacidad grueso corte mm	Peso kg	€ / u.
1504450	500373177	FTX-1x1000-CGB	1.000	0.8	238	1.950,00
1504451	500372002	FTX-1,5x1320-CGP	1.320	1	491	2.355,00

Cizalla manual BSS 1000



Para chapa, papel y otros materiales con estructura plegable.

Construcción sólida y robusta.

Pequeñas dimensiones debido a la estructura plegable.

Fácil de transportar.

Para placas de acero (400 N/ mm²) de hasta 1,2 mm y cortes sin fin hasta una anchura de 1.020 mm.

Ref.	200665
Código	3741100
Anchura máx. de corte mm	1.020
Dimensiones (l x an x al) mm	1.830 x 550 x 1.225
Espesor máx. de chapa mm	1,20
Peso Kgr.	97
€ / u.	2.422,00



Cizalla, plegadora y curvadora de chapa



Cizalla, plegadora y curvadora de chapa con matriz de ribetear desmontable. Equipado con calibrador estándar posterior. Rodillos de arrastre ranurados. Dos posiciones de palanca (izquierda o derecha).



Ref.	Código	Modelo	Ancho de bancada mm	Capacidad max. corte mm	Capacidad max. curvado mm	Capacidad max. plegado mm	Peso kg	€/ u.
1504471	500371003	FTX "3 EN 1"/760	760	1	1	1	140	825,00
1504472	500371005	FTX "3 EN 1"/1067	1.067	1	1	1	280	1.560,00
1504473	500371008	FTX "3 EN 1"/1320	1.320	1	1	1	470	1.990,00

Cilindro para plancha



Cilindro para chapa con engranajes de acero y rodillo superior de liberalización rápida (mod. CP). Rodillo superior fijo, inferior y trasero ajustable. Motor 1Hp 400V F3. Sistema Asimétrico de tres rodillos maniobrados con pedal (mod. CPE).



FTX-1,5X1300 CP



FTX-1,5X1300 CPE

Ref.	Código	Modelo	Descripción	Ancho de bancada mm	Espesor max. plancha mm	Ø rodillos mm	Potencia	Peso kg	€/ u.
1504480	500374005	FTX-1,5X1300 CP	Manual	1.300	1,5	75	-	192	1.215,00
1504481	500391101	FTX-1,5X1300 CPE	Eléctrico	1.300	1,5	75	1HP - 400V F3	280	3.350,00

Plegadora de chapa manual FSBM 1020-25 E



Plegadora con patas laterales. Uso universal en la industria y en trabajos manuales. La presión se realiza con el pie, dejando de ese modo ambas manos libres para el manipular el material. Segmentación superior estándar. Un fuerte cilindro auxiliar facilita el plegado de chapa de hasta 2,5 mm. Amplia abertura entre la viga superior e inferior de hasta 25 mm. Casquillos de fricción auto lubricantes.

Ref.	200680
Código	3772125
Anchura máx. de material mm	1.020
Ángulo máx. de plegado	135°
Dimensiones (l x an x al) mm	1.348 x 850 x 1.175
Espesor máx. de chapa mm	2,5
Peso Kgr.	285
€/ u.	2.095,00



Plegadora de chapa



Estructura totalmente soldada, de alta calidad y compacta, que aseguran un mantenimiento mínimo, junto con una maniobra simple y segura.

Ref.	Código	Modelo	Ángulo max. curvado	Espesor max. plancha mm	Peso kg	€/ u.
20010008	500373150	FTX-2,5X1020 PC	0-135°	2,5	285	1.845,00
1504491	500373109	FTX-1,5X1500 PC	0 - 135°	1,5	480	3.105,00



Cilindro para plancha



Cilindro para chapa con engranajes de acero y rodillo superior de liberalización rápida (mod. CP). Rodillo superior fijo, inferior y trasero ajustable. Motor 1Hp 400V F3. Sistema Asimétrico de tres rodillos maniobrados con pedal (mod. CPE).



Ref.	Código	Modelo	Ancho de bancada mm	Espesor max. plancha mm	Ø rodillos mm	Potencia	Peso kg	€/ u.
20010007	551005105	FTX-1050X90-CMH	1.050	3	90	1,1-1,5	480	A CONSULTAR

Curvadora para perfiles manual UB 10



Curvadora universal para el curvado en ángulo, en círculo y en espiral de materiales planos, cuadrados y redondos.

Ref.	200670
Código	3776010
Material	Acero/Aluminio/Cobre-Acero inox.
Material cuadrado mm	16 x 16 y 14 x 14
Material redondo mm	Ø 16 - Ø 14
Perfil plano curvatura de ángulos mm	6 x 50
Perfil plano curvatura redonda	10 x 50 mm
Rodillos de serie	2 x Ø 24/30/37/43/49/62/75 mm
Tubo	3/4"
Peso kgr.	32
€/ u.	627,00



Curvadora de perfiles



FTX-30-CTK



FTX-35-CTK

Ref.	20010009	20010010
Modelo	FTX-30-CTK	FTX-35-CTK
Código	551010003	551010005
Alimentación	380-F3	380-F3
Potencia	0,75/1	1,5/2
Capacidad tubo acero	60x1,5	70x2
Dimensiones (l x an x al)	600x800x1450	900x1355x1400
Dimensiones (l x an x al)	600x800x1450	900x1355x1400
Peso Kgr.	210	400
€ / u.	3.305,00	4.950,00

Curvadora para tubos manual RB 30



Para curvar en frío tubos de pared delgada de latón, cobre, acero y otros materiales. Curvado en frío sencillo de tubos de poco espesor sin deformaciones. Apta para el curvado de formas simples o complejas, 3D inclusive. Brazo de palanca e x tensible para una mayor fuerza. Fácilmente transportable, ideal para el taller, trabajos de montaje y vehículos de servicio postventa. Unidad de doblado desmontable, con placa/disco de sujeción opcional que también puede utilizarse en tornillos de banco. Provista de pie de sujeción atornillable para el taller. Disponibilidad de segmentos de doblado adicionales, también para tubos cuadrados de hasta 20 x 20 x 2 mm, etc.

Ref.	200675
Código	3776030
Espesor máx. de pared (Ø 25 mm) mm	2
Material	Acero/Aluminio/Cobre-Acero inox.
Material cuadrado mm	20 x 20 x 2
Material redondo mm	Ø 25 x 2 / Ø 22 x 2
Ø estándar de curvatura mm	4 veces x Ø del tubo, 56 - 100
Rodillos de serie mm	Ø 14, 16, 18, 20, 22, 25
€ / u.	1.522,00



Cabina limpiadora CAT135 - CAT220 - CAT340



Con contenedor de 19, 75 ó 150 l. con reserva. Bomba eléctrica de 220 V sellada y tubo flexible de metal.



754751350



754752222



754751340

Ref.	200730	200731	200732
Código	754751350	754752222	754751340
Capacidad mín./máx. l	7,5 / 10	40 / 50	70 / 83
Capacidad total l	19	75	150
Dimensiones (l x an x al)mm	220	880	890
Peso kgr.	6,5	23	42
Potencia W	45 / 220V	45 / 220V	45 / 220V
€ / u.	78,00	189,00	288,00

Cabina chorreadora de arena CAT420



Cabina chorreadora para uso profesional, equipada con aspirador y guantes de látex de gran calidad, incorporados a la estructura de la máquina. Provista de protector para una óptima visualización de la zona de trabajo. Depósito de 4,5 kg con orificio para el vaciado de material. Resistente rejilla interior con orificios para mantener limpia la superficie de trabajo. Conexión exterior para la toma de aire comprimido. Equipada con pies de goma para una mejor estabilidad. 2 salidas de aire [1 conexión de salida Ø 92 mm y Ø. 64 mm] para conexión de la succión.



Ref.	200715
Código	754751442
Conexión	3/8"
Consumo de aire l/min	400-800
Dimensiones e x t. (l x an x al) mm	1.300 x 630 x 1.700
Dimensiones int. (l x an x al) mm	1.210 x 600 x 580
Peso kgr.	122
Rango de presión de trabajo	8,6 bares
Tamaño del núcleo abrasivo	40-120
Volumen l	340
€ / u.	1.612,00

Bandeja vibrante Serie 90 kg



Serie W Estructura metálica para la protección e izado del equipo. Depósito dosificador de agua (10 Lt). Incluye elemento difusor Serie R Estructura metálica para la protección e izado del equipo. Serie G Soporte para el transporte e izado del equipo.

Ref.	2400623
Código	211166
Descripción	Base Vulkollan para la compactación de adoquines y solados
€ / u.	271,00



Bandeja vibrante Serie Reversible 120 kg



Estructura tubular de protección, dotada de anclaje para izado de la máquina. Ruedas neumáticas extraíbles, fácil transporte

Ref.	2400624
Código	21321
Base cm	40 x 63
Compactación cm	40 -50
Frecuencia Hz	90
Fuerza Centrifuga kN	21
Motor	5,5 HP / HONDA GX160
Peso kg	120
Velocidad avance	25-30 m/min
€ / u.	4.637,00



Cortadora de juntas



Ranurado para canalizaciones. Corte con dos discos en paralelo. Ancho máximo 18 mm.

Ref.	2400626	1506062
Código	2L45	2L450
Depósito l	40	30
Motor	13 HP HONDA GX390	13 HP HONDA GX390
Ø Máx. mm	450	500
Peso kg	104	123
Profundidad corte mm	155	220
€ / u.		2.615,00



Bandeja vibrante Serie 75 kg



Serie W Estructura metálica para la protección e izado del equipo. Depósito dosificador de agua [10 Lt]. Incluye elemento difusor Serie R Estructura metálica para la protección e izado del equipo. Serie G Soporte para el transporte e izado del equipo.

Ref.	1506059
Código	211136
Motor	Base Vulkollan para la compactación de adoquines y solados
€ / u.	



Pisón serie Yellow



Fiabilidad: Completa y sólida protección del motor. Triple filtro de gasoil: Cestillo en depósito, filtro con llave de paso y filtro de línea. Doble filtro de aire: incrementando la vida útil del motor (21613-21615H)

Ref.	1506047
Código	21615H
Base cm	28 x 34
Compactación cm	60 - 70
Fuerza Centrífuga kN	15
Motor	4 HP / HONDA GX 120R
Peso kg	60-70
€ / u.	2.665,00



Bandeja vibrante Serie 75 kg



Serie W Estructura metálica para la protección e izado del equipo. Depósito dosificador de agua (10 Lt). Incluye elemento difusor Serie R Estructura metálica para la protección e izado del equipo. Serie G Soporte para el transporte e izado del equipo.



21113G



21113R



21113W

Ref.	Código	Base cm	Compactación cm	Frecuencia Hz	Fuerza Centrífuga kN	Motor	Peso kg	Velocidad avance	€ / u.
1506056	21113G	42 x 55	15 - 25	90	13	5,5 HP / HONDA GX160	76	22 m/min.	2.009,00
1506057	21113R	42 x 55	15 - 25	90	13	5,5 HP / HONDA GX160	77	22 m/min.	2.061,00
1506058	21113W	42 x 55	15 - 25	90	13	5,5 HP / HONDA GX160	78	22 m/min.	2.179,00

Mesa de corte húmedo



Cabezal basculante regulable en altura: Posibilita el corte hasta 220 mm. Estructura reforzada: Estabilidad en el corte y larga vida útil. Eficaz y robusto sistema de refrigeración por agua: Alarga la vida útil del disco.

Ref.	Código	Altura máx. corte mm	Longitud máx corte mm	Motor	Ø máx. disco mm	€ / u.
1506070	2F31	110 x 2	680	3 HP 230 V - 50Hz	350 x 25,4	879,00



Pie de máquina [S-SB-AS].



S Dureza 60

Ref.	Código	Ø A	B mm	C mm	D mm	Carga kg	Flecha mm	€/ u.
228110	0 0 0	40	23	55	M-08	60	3,5±0,5	2,81
228111	0 0	60	28	80	M-10	160	4,0±1,0	6,57
228112	0	70	32	100	M-12	300	4,5±1,0	9,63
228113	1	85	30	100	M-12	500	4,5±1,0	11,74
228114	2	100	40	110	M-14	600	6,0±1,0	14,74
228115	3	120	50	120	M-16	900	7,5±1,0	19,33
228116	4	140	50	120	M-16	1.200	8,0±1,0	24,24
228117	5	160	60	120	M-16	1.750	9,0±1,0	47,72

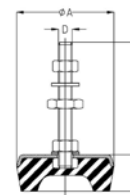
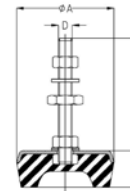
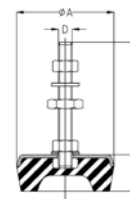

SB Dureza 70

228118	00-B	60	18	80	M-10	200	2,0±0,5	6,19
228119	0-B	70	20	100	M-12	350	2,0±0,5	9,06
228120	1-B	85	25	100	M-12	600	2,2±0,5	10,91
228121	2-B	100	20	110	M-14	800	2,5±0,5	13,72

AS

228122	AS4020-60SH	40	20	40	M-08	90	4,0±0,5	1,91
228123	AS6020-60SH	52	20	70	M-10	275	4,0±1,0	4,97

Soporte caucho metal SR



Ref.	Código	Sh	Ø A	B mm	D mm	C mm	Compresión Carga kg	Compresión Flecha mm	Cizalla Carga kg	Cizalla Flecha mm	€/ u.
228124	SR 1615	60	16	15	M-05	12	15	2,5±0,5	2	3,0±0,5	1,60
228125	SR 2008	60	20	8	M-06	15	45	1,0±0,3	4,5	1,5±0,3	1,72
228126	SR 2020	60	20	20	M-06	15	25	4,0±1,0	2,5	4,0±0,5	1,72
228127	SR 2510	50	25	10	M-08	20	80	2,0±0,5	8	2,0±0,5	1,85
228128	SR 3020	50	30	20	M-08	20	80	4,0±0,5	11	4,0±0,5	2,17
228129	SR 4028M8X30	50	40	28	M-08	30	100	5,5±1,0	16	5,5±1,0	2,56
228130	SR 4028	50	40	28	M-10	25	100	5,5±1,0	16	5,5±1,0	2,56
228131	SR 4035	50	40	35	M-10	25	100	7,0±1,0	16	7,0±1,0	2,68
228132	SR 4040	50	40	40	M-10	25	100	8,0±1,0	16	8,0±1,0	2,68
228133	SR 5035	50	50	35	M-10	25	160	7,0±1,0	25	7,0±1,0	3,70
228134	SR 7035M10X25	50	70	35	M-10	25	450	7,0±1,0	55	7,0±1,0	7,08
228135	SR 7050	50	70	50	M-12	33	300	10,0±1,0	35	10,0±1,0	9,18
228136	SR 8040	50	80	40	M-14	35	600	8,0±1,0	80	8,0±1,0	13,72
228137	SR 9525	60	95	25	M-16	42	1.800	5,0±1,0	80	5,0±1,0	15,06
228138	SR 15075	50	150	75	M-20	50	1.800	15,0±2,0	275	15,0±2,0	62,16

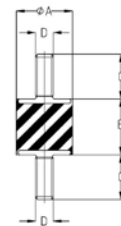

Soporte caucho metal R



Ref.	Código	Sh	Ø A	B mm	D mm	C mm	Compresión Carga kg	Compresión Flecha mm	€/ u.
228170	R 1625	60	16	25	M-05	12	15	4,5±1,0	1,47
228171	R 2015	60	20	15	M-06	15	35	3,0±0,5	1,53
228172	R 2020	60	20	20	M-06	15	25	4,0±1,0	1,53
228173	R 2530	50	25	30	M-08	20	40	6,0±1,0	1,60
228174	R 2822	50	28	22	M-08	20	60	5,0±1,0	1,85
228175	R 3030	50	30	30	M-08	20	60	6,0±1,0	1,91
228176	R 4028M8X20	50	40	28	M-08	20	100	5,5±1,0	2,10
228177	R 4028	50	40	28	M-10	25	100	5,5±1,0	2,10
228178	R 5040	50	50	40	M-10	25	155	8,0±1,0	3,26
228179	R 6060	50	60	60	M-10	25	225	12,0±1,5	4,27
228180	R 7035M10X25	50	70	35	M-10	25	450	7,0±1,0	6,13
228181	R 7070	50	70	70	M-12	33	300	14,0±1,5	9,25
228182	R 7525	50	75	25	M-12	33	650	5,0±1,0	7,90
228183	R 8030	50	80	30	M-14	35	950	6,0±1,0	8,81

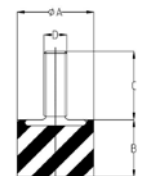

SopORTE caucho metal MR



Ref.	Código	Sh	Ø A	B mm	D mm	C mm	l mm	Compresión Carga kg	Compresión Flecha mm	Cizalla Carga kg	Cizalla Flecha mm	€ / u.
228139	MR 1610	60	16	10	M-05	12	5	20	1,5±0,5	2	2,0±0,5	1,85
228140	MR 2015	60	20	15	M-06	15	5	35	3,0±0,5	3,5	3,0±0,5	1,91
228141	MR 2520	50	25	20	M-08	20	6	50	4,0±0,5	8	4,0±0,5	2,04
228142	MR 2822	50	28	22	M-08	20	6	60	5,0±1,0	11	5,0±1,0	2,29
228143	MR 3030	50	30	30	M-08	20	6	60	6,0±1,0	11	6,0±1,0	2,29
228144	MR 4028M8X20	50	40	28	M-08	20	6	125	5,5±1,0	16	5,5±1,0	2,61
228145	MR 4028	50	40	28	M-10	25	7	125	5,5±1,0	16	5,5±1,0	2,61
228146	MR 5040	50	50	40	M-10	25	7	155	8,0±1,0	25	8,0±1,0	4,15
228147	MR 6045	50	60	45	M-10	25	7	250	9,0±1,0	35	9,0±1,0	5,62
228148	MR 7035M10X25	50	70	35	M-10	25	9	450	7,0±1,0	55	7,0±1,0	7,53
228149	MR 7070	50	70	70	M-12	33	10	300	14,0±1,5	35	14,0±1,5	11,93
228150	MR 7035	50	75	25	M-12	33	10	650	5,0±1,0	80	5,0±1,0	8,10
228151	MR 8055	50	80	55	M-14	35	11	500	11,0±1,5	70	11,0±1,5	14,49
228152	MR 9540	50	95	40	M-16	42	14	1.000	8,0±1,0	140	8,0±1,0	18,63
228153	MR 15075	50	150	75	M-20	50	20	1.800	15,0±2,0	275	15,0±2,0	68,17

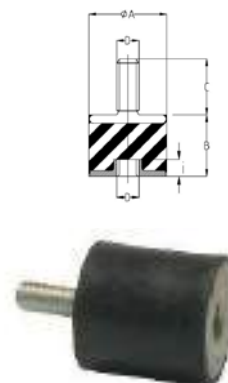

SopORTE caucho metal HR



Ref.	Código	Sh	Ø A	B mm	D mm	l mm	Compresión Carga kg	Compresión Flecha mm	Cizalla Carga kg	Cizalla Flecha mm	€ / u.
228154	HR 1615	60	16	15	M-05	5	15	2,5±0,5	2	2,0±0,5	1,98
228155	HR 2015	60	20	15	M-06	5	40	2,0±0,5	3,5	3,0±0,5	2,10
228156	HR 2530	50	25	30	M-08	6	40	6,0±1,0	5	6,0±1,0	2,24
228157	HR 2822	50	28	22	M-08	6	60	4,5±1,0	11	5,0±1,0	2,42
228158	HR 3030	50	30	30	M-08	6	60	6,0±1,0	11	6,0±1,0	2,56
228159	HR 3330	60	30	30	M-08	6	80	6,0±1,0	16	6,0±1,0	2,50
228160	HR 4028M8	50	40	28	M-08	6	125	5,5±1,0	16	5,5±1,0	2,61
228161	HR 4028	50	40	28	M-10	7	125	5,5±1,0	16	5,5±1,0	2,61
228162	HR 3430	60	40	30	M-08	6	200	6,0±1,0	40	6,0±1,0	2,61
228163	HR 5035	50	50	35	M-10	7	160	7,0±1,0	25	7,0±1,0	4,21
228164	HR 6025	50	60	25	M-10	7	400	5,0±1,0	35	5,0±1,0	5,43
228165	HR 7070M10	50	70	70	M-10	9	300	14,0±1,5	35	14,0±1,5	11,17
228166	HR 7035	50	70	35	M-12	10	450	7,0±1,0	55	7,0±1,0	8,75
228167	HR 8040	50	80	40	M-14	11	600	8,0±1,0	80	8,0±1,0	14,29
228168	HR 9540	50	95	40	M-16	14	1.000	8,0±1,0	140	8,0±1,0	20,92
228169	HR 102D60	60	102	55	M-16	14	1.000	11,0±1,5	200	11,0±1,5	19,27



SopORTE caucho metal TH



Ref.	Código	Sh	Ø A	B mm	D mm	l mm	Compresión Carga kg	Compresión Flecha mm	€ / u.
228184	TH 1610	60	16	10	M-05	5	20	1,5±0,5	1,53
228185	TH 2015	60	20	15	M-06	5	35	3,0±0,5	1,60
228186	TH 2520	50	25	20	M-08	6	40	4,0±0,5	1,85
228187	TH 3015	50	30	15	M-08	6	80	3,0±0,5	2,04
228188	TH 4028	50	40	28	M-10	7	100	5,5±1,0	2,24
228189	TH 5040	50	50	40	M-10	7	155	8,0±1,0	3,50
228190	TH 6045	50	60	45	M-10	7	250	9,0±1,0	4,35
228191	TH 7035	50	70	35	M-12	10	450	7,0±1,0	6,70
228192	TH 8040	50	80	40	M-14	11	600	8,0±1,0	10,40
228193	TH 9540	50	95	40	M-16	14	1.000	8,0±1,0	13,72



SopORTE caucho metal TP



Ref.	Código	Sh	Ø A	B mm	D mm	C mm	Compresión Carga kg	Compresión Flecha mm	Choque Carga kg	Choque Flecha mm	€ / u.
228194	TP 25	60	25	20	M-08	20	40	4,0±0,5	100	8,0±2,0	1,14
228195	TP 30	60	30	30	M-06	15	50	6,0±1,0	140	12,0±2,0	1,53
228196	TP 5050M10	60	50	50	M-10	25	90	10,0±1,5	335	20,0±3,0	3,57
228197	TP 70	60	70	60	M-12	33	160	12,0±2,0	550	24,0±3,0	5,55
228198	TP 95	60	95	80	M-16	42	350	16,0±2,0	1.100	32,0±4,0	13,21





Diábolo



SR-N

TH-N

HR-N

R-N

MR-N

Ref.	Código	Sh	Ø A	B mm	Ø E	D mm	C mm	I mm	Compresión Carga kg	Compresión Flecha mm	Cizalla Carga kg	Cizalla Flecha mm	€/ u.
228199	SR 00-N	60	20	19	13	M-06	15	-	12	4,0±1,0	2	4,0±0,5	1,91
228200	SR-N SR 2N	50	57	44	38	M-08	20	-	130	8,5±1,0	25	8,5±1,0	4,52
228201	SR 6N	50	95	76	76	M-16	42	-	450	15,0±2,0	75	15,0±2,0	20,99
228202	T 3231	60	60	43	38	M-10	25	-	250	9,0±1,0	30	9,0±1,0	4,67
228203	MR-N MR ONM 8	50	40	28	20	M-08	30	6	40	5,5±1,0	7	5,5±1,0	2,87
228204	HR-N HR 4-N	50	60	60	48	M-10	-	7	150	10,0±1,0	20	12,0±1,0	6,06
228205	R-N R 4-N	50	60	57	48	M-10	25	-	150	10,0±1,0	-	-	4,08
228206	TH-N TH 5-N	50	80	65	68	M-14	-	11	350	14,0±1,5	-	-	11,61

Soporte caucho metal SCM

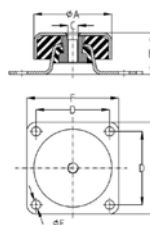

Ref.	Código	Sh	Ø A	B mm	D mm	C mm	Ø E	F mm	J mm	Carga estática Carga kg	Carga estática Flecha mm	Carga dinámica Carga kg	Carga dinámica Flecha mm	€/ u.
228207	SCP120L VMQ55	55	76	38	63,5	M-10	65	76	3	170	3,5±0,5	100	2,5±0,5	28,08
228208	SCM120 NR60	60	76	41	72	M-10	9	90	3	200	3,5±0,5	150	2,5±0,5	22,34
228209	SCM220 VMQ45	45	92	53	90	M-12	11	114	3	130	4,5±0,5	100	3,5±0,5	42,62

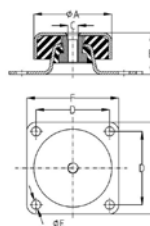

Ref.	Código	Sh	Ø A	B mm	D mm	C mm	F mm	J mm	M mm	N mm	O mm	d mm	Carga estática Carga kg	Carga estática Flecha mm	Carga dinámica Carga kg	Carga dinámica Flecha mm	€/ u.
228210	SCM325 VMQ60	60	92	53	115	M-12	140	3	11	11	11	11	220	4,5±0,5	165	3,5±0,5	40,45
228211	SCM425 NR75	75	124	78	182	M-16	230	4	18	34	26	18	1400	6,5±0,5	900	4,5±0,5	67,25

Soporte caucho metal B

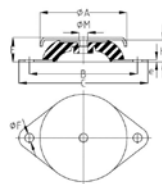

Ref.	Código	Ø A	H mm	E mm	B mm	C mm	M mm	ØF	e mm	Compresión Carga kg	Compresión Flecha mm	€ / u.
228212	B045 + BAP040 NR60	40	18	20	52	64	M-06	6,2	2	10	2,5±0,5	3,57
228213	B065 + BAP060 NR45	60	22	24	76	90	M-06	6,2	2	15	3,5±0,5	6,19
228214	B085 + BAP080 NR75	80	25	27	100	120	M-08	8,2	2	120	4,5±0,5	7,91
228215	B105 + BAP100 NR75	100	25	28	124	148	M-10	10,2	2,5	220	4,5±1,0	9,63
228216	B205 + BAP200 NR60	200	40	44	240	280	M-18	15	5	850	8,0±1,5	38,28

Soporte metálico SCC

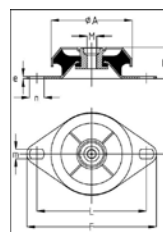

Ref.	Código	Sh	Ø A	H mm	Longitud mm	M mm	F mm	e mm	m mm	N mm	Compresión Carga kg	Compresión Flecha mm	€ / u.
228217	SCC080 M10 NR35	35	83	35	110	M-10	135	3	11,5	15	80	4,5±1,0	28,33
228218	SCC080 M10 NR45	45	83	35	110	M-10	135	3	11,5	15	130	4,5±1,0	28,33
228219	SCC080 M10 NR60	60	83	35	110	M-10	135	3	11,5	15	175	4,5±1,0	28,33
228220	SCC080 M10 NR75	75	83	35	110	M-10	135	3	11,5	15	230	3,5±1,0	28,33
228221	SCC080 M12 NR35	35	83	35	110	M-12	135	3	11,5	15	80	4,5±1,0	28,33
228222	SCC080 M12 NR45	45	83	35	110	M-12	135	3	11,5	15	130	4,5±1,0	28,33
228223	SCC080 M12 NR60	60	83	35	110	M-12	135	3	11,5	15	175	4,5±1,0	28,33
228224	SCC080 M12 NR75	75	83	35	110	M-12	135	3	11,5	15	230	3,5±1,0	28,33
228225	SCC095 M10 NR35	35	92	34	123	M-10	150	3	10	15	200	5,0±1,0	28,45
228226	SCC095 M10 NR45	45	92	34	123	M-10	150	3	10	15	300	5,0±1,0	28,45
228227	SCC095 M10 NR60	60	92	34	123	M-10	150	3	10	15	600	5,0±1,0	28,45
228228	SCC095 M10 NR75	75	92	34	123	M-10	150	3	10	15	900	5,0±1,0	28,45
228229	SCC095 M12 NR35	35	92	34	123	M-12	150	3	10	15	200	5,0±1,0	28,45
228230	SCC095 M12 NR45	45	92	34	123	M-12	150	3	10	15	300	5,0±1,0	28,45
228231	SCC095 M12 NR60	60	92	34	123	M-12	150	3	10	15	600	5,0±1,0	28,45
228232	SCC095 M12 NR75	75	92	34	123	M-12	150	3	10	15	900	5,0±1,0	28,45
228233	SCC110 M12 NR35	35	106	41	143	M-12	169	3	12,5	19	200	7,0±1,0	29,73
228234	SCC110 M12 NR45	45	106	41	143	M-12	169	3	12,5	19	340	7,0±1,0	29,73
228235	SCC110 M12 NR60	60	106	41	143	M-12	169	3	12,5	19	420	7,0±1,0	29,73
228236	SCC110 M12 NR65	65	106	41	143	M-12	169	3	12,5	19	425	5,0±1,0	29,73
228237	SCC110 M12 NR75	75	106	41	143	M-12	169	3	12,5	19	800	5,0±1,0	29,73
228238	SCC110 M16 NR35	35	106	41	143	M-16	169	3	12,5	19	200	7,0±1,0	29,73
228239	SCC110 M16 NR45	45	106	41	143	M-16	169	3	12,5	19	340	7,0±1,0	29,73
228240	SCC110 M16 NR60	60	106	41	143	M-16	169	3	12,5	19	420	7,0±1,0	29,73
228241	SCC110 M16 NR65	65	106	41	143	M-16	169	3	12,5	19	425	5,0±1,0	29,73
228242	SCC110 M16 NR75	75	106	41	143	M-16	169	3	12,5	19	800	5,0±1,0	29,73
228243	SCC150 M16 NR35	35	150	54	182	M-16	218	4	14	18	450	9,0±1,5	70,38
228244	SCC150 M16 NR45	45	150	54	182	M-16	218	4	14	18	600	9,0±1,5	70,38
228245	SCC150 M16 NR60	60	150	54	182	M-16	218	4	14	18	800	8,0±1,5	70,38
228246	SCC150 M16 NR65	65	150	54	182	M-16	218	4	14	18	1.000	8,0±1,5	70,38
228247	SCC150 M16 NR75	75	150	54	182	M-16	218	4	14	18	1.000	6,0±1,5	70,38

Soporte metálico SCR



Ref.	Código	SH	Ø A	B Longitud mm	H mm	M mm	L mm	F mm	m mm	n mm	o mm	d mm	Compresión Carga kg	Compresión Flecha mm	€/ u.
8000361	SCRI00M12NR40	40	80	60	38	M-12	100	120	11	14	11	14	35	4,0±1,0	27,34
8000362	SCRI00M12NR45	45	80	60	38	M-12	100	120	11	14	11	14	45	4,0±1,0	27,34
8000363	SCRI00M12NR55	55	80	60	38	M-12	100	120	11	14	11	14	70	4,0±1,0	27,34
8000364	SCRI00M12NR65	65	80	60	38	M-12	100	120	11	14	11	14	100	4,0±1,0	27,34
8000365	SCRI00M12NR75	35	103,5	75	52	M-16	140	186	13	30	20	13	80	5,0±1,0	27,34
8000366	SCRI40M16NR35	45	103,5	75	52	M-16	140	186	13	30	20	13	110	5,0±1,0	38,90
8000367	SCRI40M16NR45	55	103,5	75	52	M-16	140	186	13	30	20	13	160	5,0±1,0	38,90
8000368	SCRI40M16NR55	65	103,5	75	52	M-16	140	186	13	30	20	13	275	5,0±1,0	38,90
8000369	SCRI40M16NR65	75	103,5	75	52	M-16	140	186	13	30	20	13	500	5,0±1,0	38,90
8000370	SCRI40M16NR75	35	132	112	71	M-20	182	230	18	30	26	18	225	6,0±1,0	38,90
8000371	SCRI82M20NR35	45	132	112	71	M-20	182	230	18	30	26	18	400	6,0±1,0	83,86
8000372	SCRI82M20NR45	55	132	112	71	M-20	182	230	18	30	26	18	700	6,0±1,0	83,86
8000373	SCRI82M20NR55	65	132	112	71	M-20	182	230	18	30	26	18	800	6,0±1,0	83,86
8000374	SCRI82M20NR65	75	132	112	71	M-20	182	230	18	30	26	18	1.200	6,0±1,0	83,86

Soporte metálico M



M 25



M 250



M 25 B



M 150 B

Ref.	Código	Ø A	B mm	C mm	D mm	E mm	F mm	G	M mm	Compresión Carga kg	Compresión Flecha mm	Constante kg/cm	€/ u.
228248	M 25	55	79	-	-	-	-	-	8	25	20±2,0	12,5	10,52
228249	M 250	73	116	-	-	-	-	-	12	250	30±3,0	83,33	34,07
228250	M 25 B	55	81	90	55	70	10	10	8	25	20±2,0	12,5	12,56
228251	M 150 B	73	119	110	75	89	11	10	12	150	30±3,0	50	29,03
228252	M 200 BB	-	120	110	75	89	11	10	-	200	30±3,0	66,67	31,97

Soporte metálico MLC INOX



MLC25 INOX



MLC25 B INOX



MLC25BB INOX



MLC150 INOX



MLC150 B INOX



MLC150 BB INOX

Ref.	Código	Ø A	B mm	C mm	D mm	E mm	F mm	G	M mm	Compresión Carga kg	Compresión Flecha mm	Constante kg/cm	€/ u.
8000375	MLC25 INOX	55	79						8	25	24±2,0	10,42	46,18
8000376	MLC25 B INOX	55	83	91	55	70	10	10	8	25	24±2,0	10,42	60,77
8000377	MLC25BB INOX		87	91	55	70	10	10		25	24±2,0	10,42	75,35
8000378	MLC150 INOX	73	115						12	150	30±3,0	50	72,91
8000379	MLC150 B INOX	73	116,5	110	75	91	13,8	10	12	150	30±3,0	50	79,00
8000380	MLC150 BB INOX		118	110	75	91	13,8	10		150	30±3,0	50	91,15

Lanza Taladrina



Lanza metálica flexible. Fabricada en aluminio y tubo interior de silicona.
Presión máx de trabajo 6 atm. Incluye rosca de 3/8" y de 1/4"

Ref.	Código	Descripción	€/ u.
1506040	20800749	Lanza Mod.400	81,50
1506041	20800750	Lanza Mod.500	86,84
1506042	20800751	Lanza Mod.600	90,38



Escuadra magnetica



Ref.	Código	Longitud mm	€/ u.
2117300	29003	85 x 85 x 15	12,58
2117301	29004	110 x 110 x 18	20,06
2117302	29005	140 x 140 x 20	32,72



Grupo electrógeno a gasolina

AYERBE



5420000 / 5420020



5420040 / 5420080



5420120 / 5420160



5418050 / 5418060

Ref.	1505250	1505251	1505252	1505254
Código	5420000	5420020	5420040	5420080
Motor	HONDA GP-160 OHV 162 cc. 5,5 HP / 3.600 r.p.m.		HONDA GX-270 OHV 272 cc. 9,0 HP / 3.600 r.p.m.	
Alternador	LINZ SP10 SB	LINZ SP10 SE	LINZ SP10 MF	LINZ E1S10 MG
Arranque	manual	manual	manual / eléctrico	manual / eléctrico
Consumo l/h	1,1 (75%)	1,1 (75%)	1,8 (75%)	1,8 (75%)
Depósito l	3,6	3,6	6	6
Dimensiones mm	650 x 480 x 425	650 x 630 x 540	770 x 746 x 625	770 x 746 x 625
Modelo	AY-3000 H-MN	AY-3800 H-MN	AY-5000 H-MN	AY-5500 H-TX
Nivel sonoro db A	95	96	97	97
Peso kg	47	50	75	85
Potencia max.	3 KVA / 2200 W	3,8 KVA / 3000 W	5 KVA / 4200 W	5,5 KVA / 3 KVA
Potencia nominal	2,4 KVA / 1900 W	3,2 KVA / 2500 W	4,8 KVA / 3850 W	4,8 KVA / 2,5 KVA
Tensión V	230 / 50	230 / 50	230 / 50	400 / 230 V / 50 Hz
€/ u.	790,00	888,00	1.220,00	1.690,00

Ref.	1505256	1505258	1505260	1505261
Código	5420120	5420160	5418050	5418060
Motor	HONDA GX-390 (E) OHV 390 cc. 13,0 HP / 3.600 r.p.m.		HONDA GX-630 OHV 630 cc. 21,0 HP / 3.600 r.p.m.	
Alternador	LINZ E1C10 MI	LINZ E1S10 MH	SINCRO FK10	SINCRO FT12
Arranque	manual / eléctrico	manual / eléctrico	eléctrico	eléctrico
Consumo l/h	2,1 (75%)	2,1 (75%)	3,2 (75%)	3,2 (75%)
Depósito l	6,5	6,5	25	25
Dimensiones mm	950 x 746 x 625	950 x 746 x 625	950 x 746 x 720	950 x 746 x 720
Modelo	AY-8000 H-MN	AY-8000 H-TX	AY-12500 H-MN A/E	AY-12500 H-TX A/E
Nivel sonoro db A	97	97	99	99
Peso kg	85	90	150	150
Potencia max.	8 KVA / 6400 W	8 KVA / 3,5 KVA	12,5 KVA / 10000 W	12,5 KVA / 4,5 KVA
Potencia nominal	7 KVA / 5600 W	7 KVA / 3 KVA	10 KVA / 8000 W	10 KVA / 4 KVA
Tensión V	230 / 50	400 / 230 V / 50 Hz	230 / 50	400 / 230 V / 50 Hz
€/ u.	1.718,00	1.914,00	4.268,00	4.424,00

Grupo electrógeno a gasolina



Los generadores portátiles de la serie WX ofrecen una gran relación fiabilidad-coste y son ideales para uso recreativo o como sistema auxiliar para viviendas. Están equipados con AVR (regulador electrónico de voltaje) que reduce el riesgo de daños a los dispositivos de alta tecnología.



Ref.	21134004	2400627	21134005	2400628	21134007	21134008
Marca/Modelo	PRAMAC OHV	PRAMAC OHV	PRAMAC OHV	PRAMAC OHV	PRAMAC OHV	PRAMAC OHV
Código	PR242SXIZ00	PR242SXBZ03	PR532SXIZ00	PR532SXBZ03	PR552TXBZ00	PR582SXBZ00
Arranque	Manual	Eléctrico	Manual	Eléctrico	Eléctrico	Eléctrico
Alternador	Pramac	Pramac	Pramac	Pramac	Pramac	Pramac
COMBUSTIBLE	Gasolina	Gasolina	Gasolina	Gasolina	Gasolina	Gasolina
VOLTAJE	230V	230V	230V	230V	400V	230V
Dimensiones mm	685x505x520	680x602x253	810x625x607	800x698x320	810x625x607	810x625x607
Peso kg.	49	49	78	89	90	90
€ / u.	465,00	580,00	795,00	925,00	930,00	960,00

Grupo electrógeno a gasolina



Generador electrico con motor gasolina 4 tiempos, SVR y arranque electrico.



Jaca

Navacerrada

Astún

Candanchú

Ref.	Código	Modelo	Pot nominal	Pot maxima	Voltage	Regulacion	Arranque	€ / u.
2400633	11010	Jaca	3.000	3.300	230	SVR	Electrico	470,00
2400629	11020	Navacerrada	5.000	5.500	230	SVR	Electrico	530,00
2400630	11025	Astún	6.500	7.000	230	SVR	Electrico	1.015,00
2400631	11030	Candanchú	6.500	7.000	230/400	SVR	Electrico	1.149,00

Grupo electrógeno a gasolina alta potencia



Generador electrico con motor gasolina 4 tiempos, inverter, con arranque electrico y remoto.



Creta RC



Somport



Izoard



Stelvio

Ref.	Código	Modelo	Pot nominal	Pot maxima	Voltage	Regulacion	Arranque	€/ u.
2400634	13035	Creta RC	7.200	7.500	230	INVERTER	Electrico	1.149,00
2400635	12905	Somport	8.000	8.300	230/400	SVR	Electrico/remoto	1.989,00
2400636	12910	Izoard	14.000	15.000	230/400	SVR	Electrico/remoto	3.590,00
2400637	12915	Stelvio	17.000	18.000	230/400	SVR	Electrico/remoto	3.990,00

Grupo electrógeno inverter a gasolina



Generador electrico con motor gasolina 4 tiempos, inverter y arranque electrico.



Palma



Lanzarote



Mallorca



Madeira



Rodas



Feroe

Ref.	Código	Modelo	Pot nominal	Pot maxima	Voltage	Regulacion	Arranque	€/ u.
2400638	13065	Palma	1.700	1.500	230	INVERTER	Electrico	469,00
2400639	13010	Lanzarote	1.800	2.000	230	INVERTER	Electrico	790,00
2400640	13020	Mallorca	3.000	3.200	230	INVERTER	Electrico/remoto	1.044,00
2400641	13022	Madeira	3.600	4.000	230	INVERTER	Electrico	1.199,00
2400642	13025	Rodas	3.500	3.800	230	INVERTER	Electrico	603,00
2400643	13030	Feroe	4.200	4.600	230	INVERTER	Electrico	711,00

Grupo electrógeno inverter a gasolina



Los generadores inverter PMi estabilizan la tensión de salida y suministran energía para todo tipo de equipos. Garantizan una eficiencia máxima en el modo ahorro, que ajusta automáticamente la velocidad del motor al nivel óptimo con ahorro de combustible y reducción del ruido.



Ref.	21134009	21134010	21134011	21134013	21134014	21134015
Marca/Modelo	PRAMAC OHV	PRAMAC OHV	PRAMAC OHV	PRAMAC OHV	PRAMAC OHV	PRAMAC OHV
Código	PR911SXIY00	PR162SXIY00	PR282SXI000	PF262SXI000	PF312SXI000	PF302SXB000
Arranque	Manual	Manual	Manual	Manual	Manual	Eléctrico
Alternador	Pramac	Pramac	Pramac	Pramac	Pramac	Pramac
COMBUSTIBLE	Gasolina	Gasolina	Gasolina	Gasolina	Gasolina	Gasolina
VOLTAJE	230V	230V	230V	230V	230V	230V
Dimensiones mm	510x310x460	555x310x480	585x415x465	565x339x467	490x430x417	601x458x522
Peso kg.	14	22	38	27	34	49,5
€ / u.	365,00	595,00	620,00	1.120,00	1.075,00	1.330,00

Grupo electrógeno inverter a gasolina



Los generadores P inverter de Pramac ofrecen energía limpia y estable para productos electrónicos sensibles y son fáciles de transportar, eficientes en el consumo de combustible y de bajo nivel sonoro.

Ref.	2400656
Código	PF192SXI000
Arranque	Manual
Alternador	Pramac
COMBUSTIBLE	Gasolina
VOLTAJE	230V
Marca/Modelo	PRAMAC OHV
Dimensiones mm	505x270x460
Peso kg.	21
Potencia LTP kW	2.1
€ / u.	890,00





Grupo electrógeno a gasolina

Generador profesional simple. Pramac ha diseñado esta gama de generadores para asegurar un alto nivel de rendimiento a un precio atractivo. Generador potente y robusto, de fácil mantenimiento y que será pronto esencial para todas sus actividades. Generador profesional simple. Pramac ha diseñado este generador para asegurar un alto nivel de rendimiento a un precio atractivo. Generador potente y robusto, de fácil mantenimiento y que será pronto esencial para todas sus actividades.



Ref.	21134016	21134017	21134018	21134019	21134020	21134021	21134022
Marca/Modelo	Honda GX160	Honda GX200	Honda GX270	Honda GX270	Honda GX390	Honda GX390	Honda GX390
Código	PA252SH1000	PA292SH1000	PA432SH100D	PA432SH100Q	PA652SH1005	PA652SH100G	PA702TH1004
Arranque	Manual	Manual	Manual	Manual	Manual	Manual	Manual
Alternador	Nuova Saccardo Motori	Nuova Saccardo Motori	Nuova Saccardo Motori	Nuova Saccardo Motori	Nuova Saccardo Motori	Nuova Saccardo Motori	Nuova Saccardo Motori
COMBUSTIBLE	Gasolina	Gasolina	Gasolina	Gasolina	Gasolina	Gasolina	Gasolina
VOLTAJE	230V	230V	230V	230V	230V	230V	400V
Dimensiones mm	640x458x400	640x458x400	750x543x520	750x543x520	750x543x520	750x543x520	750x543x520
Peso kg.	38	38	61	61	72	72	75
€/ u.	795,00	830,00	1.010,00	1.225,00	1.350,00	1.515,00	1.570,00

Grupo electrógeno a gasolina

AYERBE

AY - 3000 MN / AY - 3800 MN



AY - 5000 MN / AY - 5200 TX



AY - 8000 MN / AY - 8000 TX

Ref.	1505265	1505266	1505267	1505268	1505269	1505270
Modelo	AY - 3000 MN	AY - 3800 MN	AY - 5000 MN	AY - 5200 TX	AY - 8000 MN	AY - 8000 TX
Código	5430000	5430010	5430020	5430030	5430040	5430050
Motor	KIOTSU KT-168		KIOTSU KT-188		KIOTSU KT-188	
Alternador	LINZ SP10SB	LINZ SP10SE	LINZ SP10MF	LINZ E1S10MG	LINZ E1C10 MI	LINZ E1S10MH
Arranque	manual / eléctrico	manual / eléctrico	manual / eléctrico	manual / eléctrico	manual / eléctrico	manual / eléctrico
Consumo l/h	1,1	1,1	1,8	1,8	2,1	2,1
Depósito l	3,6	3,6	6	6	6,5	6,5
Dimensiones mm	650 x 480 x 425	650 x 630 x 540	770 x 746 x 625	770 x 746 x 625	950 x 746 x 625	950 x 746 x 625
Nivel sonoro db A	95 LwA / 72 LpA	96 LwA / 73 LpA	97 LwA / 74 LpA	97 LwA / 74 LpA	97 LwA / 74 LpA	97 LwA / 74 LpA
Peso kg	47	50	75	85	85	90
Potencia max.	3 KVA/2200 W	3,8 KVA/3000 W	5 KVA/4200 W	5,5 KVA/3 KVA	8 KVA/6400 W	8 KVA / 3,5 KVA
Potencia nominal	2,4 KVA/1900 W	3,2 KVA/2500 W	4,8 KVA/3850 W	4,8 KVA/2,5 KVA	7 KVA/5600 W	7 KVA / 3 KVA
Tensión V	230 / 50	230 / 50	230 / 50	400 / 50	230 / 50	400 / 50
€/ u.	600,00	637,00	943,00	1.415,00	1.344,00	1.446,00

Grupo electrógeno a gasolina



Equipo listo para suministrar energía allí donde se necesite, montado sobre una estructura fuerte y compacta, equipada con un asa plegable y kit de ruedas integradas, para facilitar su transporte.



Ref.	2400644	2400645	2400646	2400647	2400648	21134003
Código	PK222SX1000	PK332SX1000	PK452SX2000	PK852SXB000	PK472TX2000	PS203TXM000
Arranque	Manual	Manual	Eléctrico	Eléctrico	Eléctrico	Eléctrico
Alternador	Pramac	Pramac	Pramac	Pramac	Pramac	Pramac
COMBUSTIBLE	Gasolina	Gasolina	Gasolina	Gasolina	Gasolina	Gas
VOLTAJE	230V	230V	230V	230V	400V	400V
Marca/Modelo	PRAMAC OHV	PRAMAC OHV	PRAMAC OHV	PRAMAC OHV	PRAMAC OHV	1232x648x733
Dimensiones mm	600x439x588	727x515x670	727x515x670	837x785x924	727x515x670	220
Peso kg.	53	79	94	143	97	
Potencia LTP kW	2.7	3.8	5.4	9.3	1.8	
€ / u.	565,00	885,00	1.030,00	2.580,00	1.185,00	8.598,46

Grupo electrógeno diesel



AY-6000 LOMBARDINI MN / AY-6500 LOMBARDINI TX

Ref.	1505280	1505281	1505284	1505285	1505286
Modelo	AY-6000 LOMBARDINI MN	AY-6500 LOMBARDINI TX	AY-12500 LOMBARDINI TX	AY-15000 LOMBARDINI MN	AY-15000 LOMBARDINI TX
Código	5418610	5418615	5418470	5418055	5418075
Motor	LOMBARDINI 15 LD440		LOMBARDINI 25 LD425		LOMBARDINI 12 LD477
Alternador	LINZ E1C10MI	LINZE1S10 MG	MECCALTE T20FS	MECCALTE S20W	MECCALTE T20F
Arranque	manual / eléctrico	manual / eléctrico	eléctrico	eléctrico	eléctrico
Consumo l/h	1,7	1,7	2,4	2,6	2,6
Depósito l	5,5	5,5	25	25	25
Dimensiones mm	950 x 746 x 625	950 x 746 x 625	950 x 746 x 625	950 x 746 x 625	950 x 746 x 625
Nivel sonoro db A	-	-	-	-	-
Peso kg	110	115	140	160	160
Potencia max.	6,5 KVA / 5200 W	6,5 KVA / 4 KVA	12,5 KVA / 5 KVA	15 KVA / 12000 W	15 KVA / 7 KVA
Potencia nominal	6 KVA / 4800 W	6 KVA / 3 KVA	10 KVA / 4 KVA	14 KVA / 11200 W	12,5 KVA / 5 KVA
Tensión V	230 / 50	400 / 50	400 / 50	230 / 50	400 / 50
€ / u.	3.002,00	3.350,00	6.039,00	4.674,00	4.674,00



Estación Genery



Estacion de energía portátil con batería .



Ref.	Código	Modelo	Pot nominal	Pot maxima	Voltaje	Regulacion	€ / u.
2400649	31500	GZE-0305	500	750	230	INVERTER	269,00
2400650	31505	GZE-0810	1.000	1.500	230	INVERTER	559,00
2400651	31510	GZE-1210	1.000	1.500	230	INVERTER	749,00
2400652	31515	GZE-1515	1.500	2.000	230	INVERTER	879,00
2400653	31520	GZE-2020R	2.000	3.000	230	INVERTER	1.599,00
2400655	31525	GZE-3320	2.000	3.000	230	INVERTER	1.799,00

Compresor a batería



Ref.	Código	Modelo	Tensión V / Ah	Caudal de llenado l/min	Presión máx Bares	Tamaño depósito L.	Peso Kg	€ / u.
21080025	601521850	Power 160-5 18 LTX BL OF	18V / sin baterías, sin cargador	70	8	5	9,9	363,59



Compresor de pistón sin aceite



No lubricado. 1 cilindro.



Ref.	Código	Modelo	Aire aspirado l/min	Depósito l	Dimensiones l x h x a	Potencia Hp/kW	Presión máx. bar	volt/hz	Peso kg	€ / u.
1505318	C6BB304NUB552	NEW VENTO 0L195 Nuair	180	6	350 x 290 x 340	1,5	8	230/MONO/50	9	164,00

Compresor de pistón FUTURA



FUTURA-227/10/12

FUTURA-227/10/50V

Ref.	Código	Modelo	Aire real l/min	Depósito l	Dimensiones l x h x a	Potencia Hp/kW	Presión máx. bar	volt/hz	Peso kg	€ / u.
1505246	HYBD404NUA	FUTURA-227/10/12	222	12	520 x 255 x 470	2	10	230/MONO/50	14,4	284,00
1505249	HYDV404NUA	FUTURA-227/10/50V	222	50	310 x 340 x 865	2	10	230/MONO/50	23	366,00

Compresor de pistón - gama TECH-PRO



Lubricado. 2 cilindros.



Ref.	Código	Modelo	Aire aspirado l/min	Depósito l	Dimensiones l x h x a	Pot. Hp/kW		Peso kg	€ / u.
2400657	28DA404NUA204	B2800B/2CM/50 TECH-PRO	255	50	820x390x750	2/1,5	230/MONO/50	50	865,00
2400658	28DA504NUA221	B2800B/3CM/50 TECH-PRO	330	50	820x390x750	3/2,2	230/MONO/50	52	880,00
2400659	28FA404NUA207	B2800B/2CM/100 TECH-PRO	255	100	1030x440x850	2/1,5	230/MONO/50	64	685,00
2400660	28FA504NUA200	B2800B/3CM/100 TECH-PRO	330	100	1030x440x850	3/2,2	230/MONO/50	71	995,00
2400661	28FA541NUA209	B2800B/3CT/100 TECH-PRO	330	100	1030x440x850	3/2,2	400/TRIF/50	71	1.055,00
2400662	28LA504NUA213	B2800B/3CM/200 TECH-PRO	330	200	1440x480x1130	3/2,2	230/MONO/50	98	1.320,00
2400663	28LA541NUA214	B2800B/3CT/200 TECH-PRO	330	200	1440x480x1130	3/2,2	400/TRIF/50	98	1.365,00

Compresor de pistón-gama SILTEK



Sin Aceite



Ref.	Código	Modelo	Aire aspirado l/min	Depósito l	Dimensiones l x h x a	Pot. Hp/kW		Peso kg	€ / u.
2400664	B2BR304NUA	SILTEK TB 6	160	6	435x435x410	1,5/1,1	230/MONO/50	20	280,00
2400665	B2DC504NUA	SILTEK TB 50 D	320	50	795x350x625	1,5/1,2	230/MONO/50	43	646,00

Compresor de pistón



Sin Aceite

Ref.	Código	Modelo	Aire aspirado l/min	Depósito l	Dimensiones l x h x a	Pot. Hp/kW		Peso kg	€ / u.
2400666	8215410NUA506	TALENTO Nuair	160	2	642x415x218	3/2,3	230/MONO/50	13	380,00



Compresor de pistón / FC2 TECH



lubricado



FC2/24S TECH



FC2/50S TECH

Ref.	Código	Modelo	Aire real l/min	Depósito l	Dimensiones l x h x a	Potencia Hp/kW	Presión máx. bar	volt/hz	Peso kg	€ / u.
21086002	FCCC404NUB550	FC2/24S TECH	222	24	575x255x590	2	8	230/MONO/50	31	216,00
21086003	FCDV404NUB551	FC2/50S TECH	222	50	830x325x665	2	8	230/MONO/50	38	298,00

Compresor de pistón fijo



Lubricado. 2 cilindros.



Ref.	Código	Modelo	Aire aspirado l/min	Depósito l	Dimensiones l x h x a	Potencia Hp/kW	Presión máx. bar	volt/hz	Peso kg	€ / u.
1505335	N5NN701LEV076	NB5/5,5 FT/270 Nuair	640	270	1550 x 590 x 1100	5,5/4	11	400/TRIF/50	175	1.745,00
1505336	N7TN801NUA	NB7/7,5 FT/500 Nuair	840	500	2080 x 700 x 1450	7,5/5,5	11	400/TRIF/50	276	2.764,00
1505337	N1TN905NUA	NB10/10 FT/500 Nuair SD	1.230	500	2080 x 700 x 1450	10/7,5	11	400/TRIF/50	286	4.130,00

Compresor de pistón Insonorizado



Ref.	Código	Modelo	Aire aspirado l/min	Depósito l	Dimensiones l x h x a	Potencia Hp/kW	Presión máx. bar	volt/hz	Peso kg	€ / u.
21086000	B2BE104NUA	SILTEK + NUAIR	105	6	370 x 370 x 375	1	8	230/MONO/50	15	198,00

Compresor de pistón fijo 15 BAR



Lubricado. 2 cilindros.



Ref.	Código	Modelo	Aire real l/min	Depósito l	Dimensiones l x h x a	Potencia Hp/kW	Presión máx. bar	volt/hz	Peso kg	€ / u.
21086004	N5NN701NUA105	NB5/5,5 FT/270 AP 15 Bar Nuair	500	270	1550x590x1100	5,5/4	15	400/TRIF/50	181	2.395,00
21086005	N7TN801NUA103	NB7/7,5 FT/500 AP 15 Bar Nuair	705	500	2080x700x1450	7,5/5,5	15	400/TRIF/50	282	3.239,00
21086006	N1TN905NUA104	NB10/10 FT/500 15 Bar AP Nuair SD	1.100	500	2080x700x1450	10/7,5	15	400/TRIF/50	302	4.647,00

Compresor de pistón insonorizado AIRSIL.



Airsil sobre caldera



Ref.	Código	Modelo	Aire	db A	Depósito l	Dimensiones l x h x a	Pot. Hp/kW	Presión máx. bar	volt/hz	Peso kg	€ / u.
21086007	28FR504NUA	AIRSIL 1 B2800B/3CM/100	330	65	100	1140x650x1200	3/2,2	10	230/MONO/50	134	220,00
21086008	28FR541NUA	AIRSIL 1 B2800B/3CT/100	330	65	100	1140x650x1200	3/2,2	10	230/MONO/50	133	2.158,00
1505306	N5AT701NUA	AIRSIL 2 NB5/5,5 FT	640	64		1080 x 720 x 820	5,5/4	11	400/TRIF/50	167	3.775,00
21086009	N7AT801NUA	AIRSIL2 NB7.7.5T_500 NUAIR N7TT801NUA	840	64	270	1180 x 780 x 1050	5,5/4	11	400/TRIF/50	190	4.250,00
1505308	N1AT905NUA	AIRSIL 3 NB10/10 FT SD	1.230	64	500	1200 x 850 x 870	10/7,5	11	400/TRIF/50	252	5.650,00

Compresor de pistón insonorizado AIRSIL con SECADOR



Airsil sobre caldera con Secador



Ref.	Código	Modelo	Aire real l/min	Depósito l	Dimensiones l x h x a	Pot. Hp/kW	Presión máx. bar	volt/hz	Peso kg	€/u.
21086010	N5TT701NUA304	AIRSIL2 NB5/5,5FT/500+ESS	640	500	2005x970x1660	5,5/4	10	400/TRIF/50	352	6.235,00
21086011	N7TT801NUA302	AIRSIL2 NB7/7,5FT/500+ESS	840	500	2005x970x1660	7,5/5,5	10	400/TRIF/50	362	6.590,00
21086012	NITT905NUA301	AIRSIL3 NB10/10FT/500 SD+ESS	1.230	500	2005x970x1660	10/7,5	10	400/TRIF/50	444	8.490,00

Compresor de piston con motor gasolina HONDA



Motor gasolina HONDA



MK236/9,5 HONDA



NB7/9S/100 HONDA AP



B3800/5,5S/10+10 HONDA



NB7/9S/100 HONDA AP

Ref.	Código	Modelo	Aire real l/min	Depósito l	Dimensiones l x h x a	Pot. Hp/kW	Presión máx. bar	Peso kg	€/u.
21086013	FMPP6P1NUA	MK236/9,5 HONDA	235	9,5	480x450x750	4/3	10	39	1.790,00
21086014	BRFC7P1FNM767	NB7/9S/100 HONDA AP	642	100	1140x610x1200	9/6,7	14	132	3.420,00
1505316	36BW7P1NUA	B3800/5,5S/10+10 HONDA	390	10+10	750 x 700 x 950	5,5	10	72	2.375,00
1505317	N7FC7P1NUA	NB7/9S/100 HONDA AP	660	100	1050 x 500 x 1060	9	10	121	3.370,00

Compresor de tornillo BASE sobre depósito



Todos los modelos están disponibles bajo solicitud, también en 10 y 13 bar.



Gama base

Ref.	Código	Modelo	Aire real l/min	db A	Dimensiones l x h x a	Pot. Hp/kW	Presión máx. bar	volt/hz	Peso kg	€/ u.
1505215	V51JO92N1N564	MERCURY Tronic 5.5-10	650	64	580 x 480 x 760	7,5	10	400/TRIF/50	125	5.348,00
1505216	V60KH92N1N764	SIRIO 8-10	1.000	68	800 x 700 x 980	10	10	400/TRIF/50	185	6.274,00
1505217	V60KE92N1N764	SIRIO 11-10	1.500	69	800 x 700 x 980	15	10	400/TRIF/50	200	6.706,00
1505218	V60KQ92N1N764	SIRIO 15-10	1.850	70	800 x 700 x 980	20	10	400/TRIF/50	235	7.074,00

Gama sobre depósito

Ref.	Código	Modelo	Aire real l/min	db A	Depósito l	Dimensiones l x h x a	Pot. Hp/kW	Presión máx. bar	volt/hz	Peso kg	€/ u.
1505391	V77JP72N1N544	MERCURY Merch 4.0-10-200	485	60	200	1440 x 510 x 1280	5,5	10	400/TRIF/50	150	4.916,00
1505392	V91JO92N1N544	MERCURY Tronic 5.5-10-270	650	64	270	1560 x 570 x 1390	7,5	10	400/TRIF/50	203	6.308,00

Gama sobre depósito

Ref.	Código	Modelo	Aire real l/min	db A	Depósito l	Dimensiones l x h x a	Pot. Hp/kW	Presión máx. bar	volt/hz	Peso kg	€/ u.
1505395	V83KH92N1N744	SIRIO 8-10-500	1.000	68	500	1980 x 700 x 1630	10	10	400/TRIF/50	307	7.576,00
1505396	V83KE92N1N744	SIRIO 11-10-500	1.500	69	500	1980 x 700 x 1630	15	10	400/TRIF/50	322	7.994,00
1505397	V83KQ92N1N744	SIRIO 15-10-500	1.850	70	500	1980 x 700 x 1630	20	10	400/TRIF/50	357	8.192,00

Compresor de tornillo . Gama sobre depósito + secador



Todos los modelos están disponibles bajo solicitud, también en 10 y 13 bar.



V91JO92N1N644

V83KE92N1N844

Ref.	Código	Modelo	Aire real l/min	db A	Depósito l	Dimensiones l x h x a	Pot. Hp/kW	Presión máx. bar	volt/hz	Peso kg	€/ u.
1505230	V77JP72N1N644	MERCURY Merch 4.0-10-200 ES	485	60	200	1440 x 510 x 1280	5,5	10	400/TRIF/50	150	6.552,00
1505231	V91JO92N1N644	MERCURY Tronic 5.5-10-270 ES	650	64	270	1560 x 570 x 1390	7,5	10	400/TRIF/50	215	7.856,00
1505232	V83KH92N1N844	SIRIO 8-10-500 ES	1.000	68	500	1980 x 700 x 1630	10	10	400/TRIF/50	375	8.888,00
1505233	V83KE92N1N844	SIRIO 11-10-500 ES	1.500	69	500	1980 x 700 x 1630	15	10	400/TRIF/50	395	9.234,00
1505234	V83KQ92N1N844	SIRIO 15-10-500 ES	1.850	70	500	1980 x 700 x 1630	20	10	400/TRIF/50	436	10.014,00

Compresor de tornillo . Gama sobre depósito + secador



Todos los modelos están disponibles bajo solicitud, también en 10 y 13 bar.



V91SH92NIN344



V83SY92NIN344

Ref.	Código	Modelo	Aire real l/min	db A	Depósito l	Dimensiones l x h x a	Pot. Hp/kW	Presión máx. bar	volt/hz	Peso kg	€ / u.
1505235	V91SH92NIN344	STAR 7.5-10-270 (IE3)	1.000	62	270	1500 x 700 x 1540	10/7,5	10	400/TRIF/50	326	9.486,00
1505236	V83SY92NIN344	STAR 11-10-500 (IE3)	1.500	63	500	1980 x 700 x 1650	15/11	10	400/TRIF/50	410	15.188,00
1505237	V83SS92NIN344	STAR 15-10-500 (IE3)	1.850	64	500	1980 x 700 x 1650	20/15	10	400/TRIF/50	436	10.700,00
1505239	V83SY92N2N544	STAR 22-10-500 (IE3)	3.000	71	500	1980 x 750 x 1810	30/22	10	400/TRIF/50	655	15.186,00

Compresor de tornillo BASE



Todos los modelos están disponibles bajo solicitud, también en 8 y 13 bar.



Ref.	Código	Modelo	Aire real l/min	db A	Dimensiones l x h x a	Potencia Hp/kW	Presión máx. bar	Peso kg	€ / u.
1505240	V60SH92NIN264	VEGA 7.5-10	1.000	62	1200 x 700 x 1010	10	10	326	7.184,00
1505241	V60SP92NIN264	VEGA 11-10	1.500	63	1200 x 700 x 1010	15	10	350	7.530,00
1505242	V60SS92NIN264	VEGA 15-10	1.850	64	1200 x 700 x 1010	20	10	410	7.786,00
1505244	V83SV92N2N544	VEGA 22-10	3.000	71	1510 x 730 x 1080	30	10	635	11.318,00

Secador DRY AIR ED



Intercambiador de calor ultracompacto y altamente eficiente, capaz de funcionar en temperaturas ambiente hasta 45°C y temperaturas de entrada de 55°C, garantizando una mínima caída de presión. Control Inteligente que indica digitalmente el Punto de Rocío, controla la válvula de drenaje de condensación y el ventilador de condensado. La válvula by-pass de gas caliente permite al secador funcionar a carga parcial evitando posibles congelaciones.



Ref.	Código	Modelo	L.P.M.	Alimentación	Peso kg	Rosca Salida Entrada	Alto mm	Longitud mm	Fondo mm	€ / u.
1506020	OY506	AIR ED - 6	600	230V / 50-60Hz	25	½"	370	515	475	1.332,00
1506021	OY509	AIR ED - 9	900	230V / 50-60Hz	26	½"	370	515	475	1.414,00
1506022	OY512	AIR ED - 12	1.200	230V / 50-60Hz	28	½"	370	515	475	1.594,00
1506023	OY518	AIR ED - 18	1.800	230V / 50-60Hz	32	½"	370	515	475	1.695,00
1506024	OY525	AIR ED - 25	2.500	230V / 50-60Hz	34	1"	345	420	740	1.972,00
1506025	OY532	AIR ED - 32	3.200	230V / 50Hz	39	1 ¼"	345	445	740	2.485,00
1506026	OY543	AIR ED - 43	4.300	230V / 50Hz	40	1 ½"	345	445	740	2.995,00
1506027	OY552	AIR ED - 52	5.200	230V / 50Hz	41	1 ¾"	345	445	740	3.327,00

Depósito de aire



Depósitos verticales para Aire comprimido y Nitrógeno. Certificados de acuerdo a la normativa 2009/105/EC CARACTERÍSTICAS: Material: acero al carbono. Fluido contenido: aire comprimido / nitrógeno. Tratamiento externo: pintura azul (Ral 5015). Directiva: 2009/105/EC. Presión: 11/16 Bar. Temperatura: -10+100°.

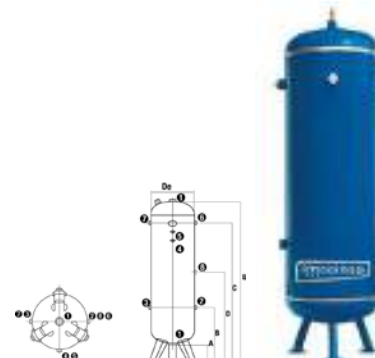

Ref.	Código	Descripción	1"	2"	3"	4"	5"	6"	7"	8"	A mm	B mm	C mm	Capacidad nominal Lt	D mm	De mm	Longitud mm	€/ u.
1506035	0Y180	Depósito vertical 270 Lt	1/2"	1"	1"	-	3/8"	1"	-	-	175	599	1.304	270	-	500	1.648	792,00
1506036	0Y182	Depósito vertical 500 Lt	1/2"	1"	1"	-	3/8"	1"	1"	-	155	785	1.665	500	-	600	2.050	1.284,00
1506037	0Y184	Depósito vertical 900 Lt	2"	1" 1/2	1" 1/2	3/8"	3/8"	1" 1/2	1" 1/2	-	145	875	1.805	900	-	800	2.140	2.250,00

Calderas Verticales



Caldera Vertical 100 lts. 11 bar Sin accesorios



Ref.	Código	Depósito l	Conexión	Dimensiones l x h x a	Peso kg	€/ u.
2400668	87FY000054	100	3/4"	370x370x1156	37	360,00
2400669	87LY000054	200	1"	446x446x1554	62	718,00
2400670	87NY000054	270	1"	500x500x1648	80	810,00
2400671	87TY010054	500	1"	600x600x2025	135	1.335,00

Accesorios Caldera



Accesorios montaje Caldera Vertical 100Lts 11Bar



Ref.	Código	Accesorios	Accesorios	€/ u.
2400672	8222912SGL	Accesorios Montaje Cald. 100lts.	Llave de corte, manómetro, válvula de seguridad, grifo purga y racores (no incluye latiguillo)	54,00
2400673	8222913SGL	Accesorios Montaje Cald. 200lts.	Llave de corte, manómetro, válvula de seguridad, grifo purga y racores (no incluye latiguillo)	70,00
2400674	8222913SGL	Accesorios Montaje Cald. 270lts.	Llave de corte, manómetro, válvula de seguridad, grifo purga y racores (no incluye latiguillo)	70,00
2400675	8222926SGL	Accesorios Montaje Cald. 500lts.	Llave de corte, manómetro, válvula de seguridad, grifo purga y racores (no incluye latiguillo)	130,00



Filtros de línea. Pre-filtros

CONDICIONES ESTÁNDAR DE SERVICIO: Temperatura máxima de trabajo: 60°C. Temperatura mínima de trabajo: 1°C. Presión máxima: 16 Atms.

Pre-filtros

Ref.	Código	Elemento filtrante Código	L.P.M.	Roscas Salida-Entrada	€ / u.
1506080	OY020	OY020F	1.000	3/8" H	110,00
1506081	OY021	OY021F	1.300	1/2" H	126,00
1506082	OY022	OY022F	2.000	3/4" H	150,00
1506083	OY023	OY023F	3.300	1" H	202,00
1506084	OY024	OY024F	5.500	1" H	237,00
1506085	OY025	OY025F	8.500	1 1/2" H	280,00
1506086	OY026	OY026F	13.000	1 1/2" H	340,00



OY020F

Filtros coalescentes

Ref.	Código	Elemento filtrante Código	L.P.M.	Roscas Salida-Entrada	€ / u.
1506090	OY030	OY030F	1.000	3/8" H	110,00
1506091	OY031	OY031F	1.300	1/2" H	126,00
1506092	OY032	OY032F	2.000	3/4" H	150,00
1506093	OY033	OY033F	3.300	1" H	202,00
1506094	OY034	OY034F	5.500	1" H	237,00
1506095	OY035	OY035F	8.500	1 1/2" H	280,00
1506096	OY036	OY036F	13.000	1 1/2" H	340,00



OY030F

Filtros a carbón activo

Ref.	Código	Elemento filtrante Código	L.P.M.	Roscas Salida-Entrada	€ / u.
1506110	OY040	OY040F	1.000	3/8" H	110,00
1506111	OY041	OY041F	1.300	1/2" H	126,00
1506112	OY042	OY042F	2.000	3/4" H	150,00
1506113	OY043	OY043F	3.300	1" H	202,00
1506114	OY044	OY044F	5.500	1" H	237,00
1506115	OY045	OY045F	8.500	1 1/2" H	280,00
1506116	OY046	OY046F	13.000	1 1/2" H	340,00



OY040F

Filtros de condensación



Ref.	Código	Elemento filtrante Código	L.P.M.	Roscas Salida-Entrada	€ / u.
21053001	OY050	OY050	2.600	1/2" H	158,00
21053002	OY051	OY051	3.916	3/4" H	181,00
21053003	OY052	OY052	6.083	1" H	233,00
21053004	OY053	OY053	12.833	1 1/2" H	284,00



Serie baja presión. Combustión directa



Ref.	Código	Potencia W/h	Capacidad depósito l	Caudal m3/h	Consumo w	Peso kg	Potencia Kcal/h	€ / u.
1505800	B 70	20.000	19	400	180	18	17.200	535,50
1505801	B 100	29.000	44	800	230	28	25.000	744,45
1505802	B 150	44.000	44	900	280	28	37.900	866,25
1505805	B 180	48.000	36	1.550	300	34	41.200	1.144,50

Serie alta presión con bomba de engranajes. Combustión directa



B 360

Ref.	Código	Potencia Kcal/h	Capacidad depósito l	Caudal m3/h	Consumo W	Peso kg	Potencia W/h	€ / u.
1505851	B 230	56.000	65	3.000	800	72	65.000	2.198,70
1505852	B 360	95.460	111	3.300	1.060	105	111.000	2.419,20

Combustión indirecta



BV 77

BV 110

Ref.	Código	Potencia Kcal/h	Capacidad depósito l	Caudal m3/h	Consumo w	Ø boca salida mm	Ø chimenea mm	Peso kg	Potencia W/h	€ / u.
1505900	BV 77	17.200	36	1.550	300	230	120	37	20.000	1.311,45
1505901	BV 110	28.400	65	1.800	800	340	150	77	33.000	2.262,75
1505902	BV 170	40.400	65	1.800	800	340	150	84	47.000	2.493,75
1505903	BV 290	69.600	105	3.300	1.060	400	150	124	81.000	3.012,45

Gas propano - gas butano. Combustión directa.



BLP 33 M



BLP 103 ET

Encendido manual piezoeléctrico. No es posible control termostático.

Ref.	Código	Capacidad Kcal/h	Capacidad W/h	Caudal m3/h	Consumo eléctrico W	Peso kg	Presión bar	€ / u.
1505948	BLP 17 M	8,6-13.800	10-16.000	300	53	5,5	0,7	198,45
1505949	BLP 33 M	15-28.400	18-33.000	1.000	60	9	0,75-1,5	300,30
1505952	BLP 53 M	31-45.600	36-53.000	1.450	110	15	0,75-1,5	477,75
1505953	BLP 73 M	42-62.800	49-73.000	2.300	218	17	0,75-1,5	523,95

Encendido automático. Control termoestático opcional

Ref.	Código	Capacidad Kcal/h	Capacidad W/h	Caudal m3/h	Consumo eléctrico W	Peso kg	Presión bar	€ / u.
1505960	BLP 33 ET	15,5-28.400	18-33.000	1.000	74	9	0,75-1,5	463,05
1505961	BLP 53 ET	31-45.600	36-53.000	1.450	126	15	0,75-1,5	628,95
1505962	BLP 73 ET	42-62.800	49-73.000	2.300	230	17	0,75-1,5	757,05
1505963	BLP 103 ET	49-88.600	57-103.000	3.260	230	27,5	0,75-2	1.123,50

Eléctrico por aire o radiación. Por aire



B 5/B 9/B 15/B 22



B-18 EPR + Conducto opcional



RS-30/40



Hall 3000

Eléctricos por aire

Ref.	Código	Potencia kW	Caudal m3/h	Etapas trabajo	Peso kg	Potencia Kcal/h	Resistencia blindada	Tensión V	€ / u.
1506000	B 3,3	1,65 - 3,3	510	2+vent.	5,7	2.860	IP-24	230/1/50	135,45
1506001	B 5EPB	2,5 - 5	510	2+vent.	6,8	4.300	IP-24	400/3/50	197,40
1506002	B 9EPB	4,5 - 9	800	2+vent.	10,3	7.740	IP-24	400/3/50	253,05
1506003	B 15EPB	7,5 - 15	1.700	2+vent.	15,9	12.900	IP-24	400/3/50	434,70
1506004	B 22EPB	11 - 22	2.400	2+vent.	22,8	18.900	IP-24	400/3/50	694,05
1506005	B-18 EPR	9-18	1.700	2+vent.	29,3	15.480	IP-24	400/3/50	916,65
1506010	B-30 EPR	15-30	3.500	2+vent.	63	25.800	IP-24	400/3/50	1.874,25
1506012	RS-40	13-26-40	3.100	3+vent.	52	34.400	IP-20	400/3/50	2.003,40

Eléctricos por radiación

Ref.	Código	Potencia kW	Calor por	Consumo máx. amp.	Etapas trabajo	Peso kg	Potencia Kcal/h	Tensión V	€ / u.
1506050	TS-3A	0,8 - 1,6 - 2,4	infrarrojo onda larga	10,5	3	8	2.070	230/1/50	429,45
1506051	Hall 1500	1,5	infrarrojo onda corta	6,5	1	6	1.290	230/1/50	344,40
1506052	Hall 3000	1,5 - 3	infrarrojo onda corta	13	2	8	2.580	230/1/50	624,75

Gasóleo. Combustión directa



XL 61



XL 91

Ref.	Código	Capacidad W/h	Capacidad depósito l	Capacidad Kcal/h	Consumo A/h	Consumo W	Peso kg	€ / u.
1506099	XL 61	17.000	11	14.600	0.85	200	21	1.046,85
1506100	XL 91	43.000 / 29.000	60	37.000 / 25.000	0.7	160	85	2.578,80
1506101	XL 9SR 2V	43.000 / 29.000	60	37.000 / 25.000	0.7	190	85	2.917,95

Deshumidificador Industrial



DH-752



DHP-45/65



DH-26/44/62/92

Ref.	Código	Capacidad 32°C-80% HR	Capacidad depósito l	Caudal de aire m3/h	Consumo máx. kW	Gas refrigerante	Peso kg	Temperatura de trabajo °C	Volumen m3 a tratar	€ / u.
1506157	DH-720	20 l/24 h	5	150	390	R-134A	12	5-32	50	628,95
1506159	DH-721	20 l/24 h	4,7	240	490	R-134A	21	5-35	390	771,75
1506160	DH-732	30 l/24 h	6,5	160	680	R-410A	21	5-32	450	1.038,45
1506161	DH-752	47 l/24 h	5,7	350	900	R-410A	36	5-35	701	1.727,25
1506162	DH-792	72 l/24 h	15	850	1.790	R-407C	64	5-32	1.080	2.955,75
1506150	DH-26	27 l/24 h	8	350	620	R-410A	33	0,5 - 35	405	1.412,25
1506151	DH-44	41 l/24 h	11	480	780	R-410A	47	3 - 35	615	1.992,90
1506152	DH-62	52 l/24 h	11	480	990	R-410A	51	3 - 35	780	2.148,30
1506153	DH-92	80 l/24 h	11	1.000	1.600	R-410A	70	3 - 35	1.200	2.928,45
1506155	DHP-65	56 l/24 h	10,5	500	780	R-410A	50	3 - 35	840	2.147,25



380

Brocas mango
cilíndrico cortas



397

Machos de
mano



420

Fresas
huecas



384

Brocas mango
cilíndrico multi inox



399

Cojinetes



420

Plaquitas

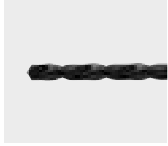

386

Brocas mango
cilíndrico largas



400

Giramachos



441

Casquillos



387

Brocas mango
cilíndrico extra largas



401

Machos de
máquina



444

Sierras de
cinta



387

Brocas mango
cilíndrico extra cortas



405

Reparadores
de roscas



444

Arcos de
sierra

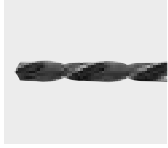

390

Brocas mango
cónico



406

Fresas
rotativas



447

Serruchos



391

Brocas de
centrar



413

Fresas 1Z



449

Coronas Hss

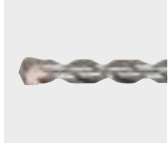

391

Brocas de
pared



415

Fresas 2Z

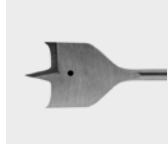

395

Brocas para
madera



416

Fresas 3Z



396

Escariadores

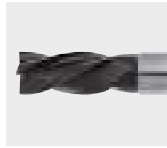

417

Fresas NZ

HERRAMIENTA DE CORTE

03

03

A close-up photograph of a metal cutting tool, possibly a part of a CNC machine or a specialized cutting device. The tool features a cylindrical metal body with a braided hose or cable attached to its side. The background is a solid, vibrant magenta color, which is also used for the text on the page.

1010 Bronca mango cilíndrico uso general

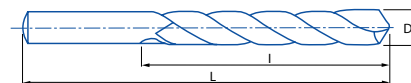

HSS	HSS + TIN	DIN 338 N	118°			Blue Finish	Rectificado Ground Taillé Meulé	Tol. D h8
-----	-----------	-----------	------	--	--	-------------	------------------------------------	--------------

Ref. HSS	Código HSS	€/ u. HSS	Ref. TIN	Código TIN	€/ u. TIN	Ø h8 mm	l mm	L mm	Ref. HSS	Código HSS	€/ u. HSS	Ref. TIN	Código TIN	€/ u. TIN	Ø h8 mm	l mm	L mm
100006	18008	1,42				0,50	6	22	100121	10190	2,00	100369	18467	5,26	6,25	63	101
100008	18014	1,79				0,60	7	24	100122	10193	2,21	100370	27324	5,34	6,30	63	101
100010	18020	1,79				0,70	9	28	100124	10196	2,29	100371	18470	5,43	6,40	63	101
100011	18023	1,31				0,75	9	28	100126	10199	1,72	100372	18473	5,02	6,50	63	101
100012	18026	1,34				0,80	10	30	100128	10202	2,77	100373	18476	5,86	6,60	63	101
100014	18032	1,34				0,90	11	32	100130	10205	2,77	100374	27333	5,86	6,70	63	101
100016	10001	1,04	100306	18305	2,08	1,00	12	34	100131	10208	2,08	100375	18479	5,36	6,75	69	109
100018	10004	1,15	100307	15056	2,10	1,10	14	36	100132	10211	2,08	100376	18482	5,36	6,80	69	109
100020	10007	1,15	100308	18308	2,10	1,20	16	38	100134	10214	3,06	100377	18485	6,12	6,90	69	109
100021	10010	0,92	100309	27087	1,95	1,25	16	38	100136	10217	2,08	100378	18488	5,36	7,00	69	109
100022	10013	1,02	100310	18311	2,02	1,30	16	38	100138	10220	3,22	100379	18491	6,31	7,10	69	109
100024	10016	1,02	100311	27337	2,02	1,40	18	40	100140	10223	3,22	100380	18494	6,31	7,20	69	109
100026	10019	0,79	100312	18314	1,78	1,50	18	40	100141	10226	2,66	100381	18497	5,88	7,25	69	109
100028	10022	0,98	100313	18317	1,99	1,60	20	43	100142	10229	3,22	100382	18500	6,31	7,30	69	109
100030	10025	0,98	100314	18320	1,99	1,70	20	43	100144	10232	3,22	100383	27150	6,31	7,40	69	109
100031	10028	0,88	100315	18323	1,94	1,75	22	46	100146	10235	2,20	100384	18503	5,48	7,50	69	109
100032	10031	0,88	100316	18326	1,90	1,80	22	46	100148	10238	3,83	100385	27313	6,91	7,60	75	117
100034	10034	0,88	100317	18329	1,90	1,90	22	46	100150	10241	3,83	100386	18506	6,91	7,70	75	117
100036	10037	0,75	100318	18332	1,78	2,00	24	49	100151	10244	2,97	100387	27272	6,25	7,75	75	117
100038	10040	0,77	100319	18335	1,71	2,10	24	49	100152	10247	3,87	100388	18509	6,93	7,80	75	117
100040	10043	0,77	100320	18338	1,71	2,20	27	53	100154	10250	3,87	100389	18512	6,93	7,90	75	117
100041	10046	0,72	100321	18341	1,66	2,25	27	53	100156	10253	2,52	100390	18515	5,77	8,00	75	117
100042	10049	0,91	100322	18344	1,83	2,30	27	53	100158	10256	3,96	100391	26675	7,58	8,10	75	117
100044	10052	0,91	100323	18347	1,83	2,40	30	57	100160	10259	3,96	100392	26678	7,58	8,20	75	117
100046	10055	0,75	100324	18350	1,72	2,50	30	57	100161	10262	2,97	100393	18518	6,83	8,25	75	117
100048	10058	0,93	100325	18353	1,84	2,60	30	57	100162	10265	4,12	100394	27311	7,74	8,30	75	117
100050	10061	0,93	100326	27166	1,84	2,70	33	61	100164	10268	4,12	100395	26681	7,74	8,40	75	117
100051	10064	0,79	100327	18356	1,78	2,75	33	61	100166	10271	2,73	100396	18521	6,53	8,50	75	117
100052	10067	0,93	100328	18359	1,84	2,80	33	61	100168	10274	5,17	100397	18524	8,71	8,60	81	125
100054	10070	0,93	100329	27088	1,84	2,90	33	61	100170	10277	5,17	100398	18527	8,71	8,70	81	125
100056	10073	0,68	100330	18362	1,61	3,00	33	61	100171	10280	3,98	100399	18530	7,75	8,75	81	125
100058	10076	0,79	100331	18365	2,05	3,10	36	65	100172	10283	5,19	100400	18533	8,72	8,80	81	125
100060	10079	0,79	100332	18368	2,05	3,20	36	65	100174	10286	5,19	100401	18536	8,72	8,90	81	125
100061	10082	0,79	100333	18371	2,05	3,25	36	65	100176	10289	3,34	100402	18539	7,06	9,00	81	125
100062	10085	0,79	100334	18374	2,05	3,30	36	65	100178	10292	5,22	100403	26684	8,76	9,10	81	125
100064	10088	1,03	100335	27322	2,19	3,40	39	70	100180	10295	5,22	100404	27553	8,76	9,20	81	125
100066	10091	0,77	100336	18377	2,01	3,50	39	70	100181	10298	4,01	100405	27273	7,79	9,25	81	125
100068	10094	1,06	100337	27323	2,22	3,60	39	70	100182	10301	4,89	100406	18542	8,45	9,30	81	125
100070	10097	1,06	100338	18380	2,22	3,70	39	70	100183	10304	4,89	100407	27149	8,45	9,40	81	125
100071	10100	0,91	100339	18383	2,14	3,75	39	70	100185	10307	3,63	100408	18545	7,35	9,50	81	125
100072	10103	1,09	100340	18386	2,25	3,80	43	75	100187	10310	6,23	100409	26687	9,70	9,60	87	133
100074	10106	1,09	100341	27165	2,25	3,90	43	75	100189	10313	6,23	100410	27151	9,70	9,70	87	133
100076	10109	0,89	100342	18389	2,11	4,00	43	75	100190	10316	4,52	100411	18548	8,27	9,75	87	133
100078	10112	0,98	100343	18392	2,19	4,10	43	75	100191	10319	6,13	100412	18551	9,60	9,80	87	133
100080	10115	0,98	100344	18395	2,19	4,20	43	75	100193	10322	6,13	100413	18554	9,60	9,90	87	133
100081	10118	0,98	100345	18398	2,19	4,25	43	75	100195	10325	3,89	100414	18557	7,62	10,00	87	133
100082	10121	1,30	100346	18401	2,43	4,30	47	80	100198	10328	5,44	100415	27274	13,48	10,25	87	133
100084	10124	1,30	100347	18404	2,43	4,40	47	80				100416	29151	13,78	10,30	87	133
100086	10127	1,02	100348	18407	2,23	4,50	47	80	100201	10343	4,87	100417	18563	12,62	10,50	87	133
100088	10130	1,31	100349	18410	2,45	4,60	47	80				100418	29154	14,00	10,60	87	133
100090	10133	1,31	100350	18413	2,45	4,70	47	80	100204	10352	6,30	100419	27277	13,94	10,75	94	142
100091	10136	1,15	100351	18416	2,35	4,75	47	80				100420	29157	14,69	10,80	94	142
100092	10139	1,46	100352	18419	2,59	4,80	52	86	100207	10361	5,68	100421	18566	13,36	11,00	94	142
100094	10142	1,43	100353	18422	2,55	4,90	52	86	100210	10370	6,43	100422	26801	14,05	11,25	94	142
100096	10145	1,08	100354	18425	2,27	5,00	52	86	100213	10379	6,07	100423	18569	13,72	11,50	94	142
100098	10148	1,47	100355	18428	2,58	5,10	52	86	100216	10388	6,43	100424	27275	14,05	11,75	94	142
100100	10151	1,47	100356	18431	2,58	5,20	52	86	100219	10397	6,75	100425	18572	14,36	12,00	101	151
100101	10154	1,38	100357	18434	2,57	5,25	52	86				100426	29169	18,57	12,10	101	151
100102	10157	1,82	100358	18437	2,92	5,30	52	86	100222	10406	8,37	100427	18578	17,92	12,25	101	151
100104	10160	1,82	100359	27292	2,92	5,40	57	93	100225	10415	7,43	100428	18581	17,01	12,50	101	151
100106	10163	1,44	100360	18440	2,63	5,50	57	93	100228	10424	8,25	100429	27276	17,80	12,75	101	151
100108	10166	1,95	100361	18443	3,04	5,60	57	93	100231	10433	7,68	100430	18584	17,28	13,00	101	151
100110	10169	1,95	100362	18446	3,04	5,70	57	93	100234	10439	12,06	100431	29180	22,16	13,25	108	160
100111	10172	1,86	100363	18449	3,03	5,75	57	93	100237	10442	10,88	100432	29184	21,05	13,50	108	160
100112	10175	1,82	100364	18452	2,92	5,80	57	93	100243	10454	11,65	100433	29007	21,79	14,00	108	160
100114	10178	1,82	100365	18455	2,92	5,90	57	93	100246	10457	13,67	100434	29194	23,64	14,25	114	169
100116	10181	1,49	100366	18458	2,65	6,00	57	93	100249	10460	12,57	100435	29198	22,59	14,50	114	169
100118	10184	2,10	100367	18461	5,26	6,10	63	101	100252	10463	13,67	100436	29202	23,64	14,75	114	169
100120	10187	2,10	100368	18464	5,26	6,20	63	101	100255	10466	12,70	100437	29205				

Ref. HSS	Código HSS	€/u. HSS	Ref. TIN	Código TIN	€/u. TIN	Ø h8 mm	l mm	L mm
100257	10469	18,64	100438	29209	28,26	15,25	120	178
100258	10472	14,86	100439	29213	24,77	15,50	120	178
100264	10478	15,47	100440	29220	25,32	16,00	120	178
100266	10481	27,84				16,25	125	184
100267	10484	18,00				16,50	125	184
100268	10487	29,10				16,75	125	184
100270	10490	18,00				17,00	125	184
100271	10493	30,21				17,25	130	191
100272	10496	20,69				17,50	130	191
100273	10499	33,45				17,75	130	191

Ref. HSS	Código HSS	€/u. HSS	Ref. TIN	Código TIN	€/u. TIN	Ø h8 mm	l mm	L mm
100274	10502	21,88				18,00	130	191
100275	10505	32,81				18,25	135	198
100276	10508	24,30				18,50	135	198
100277	10511	33,74				18,75	135	198
100278	10514	24,30				19,00	135	198
100279	10517	44,16				19,25	140	205
100280	10520	26,05				19,50	140	205
100281	10523	42,83				19,75	140	205
100282	10526	29,68				20,00	140	205

1013 Broca aguzada mango cilíndrico HSS

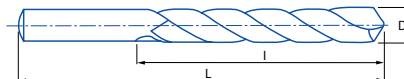

HSS	DIN 338 N			DIN 1412 C ≥ 2 mm		Blanca Bright Finish Finition Blanc	Rectificado Ground Taillé Meulé	Chapa Sheets Tôle < 5 mm	Tol. D h8
-----	-----------	--	--	-------------------	--	-------------------------------------	---------------------------------	--------------------------	-----------

Ref. HSS	Código HSS	l mm	L mm	Ø h8 mm	€/u.
100800	17673	12	34	1,00	1,17
100801	10650	14	36	1,10	1,30
100802	10656	16	38	1,20	1,30
100803	10662	16	38	1,30	1,14
100804	10663	18	40	1,40	1,14
100805	10666	18	40	1,50	0,88
100806	10669	20	43	1,60	1,08
100807	10670	20	43	1,70	1,08
100808	10672	22	46	1,80	0,97
100809	10674	22	46	1,90	0,97
100810	10675	24	49	2,00	0,82
100811	10677	24	49	2,10	0,88
100813	10679	27	53	2,25	0,79
100815	10683	30	57	2,40	1,03
100816	10684	30	57	2,50	0,84
100817	10685	30	57	2,60	1,04
100818	10686	33	61	2,70	1,04
100819	10687	33	61	2,75	0,89
100820	10690	33	61	2,80	1,04
100821	10692	33	61	2,90	1,04
100822	10693	33	61	3,00	0,75
100823	10695	36	65	3,10	0,89
100824	10696	36	65	3,20	0,89
100825	10698	36	65	3,25	0,89
100826	10699	36	65	3,30	0,89
100827	10701	39	70	3,40	1,13
100828	10702	39	70	3,50	0,88
100829	10704	39	70	3,60	1,17
100830	10705	39	70	3,70	1,17
100831	10708	39	70	3,75	1,03
100832	10710	43	75	3,80	1,25
100833	10719	43	75	3,90	1,25
100834	10770	43	75	4,00	0,98
100835	10774	43	75	4,10	1,09
100836	10776	43	75	4,20	1,09
100837	10777	43	75	4,25	1,09
100838	10779	47	80	4,30	1,46
100839	10780	47	80	4,40	1,46
100840	10782	47	80	4,50	1,12
100841	10783	47	80	4,60	1,49
100842	10786	47	80	4,70	1,49
100843	10787	47	80	4,75	1,32
100844	10789	52	86	4,80	1,63
100845	10792	52	86	4,90	1,60
100846	10793	52	86	5,00	1,23
100847	10795	52	86	5,10	1,64
100848	10797	52	86	5,20	1,64
100849	10798	52	86	5,25	1,58
100850	10799	52	86	5,30	2,05
100851	10800	57	93	5,40	2,05
8000148	10671	22	46	1,75	0,98
100852	10801	57	93	5,50	1,62
100853	10802	57	93	5,60	2,15
100854	10804	57	93	5,70	2,15
100855	10807	57	93	5,75	2,11
100856	10808	57	93	5,80	2,05
100857	10810	57	93	5,90	2,05
100858	10811	57	93	6,00	1,65
100859	10813	63	101	6,10	2,37

Ref. HSS	Código HSS	l mm	L mm	Ø h8 mm	€/u.
100860	10814	63	101	6,20	2,37
100861	10815	63	101	6,25	2,21
100862	10816	63	101	6,30	2,50
100863	10819	63	101	6,40	2,53
100864	10822	63	101	6,50	1,95
100865	11145	63	101	6,60	3,12
100866	11154	63	101	6,70	3,12
100867	11157	69	109	6,75	2,36
100868	11163	69	109	6,80	2,36
100869	11166	69	109	6,90	3,42
100870	11172	69	109	7,00	2,36
100871	11175	69	109	7,10	3,64
100872	13066	69	109	7,20	3,64
100873	11184	69	109	7,25	2,98
100874	11190	69	109	7,30	3,64
100875	11202	69	109	7,40	3,64
100876	11217	69	109	7,50	2,47
100878	11226	75	117	7,70	4,31
100879	11229	75	117	7,75	3,32
100880	11230	75	117	7,80	4,34
100881	11251	75	117	7,90	4,34
100882	11268	75	117	8,00	2,83
100883	11269	75	117	8,10	4,42
100884	11287	75	117	8,20	4,42
100885	11290	75	117	8,25	3,32
100886	11297	75	117	8,30	4,62
100887	11302	75	117	8,40	4,62
100888	11303	75	117	8,50	3,06
100889	11304	81	125	8,60	5,81
100890	11305	81	125	8,70	5,81
100891	11306	81	125	8,75	4,45
100892	11307	81	125	8,80	5,83
100893	11308	81	125	8,90	5,83
100894	11310	81	125	9,00	3,74
100897	11313	81	125	9,25	4,51
100900	11317	81	125	9,50	4,05
100901	11318	87	133	9,60	6,99
100903	11321	87	133	9,75	5,10
100904	11322	87	133	9,80	6,89
100905	11323	87	133	9,90	6,89
100906	11324	87	133	10,00	4,36
100907	22341	87	133	10,10	5,86
100908	17648	87	133	10,20	5,44
100909	17506	87	133	10,30	6,84
100910	17613	87	133	10,50	5,44
100911	22342	94	142	10,70	7,50
100912	13783	94	142	11,00	6,37
100913	17609	94	142	11,50	6,80
100914	19657	94	142	11,70	8,34
100915	17611	101	151	12,00	7,57
100916	22343	101	151	12,30	10,01
100917	17615	101	151	12,50	8,30
100918	17081	101	151	12,70	10,42
100919	16556	101	151	13,00	8,60
100920	22833	108	160	13,50	12,20
100921	19224	108	160	14,00	13,08
100922	24941	114	169	14,50	14,06
100923	19227	114	169	15,00	14,23
100924	22306	120	178	16,00	17,35

03



1016 Broca mango cilíndrico materiales duros HSSE



PROFESSIONAL

HSSE 5%Co	DIN 338 N	135°		DIN 1412 C ≥ 2 mm		Ambar Gold Finish Finition Or	Rectificado Ground Taillé Meulé	A.R.I.* * Alto Rendimiento Intensivo I.H.P.* * Intensive High Performance H.P.I.* * Haute Performance Intensif	Tol. D h8
--------------	--------------	------	--	-------------------------	--	-------------------------------------	---------------------------------------	--	--------------

Ref. HSSE	Código HSSE	Ø h8 mm	l mm	L mm	€/ u.	Ref. HSSE	Código HSSE	Ø h8 mm	l mm	L mm	€/ u.
101200	27309	1	12	34	1,45	101263	20433	6,25	63	101	3,15
101201	20107	1,1	14	36	1,79	101264	20442	6,3	63	101	3,34
101202	28861	1,2	16	38	1,78	101265	20451	6,4	63	101	3,34
101203	20112	1,25	16	38	1,72	101266	27290	6,5	63	101	3,22
101204	20116	1,3	16	38	1,78	101267	20466	6,6	63	101	4,01
101205	20125	1,4	18	40	1,78	101268	20475	6,7	63	101	4,01
101206	27170	1,5	18	40	1,40	101269	20481	6,75	69	109	3,77
101207	20133	1,6	20	43	1,78	101270	20488	6,8	69	109	3,77
101208	20142	1,7	20	43	1,78	101271	20493	6,9	69	109	4,01
101209	20146	1,75	22	46	1,72	101272	19305	7	69	109	3,52
101210	20151	1,8	22	46	1,78	101273	20499	7,1	69	109	5,10
101211	20155	1,9	22	46	1,78	101274	20503	7,2	69	109	5,10
101212	19247	2	24	49	1,44	101275	20508	7,25	69	109	4,79
101213	20161	2,1	24	49	1,70	101276	20512	7,3	69	109	5,10
101214	20166	2,2	27	53	1,70	101277	20517	7,4	69	109	5,10
101215	20170	2,25	27	53	1,63	101278	19292	7,5	69	109	3,77
101216	20175	2,3	27	53	1,70	101279	20523	7,6	75	117	6,16
101217	20184	2,4	30	57	1,70	101280	20527	7,7	75	117	6,16
101218	19251	2,5	30	57	1,32	101281	20532	7,75	75	117	5,81
101219	20199	2,6	30	57	1,65	101282	20536	7,8	75	117	6,16
101220	20203	2,7	33	61	1,65	101283	20541	7,9	75	117	6,16
101221	19262	2,75	33	61	1,63	101284	20208	8	75	117	4,41
101222	20209	2,8	33	61	1,65	101285	22734	8,1	75	117	5,87
101223	20214	2,9	33	61	1,65	101286	22737	8,2	75	117	5,87
101224	19256	3	33	61	1,30	101287	22740	8,25	75	117	5,54
101225	20220	3,1	36	65	1,58	101288	22743	8,3	75	117	5,87
101226	20224	3,2	36	65	1,58	101289	22746	8,4	75	117	5,87
101227	19259	3,25	36	65	1,58	101290	19298	8,5	75	117	4,57
101228	20230	3,3	36	65	1,58	101291	22752	8,6	81	125	7,48
101229	20235	3,4	39	70	1,65	101292	22755	8,7	81	125	7,48
101230	19268	3,5	39	70	1,57	101293	22758	8,75	81	125	7,07
101231	20241	3,6	39	70	1,98	101294	22761	8,8	81	125	7,48
101232	20245	3,7	39	70	1,98	101295	22764	8,9	81	125	7,48
101233	19269	3,75	39	70	1,84	101296	20358	9	81	125	5,84
101234	20251	3,8	43	75	1,98	101297	22768	9,1	81	125	8,29
101235	20256	3,9	43	75	1,98	101298	22771	9,2	81	125	8,29
101236	19286	4	43	75	1,66	101299	22774	9,25	81	125	7,80
101237	20265	4,1	43	75	1,84	101300	22777	9,3	81	125	8,29
101238	20269	4,2	43	75	1,84	101301	22780	9,4	81	125	8,29
101239	19271	4,25	43	75	1,84	101302	20545	9,5	81	125	6,07
101240	20278	4,3	47	80	1,98	101303	22784	9,6	87	133	9,75
101241	20283	4,4	47	80	1,98	101304	23567	9,7	87	133	9,75
101242	19274	4,5	47	80	1,92	101305	26697	9,75	87	133	9,20
101243	20289	4,6	47	80	2,19	101306	26809	9,8	87	133	9,75
101244	20293	4,7	47	80	2,19	101307	27121	9,9	87	133	9,75
101245	20298	4,75	47	80	2,07	101308	27291	10	87	133	6,67
101246	20302	4,8	52	86	2,19	101309	27318	10,1	87	133	11,20
101247	20311	4,9	52	86	2,19	101310	27541	10,2	87	133	9,45
101248	19277	5	52	86	2,00	101311	27544	10,25	87	133	11,62
101249	20320	5,1	52	86	2,38	101312	27585	10,3	87	133	11,20
101250	20328	5,2	52	86	2,38	101313	27682	10,4	87	133	11,20
101251	19280	5,25	52	86	2,36	101314	27685	10,5	87	133	9,45
101252	20340	5,3	52	86	2,38	101315	27690	10,6	94	142	13,03
101253	20349	5,4	57	93	2,38	101316	27693	10,7	94	142	13,03
101254	19290	5,5	57	93	2,52	101317	27696	10,75	94	142	13,51
101255	20361	5,6	57	93	3,01	101318	27699	10,8	94	142	13,03
101256	20370	5,7	57	93	3,01	101319	27702	10,9	94	142	13,03
101257	20379	5,75	57	93	2,84	101320	27705	11	94	142	10,43
101258	20388	5,8	57	93	3,01	101321	27708	11,1	94	142	14,82
101259	20397	5,9	57	93	3,01	101322	27711	11,2	94	142	14,82
101260	19301	6	57	93	2,71	101323	27714	11,25	94	142	15,39
101261	20415	6,1	63	101	3,34	101324	27717	11,3	94	142	14,82
101262	20424	6,2	63	101	3,34	101325	27720	11,4	94	142	14,82





1016 Broca mango cilíndrico materiales duros HSSE

Ref. HSSE	Código HSSE	Ø h8 mm	l mm	L mm	€/ u.
101326	19307	11,5	94	142	12,47
101327	27724	11,6	94	142	15,33
101328	27727	11,7	94	142	15,33
101329	27730	11,75	94	142	15,91
101330	27733	11,8	94	142	15,33
101331	27736	11,9	101	151	15,33
101332	19311	12	101	151	13,33
101333	27742	12,1	101	151	17,78
101334	27745	12,2	101	151	17,78
101335	19313	12,25	101	151	18,45
101336	27749	12,3	101	151	17,78
101337	27752	12,4	101	151	17,78
101338	27755	12,5	101	151	16,24
101339	27758	12,6	101	151	18,55
101340	27761	12,7	101	151	18,55
101341	19316	12,75	101	151	19,28
101342	27765	12,8	101	151	18,55
101343	27768	12,9	101	151	18,55
101344	27771	13	101	151	16,63
101345	27777	13,25	108	160	22,98

Ref. HSSE	Código HSSE	Ø h8 mm	l mm	L mm	€/ u.
101346	27774	13,5	108	160	18,31
101347	27780	13,75	108	160	22,98
101348	27783	14	108	160	18,12
101349	27786	14,25	114	169	30,22
101350	27789	14,5	114	169	25,68
101351	27792	14,75	114	169	30,22
101352	27795	15	114	169	26,08
101353	27798	15,25	120	178	41,70
101354	27801	15,5	120	178	30,19
101355	27804	15,75	120	178	41,70
101356	27807	16	120	178	31,28
101357	27811	16,5	125	184	35,74
101358	27814	17	125	184	35,74
101359	27817	17,5	130	191	39,62
101360	27820	18	130	191	43,14
101361	27823	18,5	135	198	47,66
101362	27826	19	135	198	47,66
101363	27829	19,5	140	205	52,83
101364	27832	20	140	205	56,60

03

1020 Broca mango cilíndrico inox HSSE

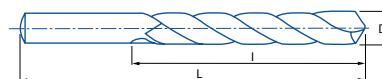

SPEED MAX

HSSE 5%Co	DIN 338 W	135°	40°	DIN 1412 C ≥ 2 mm	< 5 mm	Chapa Sheets Tôle	Blanca Bright Finish Finition Blanc	Tol. D h8
-----------	-----------	------	-----	-------------------	--------	-------------------	-------------------------------------	-----------

Ref. HSSE	Código HSSE	l mm	L mm	Ø h8 mm	€/ u.
101600	14115	12	34	1,00	2,14
101601	14116	16	38	1,25	2,53
101602	14117	18	40	1,50	2,03
101603	21615	24	49	2,00	2,03
101604	21616	27	53	2,25	2,24
101605	21618	30	57	2,50	1,84
101606	21625	33	61	2,75	2,24
101607	12964	33	61	2,80	2,42
101608	16283	33	61	3,00	1,81
101609	17970	36	65	3,10	2,22
101610	16284	36	65	3,20	2,22
101611	16285	36	65	3,25	2,22
101612	16286	36	65	3,30	2,22
101613	16287	39	70	3,50	2,20
101614	14120	39	70	3,70	2,90
101615	16288	39	70	3,75	2,63
101616	12507	43	75	3,80	2,90
101617	16289	43	75	4,00	2,36
101618	16290	43	75	4,10	2,63
101619	16291	43	75	4,20	2,63
101620	16292	43	75	4,25	2,63
101621	14122	47	80	4,30	2,90
101622	16293	47	80	4,50	2,63
101623	16294	47	80	4,75	2,93
101624	14123	52	86	4,80	3,23
101625	16295	52	86	5,00	2,83
101626	16296	52	86	5,10	3,34
101627	28626	52	86	5,20	3,49
101628	16297	52	86	5,25	3,30
101629	16298	57	93	5,50	3,57
101630	25134	57	93	5,70	4,40
101631	16299	57	93	5,75	3,98

Ref. HSSE	Código HSSE	l mm	L mm	Ø h8 mm	€/ u.
101632	16302	57	93	6,00	3,79
101633	21627	63	101	6,25	4,36
101634	16304	63	101	6,50	4,42
101635	21628	69	109	6,75	5,20
101636	16306	69	109	6,80	5,20
101637	16307	69	109	7,00	4,83
101638	21631	69	109	7,25	6,62
101639	16309	69	109	7,50	5,16
8000154	69940	75	117	7,75	7,95
101640	16311	75	117	8,00	6,03
101641	21633	75	117	8,25	7,65
101642	16313	75	117	8,50	6,30
8000155	69938	81	125	8,75	9,65
101643	16314	81	125	9,00	8,00
8000156	69937	81	125	9,25	10,68
101644	16316	81	125	9,50	8,30
8000157	69935	87	133	9,75	12,58
101645	16318	87	133	10,00	9,16
8000158	14248	87	133	10,2	12,34
101646	21634	87	133	10,25	16,07
101647	16320	87	133	10,50	12,34
8000159	69934	94	142	10,75	17,71
101648	16321	94	142	11,00	13,63
8000160	69932	94	142	11,25	19,42
101649	16322	94	142	11,50	15,68
8000161	69931	94	142	11,75	20,09
101650	16323	101	151	12,00	16,82
8000162	69929	101	151	12,25	21,31
101651	16324	101	151	12,50	18,72
8000163	69928	101	151	12,75	22,27
101652	16325	101	151	13,00	18,99



1021 Broca mango cilíndrico multi inox HSSE

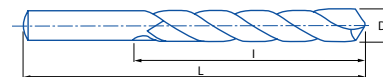

BOROA

HSSE 5%Co	DIN 338 W	135°	40°		DIN 1412 C ≥ 2 mm		≥Ø4		Chapa Sheets Tôle < 5 mm	Blue+ Gold Finish ≥ 3 mm	Tol. D h8
--------------	--------------	------	-----	--	-------------------------	--	-----	--	-----------------------------------	--------------------------------	--------------

Ref. HSSE	Código HSSE	l mm	L mm	Ø h8 mm	€ / u.	Ref. HSSE	Código HSSE	l mm	L mm	Ø h8 mm	€ / u.
146300	25645	24	49	2,00	2,53	8000172	25803	69	109	7,25	8,29
8000164	25646	27	53	2,25	2,79	146317	25805	69	109	7,50	6,43
146301	25647	30	57	2,50	2,31	8000173	69952	75	117	7,75	9,95
8000165	25648	33	61	2,75	2,79	146318	25807	75	117	8,00	7,52
146302	25650	33	61	3,00	2,25	8000174	25809	75	117	8,25	9,57
146303	25710	36	65	3,20	2,77	146319	25811	75	117	8,50	7,86
146304	25728	36	65	3,25	2,77	8000175	69950	81	125	8,75	12,06
146305	25730	36	65	3,30	2,77	146320	25813	81	125	9,00	10,00
146306	25733	39	70	3,50	2,72	8000176	69949	81	125	9,25	13,34
8000166	25738	39	70	3,75	3,29	146321	25815	81	125	9,50	10,35
146307	25744	43	75	4,00	2,96	8000177	69947	87	133	9,75	15,73
146308	25751	43	75	4,20	3,29	146322	25817	87	133	10,00	11,43
146309	25756	43	75	4,25	3,29	146323	32666	87	133	10,20	15,41
146310	25762	47	80	4,50	3,29	8000178	25819	87	133	10,25	20,09
8000167	25764	47	80	4,75	3,66	146324	25821	87	133	10,50	15,41
146311	25769	52	86	5,00	3,52	8000179	69946	94	142	10,75	22,15
8000168	25777	52	86	5,25	4,12	146325	25823	94	142	11,00	17,01
146312	25780	57	93	5,50	4,45	8000180	69945	94	142	11,25	24,26
8000169	25786	57	93	5,75	4,97	146326	25825	94	142	11,50	19,57
146313	25788	57	93	6,00	4,75	8000181	69944	94	142	11,75	25,12
8000170	25790	63	101	6,25	5,45	146327	25827	101	151	12,00	20,98
146314	25793	63	101	6,50	5,54	8000182	69943	101	151	12,25	26,65
8000171	25795	69	109	6,75	6,51	146328	25829	101	151	12,50	23,35
146315	25798	69	109	6,80	6,49	8000183	69941	101	151	12,75	27,83
146316	25801	69	109	7,00	6,04	146329	25831	101	151	13,00	23,69

1466 Juego de brocas mango cilíndrico



Ref.	Código	Material	€ / u.
101900	25271	HSS	35,17
101901	25274	HSSE	59,72
101902	27132	TIN	75,42
101903	14748	TIALSIN	122,25
101904	18808	HSS	39,12
101905	24636	HSSE	81,79

Nº Piezas
19
Contenido
Ø 1 - 10 mm x 0,50



1456 Juego de brocas mango cilíndrico



Ref.	Código	Material	€ / u.
102000	25235	HSS	74,40
102001	18370	HSSE	139,02
102002	27133	TIN	164,52
102003	15378	TIALSIN	277,46
102004	18807	HSS	82,95
102005	24638	HSSE	178,72

Nº Piezas
25
Contenido
Ø 1 - 13 mm x 0,50



1007 Broca mango rebajado cilíndrico HSS

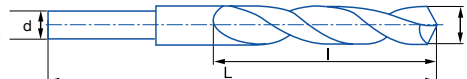

HSS	DIN 338 N	118°					Blue Finish	Rectificado Ground Taillé Meulé	30 mm	Tol. D h8
-----	-----------	------	--	--	--	--	-------------	------------------------------------	-------	-----------

Ref. HSS	Código HSS	l mm	L mm	Ø h8 mm	€/ u.
146400	15976	87	133	10,50	7,23
146401	15977	94	142	11,00	8,18
146402	15978	94	142	11,50	8,65
146403	15979	101	151	12,00	9,45
146404	15980	101	151	12,50	10,24
146405	15981	101	151	13,00	10,53
146406	15982	108	160	13,50	14,22
146407	15984	108	160	14,00	15,10
146408	15985	114	169	14,50	16,13
146409	15987	114	169	15,00	16,29
146410	15988	120	178	15,50	18,79
146411	15989	120	178	16,00	19,48
146412	15990	125	184	16,50	21,85
146413	15991	125	184	17,00	21,85
146414	15992	130	191	17,50	24,86

Ref. HSS	Código HSS	l mm	L mm	Ø h8 mm	€/ u.
146415	15993	130	191	18,00	26,18
146416	15994	135	198	18,50	28,89
146417	15995	135	198	19,00	28,89
146418	15996	140	205	19,50	31,48
146419	15997	140	205	20,00	36,26
8000184	66932	145	205	20,5	38,36
146420	17071	145	205	21,00	38,36
8000185	66933	150	210	21,5	42,29
146421	17072	150	210	22,00	42,29
8000186	66934	150	210	22,5	46,27
146422	36364	150	210	23,00	46,27
8000187	66935	160	220	23,5	51,07
146423	36365	160	220	24,00	51,07
8000188	66936	160	220	24,5	55,66
146424	36366	160	220	25,00	55,66

9100 Broca mango cilíndrico punta metal duro MD

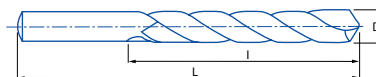

MD HM Carbure	DIN 338 N	118°			Rectificado Ground Taillé Meulé	Tol. D h7
---------------------	-----------	------	--	--	------------------------------------	-----------

Ref. MD	Código MD	l mm	L mm	Ø h8 mm	€/ u.
101700	71429	24	49	2,00	16,44
101701	71444	30	57	2,50	16,44
101702	71459	33	61	3,00	16,44
8000189	26716	36	65	3,3	16,93
101703	71474	39	70	3,50	16,93
101704	71489	43	75	4,00	16,93
8000190	22016	43	75	4,2	16,93
101705	71504	47	80	4,50	17,37
101706	71516	52	86	5,00	17,37
101707	71531	57	93	5,50	18,32
101708	71543	57	93	6,00	19,22
101709	71558	63	101	6,50	22,90
8000191	23893	69	109	6,8	22,91
101710	71573	69	109	7,00	22,91
101711	71585	69	109	7,50	23,81
101712	71600	75	117	8,00	23,81
101713	71615	75	117	8,50	25,98

Ref. MD	Código MD	l mm	L mm	Ø h8 mm	€/ u.
101714	71630	81	125	9,00	25,98
101715	71645	81	125	9,50	28,38
101716	71660	87	133	10,00	28,38
8000192	27008	87	133	10,2	36,57
101717	71663	87	133	10,50	36,57
101718	71666	94	142	11,00	36,57
101719	71672	94	142	11,50	42,05
101720	71675	101	151	12,00	42,05
101721	71681	101	151	12,50	50,33
101722	71684	101	151	13,00	50,33
101723	71690	108	160	14,00	58,56
101724	71696	114	169	15,00	66,77
101725	71702	120	178	16,00	76,87
101726	71705	125	184	17,00	84,17
101727	71711	130	191	18,00	90,59
101728	71717	135	198	19,00	112,54
101729	71723	140	205	20,00	128,09



03

1030 Broca mango cilíndrico larga HSS

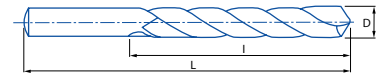

HSS	DIN 340 N	118°			Blue Finish	Rectificado Ground Taillé Meulé	Tol. D h8
-----	-----------	------	--	--	-------------	------------------------------------	-----------

Ref. HSS	Código HSS	Ø h8 mm	L mm	€ / u.	Ref. HSS	Código HSS	Ø h8 mm	L mm	€ / u.		
102700	26656	0,50	12	32	5,77	102779	11792	7,20	102	156	6,44
102701	26658	0,60	15	35	4,69	102780	11795	7,25	102	156	6,70
102702	19467	0,70	21	42	4,69	102781	11798	7,30	102	156	6,57
102703	24592	0,80	25	46	4,69	102782	11801	7,40	102	156	6,57
102704	26659	0,90	29	51	4,69	102783	11804	7,50	102	156	6,38
102705	11573	1,00	33	56	4,74	102784	11807	7,60	109	165	6,57
102706	11576	1,10	37	60	4,60	102785	11810	7,70	109	165	6,57
102707	11579	1,20	41	65	4,60	102786	11813	7,75	109	165	6,83
102708	11582	1,25	41	65	4,75	102787	11816	7,80	109	165	7,35
102709	11585	1,30	41	65	4,60	102788	11819	7,90	109	165	7,35
102710	11588	1,40	45	70	4,60	102789	11822	8,00	109	165	7,11
102711	11591	1,50	45	70	3,42	102790	11825	8,10	109	165	7,35
102712	11594	1,60	50	76	4,60	102791	11828	8,20	109	165	7,35
102713	11597	1,70	50	76	4,60	102792	11831	8,25	109	165	7,63
102714	11600	1,75	53	80	3,81	102793	11834	8,30	109	165	11,30
102715	11603	1,80	53	80	3,66	102794	11837	8,40	109	165	11,30
102716	11606	1,90	53	80	3,66	102795	11840	8,50	109	165	7,90
102717	11609	2,00	56	85	2,42	102796	11843	8,60	115	175	11,30
102718	11612	2,10	56	85	3,34	102797	11846	8,70	115	175	11,30
102719	11615	2,20	59	90	3,34	102798	11849	8,75	115	175	11,76
102720	11618	2,25	59	90	2,67	102799	11852	8,80	115	175	11,55
102721	11621	2,30	59	90	3,21	102800	11855	8,90	115	175	11,55
102722	11624	2,40	62	95	3,21	102801	11858	9,00	115	175	8,59
102723	11627	2,50	62	95	2,42	102802	11861	9,10	115	175	11,55
102724	11630	2,60	62	95	3,21	102803	11864	9,20	115	175	11,55
102725	11633	2,70	66	100	3,21	102804	11867	9,25	115	175	12,01
102726	11636	2,75	66	100	3,34	102805	11870	9,30	115	175	12,44
102727	11639	2,80	66	100	3,21	102806	11873	9,40	115	175	12,44
102728	11642	2,90	66	100	3,21	102807	11876	9,50	115	175	8,70
102729	11645	3,00	66	100	2,26	102808	11879	9,60	121	184	12,44
102730	11648	3,10	69	106	2,50	102809	11882	9,70	121	184	12,44
102731	11651	3,20	69	106	2,50	102810	11885	9,75	121	184	12,91
102732	11654	3,25	69	106	2,50	102811	11888	9,80	121	184	12,44
102733	11657	3,30	69	106	2,50	102812	11891	9,90	121	184	12,44
102734	11660	3,40	73	112	3,21	102813	11894	10,00	121	184	9,40
102735	11663	3,50	73	112	2,37	102814	11900	10,20	121	184	12,70
102736	11666	3,60	73	112	3,21	102815	11903	10,25	121	184	11,76
102737	11669	3,70	73	112	3,21	102816	11912	10,50	121	184	12,70
102738	11672	3,75	73	112	3,34	102817	11921	10,75	128	195	12,91
102739	11675	3,80	78	119	4,01	102818	11924	10,80	128	195	16,15
102740	11678	3,90	78	119	4,01	102819	11930	11,00	128	195	14,12
102741	11681	4,00	78	119	2,56	102820	11939	11,25	128	195	16,78
102742	11684	4,10	78	119	3,36	102821	11948	11,50	128	195	14,39
102743	11687	4,20	78	119	3,36	102822	11957	11,75	128	195	18,88
102744	11690	4,25	78	119	3,36	102823	11960	11,80	128	195	18,88
102745	11693	4,30	82	126	4,34	102824	11963	11,90	134	205	18,88
102746	11696	4,40	82	126	4,34	102825	11966	12,00	134	205	16,08
102747	11699	4,50	82	126	3,06	102826	11972	12,20	134	205	18,19
102748	11702	4,60	82	126	4,34	102827	11975	12,25	134	205	18,24
102749	19955	4,70	82	126	4,34	102828	11978	12,30	134	205	21,50
102750	11705	4,75	82	126	4,52	102829	11984	12,50	134	205	16,93
102751	11708	4,80	87	132	5,02	102830	11993	12,75	134	205	22,34
102752	11711	4,90	87	132	5,02	102831	12002	13,00	134	205	19,22
102753	11714	5,00	87	132	3,29	102832	12005	13,25	140	214	22,34
102754	11717	5,10	87	132	5,02	102833	12008	13,50	140	214	21,45
102755	11720	5,20	87	132	5,02	102834	12011	13,75	140	214	22,40
102756	11723	5,25	87	132	5,20	102835	12014	14,00	140	214	23,15
102757	11726	5,30	87	132	5,45	102836	12017	14,25	144	220	41,70
102758	11729	5,40	91	139	5,45	102837	12020	14,50	144	220	27,12
102759	11732	5,50	91	139	4,33	102838	12023	14,75	144	220	41,70
102760	11735	5,60	91	139	5,45	102839	12026	15,00	144	220	26,22
102761	11738	5,70	91	139	5,45	102840	12029	15,25	149	227	47,10
102762	11741	5,75	91	139	5,67	102841	12032	15,50	149	227	38,93
102763	11744	5,80	91	139	6,00	102842	12035	15,75	149	227	47,10
102764	11747	5,90	91	139	6,00	102843	12038	16,00	149	227	30,53
102765	11750	6,00	91	139	4,02	102844	12041	16,25	154	235	51,98
102766	11753	6,10	97	148	6,00	102845	12044	16,50	154	235	36,11
102767	11756	6,20	97	148	6,00	102846	12047	16,75	154	235	51,98
102768	11759	6,25	97	148	6,22	102847	12050	17,00	154	235	36,28
102769	11762	6,30	97	148	6,07	102848	12053	17,25	158	235	59,76
102770	11765	6,40	97	148	6,07	102849	12056	17,50	158	241	53,63
102771	11768	6,50	97	148	5,14	102850	12059	17,75	158	241	69,69
102772	11771	6,60	97	148	6,07	102851	12062	18,00	158	241	37,83
102773	11774	6,70	97	148	6,07	102852	12065	18,25	158	241	82,09
102774	11777	6,75	102	156	6,29	102853	12068	18,50	162	247	58,59
102775	11780	6,80	102	156	6,29	102854	12074	19,00	162	247	47,41
102776	11783	6,90	102	156	6,44	102855	12080	19,50	166	254	91,21
102777	11786	7,00	102	156	5,99	102856	12083	19,75	166	254	103,00
102778	11789	7,10	102	156	6,44	102857	12086	20,00	166	254	53,21



1040 Broca mango cilíndrico extra-larga HSS



HSS	DIN 1869 N				Blue Finish	Rectificado Ground Taillé Meulé	Tol. D h8
-----	------------	--	--	--	-------------	------------------------------------	-----------

Ref. HSS	Código HSS	l mm	L mm	Ø h8 mm	€/ u.	Ref. HSS	Código HSS	l mm	L mm	Ø h8 mm	€/ u.
103400	12158	85	125	2,00	11,09	103424	12230	235	350	6,50	35,92
103401	12161	95	140	2,50	11,59	103425	12233	155	225	7,00	23,65
103402	12164	100	150	3,00	12,01	103426	12236	200	290	7,00	32,94
103403	12167	136	190	3,00	13,87	103427	12239	250	370	7,00	44,53
103404	12170	115	165	3,50	13,54	103428	12242	155	225	7,50	26,64
103405	12173	145	210	3,50	15,61	103429	12245	200	290	7,50	35,48
103406	12176	180	265	3,50	22,34	103430	12248	250	370	7,50	51,70
103407	12179	120	175	4,00	13,54	103431	12251	165	240	8,00	29,43
103408	12182	150	220	4,00	15,95	103432	12254	210	305	8,00	40,77
103409	12185	190	280	4,00	22,76	103433	12257	265	390	8,00	53,12
103410	12188	125	185	4,50	15,02	103434	12260	165	240	8,50	40,06
103411	12191	160	235	4,50	18,74	103435	12263	210	305	8,50	54,58
103412	12194	200	295	4,50	26,82	103436	12266	265	390	8,50	75,07
103413	12197	135	195	5,00	15,85	103437	12269	175	250	9,00	38,18
103414	12200	170	245	5,00	20,16	103438	12272	220	320	9,00	50,43
103415	12203	210	315	5,00	24,77	103439	12275	280	410	9,00	74,05
103416	12206	140	205	5,50	18,77	103440	12278	175	250	9,50	44,99
103417	12209	180	260	5,50	26,82	103441	12281	220	320	9,50	61,83
103418	12212	225	330	5,50	30,95	103442	12284	280	410	9,50	83,30
103419	12215	140	205	6,00	18,77	103443	12287	185	265	10,00	44,39
103420	12218	180	260	6,00	26,82	103444	12290	235	340	10,00	58,08
103421	12221	225	330	6,00	30,95	103445	12293	295	430	10,00	80,69
103422	12224	150	215	6,50	22,34	103446	28866	195	280	11,00	56,21
103423	12227	190	275	6,50	28,83	103447	28867	205	295	12,00	74,21

03

1050 Broca mango cilíndrico extra-corta HSS



HSS	DIN 1897 N			DIN 1412 C ≥ 2 mm	Blue Finish	Rectificado Ground Taillé Meulé	Tol. D h8
-----	------------	--	--	----------------------	-------------	------------------------------------	-----------

Ref. HSS	Código HSS	l mm	L mm	Ø h8 mm	€/ u.	Ref. HSS	Código HSS	l mm	L mm	Ø h8 mm	€/ u.
103700	20606	6	26	1,00	1,22	103736	12410	24	58	4,50	1,27
103701	20615	8	30	1,25	1,06	103737	20636	24	58	4,60	1,64
103702	12302	9	32	1,50	1,06	103738	20639	24	58	4,70	1,64
103703	12305	10	34	1,60	1,23	103739	12413	24	58	4,75	1,41
103704	12311	11	36	1,75	1,22	103740	12416	26	62	4,80	1,64
103705	12314	12	38	1,80	1,23	103741	12419	26	62	4,90	1,64
103706	12320	12	38	2,00	1,05	103742	12422	26	62	5,00	1,41
103707	12323	13	40	2,10	1,10	103743	12425	26	62	5,10	1,79
103708	12326	13	40	2,20	1,10	103744	12428	26	62	5,20	1,79
103709	12329	13	40	2,25	0,95	103745	12431	26	62	5,25	1,57
103710	12332	13	40	2,30	1,10	103746	12434	26	62	5,30	1,80
103711	12335	14	43	2,40	1,10	103747	12437	28	66	5,40	1,80
103712	12338	14	43	2,50	0,84	103748	12440	28	66	5,50	1,57
103713	12341	14	43	2,60	1,03	103749	12443	28	66	5,60	2,07
103714	12344	16	46	2,70	1,03	103750	12446	28	66	5,70	2,07
103715	12347	16	46	2,75	0,91	103751	12449	28	66	5,75	1,78
103716	12350	16	46	2,80	1,04	103752	12452	28	66	5,80	2,07
103717	12353	16	46	2,90	1,04	103753	12455	28	66	5,90	2,07
103718	12356	16	46	3,00	0,91	103754	12458	28	66	6,00	1,78
103719	12359	18	49	3,10	0,97	103755	20651	31	70	6,10	2,42
103720	12362	18	49	3,20	0,97	103756	20654	31	70	6,20	2,42
103721	12365	18	49	3,25	0,97	103757	12461	31	70	6,25	2,12
103722	12368	18	49	3,30	0,97	103758	20657	31	70	6,30	2,42
103723	12371	20	52	3,40	1,10	103759	20663	31	70	6,40	2,42
103724	12374	20	52	3,50	0,97	103760	12464	31	70	6,50	2,12
103725	12377	20	52	3,60	1,23	103761	20666	31	70	6,60	2,84
103726	12380	20	52	3,70	1,23	103762	20669	31	70	6,70	2,84
103727	12383	20	52	3,75	1,07	103763	12467	34	74	6,75	2,44
103728	12386	22	55	3,80	1,23	103764	20672	34	74	6,80	2,44
103729	12389	22	55	3,90	1,23	103765	12470	34	74	7,00	2,44
103730	12392	22	55	4,00	1,07	103804	20681	34	74	7,20	3,16
103731	12395	22	55	4,10	1,27	103766	27317	34	74	7,25	2,78
103732	12398	22	55	4,20	1,27	103767	12473	34	74	7,50	2,78
103733	12401	22	55	4,25	1,27	103768	12476	37	79	7,75	3,06
103734	12404	24	58	4,30	1,44	103769	20696	37	79	7,80	3,51
103735	12407	24	58	4,40	1,44						





1050 Broca mango cilíndrico extra-corta HSS

Ref. HSS	Código HSS	l mm	L mm	Ø h8 mm	€/ u.	Ref. HSS	Código HSS	l mm	L mm	Ø h8 mm	€/ u.
103770	12479	37	79	8,00	3,06	103787	12533	51	102	12,50	8,25
103771	12482	37	79	8,25	3,64	103788	20813	51	102	12,70	8,68
103772	12485	37	79	8,50	3,64	103789	12539	51	102	13,00	9,01
103773	12488	40	84	8,75	3,99	103790	12545	54	107	13,50	11,45
103774	12491	40	84	9,00	3,99	103791	12551	54	107	14,00	12,37
103775	12494	40	84	9,25	4,45	103792	12554	56	111	14,50	14,13
103776	12497	40	84	9,50	4,45	103793	12557	56	111	15,00	16,15
103777	27334	43	89	9,75	4,96	103794	12560	58	115	15,50	19,46
103778	12500	43	89	10,00	4,96	103795	12563	58	115	16,00	19,46
103779	20756	43	89	10,20	5,62	103796	12566	60	119	16,50	22,90
103780	12503	43	89	10,25	6,23	103797	12569	60	119	17,00	22,90
103781	12506	43	89	10,50	5,62	103798	12572	62	123	17,50	25,51
103782	12512	47	95	11,00	6,23	103799	12575	62	123	18,00	25,51
103783	12515	47	95	11,25	6,93	103800	12578	64	127	18,50	28,40
103784	12518	47	95	11,50	6,93	103801	12581	64	127	19,00	28,40
103785	12527	51	102	12,00	7,33	103802	12584	66	131	19,50	34,06
103786	12530	51	102	12,25	8,25	103803	12587	66	131	20,00	34,06

1056 Broca mango cilíndrico materiales duros extra-corta HSSE

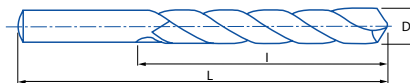

HSSE 5%Co	DIN 1897 N	135°		DIN 1412 C ≥ 2 mm		Ambar Gold Finish Finition Or	Rectificado Ground Taillé Meulé	A.R.I.* * Alto Rendimiento Intensivo I.H.P.* * Intensive High Performance H.P.I.* * Haute Performance Intensif	Tol. D h8
--------------	---------------	------	--	-------------------------	--	-------------------------------------	---------------------------------------	--	--------------

Ref. HSSE	Código HSSE	Ø h8 mm	l mm	L mm	€/ u.	Ref. HSSE	Código HSSE	Ø h8 mm	l mm	L mm	€/ u.
103900	27835	1,00	6	26	2,04	103940	27901	4,80	26	62	2,71
103901	11532	1,25	8	30	2,42	103941	27903	4,90	26	62	2,71
103902	27986	1,50	9	32	1,96	103942	27905	5,00	26	62	2,51
103903	27838	1,60	10	34	2,50	103943	27908	5,10	26	62	3,06
103904	11536	1,75	11	36	2,42	103944	27910	5,20	26	62	3,06
103905	11537	1,80	11	36	2,50	103945	27912	5,25	26	62	2,78
103906	27841	2,00	12	38	1,97	103946	11554	5,30	26	62	3,06
103907	11539	2,10	12	38	2,34	103947	11555	5,40	28	66	3,06
103908	11540	2,20	13	40	2,34	103948	27916	5,50	28	66	2,78
103909	11541	2,25	13	40	2,29	103949	11556	5,60	28	66	3,22
103910	11543	2,30	13	40	2,34	103950	11557	5,70	28	66	3,22
103911	27844	2,40	14	43	2,34	103951	27919	5,75	28	66	3,36
103912	27846	2,50	14	43	1,60	103952	11558	5,80	28	66	3,22
103913	28016	2,60	14	43	1,86	103953	11559	5,90	28	66	3,22
103914	27850	2,70	16	46	1,86	103954	27926	6,00	28	66	3,17
103915	11544	2,75	16	46	1,95	103955	11561	6,10	31	70	4,08
103916	11545	2,80	16	46	1,86	103956	11562	6,20	31	70	4,08
103917	11547	2,90	16	46	1,86	103957	11563	6,25	31	70	4,24
103918	27853	3,00	16	46	1,60	103958	27929	6,30	31	70	4,08
103919	27856	3,10	18	49	1,71	103959	28094	6,40	31	70	4,08
103920	27864	3,20	18	49	1,71	103960	27931	6,50	31	70	3,80
103921	27866	3,25	18	49	1,71	103961	11565	6,60	31	70	5,12
103922	27870	3,30	18	49	1,71	103962	11567	6,70	31	70	5,12
103923	11548	3,40	20	52	2,08	103963	11568	6,75	34	74	5,27
103924	27872	3,50	20	52	1,71	103964	27934	6,80	34	74	5,27
103925	11549	3,60	20	52	2,08	103965	27936	7,00	34	74	4,36
103926	11550	3,70	20	52	2,08	103966	11572	7,25	34	74	5,63
103927	27875	3,75	20	52	2,15	103967	27939	7,50	34	74	5,27
103928	27878	3,80	22	55	2,08	103968	11577	7,75	37	79	6,09
103929	11551	3,90	22	55	2,08	103969	11586	7,80	37	79	6,47
103930	27880	4,00	22	55	1,90	103970	27941	8,00	37	79	5,46
103931	27884	4,10	22	55	2,26	103971	11595	8,25	37	79	7,15
103932	27888	4,20	22	55	2,26	103972	27944	8,50	37	79	6,43
103933	27891	4,25	22	55	2,26	103973	11616	8,75	40	84	7,79
103934	11552	4,30	24	58	2,60	103974	27947	9,00	40	84	7,09
103935	11553	4,40	24	58	2,60	103975	28122	9,25	40	84	8,78
103936	27894	4,50	24	58	2,26	103976	27950	9,50	40	84	7,97
103937	28058	4,60	24	58	2,71	103977	11712	9,75	43	89	9,75
103938	28061	4,70	24	58	2,71	103978	27953	10,00	43	89	8,89
103939	27898	4,75	24	58	2,51	103979	11730	10,20	43	89	9,90



1056 Broca mango cilíndrico materiales duros extra-corta HSSE

Ref. HSSE	Código HSSE	Ø h8 mm	l mm	L mm	€/ u.	Ref. HSSE	Código HSSE	Ø h8 mm	l mm	L mm	€/ u.
103980	11736	10,25	43	89	12,20	103992	11835	14,50	56	111	30,51
103981	28136	10,50	43	89	9,90	103993	11838	15,00	56	111	30,95
103982	27956	11,00	47	95	11,07	103994	11853	15,50	58	115	35,81
103983	11793	11,25	47	95	16,15	103995	11865	16,00	58	115	37,14
103984	27959	11,50	47	95	13,08	103996	11871	16,50	60	119	42,50
103985	27962	12,00	51	102	14,00	103997	11874	17,00	60	119	42,50
103986	11808	12,25	51	102	19,38	103998	11880	17,50	62	123	47,05
103987	27965	12,50	51	102	17,06	103999	11883	18,00	62	123	51,28
103988	27968	12,70	51	102	19,48	104000	11889	18,50	64	127	56,61
103989	27971	13,00	51	102	17,47	104001	11898	19,00	64	127	56,61
103990	27974	13,50	54	107	20,42	104002	11901	19,50	66	131	62,77
103991	27978	14,00	54	107	21,99	104003	11907	20,00	66	131	67,22

1054 Broca mango cilíndrico extra-corta Hardox X-AICr



03



Cobalt "S"	X-AICr	DIN 1897 N	135°	DIN 1412 C ≥ 2 mm	Rectificado Ground Taillé Meulé	Tol. D h8
------------	--------	------------	------	-------------------	------------------------------------	-----------

Ref. X-AICr	Código X-AICr	l mm	L mm	Ø h8 mm	€/ u.	Ref. X-AICr	Código X-AICr	l mm	L mm	Ø h8 mm	€/ u.
146500	32693	12	38	2,00	6,68	146516	32709	37	79	8,50	22,60
146501	32694	14	43	2,50	5,79	146517	32710	40	84	9,00	23,50
146502	32695	16	46	3,00	5,79	146518	32711	40	84	9,50	24,82
146503	32696	18	49	3,30	8,17	146519	32712	43	89	10,00	26,19
146504	32697	20	52	3,50	8,17	146520	32713	43	89	10,20	28,40
146505	32698	22	55	4,00	8,47	146521	32714	43	89	10,50	28,40
146506	32699	22	55	4,20	8,97	146522	32715	47	95	11,00	30,52
146507	32700	24	58	4,50	8,97	146523	32716	47	95	11,50	32,37
146508	32701	26	62	5,00	9,49	146524	32717	51	102	12,00	32,16
146509	32702	28	66	5,50	10,59	146525	32718	51	102	12,50	42,84
146510	32703	28	66	6,00	11,20	146526	32719	51	102	13,00	44,30
146511	32704	31	70	6,50	13,98	146527	32720	54	107	14,00	53,71
146512	32705	34	74	6,80	16,25	146528	32721	56	111	15,00	67,17
146513	32706	34	74	7,00	14,82	146529	32722	58	115	16,00	76,37
146514	32707	34	74	7,50	16,72	146530	32723	62	123	18,00	105,39
146515	32708	37	79	8,00	16,49						

Juegos de brocas DIN 338



Juego de brocas de alta calidad en acero rápido.

Ref.	Código	Contenido	Nº Piezas	Material	€/ u.
8005597	2456	Ø 1-13x0,50 mm	25	HSS	43,93
2400676	2466	Ø 1-10x0,50 mm	19		89,83



1110 Broca mango cónico HSS

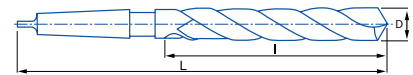

HSS	DIN 345 N	118°			Blue Finish	Rectificado Ground Taillé Meulé	Tol. D h8
-----	-----------	------	--	--	-------------	------------------------------------	-----------

Ref. HSS	Código HSS	Ø h8 mm	CM	l mm	L mm	€/ u.	Ref. HSS	Código HSS	Ø h8 mm	CM	l mm	L mm	€/ u.
105100	14426	5,00	1	52	133	14,76	105163	14615	20,75	2	145	243	50,87
105101	14429	5,25	1	52	133	16,97	105164	14618	21,00	2	145	243	44,23
105102	14432	5,50	1	57	138	14,76	105165	14621	21,25	2	150	248	56,12
105103	14435	5,75	1	57	138	16,97	105166	14624	21,50	2	150	248	48,77
105104	14438	6,00	1	57	138	14,76	105167	14627	21,75	2	150	248	56,12
105105	14441	6,25	1	63	144	19,33	105168	14630	22,00	2	150	248	48,77
105106	14444	6,50	1	63	144	15,70	105169	14633	22,25	2	150	248	61,40
105107	14447	6,75	1	69	150	18,05	105170	14636	22,50	2	155	253	53,39
105108	14450	7,00	1	69	150	15,70	105171	14639	22,75	2	155	253	61,40
105109	14453	7,25	1	69	150	20,77	105172	14642	23,00	2	155	253	53,39
105110	14456	7,50	1	69	150	16,89	105173	14645	23,25	3	155	276	67,74
105111	14459	7,75	1	75	156	20,77	105174	14648	23,50	3	155	276	58,90
105112	14462	8,00	1	75	156	16,83	105175	14651	23,75	3	160	281	67,74
105113	14465	8,25	1	75	156	24,37	105176	14654	24,00	3	160	281	58,90
105114	14468	8,50	1	75	156	18,31	105177	14657	24,25	3	160	281	73,89
105115	14471	8,75	1	81	162	21,90	105178	14660	24,50	3	160	281	64,23
105116	14474	9,00	1	81	162	18,31	105179	14663	24,75	3	160	281	73,89
105117	14477	9,25	1	81	162	24,22	105180	14666	25,00	3	160	281	64,23
105118	14480	9,50	1	81	162	18,08	105181	14669	25,25	3	165	286	80,38
105119	14483	9,75	1	87	168	24,22	105182	14672	25,50	3	165	286	69,88
105120	14486	10,00	1	87	168	17,76	105183	14675	25,75	3	165	286	80,38
105121	14489	10,25	1	87	168	22,67	105184	14678	26,00	3	165	286	69,88
105122	14492	10,50	1	87	168	19,69	105185	14681	26,25	3	165	286	87,03
105123	14495	10,75	1	94	175	22,67	105186	14684	26,50	3	165	286	75,68
105124	14498	11,00	1	94	175	19,69	105187	14687	26,75	3	170	291	87,03
105125	14501	11,25	1	94	175	23,84	105188	14690	27,00	3	170	291	75,68
105126	14504	11,50	1	94	175	20,74	105189	14693	27,25	3	170	291	93,14
105127	14507	11,75	1	94	175	23,84	105190	14696	27,50	3	170	291	81,03
105128	14510	12,00	1	101	182	20,74	105191	14699	27,75	3	170	291	93,14
105129	14513	12,25	1	101	182	26,54	105192	14702	28,00	3	170	291	81,03
105130	14516	12,50	1	101	182	22,21	105193	14705	28,25	3	175	296	99,93
105131	14519	12,75	1	101	182	26,54	105194	14708	28,50	3	175	296	86,88
105132	14522	13,00	1	101	182	23,10	105195	14711	28,75	3	175	296	99,93
105133	14525	13,25	1	108	189	29,20	105196	14714	29,00	3	175	296	86,88
105134	14528	13,50	1	108	189	24,39	105197	14717	29,25	3	175	296	109,87
105135	14531	13,75	1	108	189	29,20	105198	14720	29,50	3	175	296	95,53
105136	14534	14,00	1	108	189	24,39	105199	14723	29,75	3	175	296	109,87
105137	14537	14,25	2	114	212	31,62	105200	14726	30,00	3	175	296	95,53
105138	14540	14,50	2	114	212	27,52	105201	14729	30,25	3	180	301	122,26
105139	14543	14,75	2	114	212	31,62	105202	14732	30,50	3	180	301	106,31
105140	14546	15,00	2	114	212	27,52	105203	14735	30,75	3	180	301	122,26
105141	14549	15,25	2	120	218	32,74	105204	14738	31,00	3	180	301	106,31
105142	14552	15,50	2	120	218	28,46	105205	14741	31,25	3	180	301	129,47
105143	14555	15,75	2	120	218	32,74	105206	14744	31,50	3	180	301	112,57
105144	14558	16,00	2	120	218	28,46	105207	14747	31,75	3	185	306	129,47
105145	14561	16,25	2	125	223	37,04	105208	14750	32,00	4	185	334	112,57
105146	14564	16,50	2	125	223	32,19	105209	14753	32,50	4	185	334	128,60
105147	14567	16,75	2	125	223	37,04	105210	14756	33,00	4	185	334	128,60
105148	14570	17,00	2	125	223	32,19	105211	14759	33,50	4	185	334	139,82
105149	14573	17,25	2	130	228	40,97	105212	14762	34,00	4	190	339	139,82
105150	14576	17,50	2	130	228	35,62	105213	14765	34,50	4	190	339	152,79
105151	14579	17,75	2	130	228	40,97	105214	14768	35,00	4	190	339	152,79
105152	14582	18,00	2	130	228	34,27	105215	14771	35,50	4	190	339	163,94
105153	14585	18,25	2	135	233	45,08	105216	14774	36,00	4	195	344	163,94
105154	14588	18,50	2	135	233	39,21	105217	14777	36,50	4	195	344	172,81
105155	14591	18,75	2	135	233	45,08	105218	14780	37,00	4	195	344	172,81
105156	14594	19,00	2	135	233	39,21	105219	14783	37,50	4	195	344	181,77
105157	14597	19,25	2	140	238	49,07	105220	14786	38,00	4	200	349	181,77
105158	14600	19,50	2	140	238	42,67	105221	14789	38,50	4	200	349	193,85
105159	14603	19,75	2	140	238	49,07	105222	14792	39,00	4	200	349	193,85
105160	14606	20,00	2	140	238	42,67	105223	14795	39,50	4	200	349	204,69
105161	14609	20,25	2	145	243	50,87	105224	14798	40,00	4	200	349	204,69
105162	14612	20,50	2	145	243	44,23							



1310 Broca de centrar doble

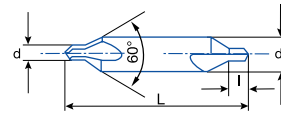

HSS	HSS + TIN	DIN 333 A	118°	Blanca Bright Finish Finition Blanc	Rectificado Ground Taillé Meulé
-----	-----------	-----------	------	---	---------------------------------------

Ref. HSS	Código HSS	€/ u. HSS	Ref. TIN	Código TIN	€/ u. TIN	Ø d mm	Ø d1 mm	l mm	L mm
107200	40001	4,96	107300	74157	9,57	1,00	3,15	1,3	31,5
107201	40004	4,96	107301	74160	9,57	1,25	3,15	1,6	31,5
107202	40007	5,27	107302	74163	10,27	1,25	4,00	1,6	35,5
107203	40010	4,96	107303	74885	10,01	1,60	4,00	2	35,5
107204	40013	5,27	107304	74882	10,83	1,60	5,00	2	40,0
107205	40016	5,39	107305	74166	10,96	2,00	5,00	2,5	40
107206	40019	5,78	107306	74883	11,77	2,00	6,30	2,5	45,0
107207	40022	5,95	107307	60380	11,93	2,50	6,30	3,1	45
107208	40025	6,56	107308	74884	12,49	2,50	8,00	3,1	50,0
107209	40028	6,56	107309	74169	12,49	3,15	8,00	3,9	50

Ref. HSS	Código HSS	€/ u. HSS	Ref. TIN	Código TIN	€/ u. TIN	Ø d mm	Ø d1 mm	l mm	L mm
107210	40031	7,71	107310	73574	15,73	3,15	10,00	3,9	56,0
107211	40034	9,48	107311	60383	17,37	4,00	10,00	5	56,0
107212	40037	10,55	107312	74876	19,50	4,00	12,50	5	63,0
107213	40040	15,87				5,00	12,50	6,3	63
107214	40043	25,28	107313	74172	35,40	5,00	16,00	6,3	71,0
107215	40046	22,75				6,30	16,00	8	71
107216	40049	38,59				6,30	20,00	8	80,0
107217	40055	65,73				10,00	25,00	12,8	100,0
107218	74881	156,89				12,50	31,50	16,5	125,0

1301 Broca de centrar CNC

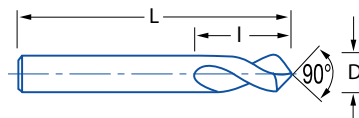

HSSE 5%Co	IZAR Std.	90°	Blanca Bright Finish Finition Blanc	Rectificado Ground Taillé Meulé
-----------	-----------	-----	---	---------------------------------------

Ref. HSSE	Código HSSE	l mm	L mm	Ø h8 mm	€/ u.
107400	69189	10	50	3,00	17,66
107401	69190	12	52	4,00	17,66
107402	69192	15	60	5,00	19,89
107403	69193	20	66	6,00	19,89
107404	69195	25	79	8,00	22,47

Ref. HSSE	Código HSSE	l mm	L mm	Ø h8 mm	€/ u.
107405	69196	25	89	10,00	22,47
107406	69198	30	102	12,00	31,06
107407	69199	35	115	16,00	42,82
107408	69201	40	131	20,00	84,28
107409	69202	45	138	25,00	109,19

1886 Broca pared profesional



Ref.	Código	Ø D mm	L mm	€/ u.
21057000	30232	3	60	2,02
21057001	18525	4	75	2,02
21057002	18526	5	85	2,05
21057003	30176	5	150	2,84
21057004	23983	5	085	2,13
21057005	18528	6	100	2,21
21057006	30200	6	150	3,48

Ref.	Código	Ø D mm	L mm	€/ u.
21057007	23984	6	100	2,41
21057008	18529	7	100	2,65
21057009	18531	8	120	2,96
21057010	30208	8	200	5,39
21057011	18532	9	120	3,71
21057012	18534	10	120	3,71
21057013	30214	10	200	6,63

Ref.	Código	Ø D mm	L mm	€/ u.
21057014	17858	11	150	4,77
21057015	18535	12	150	5,57
21057016	30222	12	200	6,77
21057017	30234	13	150	6,96
21057018	18537	14	150	8,21



03



1846 Broca de pared profesional larga

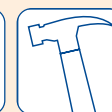
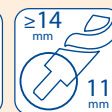
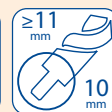
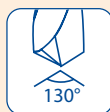

Serie Extra Larga
Extra Long Series
Série Extra-Longue

Hormigón Bloque
Concrete Block
Parpaing

Hormigón/ Concrete/ Béton

Ref.	Código	Ø mm	l mm	Longitud mm	€/ u.
109500	30202	6	300	400	6,28
109501	30212	8	300	400	6,28
109502	30216	10	300	400	6,57
109503	30218	10	450	600	10,75
109504	30227	12	300	400	7,07
8000207	30229	12	450	600	11,72
109505	30233	14	300	400	8,98
8000208	30236	14	450	600	14,20
109506	30237	16	300	400	15,71

Ref.	Código	Ø mm	l mm	Longitud mm	€/ u.
8000209	30238	16	450	600	18,13
109507	30207	18	300	400	19,65
8000210	16477	18	450	600	24,38
109508	30225	20	300	400	21,77
8000211	16478	20	450	600	28,28
109509	16474	22	300	400	25,05
109510	16475	24	300	400	25,94
109511	16476	25	300	400	29,62

1891 Broca SDS PLUS zentro4 hormigón reforzado



Zentro 4+

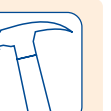
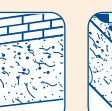
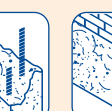
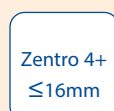

Hormigón Reforzado
Reinforced Concrete
Béton Armé

Hormigón
Concrete
Béton

Hormigón Bloque
Concrete Block
Parpaing

Piedra Natural
Natural Stone
Pierre Naturelle

Punta centradora MD. Hombros reforzados. Diseño nucleo reforzado exclusivo.

Ref.	Código	Ø mm	L mm	€/ u.
8000195	32043	5	115	5,09
8000196	32044	5	165	5,69
8000197	55961	5	215	8,34
8000198	66376	5	265	10,40
8000199	69437	5	315	13,35
108716	32045	6	115	4,98
108717	32046	6	165	5,46
108718	32047	6	215	7,35
108719	32048	6	265	8,82
108720	32049	6	315	12,92
108721	32050	6,5	165	7,08
108722	32074	6,5	215	9,59
108723	32052	7	115	6,72
108724	32053	7	165	7,12
8000200	68615	7	215	9,82
108725	32054	8	115	6,54
108726	32055	8	165	6,54
108727	32056	8	215	8,20
108728	32057	8	265	9,00
108729	36686	8	315	11,49
108730	36687	8	465	19,01
108731	32058	10	115	7,43
108732	32059	10	165	7,94
108733	32060	10	215	9,48
108734	32061	10	265	12,20
108735	32062	10	315	15,52
108736	32063	10	465	21,28
108737	36688	10	600	27,13
108739	32064	12	160	9,86
108740	32065	12	210	11,77
108741	32066	12	260	14,26
108742	32067	12	310	18,53
108743	32068	12	450	23,16

Ref.	Código	Ø mm	L mm	€/ u.
108744	36690	12	600	27,86
8000201	36697	12	1.000	63,97
108746	32069	14	160	11,40
108747	32070	14	210	15,30
108748	36691	14	310	21,93
108749	36692	14	450	27,48
108750	36693	14	600	38,36
8000202	36694	14	1.000	85,82
8000203	60059	15	160	17,62
8000204	60061	15	260	22,87
8000205	60062	15	450	29,69
108752	36695	16	160	21,80
108753	36696	16	210	24,52
108754	36863	16	260	28,36
108755	36699	16	310	29,63
108756	37455	16	450	37,13
108757	22113	16	600	50,10
8000206	36698	16	1.000	101,73
108701	16919	18	250	37,98
108702	16920	18	450	44,63
108703	16921	20	250	42,89
108704	16922	20	450	51,15
108705	39687	22	250	51,75
108706	16925	22	450	61,60
108707	39688	24	250	58,09
108708	16927	24	450	65,20
108709	39689	25	250	59,67
108710	16928	25	450	66,11
108711	11523	28	250	68,95
108712	11524	28	450	75,99
108713	39690	30	250	88,18
108714	11525	30	450	96,23
108715	11526	32	450	107,44



1890 Broca SDS PLUS hormigón



Ref.	Código	Ø D mm	L mm	€ / u.
21057019	30245	4	110	4,20
21057020	43405	4	160	5,11
21057021	30246	5	110	3,04
21057022	30247	5	160	3,96
21057023	42770	5	210	6,32
21057024	70631	5	260	7,67
21057025	69445	5	310	8,47
21057026	70633	5	360	13,32
21057027	70634	5	460	23,06
21057028	23976	5	110	3,53
21057029	23977	5	160	4,44
21057030	70636	5	210	7,28
21057031	69446	5	260	9,44
21057032	70637	5	310	11,09
21057033	30248	6	110	3,12
21057034	18538	6	160	3,60
21057035	30249	6	210	5,96
21057036	30251	6	260	7,66
21057037	70639	6	310	11,97
21057038	69448	6	460	16,02
21057039	23978	6	110	3,58
21057040	23979	6	160	4,20
21057041	59957	6	260	9,09
21057042	30252	7	110	4,52
21057043	30253	7	160	4,84
21057044	68614	7	210	6,14
21057045	19592	7	250	8,71
21057046	30254	8	110	3,77
21057047	18540	8	160	3,95

Ref.	Código	Ø D mm	L mm	€ / u.
21057048	30255	8	210	5,38
21057049	30256	8	260	7,64
21057050	30257	8	460	16,02
21057051	11518	9	160	6,01
21057052	11519	9	210	6,55
21057053	30261	10	110	4,51
21057054	30262	10	160	5,05
21057055	18541	10	210	6,07
21057056	30263	10	260	8,93
21057057	30264	10	310	10,36
21057058	30266	10	450	16,76
21057059	30267	10	600	23,47
21057060	11520	11	160	6,63
21057061	25600	11	210	6,71
21057062	11521	11	260	10,27
21057063	30270	12	160	5,36
21057064	30271	12	210	6,79
21057065	30273	12	260	9,66
21057066	42771	12	310	13,02
21057067	30414	12	450	15,34
21057068	30275	12	600	24,30
21057069	30276	13	160	6,40
21057070	74789	13	210	10,01
21057071	30278	13	310	12,58
21057072	55407	13	450	20,73
21057073	30280	14	160	7,38
21057074	30281	14	210	10,77
21057075	42772	14	260	12,92
21057076	30283	14	310	13,63

Ref.	Código	Ø D mm	L mm	€ / u.
21057077	30284	14	450	17,92
21057078	30285	14	600	26,61
21057079	30286	15	160	10,25
21057080	69917	15	210	12,50
21057081	42773	15	260	13,37
21057082	70642	15	450	22,38
21057083	30291	16	160	10,25
21057084	30292	16	210	12,50
21057085	42774	16	260	13,48
21057086	30294	16	310	14,42
21057087	30295	16	450	21,31
21057088	30296	16	600	28,63
21057089	30300	18	200	16,05
21057090	30413	18	300	21,34
21057091	30303	18	450	24,33
21057092	30306	20	200	22,31
21057093	30309	20	300	25,04
21057094	30311	20	450	31,59
21057095	30312	20	600	46,87
21057096	30314	22	250	28,66
21057097	30317	22	450	39,91
21057098	23980	22	600	47,78
21057099	30319	24	250	33,44
21057100	30322	24	450	43,40
21057101	30324	25	250	36,21
21057102	30327	25	450	46,41
21057103	23987	25	1.000	83,31
21057104	11522	26	250	45,36
21057105	30330	26	450	51,22

03

1892 Broca SDS MAX hormigón



Ref.	Código	Ø D mm	L mm	€ / u.
21057106	30332	12	340	43,17
21057107	30333	12	540	50,63
21057108	30334	12	690	76,91
21057109	30335	14	340	46,70
21057110	30336	14	540	53,30
21057111	30337	15	340	50,46
21057112	30338	15	540	56,68
21057113	30339	16	340	55,25
21057114	30340	16	540	63,24
21057115	60065	16	940	106,19
21057116	60066	16	1.320	203,36
21057117	30341	18	340	56,68
21057118	30342	18	540	69,29
21057119	60068	18	940	106,30
21057120	60070	18	1.320	209,67
21057121	30343	20	320	57,57
21057122	30344	20	520	74,60
21057123	30345	20	920	106,41
21057124	60072	20	1.320	251,20
21057125	30346	22	320	65,91

Ref.	Código	Ø D mm	L mm	€ / u.
21057126	30347	22	520	78,33
21057127	30348	22	920	115,48
21057128	60075	22	1.320	268,41
21057129	30349	24	320	68,22
21057130	30350	24	520	83,85
21057131	30351	25	320	70,18
21057132	30352	25	520	85,28
21057133	30353	25	920	126,66
21057134	60077	25	1.320	273,51
21057135	30354	26	520	86,88
21057136	30355	28	370	84,57
21057137	30356	28	570	94,34
21057138	30357	28	670	116,54
21057139	60079	28	920	140,51
21057140	30358	30	370	92,20
21057141	30359	30	570	98,24
21057142	30360	32	370	95,93
21057143	30361	32	570	119,55
21057144	30362	32	920	164,68
21057145	60085	32	1.320	291,55

Ref.	Código	Ø D mm	L mm	€ / u.
21057146	30363	35	370	106,58
21057147	30364	35	570	127,74
21057148	30365	35	670	150,83
21057149	60088	37	370	112,21
21057150	60089	37	570	129,62
21057151	60090	37	920	191,21
21057152	30366	38	370	123,83
21057153	30367	38	570	131,47
21057154	79736	38	720	191,27
21057155	79737	38	920	202,30
21057156	30368	40	370	135,01
21057157	30369	40	570	154,56
21057158	30370	40	920	211,41
21057159	60093	40	1.320	335,88
21057160	30371	45	570	222,05
21057161	23981	45	920	305,68
21057162	52952	50	570	246,40
21057163	52954	52	570	299,62



Broca EXPERT SDS plus-7x (cabeza maciza)

BOSCH 

Dura hasta 3 veces más que la broca Bosch SDS plus-3./ Punta de broca extremadamente duradera con Bosch Carbide Technology./ Compatible con todos los martillos perforadores SDS plus../ Ideal para perforar orificios en hormigón armado, por ejemplo, para anclar instalaciones interiores como acondicionadores de aire, tuberías de calefacción, cableado eléctrico y luces../ La mejor para electricistas: duradera y potente. Piedra blanda; Piedra dura; Hormigón; Hormigón armado; Bloque de construcción de hormigón



Ref.	Código	Ø D mm	Longitud de trabajo (L1) mm	Longitud total (L2) mm	€/ u.	Ref.	Código	Ø D mm	Longitud de trabajo (L1) mm	Longitud total (L2) mm	€/ u.
2400677	2608900059	5	50	115	8,54	2400682	2608900089	8	150	215	11,29
2400678	2608900071	6	50	115	7,75	2400683	2608900097	10	100	165	11,46
2400679	2608900072	6	100	165	8,16	2400684	2608900098	10	150	215	13,29
2400680	2608900087	8	50	115	9,25	2400685	2608900108	12	100	165	13,50
2400681	2608900088	8	100	165	9,73	2400686	2608900109	12	150	215	15,66

Broca EXPERT SDS plus-7x (cabeza maciza)

BOSCH 

Dura hasta 3 veces más que la broca Bosch SDS plus-3./ Punta de broca extremadamente duradera con Bosch Carbide Technology./ Compatible con todos los martillos perforadores SDS plus../ Ideal para perforar orificios en hormigón armado, por ejemplo, para anclar instalaciones interiores como acondicionadores de aire, tuberías de calefacción, cableado eléctrico y luces../ La mejor para electricistas: duradera y potente. Piedra blanda; Piedra dura; Hormigón; Hormigón armado; Bloque de construcción de hormigón



Ref.	Código	Contenido mm	Longitud de trabajo mm	Longitud total mm	€/ u.
2400687	2608900197	5,0; 6,0; 6,0; 8,0; 10,0	50; 50; 100; 100; 100	115; 115; 165; 165; 165	44,45

Broca EXPERT HEX-9 HC porcelánico

BOSCH 

Dura hasta 10 veces más que la broca para cerámica Bosch CYL-9 Ceramic./ Punta de broca extremadamente duradera con Bosch Carbide Technology./ Hex shank for strong connection and maximum torque transmission in three-jaw chucks and 1/2" internal hex tool holders../ Ideal para taladrar agujeros en baldosas de baño, p. ej. para instalar una pared divisoria para la ducha y para taladrar tejas sin necesidad de refrigeración. Perfora cómodamente baldosas con una dureza de hasta PEI 5../ La mejor para los montadores de interiores y techadores: duradera y práctica. Azulejos duros; Baldosas blandas; Piedra dura; Tejas; Vidrio



Ref.	Código	Ø D mm	Longitud total (L2) mm	€/ u.	Ref.	Código	Ø D mm	Longitud total (L2) mm	€/ u.
2400688	2608900589	5	90	14,89	2400691	2608900593	10	90	22,84
2400689	2608900590	6	90	15,51	2400692	2608900594	12	90	25,35
2400690	2608900592	8	90	21,10					

Broca EXPERT HEX-9 HC porcelánico

BOSCH 

Dura hasta 10 veces más que la broca para cerámica Bosch CYL-9 Ceramic./ Punta de broca extremadamente duradera con Bosch Carbide Technology../ Hex shank for strong connection and maximum torque transmission in three-jaw chucks and 1/2" internal hex tool holders../ Ideal para taladrar agujeros en baldosas de baño, p. ej. para instalar una pared divisoria para la ducha y para taladrar tejas sin necesidad de refrigeración. Perfora cómodamente baldosas con una dureza de hasta PEI 5../ La mejor para los montadores de interiores y techadores: duradera y práctica. Azulejos duros; Baldosas blandas; Piedra dura; Tejas; Vidrio



Ref.	Código	Contenido mm	Longitud total mm	€/ u.
2400693	2608900595	5,0; 6,0; 8,0	90	48,93

Cinzel SDS-plus



Menos atascos y más progreso en hormigón./ El cinzel plano SDS plus es ideal para diversas aplicaciones en hormigón, con menos atascos y más progreso./ Las "Power Ribs" con autoafilado permiten alcanzar una velocidad de eliminación de material superior y previenen atascos./ Los dientes tipo víbora del borde de cincelado proporcionan un incremento en el progreso del trabajo.Hormigón; Bloque de construcción de hormigón; Ladrillos de cal y arena; Ladrillo macizo; Ladrillo



Ref.	Código	Longitud total mm	Filo del cinzel mm	€ / u.
2400694	2609390394	250	20	15,73
2400695	2608690101	250	40	29,16
2400696	2608690091	260	40	27,37

Ref.	Código	Longitud total mm	Filo del cinzel mm	€ / u.
2400697	2608690102	250	60	33,15
2400698	2608690180	140	0/20/40 (set)	46,66

Set SDS-plus



Maletín con 11 accesorios SDS-plus. Con 9 brocas SDS-plus, puntero y cinzel.

Ref.	Código	€ / u.
2400699	2608578765	56,25



Cinzel SDS-max



Sin interrupción de trabajo, menos atascos en trabajos de precisión en hormigón./ El cinzel puntiagudo SDS max RTec Speed es ideal para trabajos de precisión en hormigón sin interrupciones ni atascos./ El diseño de giro de su punta autoafilable permite mayor impacto en la eliminación de material y un trabajo más suave. Hormigón; Bloque de construcción de hormigón; Ladrillos de cal y arena; Ladrillo macizo; Ladrillo



Ref.	Código	Longitud total mm	Vástago, forma	€ / u.
2400700	2608690167	400	SDS max	27,16
2400701	2608690124	400	25	27,16
2400702	2608690097	350	50	44,32

1650 Broca para madera plana



Pala
Flat
Plate

Maderas Blandas
Soft Wood
Bois tendre

Ref.	Código	Ø mm	Longitud mm	€ / u.
110000	30384	6	152	1,62
110001	30385	8	152	1,62
110002	30386	10	152	1,71
110003	30387	12	152	1,88
110004	18457	14	152	1,96
110005	18459	16	152	2,15
110006	18460	18	152	2,42
110007	18462	20	152	2,42
110008	18463	22	152	2,81

Ref.	Código	Ø mm	Longitud mm	€ / u.
110009	18465	24	152	3,01
110010	18466	25	152	3,41
110011	18468	26	152	3,58
110012	18469	28	152	3,86
110013	18471	30	152	4,07
110014	18472	32	152	4,35
110015	30389	36	152	5,02
110016	30390	38	152	5,35
110017	17864	40	152	5,37



03

1640 Broca para madera punta de centrar



Ref.	Código	Ø mm	€ / u.
21057164	18426	3	0,70
21057165	18427	4	0,71
21057166	18429	5	0,75
21057167	18430	6	0,95

Ref.	Código	Ø mm	€ / u.
21057168	18432	7	1,03
21057169	18433	8	1,30
21057170	18435	9	1,52
21057171	18436	10	1,61

Ref.	Código	Ø mm	€ / u.
21057172	30380	11	2,02
21057173	18438	12	2,21
21057174	30381	13	2,33
21057175	18439	14	2,55

1655 Broca para madera espiral



Ref.	Código	Ø mm	Longitud mm	€ / u.
21057176	19139	6	230	10,34
21057177	60683	6	460	12,42
21057178	66809	7	230	10,63
21057179	19145	8	230	10,91
21057180	19082	8	460	13,09
21057181	66811	9	230	11,23
21057182	19148	10	230	11,52
21057183	19151	10	460	14,26
21057184	66812	11	230	11,76
21057185	19154	12	230	11,98
21057186	19163	12	460	15,45
21057187	66813	13	230	12,33

Ref.	Código	Ø mm	Longitud mm	€ / u.
21057188	19172	14	230	12,68
21057189	19181	14	460	18,91
21057190	19187	16	230	14,53
21057191	19193	16	460	22,40
21057192	19202	18	230	18,51
21057193	19205	18	460	29,98
21057194	19211	20	230	21,02
21057195	19217	20	460	33,62
21057196	19226	22	230	23,47
21057197	19229	22	460	36,98
21057198	66814	23	230	24,61
21057199	19235	24	230	25,76

Ref.	Código	Ø mm	Longitud mm	€ / u.
21057200	19238	24	460	40,54
21057201	66815	25	230	26,92
21057202	27304	26	230	28,10
21057203	27603	26	460	44,03
21057204	27604	28	230	33,17
21057205	27605	28	460	47,71
21057206	27630	30	230	47,46
21057207	27680	30	460	52,34
21057208	29040	32	230	47,46
21057209	29041	32	460	58,17

2010 Escariador HSS DIN206B mano



Ref.	Código	Ø nominal mm	€ / u.
21057210	74178	1.6	25,22
21057211	74181	1.7	25,22
21057212	74184	1.8	25,22
21057213	74187	1.9	25,22
21057214	40379	2	18,90
21057215	74190	2.1	25,22
21057216	74193	2.2	25,22
21057217	74199	2.4	25,22
21057218	40382	2.5	18,90
21057219	75397	2.6	25,22
21057220	74202	2.7	25,22
21057221	74205	2.8	25,22
21057222	40385	3	18,90
21057223	74211	3.1	25,22
21057224	74214	3.2	25,22
21057225	74217	3.3	25,22
21057226	74220	3.4	25,22
21057227	40388	3.5	19,82
21057228	74223	3.6	25,22
21057229	74226	3.7	25,22
21057230	75398	3.8	25,22
21057231	74229	3.9	25,22
21057232	40391	4	18,90
21057233	74232	4.1	26,35
21057234	74235	4.2	26,35
21057235	74238	4.3	26,35
21057236	74241	4.4	26,35
21057237	40394	4.5	19,73
21057238	74247	4.7	26,35
21057239	74250	4.8	26,35
21057240	74253	4.9	26,35
21057241	40397	5	19,73
21057242	74256	5.1	26,35
21057243	74259	5.2	26,35
21057244	74262	5.3	26,35
21057245	74265	5.4	26,35
21057246	40400	5.5	19,73
21057247	74268	5.6	26,35
21057248	74271	5.7	26,35
21057249	74274	5.8	26,35

Ref.	Código	Ø nominal mm	€ / u.
21057250	74277	5.9	26,35
21057251	40403	6	19,73
21057252	74280	6.1	26,35
21057253	75172	6.2	26,35
21057254	74283	6.3	26,35
21057255	74286	6.4	26,35
21057256	40406	6.5	19,73
21057257	75233	6.6	26,35
21057258	74289	6.7	26,35
21057259	74292	6.8	26,35
21057260	74295	6.9	26,35
21057261	40409	7	19,73
21057262	74298	7.1	27,82
21057263	74301	7.2	27,82
21057264	74947	7.3	27,82
21057265	40412	7.5	20,86
21057266	74307	7.6	27,82
21057267	74313	7.8	27,82
21057268	74316	7.9	27,82
21057269	40415	8	20,86
21057270	74319	8.1	29,21
21057271	74322	8.2	29,21
21057272	74325	8.3	29,21
21057273	40418	8.5	21,87
21057274	74331	8.6	29,21
21057275	74337	8.8	29,21
21057276	74340	8.9	29,21
21057277	40421	9	24,04
21057278	74343	9.1	30,49
21057279	74346	9.2	30,49
21057280	74349	9.3	30,49
21057281	74352	9.4	30,49
21057282	40424	9.5	25,09
21057283	74355	9.6	30,49
21057284	74358	9.7	30,49
21057285	74361	9.8	30,49
21057286	74364	9.9	30,49
21057287	40427	10	25,09
21057288	74367	10.1	38,53
21057289	74370	10.2	38,53

Ref.	Código	Ø nominal mm	€ / u.
21057290	74373	10.3	38,53
21057291	40430	10.5	28,05
21057292	74379	10.6	38,53
21057293	74382	10.7	38,53
21057294	74385	10.8	38,53
21057295	40433	11	28,05
21057296	74391	11.1	41,48
21057297	74394	11.2	41,48
21057298	74397	11.3	41,48
21057299	74400	11.4	41,48
21057300	40436	11.5	41,48
21057301	74403	11.6	41,48
21057302	74406	11.7	41,48
21057303	74409	11.8	41,48
21057304	74412	11.9	41,48
21057305	40439	12	40,70
21057306	40442	12.5	51,96
21057307	40445	13	51,96
21057308	40448	13.5	68,38
21057309	40451	14	55,51
21057310	40454	14.5	60,63
21057311	40457	15	60,63
21057312	40460	15.5	65,94
21057313	40463	16	65,94
21057314	40466	16.5	83,55
21057315	40469	17	79,41
21057316	40472	17.5	88,67
21057317	40475	18	95,22
21057318	40478	18.5	95,22
21057319	40481	19	95,22
21057320	40487	20	97,49
21057321	40493	21	97,49
21057322	40499	22	101,01
21057323	40505	23	105,51
21057324	40511	24	116,50
21057325	40517	25	123,66
21057326	40523	26	135,14
21057327	40529	27	147,34
21057328	40535	28	152,50
21057329	40547	30	201,84

3030 Juego de machos mano métrica HSS



HSS	DIN 352 1998-09	C 2-3h	Tol. 6H		α 10° ± 2	
Nº1 Desbaste Roughing Ebauche		Nº2 Semidesbaste Semiroughing Semi-Ebauche		Nº3 Acabado Finishing - Finition (Ref. 3010)		
Grupo 1 Subgr. 1.1	Grupo 5 Subgr. 5.1	Grupo 3 Subgr. 3.1/3.2	Grupo 6 Subgr. 6.1/6.2/6.3			

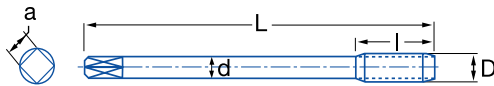

Ref. HSS	Código HSS	D mm	P	L mm	l mm	d mm	a mm	Z	€/ u.
113100	62531	M 2	0,40	36	8	2,8	2,1	3	29,17
113101	62534	M 2,5	0,45	40	9	2,8	2,1	3	29,17
113102	62537	M 3	0,50	40	11	3,5	2,7	3	16,51
113103	62540	M 3,5	0,60	45	13	4,0	3,0	3	19,45
113104	62543	M 4	0,70	45	13	4,5	3,4	3	16,51
113105	62546	M 4,5	0,75	50	16	6,0	4,9	3	29,17
113106	62549	M 5	0,80	50	16	6,0	4,9	3	17,50
113107	62552	M 6	1,00	56	19	6,0	4,9	3	17,50
113108	62555	M 7	1,00	56	19	6,0	4,9	3	21,39
113109	62561	M 8	1,25	56	22	6,0	4,9	4	21,39
113110	62567	M 9	1,25	63	22	7,0	5,5	4	34,99
113111	62573	M 10	1,50	70	24	7,0	5,5	4	26,27
113112	62576	M 11	1,50	70	24	8,0	6,2	4	43,73
113113	62579	M 12	1,75	75	28	9,0	7,0	4	36,93
113114	62582	M 13	1,75	75	28	9,0	7,0	4	67,06
113115	62585	M 14	2,00	80	30	11,0	9,0	4	40,84
113116	62588	M 15	2,00	80	32	12,0	9,0	4	81,65

Ref. HSS	Código HSS	D mm	P	L mm	l mm	d mm	a mm	Z	€/ u.
113117	62591	M 16	2,00	80	32	12,0	9,0	4	57,95
113118	62594	M 18	2,50	95	34	14,0	11,0	4	76,80
113119	62597	M 20	2,50	95	34	16,0	12,0	4	86,53
113120	62603	M 22	2,50	100	34	18,0	14,5	4	115,70
113121	62606	M 24	3,00	110	38	18,0	14,5	4	135,59
113122	62609	M 27	3,00	110	38	20,0	16,0	4	174,49
113123	62612	M 30	3,50	125	45	22,0	18,0	4	223,56
113124	62615	M 33	3,50	125	50	25,0	20,0	4	281,90
113125	62618	M 36	4,00	150	56	28,0	22,0	4	359,63
113126	62621	M 39	4,00	150	60	32,0	24,0	4	402,46
113127	62624	M 42	4,50	150	60	32,0	24,0	4	503,54
113128	73760	M 45	4,50	160	65	36,0	29,0	6	581,31
113129	62627	M 48	5,00	180	70	36,0	29	6	699,89
113130	76382	M 52	5,00	180	70	40,0	32	6	849,61
8000212	76383	M 56	5,5	200	85	45	35	6	1.310,20
8000213	76384	M 60	5,5	200	85	45	35	6	1.639,82

3405 Juego de machos mano, métrica HSS



Ref. HSS	Código HSS	Nº Piezas	Contenido	€/ u.
117600	69624	7 juegos de machos 7 brocas 1 gira-machos	M3 - M4 - M5 - M6 - M8 - M10 - M12 2,50 - 3,30 - 4,20 - 5,00 - 6,80 - 8,50 - 10,20 mm Nº 015 [M1-12]	105,11





3406 Juego de machos mano, métrica HSS



70527



38404



117950

Ref. HSS	Código HSS	Nº Piezas	Contenido	€/ u.
117900	70527	7 juegos de machos	M3 - M4 - M5 - M6 - M8 - M10 - M12	133,61
		7 cojinetes	M3 - M4 - M5 - M6 - M8 - M10 - M12	
		1 porta cojinetes	∅ 25 x 9	
		1 gira-machos	Nº 015	
		1 galga	Criqué Nº 1 (M3-10)	
117925	38404	11 juegos de machos	M3 - M4 - M5 - M6 - M8 - M10 - M12 - M14 - M16 - M18 - M20	399,59
		11 cojinetes	M3 - M4 - M5 - M6 - M8 - M10 - M12 - M14 - M16 - M18 - M20	
		6 porta cojinetes	20 x 5 - 20 x 7 - 25 x 9 - 30 x 11 - 38 x 14 - 45 x 18	
		2 gira-machos	Nº 1 - Nº 3	
117950	38981	1 galga		195,99
		7 juegos de machos	M3 - M4 - M5 - M6 - M8 - M10 - M12	
		7 cojinetes	M3 - M4 - M5 - M6 - M8 - M10 - M12	
		7 brocas	∅ 2,5 - 3,3 - 4,2 - 5,0 - 6,8 - 8,5 - 10,2	
		5 porta cojinetes	20 x 5 - 20 x 7 - 25 x 9 - 30 x 11 - 38 x 14	
		2 gira-machos	Nº 1 - Nº 2	
		1 gira-machos	Criqué Nº 1	

Juego de machos de roscar a mano



Juego de tres piezas constituido por primer macho, segundo macho y macho finalizador. Rosca métrica ISO. Hss, tipo N, tolerancia ISO 2 6H. Agujero ciego y pasante.



Ref.	Código	D mm	Paso mm	Longitud mm	Mango cuadrado mm	∅ agujero núcleo mm	∅ Mango mm	€/ u.
8004834	99-50401	M3	0,5	40	2,7	2,5	3,5	13,09
8004835	99-50402	M4	0,7	45	3,4	3,3	4,5	13,09
8004836	99-50403	M5	0,8	50	4,9	4,2	6	14,74
8004837	99-50404	M6	1	50	4,9	5	6	14,74
8004838	99-50405	M8	1,25	56	4,9	6,8	6	20,76
8004839	99-50406	M10	1,5	70	5,5	8,5	7	26,74
8004840	99-50407	M12	1,75	75	7	10,2	9	36,05
8004841	99-50408	M14	2	80	9	12	11	39,31
8004842	99-50409	M16	2	80	9	14	12	50,79
8004843	99-50410	M18	2,5	95	11	15,5	14	69,33
8004844	99-50411	M20	2,5	95	12	17,5	16	78,08

3032 Juego de machos mano, Whitworth HSS

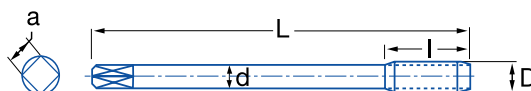

HSS	DIN 352	C 2-3h		α 10° ± 2	Nº1 Desbaste Roughing Ebauche	Nº2 Semidesbaste Semiroughing Semi-Ebauche	Nº3 Acabado Finishing - Finition (Ref. 3012)
-----	---------	--------	--	------------------	-------------------------------------	--	--

Ref. HSS	Código HSS	D mm	Hilos	Longitud mm	l mm	d mm	a mm	Z	€/ u.	Ref. HSS	Código HSS	D mm	Hilos	Longitud mm	l mm	d mm	a mm	Z	€/ u.
118400	62663	W 3/32	48	36	10	2,8	2,1	3	28,15	118408	62681	W 7/16	14	70	24	8,0	6,2	4	44,96
118401	62642	W 1/8	40	40	12	3,5	2,7	3	22,91	118409	62630	W 1/2	12	75	29	9,0	7,0	4	49,67
118402	62675	W 5/32	32	45	14	4,5	3,4	3	22,91	118410	62687	W 9/16	12	80	30	11,0	9,0	4	67,11
118403	62660	W 3/16	24	50	18	6,0	4,9	3	22,91	118411	62666	W 5/8	11	80	32	12,0	9,0	4	77,63
118404	62684	W 7/32	24	50	18	6,0	4,9	3	34,63	118412	62645	W 3/4	10	95	40	14,0	11,0	4	110,49
118405	62633	W 1/4	20	50	19	6,0	4,9	3	26,06	118413	62678	W 7/8	9	100	40	18,0	14,5	4	137,22
118406	62669	W 5/16	18	56	22	6,0	4,9	4	31,02	118414	62693	W 1"	8	110	50	18,0	14,5	4	169,43
118407	62654	W 3/8	16	70	24	7,0	5,5	4	34,33	118415	62702	W 1 1/8	7	132	56	22,0	18,0	4	251,18

3500 Cojinete HSS, Metrica



Ref.	Código	D mm	P	€/ u.	Ref.	Código	D mm	P	€/ u.	Ref.	Código	D mm	P	€/ u.
21057352	63191	M2	0,40	26,01	21057377	77046	M11	1,25	62,08	21057402	63290	M20	2,00	84,23
21057353	75001	M2,5	0,45	26,01	21057378	63230	M11	1,50	42,02	21057403	63293	M20	2,50	46,01
21057354	63194	M3	0,50	22,02	21057379	63233	M12	1,00	57,89	21057404	77066	M22	1,00	114,22
21057355	63197	M3,5	0,60	26,01	21057380	63236	M12	1,25	57,89	21057405	63296	M22	1,50	98,28
21057356	77025	M4	0,50	35,78	21057381	63239	M12	1,50	51,75	21057406	63299	M22	2,00	109,32
21057357	63200	M4	0,70	22,02	21057382	63242	M12	1,75	34,01	21057407	63302	M22	2,50	68,04
21057358	77028	M4,5	0,75	24,03	21057383	77049	M13	1,00	48,47	21057408	77069	M24	1,00	109,32
21057359	77029	M5	0,50	38,42	21057384	77050	M13	1,50	50,96	21057409	77070	M24	1,50	98,28
21057360	63203	M5	0,80	22,02	21057385	63251	M14	1,00	59,39	21057410	63308	M24	2,00	109,33
21057361	77034	M6	0,50	38,42	21057386	63254	M14	1,25	63,26	21057411	63311	M24	3,00	68,04
21057362	77035	M6	0,75	34,51	21057387	63257	M14	1,50	54,09	21057412	77072	M25	1,00	147,34
21057363	63206	M6	1,00	22,02	21057388	63260	M14	2,00	34,01	21057413	77073	M25	1,50	133,57
21057364	77037	M7	0,75	24,32	21057389	75307	M15	1,00	55,13	21057414	77075	M26	1,00	159,51
21057365	63209	M7	1,00	24,03	21057390	77053	M15	1,50	74,14	21057415	77076	M26	1,50	135,15
21057366	77038	M8	0,50	37,41	21057391	63266	M16	1,00	80,33	21057416	70103	M27	1,00	117,21
21057367	77039	M8	0,75	37,41	21057392	77054	M16	1,25	52,00	21057417	77656	M27	1,50	148,59
21057368	63212	M8	1,00	37,41	21057393	63269	M16	1,50	74,28	21057418	77079	M27	2,00	161,62
21057369	63215	M8	1,25	24,03	21057394	63272	M16	2,00	46,01	21057419	63314	M27	3,00	102,04
21057370	77041	M9	1,00	41,62	21057395	77057	M18	1,00	84,01	21057420	77081	M28	1,50	105,80
21057371	63218	M9	1,25	32,01	21057396	77058	M18	1,25	67,99	21057421	77082	M30	1,00	124,23
21057372	77043	M10	0,75	58,21	21057397	63278	M18	1,50	74,28	21057422	77083	M30	1,50	148,55
21057373	63221	M10	1,00	45,75	21057398	63281	M18	2,00	84,01	21057423	75310	M30	2,00	165,91
21057374	63224	M10	1,25	49,65	21057399	63284	M18	2,50	46,01	21057424	63317	M30	3,50	102,04
21057375	63227	M10	1,50	32,01	21057400	77061	M20	1,00	83,64					
21057376	77045	M11	1,00	56,93	21057401	63287	M20	1,50	76,66					



Cojinete HSS, Metrica



M. HSS. EN 22568. DIN 13 6g. Forma pre-ranurada cerrada. A partir de M3 corte inicial de mondar a ambos lados. Corte inicial sobre pasos 1,75. Nota: Para rosca métrica normal ISO DIN 13.



Ref.	Código	D mm	Paso mm	Ø exterior x altura mm	€/ u.
8004845	99-55412	M3	0,5	20 x 5	9,28
8004846	99-55413	M4	0,7	20 x 5	9,28
8004847	99-55414	M5	0,8	20 x 7	9,84
8004848	99-55415	M6	1	20 x 7	9,84
8004849	99-55416	M8	1,25	25 x 9	10,36
8004850	99-55417	M10	1,5	30 x 11	15,65

Ref.	Código	D mm	Paso mm	Ø exterior x altura mm	€/ u.
8004851	99-55418	M12	1,75	38 x 14	25,31
8004852	99-55419	M14	2	38 x 14	25,31
8004853	99-55420	M16	2	45 x 18	40,04
8004854	99-55421	M18	2,5	45 x 18	40,04
8004855	99-55422	M20	2,5	45 x 18	40,04

3500 Juego de cojinetes HSS, Metrica



Ref.	Código	Contenido	€/ u.
21057351	56518	M3-M12	178,13



3912 Giramachos T+Crique



Modelo íntegro en acero cromado. Carraca reversible para movimiento a la derecha, movimiento a la izquierda o fijo. Con mordazas templadas, de sujeción paralela. Maneral de cruceta reajustable.



Ref.	Código	Anchura interior cuadrado mm	Longitud mm	Para mangos roscados según DIN	Para mangos roscados según ISO	€/ u.
21057425	25340	2,0-5,0	85	M 3-8	M 1-6	23,05
21057426	25341	2,0-5,0	250	M 3-8	M 1-6	31,31
21057427	25342	4,6-8,0	110	M 5-12	M 6-12	36,35
21057428	25343	4,6-8,0	300	M 5-12	M 6-12	43,35



3150 Macho helicoidal máquina métrica forma C HSSE

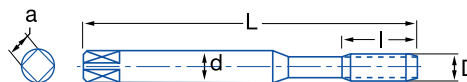

HSSE 5%Co	DIN 371	C 2-3h	35°	Tol. 6H	α $10^\circ \pm 2$	60°
--------------	------------	-----------	-----	------------	------------------------------	-----

Ref. HSSE	Código HSSE	D mm	P	L mm	l mm	d mm	a mm	Z	€/ u.
114200	63050	M 3	0,50	56	5	3,5	2,7	3	12,57
114201	63053	M 3,5	0,60	56	6	4,0	3,0	3	18,48
114202	63056	M 4	0,70	63	7	4,5	3,4	3	12,57
114203	63059	M 5	0,80	70	8	6,0	4,9	3	11,99
114204	63062	M 6	1,00	80	10	6,0	4,9	3	13,16
114205	63065	M 7	1,00	80	10	7,0	5,5	3	20,52
114206	63071	M 8	1,25	90	13	8,0	6,2	3	15,05
114207	63083	M 10	1,50	100	15	10,0	8,0	3	17,84

3200 Macho recto máquina métrica forma B y 3210 Macho recto máquina métrica forma C

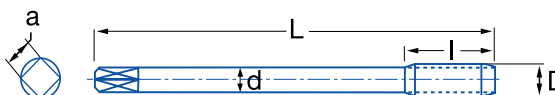

HSSE 5%Co	M DIN 376	MF DIN 374	B 3,5-5h	GUN	Tol. 6H	α $10-12^\circ$	60°
--------------	--------------	---------------	-------------	-----	------------	---------------------------	-----

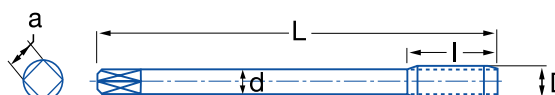

HSSE 5%Co	M	M DIN 376	MF DIN 374	C 2-3h	Tol. 6H	α $10^\circ \pm 2$	60°
--------------	---	--------------	---------------	-----------	------------	------------------------------	-----

Ref. 3200 HSSE	Código 3200 HSSE	€/ u. 3200 HSSE	Ref. 3210 HSSE	Código 3210 HSSE	€/ u. 3210 HSSE	D mm	P	L mm	l mm	d mm	a mm	Z
114300	70090	10,18	114400	69993	9,41	M 3	0,50	63	11	2,2	-	3
114301	70092	10,31	114401	69850	9,56	M 4	0,70	70	13	2,8	2,1	3
114302	70093	10,31	114402	69994	9,56	M 5	0,80	80	16	3,5	2,7	3
114303	70095	11,32	114403	69996	10,89	M 6	1,00	80	19	4,5	3,4	3
114304	70224	17,98	114404	70144	15,97	M 7	1,00	90	19	5,5	4,3	3
114305	70096	12,71	114405	69997	12,25	M 8	1,25	100	22	6,0	4,9	3
114306	70098	15,66	114406	69999	13,95	M 10	1,50	100	24	7,0	5,4	3
114307	70225	30,21				M 11	1,50	110	24	8,0	6,2	3
114308	70183	19,29	114408	70117	16,63	M 12	1,75	110	29	9,0	7,0	3
114309	70185	30,94	114409	70119	28,15	M 14	2,00	110	30	11,0	9,0	3
114310	70186	36,42	114410	70120	33,10	M 16	2,00	125	32	12,0	9,0	3
114311	75215	51,57	114411	70122	47,60	M 18	2,50	140	34	14,0	11,0	3
114312	70189	55,76	114412	70123	50,69	M 20	2,50	140	34	16,0	12,0	3
114313	70212	67,45	114413	70146	61,35	M 22	2,50	160	34	18,0	14,5	3
114314	70213	80,20	114414	70147	73,46	M 24	3,00	160	38	18,0	14,5	4
114315	70215	100,50	114415	70149	91,70	M 27	3,00	180	38	20,0	16,0	4
114316	70216	129,14	114416	70150	117,42	M 30	3,50	180	45	22,0	18,0	4
114317	70218	162,43	114417	70152	141,14	M 33	3,50	200	50	25,0	20,0	4
114318	70219	198,44	114418	70153	180,46	M 36	4,00	56	56	28,0	22,0	4

03



Macho de roscar a máquina forma B y forma C



Rosca métrica ISO DIN 13, forma B con corte inicial. Ranurado recto



Ref.	Código	€/ u.	Ref.	Código	€/ u.	D mm	Paso mm	d mm	l mm	Mango cua-drado mm	Dientes	Longitud mm
8004867	99-50434	13,83	8004856	99-50423	11,48	M 3	0,50	2,2	11	-	3	56
8004868	99-50435	13,83	8004857	99-50424	11,66	M 4	0,70	2,8	13	2,1	3	63
8004869	99-50436	15,30	8004858	99-50425	13,48	M 5	0,80	3,5	16	2,7	3	70
8004870	99-50437	16,38	8004859	99-50426	13,65	M 6	1,00	4,5	19	3,4	3	80
8004871	99-50438	20,93	8004860	99-50427	17,47	M 8	1,25	6,0	22	4,9	3	90
8004872	99-50439	28,21	8004861	99-50428	23,49	M 10	1,50	7,0	24	5,5	3	100
8004873	99-50440	32,20	8004862	99-50429	28,21	M 12	1,75	9,0	29	7,0	3	110
8004874	99-50441	38,22	8004863	99-50430	34,23	M 14	2,00	11,0	30	9,0	3	110
8004875	99-50442	43,68	8004864	99-50431	38,22	M 16	2,00	12,0	32	9,0	3	110
8004876	99-50443	73,71	8004865	99-50432	70,07	M 18	2,50	14,0	34	11,0	3	125
8004877	99-50444	111,02	8004866	99-50433	111,02	M 20	2,50	16,0	34	12,0	3	140

3200 Macho recto máquina métrica fina forma B y 3210 Macho recto máquina métrica fina forma C

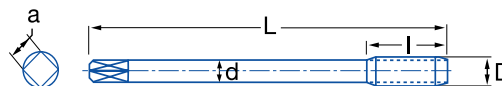

HSSE 5%Co	M DIN 376	MF DIN 374	B 3,5-5h	GUN	Tol. 6H	α 10-12°	
-----------	-----------	------------	----------	-----	---------	-----------------	--

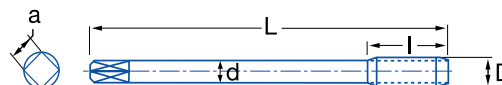

HSSE 5%Co	M	M DIN 376	C 2-3h	Tol. 6H	α 10° ± 2	
-----------	---	-----------	--------	---------	------------------	--

Ref. 3200 HSSE	Código 3200 HSSE	€/ u. 3200 HSSE	Ref. 3210 HSSE	Código 3210 HSSE	€/ u. 3210 HSSE	D mm	P	L mm	l mm	d mm	a mm	Z
			114800	70365	23,08	MF 4	0,50	70	10	2,8	2,1	3
			114801	70366	23,76	MF 5	0,50	80	12	3,5	2,7	3
			114802	74951	28,24	MF 6	0,50	80	14	4,5	3,4	3
			114803	70368	18,72	MF 6	0,75	80	14	4,5	3,4	3
			114804	70369	31,91	MF 8	0,50	80	13	6	4,9	3
114705	70267	26,22	114805	70305	22,81	MF 8	0,75	90	19	6	4,9	3
114706	70248	21,26	114806	70306	19,36	MF 8	1,00	90	22	6	4,9	3
			114807	70371	28,24	MF 9	1,00	90	22	7	5,5	3
			114808	70372	34,81	MF 10	0,75	90	20	7	5,5	3
114709	70249	23,69	114809	70308	21,47	MF 10	1,00	100	20	7	5,5	3
114710	70251	28,24	114810	70309	24,57	MF 10	1,25	100	24	7	5,5	3
			114811	70374	35,68	MF 11	1,00	100	20	8	6,2	3
114712	70252	31,20	114812	70312	28,34	MF 12	1,00	100	22	9	7,0	3
114713	70254	31,51	114813	70314	28,69	MF 12	1,25	100	22	9	7,0	3
114714	70255	28,15	114814	70315	25,68	MF 12	1,50	100	22	9	7,0	3
114715	70281	47,83	114815	70317	43,50	MF 14	1,00	100	22	11	9,0	3
114716	70257	41,92	114816	70318	38,45	MF 14	1,25	100	22	11	9,0	3
114717	70258	33,32	114817	70320	30,27	MF 14	1,50	100	22	11	9,0	3
			114818	70378	54,33	MF 15	1,00	100	22	12	9,0	3
			114819	70380	54,10	MF 16	1,00	100	22	12	9,0	3



3200 Macho recto máquina métrica fina forma B y
3210 Macho recto máquina métrica fina forma C

Ref. 3200 HSSE	Código 3200 HSSE	€/ u. 3200 HSSE	Ref. 3210 HSSE	Código 3210 HSSE	€/ u. 3210 HSSE	D mm	P	L mm	l mm	d mm	a mm	Z
114720	70260	41,65	114820	70323	37,87	MF 16	1,50	110	22	12	9,0	3
114721	70284	66,64	114821	70326	60,58	MF 18	1,00	110	25	14	11,0	3
114722	70261	52,11	114822	70327	47,38	MF 18	1,50	125	25	14	11,0	3
114723	70285	67,25	114823	70329	61,13	MF 18	2,00	125	34	14	11,0	3
114724	70287	87,95	114824	70330	80,03	MF 20	1,00	125	25	16	12,0	3
114725	70263	58,92	114825	70332	53,62	MF 20	1,50	140	25	16	12,0	3
114726	70288	77,27	114826	70333	70,24	MF 20	2,00	125	34	16	12,0	3
			114827	70381	89,70	MF 22	1,00	125	25	18	14,5	3
114728	75216	70,99	114828	75023	64,55	MF 22	1,50	140	25	18	14,5	4
114729	70290	112,50	114829	70335	89,70	MF 22	2,00	140	34	18	14,5	4
			114830	70383	97,77	MF 24	1,00	140	28	18	14,5	4
114731	70264	87,27	114831	70336	79,31	MF 24	1,50	140	28	18	14,5	4
114732	70291	110,31	114832	70338	100,25	MF 24	2,00	140	28	18	14,5	4
			114833	70384	116,85	MF 25	1,50	140	28	18	14,5	4
114734	70293	112,15	114834	70339	106,98	MF 26	1,50	140	28	18	14,5	4
			114835	70386	117,03	MF 27	1,50	140	28	20	16,0	4
114736	70294	152,97	114836	70341	139,05	MF 27	2,00	140	28	20	16,0	4
114737	70296	128,27	114837	70342	116,85	MF 28	1,50	150	28	20	16,0	4
			114838	70387	149,46	MF 30	1,00	150	28	22	18,0	4
114739	70266	133,96	114839	70344	121,79	MF 30	1,50	150	28	22	18,0	4
			114840	70389	150,75	MF 30	2,00	150	28	22	18,0	4
114741	70297	160,33	114841	70345	145,83	MF 32	1,50	160	28	22	18,0	4
114742	70299	183,30	114842	70347	167,19	MF 33	1,50	160	30	25	20,0	4
114743	70300	264,84	114843	70348	284,55	MF 33	2,00	170	30	25	20,0	4
114744	70302	212,34	114844	70350	192,98	MF 35	1,50	180	30	28	22,0	4
			114845	70390	273,13	MF 42	1,50	180	30	32	24,0	6
114746	70303	372,05	114846	70351	338,24	MF 45	1,50	63	32	36	29,0	4

03

3230 Macho máquina métrica materiales duros TIALN

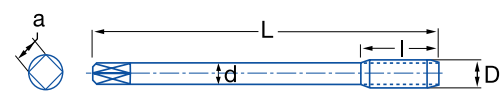

PMX
TIALN
DIN 376
B 3,5-5h
Tol. 6H
GUN
α 2-4°

Ref. TIALN	Código TIALN	D mm	P	L mm	l mm	d mm	a mm	Z	€/ u.
115200	16394	M 12	1,75	110	29	9	7	3	46,72
115201	16395	M 14	2,00	110	30	11	9	3	64,66
115202	16396	M 16	2,00	125	32	12	9	3	79,05

Ref. TIALN	Código TIALN	D mm	P	L mm	l mm	d mm	a mm	Z	€/ u.
115203	13216	M 18	2,50	140	34	14	11	3	148,40
115204	13217	M 20	2,50	56	34	16	12	3	170,68

3143 Macho máquina métrica materiales blandos HSSE

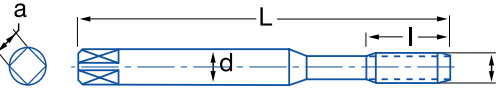
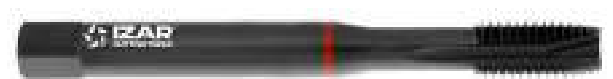

HSSE V
DIN 371
B 3,5-5h
GUN
Tol. 6H
α 10-12°

Ref. HSSE-V	Código HSSE-V	D mm	P	L mm	l mm	d mm	a mm	Z	€/ u.
115300	69532	M 3	0,50	63	11	3,5	2,7	3	14,16
115301	69534	M 4	0,70	70	13	4,5	3,4	3	14,47
115302	69535	M 5	0,80	80	16	6	4,9	3	14,47

Ref. HSSE-V	Código HSSE-V	D mm	P	L mm	l mm	d mm	a mm	Z	€/ u.
115303	69537	M 6	1,00	90	17	6	4,9	3	15,91
115304	69538	M 8	1,25	100	20	8	6,2	3	17,84
115305	15672	M 10	1,50	56	24	10	8	3	20,56





3149 Macho máquina métrica INOX TIN

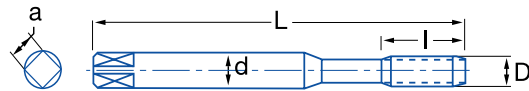

HSSE 5% Co	TIN	DIN 371	B 3,5-5h	GUN	Tol. 6H	α 10-12°		
---------------	-----	------------	-------------	-----	------------	--------------------	--	--

Ref. TIN	Código TIN	D mm	P	L mm	l mm	d mm	a mm	Z	€/u.
116100	21834	M 3	0,50	63	11	3,5	2,7	3	18,53
116101	21835	M 4	0,70	70	13	4,5	3,4	3	18,77
116102	21836	M 5	0,80	80	16	6,0	4,9	3	19,46

Ref. TIN	Código TIN	D mm	P	L mm	l mm	d mm	a mm	Z	€/u.
116103	21837	M 6	1,00	90	17	6,0	4,9	3	19,59
116104	21838	M 8	1,25	100	20	8,0	6,2	3	22,81
116105	21839	M 10	1,50	90	24	10,0	8,0	3	26,55

3249 Macho máquina métrica INOX TIN

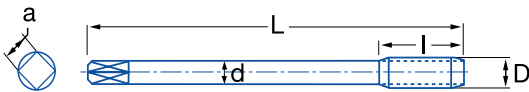
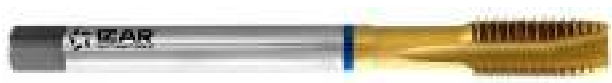

HSSE 5% Co	TIN	DIN 376	B 3,5-5h	GUN	Tol. 6H	α 10-12°		
---------------	-----	------------	-------------	-----	------------	--------------------	--	--

Ref.	Código	D mm	P	L mm	l mm	d mm	a mm	Z	€/u.
116200	21840	M 8	1,25	100	20	6	4,9	3	25,12
116201	21841	M 10	1,50	110	22	7	5,5	3	28,72
116202	21843	M 12	1,75	110	24	9	7,0	3	33,93
116203	21844	M 14	2,00	110	26	11	9,0	3	44,23

Ref.	Código	D mm	P	L mm	l mm	d mm	a mm	Z	€/u.
116204	21846	M 16	2,00	125	27	12	9,0	3	48,77
116205	21847	M 18	2,50	140	30	14	11,0	4	75,98
116206	21848	M 20	2,50	56	32	16	12,0	4	79,08

3159 Macho máquina métrica INOX TIN

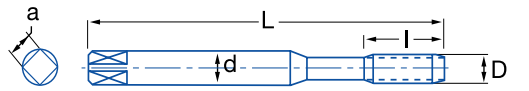

HSSE 5% Co	TIN	DIN 371	C 2-3h		Tol. 6H	α 10-12°		
---------------	-----	------------	-----------	--	------------	--------------------	--	--

Ref.	Código	D mm	P	L mm	l mm	d mm	a mm	Z	€/u.
116300	21849	M 3	0,50	63	5	3,5	2,7	3	20,16
116301	21850	M 4	0,70	70	7	4,5	3,4	3	20,16
116302	21851	M 5	0,80	80	8	6,0	4,9	3	20,63

Ref.	Código	D mm	P	L mm	l mm	d mm	a mm	Z	€/u.
116303	21852	M 6	1,00	90	10	6,0	4,9	3	21,54
116304	21853	M 8	1,25	100	13	8,0	6,2	3	24,92
116305	21854	M 10	1,50	90	15	10,0	8,0	3	29,29

3259 Macho máquina métrica INOX TIN

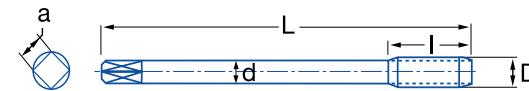
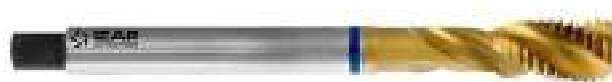

HSSE 5% Co	TIN	DIN 376	C 2-3h		Tol. 6H	α 10-12°		
---------------	-----	------------	-----------	--	------------	--------------------	--	--

Ref.	Código	D mm	P	L mm	l mm	d mm	a mm	Z	€/u.
116400	21855	M 8	1,25	100	13	6	4,9	3	26,40
116401	21856	M 10	1,50	110	15	7	5,5	3	33,04
116402	21857	M 12	1,75	110	18	9	7,0	3	38,46
116403	21858	M 14	2,00	110	20	11	9,0	4	48,06

Ref.	Código	D mm	P	L mm	l mm	d mm	a mm	Z	€/u.
116404	21859	M 16	2,00	125	20	12	9,0	4	52,82
116405	21860	M 18	2,50	140	25	14	11,0	4	76,23
116406	21861	M 20	2,50	56	25	16	12,0	4	78,78

3153 Macho materiales aleados helicoidal máquina métrica forma C HSSE

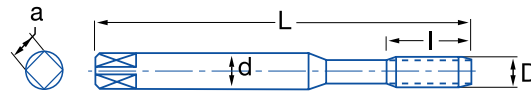

HSSE V	DIN 371	C 2-3h	40°	Tol. 6H	α 6° ± 1		
--------	---------	--------	-----	---------	-----------------	--	--

Ref.	Código	M	P	L mm	l mm	d mm	a mm	Z	€/u.
8000406	69412	M3	0,5	56	5	3,5	2,7	3	15,59
8000407	69414	M4	0,7	63	7	4,5	3,4	3	15,94
8000408	69415	M5	0,8	70	8	6	4,9	3	15,94

Ref.	Código	M	P	L mm	l mm	d mm	a mm	Z	€/u.
8000409	69483	M6	1	80	10	6	4,9	3	17,48
8000410	69484	M8	1,25	90	13	8	6,2	3	19,62
8000411	69519	M10	1,5	100	15	10	8	3	22,61

3160 Macho multifunción helicoidal máquina métrica forma C HSSE

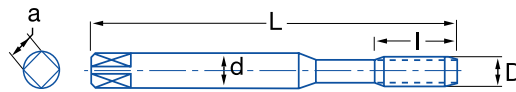

HSSE V	TIN	DIN 371	C 2-3h	35°	Tol. 6H	α 6° ± 2		
--------	-----	---------	--------	-----	---------	-----------------	--	--

Ref.	Código	M	P	L mm	l mm	d mm	a mm	Z	€/u.
8000412	28052	M3	0,5	56	11	3,5	2,7	3	26,75
8000413	28053	M4	0,7	63	13	4,5	3,4	3	26,75
8000414	28054	M5	0,8	70	16	6	4,9	3	27,41

Ref.	Código	M	P	L mm	l mm	d mm	a mm	Z	€/u.
8000415	28055	M6	1	80	17	6	4,9	3	28,60
8000416	28056	M8	1,25	90	20	8	6,2	3	33,18
8000417	28057	M10	1,5	100	24	10	8	3	39,05

3162 Macho laminación recto máquina métrica forma B HSSE

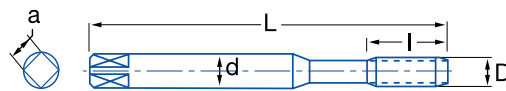

PMX	TIN	DIN 2174	C 2-3h	Tol. 6HX	60°
-----	-----	----------	--------	----------	-----

Ref.	Código	M	P	L mm	l mm	d mm	a mm	Z	€/u.
8000424	69345	M3	0,5	56	9	3,5	2,7	4	41,19
8000425	69346	M4	0,7	63	12	4,5	3,4	5	41,19
8000426	69348	M5	0,8	70	13	6	4,9	5	41,19
8000427	69349	M6	1	80	15	6	4,9	5	44,40
8000428	69644	M8	1	90	22	8	6,2	5	63,95
8000429	69351	M8	1,25	90	22	8	6,2	5	51,86
8000430	69645	M10	1,25	100	24	10	8	5	68,56

Ref.	Código	M	P	L mm	l mm	d mm	a mm	Z	€/u.
8000431	69352	M10	1,5	100	24	10	8	5	57,64
8000432	69648	M12	1,25	100	22	9	7	5	88,96
8000433	69353	M12	1,75	110	28	9	7	5	67,86
8000434	69650	M14	1,5	100	22	11	9	5	98,18
8000435	69354	M14	2	110	25	11	9	5	93,50
8000436	69658	M16	1,5	100	22	12	9	5	124,40
8000437	69355	M16	2	110	25	12	9	5	113,62

Reparador de roscas interiores



Equipado con cuchilla para roscas métricas 60°.

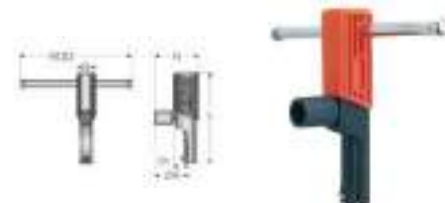

Ref.	Código	B mm	Capacidad Ø mm	H mm	Longitud mm	Ø R	ROD	Ø r	€/u.
2122554	NES21	18	8 a 11	45	109	38	116	16	127,50
2122555	NES22	18	12 a 16	45	109	39	116	17	131,14
2122556	NES23	21	16 a 20	53	111	45	130	20	138,11
2122570	NES25	38	32 a 54	81	163	62	192	35	323,34
2122571	NES27	50	69 a 81	103	163	76	192	48	465,61

Ref.	Código	B mm	Capacidad Ø mm	H mm	Longitud mm	Ø R	ROD	Ø r	€/u.
2122572	NES28	50	82 a 95	118	163	82	192	54	522,70
2122573	NES29	50	96 a 108	132	163	88	192	61	579,59
2122557	NES24	27	22 a 32	64	136	54	161	27	184,18
2122558	NES26	50	32 a 68	92	163	70	192	41	459,68



03

Reparador de roscas exteriores



Equipado con cuchilla para roscas métricas 60°.



Ref.	Código	Capacidad Ø mm	H mm	Longitud mm	R	W	€ / u.
2122650	NES1A	M4 a M18	62	61	68	23	115,54
2122651	NES2	M17 a M38	110	105	117	32	167,54

Ref.	Código	Capacidad Ø mm	H mm	Longitud mm	R	W	€ / u.
2122652	NES3	M35 a M152	130	305	254	32	430,98
2122653	NEST	M4 a M13	Versión económica				48,98

Juego reparadores de roscas



Contienen cuchillas de repuesto.

Ref.	Código	Capacidad Ø mm	Contenido	€ / u.
2122750	NES1012	M4 a M18 - M8 a M16	NES1A NES21-22	365,56
2122751	NES1025	M4 a M38 - M8 a M32	NES1A-2 NES21-22-24-25	880,88



NES1012



NES1025

Fresa de metal duro cilíndrica ZYA



Tipo	Dentado 1	€ / u.	Dentado 3	€ / u.	Dentado 3 plus	€ / u.	Dentado 4	€ / u.	Dentado 5	€ / u.	Dentado Alu plus	€ / u.	Dentado Acero	€ / u.	Dentado Inox	€ / u.	Ø Mango mm	Ø de cabeza mm	L2	L1
ZYA 0210/3					2122667	13,94	2122681	15,55	2122692	13,99							3	2	10	40
ZYA 0313/3					2122668	14,19	2122682	15,72	2122693	14,06					2122710	16,77	3	3	13	43
ZYA 0607/3					2122669	15,78			2122694	15,45							3	6	7	37
ZYA 0613/3					2122670	15,76			2122695	15,78					2122711	19,88	3	6	13	43
ZYA 0413/6					2122671	22,92	2122683	26,88	2122696	25,46							6	4	13	55
ZYA 0616/6			2122662	23,92	2122672	21,35	2122684	22,94	2122697	22,25	2122702	26,48	2122705	23,35	2122712	24,26	6	6	16	55
ZYA 0820/6			2122663	56,06	2122673	28,99	2122685	34,06	2122698	29,75			2122706	30,95	2122713	32,13	6	8	20	60
ZYA 1013/6					2122674	35,10	2122686	38,52	2122699	33,24							6	10	13	53
ZYA 1020/6	2122660	47,53	2122664	36,87	2122675	36,21	2122687	42,77	2122700	38,35			2122707	39,36	2122714	41,31	6	10	20	60
ZYA 1025/6					2122676	44,12	2122688	50,69									6	10	25	65
ZYA 1225/6	2122661	52,83	2122665	49,56	2122677	49,56	2122689	53,12	2122701	49,56	2122703	56,56	2122708	52,55	2122715	55,22	6	12	25	65
ZYA 1625/6					2122679	55,75	2122691	71,25					2122709	61,32			6	16	25	65
ZYA 1225/8					2122678	46,97					2122704	56,09					8	12	25	65
ZYA 1625/8					2122680	60,31											8	16	25	65

Fresa de metal duro cilíndrica con dentado frontal ZYA-S



Tipo	Dentado 3	€ / u.	Dentado 3 plus	€ / u.	Dentado 4	€ / u.	Dentado 5	€ / u.	Dentado Acero	€ / u.	Dentado Cast	€ / u.	Dentado Cast	€ / u.	L2	L1
ZYA-S 0210/3			2122809	14,69	2122821	16,88	2122829	14,69					3	2	10	40
ZYA-S 0313/3			2122822	13,49	2122810	13,90	2122830	13,41					3	3	13	43
ZYA-S 0413/3			2122813	23,76									6	4	13	55
ZYA-S 0607/3			2122811	17,69			2122831	17,69					3	6	7	37
ZYA-S 0613/3			2122812	17,41	2122823	20,42	2122832	18,07					3	6	13	43
ZYA-S 0616/6									2122841	28,32	2122846	28,70	6	6	16	55
ZYA-S 0820/6	2122805	36,38	2122814	30,95	2122824	38,03	2122833	33,40	2122842	34,04			6	8	20	60
ZYA-S 1013/6			2122815	37,21									6	10	13	53
ZYA-S 1020/6	2122806	42,21	2122816	42,21	2122825	49,02	2122834	42,52	2122843	45,09	2122847	43,96	6	10	20	60
ZYA-S 1025/6			2122817	49,06	2122826	56,60							6	10	25	65
ZYA-S 1225/6	2122807	55,06	2122818	55,06	2122827	59,34	2122835	53,88	2122844	58,23	2122848	56,88	6	12	25	65
ZYA-S 1225/8			2122819	51,21									8	12	25	65
ZYA-S 1625/6	2122808	67,23	2122820	67,23	2122828	79,78	2122836	69,33	2122845	72,76			6	16	25	65

Fresa de metal duro cilíndrica con dentado frontal ZYA-S. Dentado ALLROUND



Fresa cilíndrica según DIN 8032 con dentado en el perímetro y en la parte frontal.

Ref.	Código	Tipo	Ø Mango mm	Ø de cabeza mm	L2	L1	€ / u.
20035893	ZYAS 0616 ALLROUND M6	ZYAS 0616/6	6	6	16	55	26,94
20035894	ZYAS 0820 ALLROUND M6	ZYAS 0820/6	6	8	20	60	32,03
20035895	ZYAS 1020 ALLROUND M6	ZYAS 1020/6	6	10	20	60	42,19
20035896	ZYAS 1225 ALLROUND M6	ZYAS 1225/6	6	12	25	65	54,27
20035897	ZYAS 1625 ALLROUND M6	ZYAS 1625/6	6	16	25	65	68,24



Fresa de metal duro cilíndrica redonda WRC



Tipo	Dentado 1	€ / u.	Dentado 3	€ / u.	Dentado 3 plus	€ / u.	Dentado 4	€ / u.	Dentado 5	€ / u.	Ø Mango mm	Ø de cabeza mm	L2	L1
WRC 0210/3					2122860	14,86	2122873	17,41	2122884	14,19	3	2	10	40
WRC 0313/3					2122861	15,03	2122874	15,63	2122885	13,74	3	3	13	43
WRC 0613/3					2122862	17,91	2122875	19,73	2122886	19,77	3	6	13	43
WRC 0413/6					2122863	24,13	2122876	27,12			6	4	13	55
WRC 0616/6	2122849	27,53	2122854	29,12	2122864	27,53	2122877	29,31	2122887	28,52	6	6	16	55
WRC 0820/6	2122850	33,82	2122855	36,94	2122865	31,34	2122878	36,11	2122888	36,89	6	8	20	60
WRC 1020/6	2122851	41,79	2122856	40,41	2122866	38,44	2122879	44,47			6	10	20	60
WRC 1025/6			2122857	48,90	2122868	45,88	2122880	52,85			6	10	25	65
WRC 1225/6	2122852	60,40	2122858	55,05	2122869	55,76	2122881	55,58	2122890	57,90	6	12	25	65
WRC 1625/6	2122853	71,52	2122859	69,02	2122871	69,02	2122883	79,45			6	16	25	65
WRC 1020/8					2122867	42,96					8	10	20	60
WRC 1225/8					2122870	59,16	2122882	65,98			8	12	25	65
WRC 1625/8					2122872	67,99					8	16	25	65

Tipo	Dentado Alu	€ / u.	Dentado Alu plus	€ / u.	Dentado Acero	€ / u.	Dentado Inox	€ / u.	Dentado Cast	€ / u.	Ø Mango mm	Ø de cabeza mm	L2	L1
WRC 0313/3							2123022	17,34			3	3	13	43
WRC 0613/3							2123023	23,02			3	6	13	43
WRC 0616/6			2123014	31,05	2123017	29,96	2123024	31,72	2123028	29,55	6	6	16	55
WRC 0820/6					2123018	35,85	2123025	35,75			6	8	20	60
WRC 1020/6					2123019	42,72	2123026	43,49	2123029	43,29	6	10	20	60
WRC 1225/6	2123011	62,16	2123015	63,79	2123020	59,01	2123027	60,69	2123030	59,45	6	12	25	65
WRC 1625/6					2123021	73,68					6	16	25	65



03

Fresa de metal duro forma obús SPG

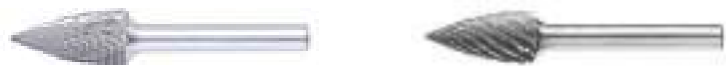

Tipo	Dentado 1	€ / u.	Dentado 3	€ / u.	Dentado 3 plus	€ / u.	Dentado 4	€ / u.	Dentado 5	€ / u.	Dentado Acero	€ / u.	Dentado Inox	€ / u.	Dentado Cast	€ / u.	Ø Mango mm	Ø de cabeza mm	L2	L1
SPG 0307/3					2123042	14,61	2123053	15,22	2123062	14,17							3	3	7	37
SPG 0313/3					2123043	14,41	2123054	16,72	2123063	14,54							3	3	13	43
SPG 0613/3					2123044	16,75	2123055	18,73	2123064	16,60							3	6	13	43
SPG 0618/6			2123037	26,68	2123045	25,30	2123056	27,33	2123065	25,17	2123069	27,82	2123074	28,90			6	6	18	55
SPG 0820/6											2123070	40,70	2123075	45,20			6	8	20	60
SPG 1020/6	2123032	42,12	2123038	43,00	2123046	37,34	2123057	40,69	2123066	40,02	2123071	43,99	2123076	45,79	2123079	44,46	6	10	20	60
SPG 1225/6			2123039	50,10	2123048	48,96	2123058	59,13	2123067	51,07	2123072	50,59	2123077	56,37	2123080	54,04	6	12	25	65
SPG 1230/6	2123034	53,66	2123040	56,37	2123050	52,18	2123060	56,83	2123068	54,05							6	12	30	70
SPG 1630/6	2123035	70,91	2123041	70,47	2123051	65,03	2123061	71,04			2123073	70,85					6	16	30	70
SPG 1020/8					2123047	45,01											8	10	20	60
SPG 1225/8					2123049	50,37											8	12	25	65
SPG 1630/8	2123036	69,34			2123052	69,34											8	16	30	70

Fresa de metal duro cilíndrica redonda WRC. Dentado ALLROUND



Fresa de forma redonda cilíndrica según DIN 8032. Combina las geometrías cilíndrica y esférica.

Ref.	Código	Tipo	Ø Mango mm	Ø de cabeza mm	L2	L1	€ / u.
20035903	WRC 0616 ALLROUND M6	WRC 0616/6	6	6	16	55	27,80
20035904	WRC 0820 ALLROUND M6	WRC 0820/6	6	8	20	60	33,88
20035905	WRC 1020 ALLROUND M6	WRC 1020/6	6	10	20	60	40,18
20035906	WRC 1225 ALLROUND M6	WRC 1225/6	6	12	25	65	56,58
20035907	WRC 1625 ALLROUND M6	WRC 1625/6	6	16	25	65	70,04



Fresa de metal duro forma llama B



Tipo	Ref.	€ / u.	Ref.	€ / u.	Ref.	€ / u.	Ø Mango mm	Ø de cabeza mm	L2	L1
B 0820/6			2122719	42,92			6	8	20	60
B 1025/6			2122720	50,80			6	10	25	65
B 1230/6	2122717	61,15	2122721	66,19			6	12	30	70
B 1230/6					2122722	60,87	6	12	30	70
B 1635/6	2122718	80,35					6	16	35	75



Fresa de metal duro para ángulos WKN



Tipo	Ref.	€ / u.	Ref.	€ / u.	Ref.	€ / u.	Ø Mango mm	Ø de cabeza mm	L2	L1
WKN 0307/3			2122726	14,19	2122728	14,19	3	3	7	37
WKN 0607/3			2122727	15,73	2122729	15,73	3	6	7	37
WKN 1213/6	2122724	52,32					6	12	13	53
WKN 1613/6	2122725	63,52					6	12	13	53



Fresa de metal duro forma gota TRE



Tipo	Ref.	€ / u.	Ref.	€ / u.	Ref.	€ / u.	Ref.	€ / u.	Ref.	€ / u.	Ref.	€ / u.	Ref.	€ / u.	Ø Mango mm	Ø de cabeza mm	L2	L1
TRE 0307/3			2123113	15,18			2123127	15,16			3	3	7	37				
TRE 0610/3			2123114	17,85			2123128	17,85			3	6	10	40				
TRE 0610/6			2123115	29,31			2123129	29,31			6	6	10	50				
TRE 0813/6			2123116	34,43	2123122	44,51	2123130	38,74	2123132	40,61	6	8	13	53				
TRE 1016/6			2123117	38,46	2123123	50,89			2123133	44,59	6	10	16	56				
TRE 1625/6										2123111	70,47	6	16	25	65			
TRE 1220/6	2123135	49,13	2123112	46,42	2123118	46,42	2123124	53,61	2123131	45,83	2123134	53,00	6	12	20	60		
TRE 1625/6					2123120	71,36	2123126	78,64			6	16	25	65				
TRE 1220/8					2123119	46,15					8	12	20	60				
TRE 1625/8					2123121	67,57					8	16	25	65				

Fresa de metal duro forma obús SPG. Dentado ALLROUND



Fresa forma obús según DIN 8032, punta achatada.

Ref.	Código	Tipo	Ø Mango mm	Ø de cabeza mm	L2	L1	€ / u.
20035912	SPG 0618 ALLROUND M6	SPG 0618/6	6	6	18	55	25,67
20035913	SPG 0820 ALLROUND M6	SPG 0820/6	6	8	20	60	38,37
20035914	SPG 1020 ALLROUND M6	SPG 1020/6	6	10	20	60	40,78
20035915	SPG 1225 ALLROUND M6	SPG 1225/6	6	12	25	65	49,69
20035916	SPG 1630 ALLROUND M6	SPG 1630/6	6	16	30	70	66,43



Fresa de metal duro forma gota TRE. Dentado ALLROUND



Fresa forma gota según DIN 8032 con dentado según DIN 8033.

Ref.	Código	Tipo	Ø Mango mm	Ø de cabeza mm	L2	L1	€ / u.
20035931	TRE 0813 ALLROUND M6	TRE 0813/6	6	8	13	53	37,07
20035932	TRE 1016 ALLROUND M6	TRE 1016/6	6	10	16	56	40,96
20035933	TRE 1220 ALLROUND M6	TRE 1220/6	6	12	20	60	47,08
20035934	TRE 1625 ALLROUND M6	TRE 1625/6	6	16	25	65	68,52



Fresa de metal duro forma árbol RBF



Ref.	Código	€ / u.	Tipo	Ø Mango mm	Ø de cabeza mm	L2	L1
2123137	RBF 0618 D3 M6	26,05	RBF 0618/6	6	6	18	55
2123138	RBF 0820 D3 M6	39,51	RBF 0820/6	6	8	20	60
2123139	RBF 1020 D3 M6	42,29	RBF 1020/6	6	10	20	60
2123140	RBF 1225 D3 M6	51,20	RBF 1225/6	6	12	25	65
2123141	RBF 1630 D3 M6	67,17	RBF 1630/6	6	16	30	70

Fresa de metal duro forma cónica apuntada SKM. Dentado Cast (Fundición)



Ref.	Código	Tipo	Ø mango mm	Ø de cabeza mm	L2	L1	€ / u.
2122748	SKM 1225 CAST M6	SKM 1225/6	6	12	25	65	53,98





Fresa de metal duro forma árbol RBF



Tipo	Dentado 3 plus	€/ u.	Dentado 4	€/ u.	Dentado 5	€/ u.	Ø Mango mm	Ø de cabeza mm	L2	L1
RBF 0307/3	2123142	14,65			2123157	14,20	3	3	7	37
RBF 0613/3	2123143	16,12	2123151	18,76	2123158	18,26	3	6	13	43
RBF 0618/6	2123144	26,09	2123152	29,18	2123159	25,64	6	6	18	55
RBF 0820/6	2123145	36,34	2123153	35,26			6	8	20	60
RBF 1020/6	2123146	44,27	2123154	49,00	2123160	43,17	6	10	20	60
RBF 1225/6	2123147	46,86	2123155	53,28	2123161	48,45	6	12	25	65
RBF 1630/6	2123149	67,85	2123156	74,95			6	16	30	70
RBF 1225/8	2123148	51,93					8	12	25	65
RBF 1630/8	2123150	69,18					8	16	30	70

Tipo	Dentado Alu	€/ u.	Dentado Acero	€/ u.	Dentado Inox	€/ u.	Dentado Cast	€/ u.	Ø Mango mm	Ø de cabeza mm	L2	L1
RBF 0313/3					2122739	19,99			3	3	13	43
RBF 0613/3					2122740	21,10			3	6	13	43
RBF 0618/6	2122730	31,63	2122734	27,61	2122741	28,38	2122745	27,82	6	6	18	55
RBF 0820/6			2122735	38,70	2122742	41,67			6	8	20	60
RBF 1020/6			2122736	46,84	2122743	48,82	2122746	47,99	6	10	20	60
RBF 1225/6	2122731	60,34	2122737	50,10	2122744	52,00	2122747	52,05	6	12	25	65
RBF 1630/6	2122733	84,83	2122738	71,79					6	16	30	70
RBF 1225/8	2122732	61,38							8	12	25	65

Fresa de metal duro forma árbol RBF. Dentado ALLROUND



Fresa forma árbol según DIN 8032.

Ref.	Código	Tipo	Ø Mango mm	Ø de cabeza mm	L2	L1	€/ u.
20035921	RBF 0618 ALLROUND M6	RBF 0618/6	6	6	18	55	26,48
20035922	RBF 0820 ALLROUND M6	RBF 0820/6	6	8	20	60	36,89
20035923	RBF 1020 ALLROUND M6	RBF 1020/6	6	10	20	60	44,94
20035924	RBF 1225 ALLROUND M6	RBF 1225/6	6	12	25	65	48,50
20035925	RBF 1630 ALLROUND M6	RBF 1630/6	6	16	30	70	68,86



Fresa de metal duro esférica KUD



Tipo	Dentado 1	€/u.	Dentado 3	€/u.	Dentado 3 plus	€/u.	Dentado 4	€/u.	Dentado 5	€/u.	Ø Mango mm	Ø de cabeza mm	L2	L1
KUD 0302/3					2321219	14,20	2321232	16,87	2321240	14,82	3	3	2	33
KUD 0403/3					2321220	17,82	2321233	20,54	2321241	17,87	3	4	3	34
KUD 0605/3					2321221	17,88	2321234	20,47	2321242	17,97	3	6	5	35
KUD 0403/6					2321222	22,92			2321243	23,02	6	4	3	45
KUD 0605/6	2321210	22,82			2321223	23,54	2321235	24,92	2321244	24,25	6	6	5	45
KUD 0807/6	2321211	23,80	2321215	26,42	2321224	23,80	2321236	27,46	2321245	26,78	6	8	7	47
KUD 1009/6	2321212	27,79	2321216	32,06	2321225	27,10	2321237	33,06	2321246	29,68	6	10	9	49
KUD 1210/6			2321217	38,72	2321226	33,75	2321238	38,51	2321247	38,70	6	12	10	50
KUD 1614/6	2321213	50,38			2321228	44,78	2321239	57,86	2321248	52,25	6	16	14	54
KUD 2018/6			2321218	68,79	2321230	63,77					6	20	18	58
KUD 1210/8					2321227	37,65					8	12	10	50
KUD 1614/8					2321229	48,45					8	16	14	54
KUD 2018/8					2321231	67,84					8	20	18	58

Tipo	Dentado Alu	€/u.	Dentado Alu plus	€/u.	Dentado Acero	€/u.	Dentado Inox	€/u.	Ø Mango mm	Ø de cabeza mm	L2	L1
KUD 0302/3							2321259	19,25	3	3	2	33
KUD 0605/3							2321260	23,54	3	6	5	35
KUD 0605/6					2321254	24,54	2321261	25,24	6	6	5	45
KUD 0807/6			2321252	28,99	2321255	25,17	2321262	26,14	6	8	7	47
KUD 1009/6					2321256	29,81	2321263	30,34	6	10	9	49
KUD 1210/6			2321253	41,14	2321257	35,71	2321264	37,09	6	12	10	50
KUD 1614/6					2321258	47,38			6	16	14	54
KUD 1614/8	2321251	56,25							8	16	14	54

Fresa de metal duro esférica KUD. Dentado ALLROUND



Fresa esférica según DIN 8032.

Ref.	Código	Tipo	Ø Mango mm	Ø de cabeza mm	L2	L1	€/u.
20035898	KUD 0605 ALLROUND M6	KUD 0605/6	6	6	5	45	23,73
20035899	KUD 0807 ALLROUND M6	KUD 0807/6	6	8	7	47	24,29
20035900	KUD 1009 ALLROUND M6	KUD 1009/6	6	10	9	49	27,67
20035901	KUD 1210 ALLROUND M6	KUD 1210/6	6	12	10	51	34,45
20035902	KUD 1614 ALLROUND M6	KUD 1614/6	6	16	14	54	45,72



Fresa de metal duro cónica redonda KEL



Ref.	Código	€/u.	Tipo	Ø Mango mm	Ø de cabeza mm	L2	L1
2123163	KEL 1020 D3 M6	43,45	KEL 1020/6	6	10	20	60
2123164	KEL 1225 D3 M6	58,14	KEL 1225/6	6	12	25	65

Fresa de metal duro con microdentado MZ



Ref.	Código	Longitud cabeza mm	Longitud mm	Ø de cabeza mm	Ø Mango mm	Tipo	€ / u.
2122894	ZYA 0210 MICRO M3	10	40	2	3	ZYA 0210/3 MICRO	23,38
2122895	ZYA 0413 MICRO M3	13	43	4	3	ZYA 0413/3 MICRO	24,67
2122896	ZYA 0616 MICRO M6	16	55	6	6	ZYA 0616/6 MICRO	29,79
2122897	ZYA 0820 MICRO M6	20	60	8	6	ZYA 0820/6 MICRO	42,14
2122898	ZYA 1020 MICRO M6	20	60	10	6	ZYA 1020/6 MICRO	46,88



Fresa de metal duro cónica redonda KEL



Tipo	Dentado 3 plus	€ / u.	Dentado 4	€ / u.	Dentado 5	€ / u.	Ø Mango mm	Ø de cabeza mm	L2	L1
KEL 1020/6	2123166	37,70	2123172	45,58			6	10	20	60
KEL 1225/6	2123167	50,37	2123173	57,39			6	12	25	65
KEL 1230/6	2123169	62,24	2123174	66,62	2123176	56,78	6	12	30	70
KEL 1630/6	2123171	70,80	2123175	77,74			6	16	30	70
KEL 1225/8	2123168	56,29					8	12	25	65
KEL 1230/8	2123170	63,42					8	12	30	70

Tipo	Dentado Alu	€ / u.	Dentado Alu plus	€ / u.	Dentado Acero	€ / u.	Dentado Inox	€ / u.	Dentado Cast	€ / u.	Ø Mango mm	Ø de cabeza mm	L2	L1
KEL 0820/6							2123186	45,20			6	8	20	60
KEL 1020/6						2123183	41,47	2123187	43,56		6	10	20	60
KEL 1230/6			2123181	72,46	2123184	67,16	2123188	68,13	2123189	66,79	6	12	30	70
KEL 1630/6	2123179	84,62			2123185	74,92					6	16	30	70
KEL 1630/8			2123182	81,79							8	16	30	70

Fresa de metal duro cónica redonda KEL. Dentado ALLROUND



Fresa de forma cónica redonda con cabeza redonda según DIN 8032.

Ref.	Código	Tipo	Ø Mango mm	Ø de cabeza mm	L2	L1	€ / u.
20035917	KEL 0820 ALLROUND M6	KEL 0820/6	6	8	20	60	37,99
20035918	KEL 1020 ALLROUND M6	KEL 1020/6	6	10	20	60	40,57
20035919	KEL 1225 ALLROUND M6	KEL 1225/6	6	12	25	70	58,35
20035920	KEL 1630 ALLROUND M6	KEL 1630/6	6	16	30	70	71,86
2122666	ZYA 1625 D3 M6	ZYA 1625/6	6	16	25	65	61,39



Juego de fresas pequeñas de metal duro



Juego de fresas pequeñas de metal duro de 3 piezas, dentado 3 PLUS, mango Ø 3 mm, medio universal, dentado cruzado. En caja de plástico rígido que protege de la suciedad y de roturas.



Ref.	Código	Composición	€ / u.
2400703	1504 Z3 PLUS	1 fresa de metal duro de cada (Ø mango 3 mm, dentado universal 3 PLUS): Cilíndrica dentado frontal ZYAS 0313/3, cilíndrica redondeada WRC 0313/3, forma árbol RBF 0313/3	40,49
2400704	1507 Z3 PLUS 3TLG	1 fresa de metal duro de cada (Ø mango 6 mm, dentado universal 3 PLUS): Cilíndrica dentado frontal ZYAS 1225/6, cilíndrica redondeada WRC 1225/6, forma árbol RBF 1225/6	138,81
2400705	1505 Z3 PLUS 3TLG	1 fresa de metal duro de cada (Ø mango 6 mm, dentado universal 3 PLUS): Cilíndrica dentado frontal ZYAS 0616/6, cilíndrica redondeada WRC 0616/6, forma árbol RBF 0618/6	69,22
2400706	1414 ALLROUND HC-FEP	1 fresa de metal duro de cada (Ø mango 6 mm, dentado universal ALLROUND con recubrimiento HC-FEP): Cilíndrica dentado frontal ZYAS 1225/6, cilíndrica redondeada WRC 1225/6, forma árbol RBF 1225/6	204,40
2400707	1906 INOX 3TLG	1 fresa de metal duro de cada (Ø mango 6 mm, dentado INOX): Cilíndrica dentado frontal ZYAS 0616/6, cilíndrica redondeada WRC 0616/6, forma árbol RBF 0618/6	83,09
2400708	1907 INOX 3TLG	1 fresa de metal duro de cada (Ø mango 6 mm, dentado INOX): Cilíndrica dentado frontal ZYAS 1225/6, cilíndrica redondeada WRC 1225/6, forma árbol RBF 1225/6	166,52
2400709	1806 STEEL 3TLG	1 fresa de metal duro de cada (Ø mango 6 mm, dentado STEEL): Cilíndrica dentado frontal ZYAS 0616/6, cilíndrica redondeada WRC 0616/6, forma árbol RBF 0618/6	76,14
2400710	1807 STEEL 3TLG	1 fresa de metal duro de cada (Ø mango 6 mm, dentado STEEL): Cilíndrica dentado frontal ZYAS 1225/6, cilíndrica redondeada WRC 1225/6, forma árbol RBF 1225/6	152,68
2400711	1303 MICRO	1 fresa de metal duro de cada (Ø mango 3 mm, dentado para afinado MICRO): Cilíndrica ZYA 0313/3, cilíndrica redondeada WRC 0313/3, forma árbol RBF 0313/3	77,01
2400712	1306 MICRO	1 fresa de metal duro de cada (Ø mango 6 mm, dentado para afinado MICRO): Cilíndrica dentado frontal ZYAS 0616/6, cilíndrica redondeada WRC 0616/6, forma árbol RBF 0618/6	97,05
2400713	1312 MICRO	1 fresa de metal duro de cada (Ø mango 6 mm, dentado para afinado MICRO): Cilíndrica dentado frontal ZYAS 1225/6, cilíndrica redondeada WRC 1225/6, forma árbol RBF 1225/6	194,53
2400714	1403 ALLROUND	1 fresa de metal duro de cada (Ø mango 3 mm, dentado universal ALLROUND): Cilíndrica dentado frontal ZYAS 0313/3, cilíndrica redondeada WRC 0313/3, forma árbol RBF 0313/3	43,83
2400715	1404 ALLROUND	1 fresa de metal duro de cada (Ø mango 3 mm, dentado universal ALLROUND): Cilíndrica dentado frontal ZYAS 0613/3, cilíndrica redondeada WRC 0613/3, forma árbol RBF 0613/3	51,35
2400716	1406 ALLROUND	1 fresa de metal duro de cada (Ø mango 6 mm, dentado universal ALLROUND): Cilíndrica dentado frontal ZYAS 0616/6, cilíndrica redondeada WRC 0616/6, forma árbol RBF 0618/6	78,38
2400717	1414 ALLROUND	1 fresa de metal duro de cada (Ø mango 6 mm, dentado universal ALLROUND): Cilíndrica dentado frontal ZYAS 1225/6, cilíndrica redondeada WRC 1225/6, forma árbol RBF 1225/6	157,09

03

4412 Fresa frontal mango cilíndrico IZ acabado HSS aluminio



HSS	IZAR Std. W	Serie Corta Short Length Série Courte		d= 8-10 mm	Tol.* D (k10) d (h6)	*øD=ød => Tol. D (js14) d (h6)
-----	-------------	---------------------------------------	--	------------	----------------------	--------------------------------

Ref. HSS	Código HSS	D mm	l mm	l mm	d mm	€ / u.
121800	44087	3	12	60	8	12,36
121801	44090	4	12	60	8	12,36
121802	44093	5	12	60	8	12,36
121803	44096	6	14	60	8	12,36

Ref. HSS	Código HSS	D mm	l mm	l mm	d mm	€ / u.
121804	44099	7	14	60	8	15,10
121805	44102	8	15	80	8	15,10
121806	44105	10	15	80	10	15,53



4410 Fresa frontal mango cilíndrico IZ acabado HSSE 5% Co aluminio

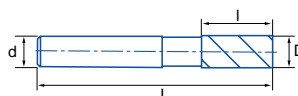

HSSE 5% Co	IZAR Std. W		Tol.* D (k10) d (h6)	* $\varnothing D = \varnothing d \Rightarrow$ Tol. D (js14) d (h6)
---------------	-------------------	--	----------------------------	--

Ref. HSSE	Código HSSE	D mm	l mm	l mm	d mm	€ / u.	Ref. HSSE	Código HSSE	D mm	l mm	l mm	d mm	€ / u.
121900	13932	3	12	60	8	16,85	121904	13937	7	14	60	8	20,57
121901	13933	4	12	60	8	16,85	121905	13938	8	15	80	8	20,57
121902	13935	5	12	60	8	16,85	121906	13939	10	15	80	10	21,17
121903	13936	6	14	60	8	16,85							

4413 Fresa frontal mango cilíndrico IZ acabado HSS aluminio



HSS	IZAR Std. W	Serie Corta Short Length Série Courte		d= 6 mm	Tol.* D (k10) d (h6)	* $\varnothing D = \varnothing d \Rightarrow$ Tol. D (js14) d (h6)
-----	-------------------	---	--	------------	----------------------------	--

Ref. HSS	Código HSS	D mm	l mm	l mm	d mm	€ / u.	Ref. HSS	Código HSS	D mm	l mm	l mm	d mm	€ / u.
122000	44108	3	12	60	6	12,36	122002	44114	5	12	60	6	12,36
122001	44111	4	12	60	6	12,36	122003	44117	6	14	60	6	12,36

4411 Fresa frontal mango cilíndrico IZ acabado HSSE 5% Co aluminio



HSSE 5% Co	IZAR Std. W			Tol.* D (k10) d (h6)	* $\varnothing D = \varnothing d \Rightarrow$ Tol. D (js14) d (h6)
---------------	-------------------	--	--	----------------------------	--

Ref. HSSE	Código HSSE	D mm	l mm	l mm	Y mm	d mm	€ / u.	Ref. HSSE	Código HSSE	D mm	l mm	l mm	Y mm	d mm	€ / u.
122100	13941	4	16	80	29	8	23,80	122102	13944	6	16	90	29	8	23,80
122101	13943	5	16	80	29	8	23,80	122103	13945	8	28	100	40	8	26,42

4414 Fresa frontal mango cilíndrico IZ acabado HSS aluminio



HSS	IZAR Std. W	Serie Larga Long Length Série Longue	4414 d= 8 mm			Tol.* D (k10) d (h6)	* $\varnothing D = \varnothing d \Rightarrow$ Tol. D (js14) d (h6)
-----	-------------------	--	--------------------	--	--	----------------------------	--

Ref. HSS	Código HSS	D mm	l mm	l mm	Y mm	d mm	€ / u.	Ref. HSS	Código HSS	D mm	l mm	l mm	Y mm	d mm	€ / u.
122200	44120	4	16	80	29	8	17,47	122203	44129	8	28	100	40	8	19,39
122201	44123	5	16	80	29	8	17,47	122204	29178	10	40	120	40	10	19,98
122202	44126	6	16	90	29	8	17,47								



6420 Juego de fresas frontales mango cilíndrico 2Z acabado



Ref.	Código	Nº Piezas	Contenido	Material	€/ u.
214914	14914	10	Ø 4 - 5 - 6 - 8 - 10 - 12 - 14 - 16 - 18 - 20 mm	PMX	292,92
214916	14916	10	Ø 4 - 5 - 6 - 8 - 10 - 12 - 14 - 16 - 18 - 20 mm	TIALN-TOP	381,45



14914



14916

6420 Fresa frontal mango cilíndrico 2Z acabado PMX



03



IZARMAX

PMX

PMX + TIALN-TOP

DIN 327 N

30°

Tol. D (e8) d (h6)

Ref. PMX	Código PMX	€/ u. PMX	Ref. TIALN-TOP	Código TIALN-TOP	€/ u. TIALN-TOP	D mm	d mm	L mm	l mm
245250	45250	14,74	245400	45400	21,22	4	6	51	7
245251	45251	14,74	245401	45401	21,22	5	6	52	8
245252	45252	14,74	245402	45402	21,22	6	6	52	8
245253	45253	22,23	245403	45403	29,38	7	10	60	10
245254	45254	19,22	245404	45404	26,55	8	10	61	11
223135	23135	23,80	223144	23144	31,63	9	10	61	11
245255	45255	21,41	245405	45405	29,37	10	10	63	13
245256	45256	27,24	245406	45406	38,03	12	12	73	16
245257	45257	37,34	245408	45408	46,93	14	12	73	16
245258	45258	43,28	245409	45409	55,54	16	16	79	19
245259	45259	53,24	245410	45410	65,68	18	16	79	19
245260	45260	62,39	245411	45411	75,77	20	20	88	22
211119	11119	106,67	213147	13147	133,13	25	25	102	26
211120	11120	134,96	213156	13156	173,30	28	25	102	26

4421 Fresa frontal mango cilíndrico 2Z acabado HSS



HSS

DIN 327 N

ISO 1641/1

30°

Tol. D (e8) d (h6)

Ref. HSS	Código HSS	D mm	d mm	L mm	l mm	€/ u.	Ref. HSS	Código HSS	D mm	d mm	L mm	l mm	€/ u.
122800	44162	2,00	6	48	4	9,11	122818	44198	12,00	12	73	16	15,24
122801	44165	2,50	6	49	5	9,11	122819	44201	13,00	12	73	16	22,76
122802	44168	3,00	6	49	5	9,11	122820	44204	14,00	12	73	16	21,50
122803	44171	3,50	6	50	6	9,51	122821	44207	15,00	12	73	16	24,56
122804	44174	4,00	6	51	7	9,11	122822	44210	16,00	16	79	19	22,46
122805	73802	4,50	6	52	8	10,25	122823	44213	17,00	16	79	19	29,50
122806	44177	5,00	6	52	8	9,11	122824	44216	18,00	16	79	19	29,50
122807	73805	5,50	6	52	8	11,18	122825	44219	19,00	16	79	19	36,26
122808	44180	6,00	6	52	8	9,11	122826	44222	20,00	20	88	22	34,58
122809	73808	6,50	10	60	10	14,33	122827	44225	22,00	20	88	22	47,54
122810	44183	7,00	10	60	10	13,52	122828	44228	24,00	25	102	26	59,58
122811	73811	7,50	10	61	11	14,07	122829	44231	25,00	25	102	26	59,58
122812	44186	8,00	10	61	11	11,08	122830	44234	28,00	25	102	26	74,49
122813	73814	8,50	10	61	11	15,79	122831	44237	30,00	25	102	26	86,21
122814	44189	9,00	10	61	11	14,15	122832	44240	32,00	32	112	32	88,79
122815	73817	9,50	10	61	11	15,48	122833	44243	36,00	32	112	32	116,25
122816	44192	10,00	10	63	13	11,62	122834	44246	40,00	40	130	38	139,72
122817	44195	11,00	12	70	13	17,70							



4426 Fresa frontal mango cilíndrico 2Z acabado HSSE 8% Co



HSSE 8% Co	HSSE 8% Co + TIALSIN	IZAR Std. N	ISO 1641					Tol. D (e8) d (h6)	
---------------	----------------------------	----------------	-------------	--	--	--	--	--------------------------	--

Ref. HSSE	Código HSSE	€/ u. HSSE	Ref. TIALSIN	Código TIALSIN	€/ u. TIALSIN	d mm	D mm	L mm	l mm
123900	44357	12,52	124000	16074	19,67	2,00	6	54	7
123901	44360	12,52	124001	16092	19,67	2,50	6	56	8
123902	44363	12,52	124002	45029	19,67	3,00	6	56	8
123903	44366	12,52	124003	45030	19,67	4,00	6	63	11
123904	44369	12,52	124004	45031	19,67	5,00	6	68	13
123905	44372	12,52	124005	45032	19,67	6,00	6	68	13
123906	44375	20,80	124006	17192	28,83	7,00	10	80	16
123907	44378	18,19	124007	45034	26,33	8,00	10	88	19
123908	44381	24,63	124008	15849	33,36	9,00	10	88	19
123909	44384	20,80	124009	14538	30,59	10,00	10	95	22
123910	44387	31,84	124010	17193	42,66	11,00	12	102	22
123911	44390	29,52	124011	14550	40,37	12,00	12	110	26
123912	44393	38,39	124012	17194	49,34	14,00	12	110	26
123913	44396	45,17	124013	17195	60,80	16,00	16	123	32
123914	44399	53,86	124014	14562	71,31	18,00	16	123	32
123915	44402	59,10	124015	17197	78,26	20,00	20	141	38
123916	44405	79,78	124016	17198	106,19	22,00	20	141	38
123917	44408	114,45	124017	17199	142,90	25,00	25	166	45
123918	44411	137,36	124018	17200	173,83	28,00	25	166	45
123919	81024	151,81	124019	17201	187,89	30,00	25	166	45
123920	44414	211,24	124020	17202	245,69	32,00	32	186	53

6430 Fresa frontal mango cilíndrico 3Z acabado PMX

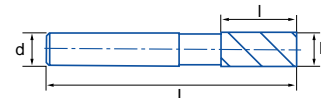

IZARMAX

PMX	PMX + TIALN-TOP	DIN 844 W					Tol. D (e8) d (h6)	
-----	-----------------------	--------------	--	--	--	--	--------------------------	--

Ref. PMX	Código PMX	€/ u. PMX	Ref. TIALN-TOP	Código TIALN-TOP	€/ u. TIALN-TOP	D mm	d mm	L mm	l mm
125900	45277	17,76	126000	45415	24,18	4	4	55	11
125901	45279	17,76	126001	45417	24,18	5	5	57	13
125902	45280	17,76	126002	45420	24,18	6	6	57	13
125903	45312	23,81	126003	45423	30,50	7	7	66	16
125904	45333	23,81	126004	45426	30,50	8	8	69	19
125905	45336	25,28	126005	45429	32,61	10	10	72	22
125906	45339	32,39	126006	45432	40,40	12	12	83	26
125907	45340	43,83	126007	45438	52,80	14	14	83	26
125908	45342	50,63	126008	45441	61,61	16	16	92	32
125909	45343	61,75	126009	45444	73,59	18	18	92	32
125910	45344	72,59	126010	45447	85,58	20	20	104	38
125911	11124	123,53	126011	13159	152,71	25	25	121	45
125912	11126	147,69	126012	13177	185,60	28	25	121	45



6600 Fresa frontal mango cilíndrico NZ acabado PMX

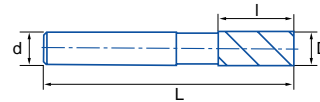

IZARMAX

PMX
PMX + TIALN-TOP
DIN 844 N
4-6 Z
Tol. D (k10) d (h6)

Ref. PMX	Código PMX	€/u. PMX	Ref. TIALN-TOP	Código TIALN-TOP	€/u. TIALN-TOP	D mm	d mm	L mm	l mm	Z	Ref. PMX	Código PMX	€/u. PMX	Ref. TIALN-TOP	Código TIALN-TOP	€/u. TIALN-TOP	D mm	d mm	L mm	l mm	Z
127300	45718	16,06	127400	45932	22,21	2	6	51	7	4	127308	45183	29,44	127408	45523	38,11	12	12	83	26	4
127301	45166	16,06	127401	45481	22,21	3	6	52	8	4	127309	45186	39,85	127409	45525	48,81	14	12	83	26	4
127302	45168	16,06	127402	45482	22,21	4	6	55	11	4	127310	45189	46,01	127410	45526	56,55	16	16	92	32	4
127303	45169	16,06	127403	45483	22,21	5	6	57	13	4	127311	45192	56,16	127411	45528	67,99	18	16	92	32	4
127304	45171	16,06	127404	45933	22,21	6	6	57	13	4	127312	45195	66,00	127412	45531	78,98	20	20	104	38	4
127305	45174	21,64	127405	45496	29,34	7	10	66	16	4	127313	45198	112,29	127413	45534	130,14	25	25	121	45	6
127306	45177	21,50	127406	45510	28,38	8	10	69	19	4	127314	11135	134,29	127414	13221	174,81	28	25	121	45	6
127316	23134	25,66	127416	23147	32,97	9	10	69	19	4	127317	14826	156,85	127417	14895	182,21	30	25	121	45	6
127307	45180	22,90	127407	45522	30,35	10	10	72	22	4	127315	45720	165,07	127415	45222	190,42	32	32	133	53	6

6666 Fresa frontal mango cilíndrico NZ PMX hélice alterna TIALN-TOP

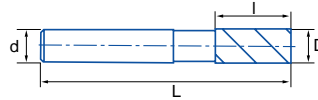

HV

PMX
TIALN-TOP
DIN 844 N
4-6 Z
Tol. D (k10) d (h6)
0,20x45°

Ref. TIALN-TOP	Código TIALN-TOP	D mm	d mm	L mm	l mm	Z	€/u. TIALN-TOP
147100	28488	6	6	57	13	4	27,55
147101	28489	8	10	69	19	4	35,56
147102	28478	10	10	72	22	4	38,00
147103	28479	12	12	83	26	4	47,97
147104	28492	16	16	92	32	5	71,98
147105	28494	18	16	92	32	5	86,79
147106	28495	20	20	104	38	5	101,09
147107	28484	25	25	121	45	6	167,83



03

4400 Fresa frontal mango cilíndrico NZ acabado HSSE 8% Co



HSSE 8% Co	HSSE 8% Co + TIALSIN	DIN 844 N	ISO 1641					Tol. D (k10) d (h6)	
------------	----------------------	-----------	----------	--	--	--	--	---------------------	--

Ref. HSSE	Código HSSE	€/u. HSSE	Ref. TIALSIN	Código TIALSIN	€/u. TIALSIN	D mm	d mm	L mm	l mm
127800	43778	12,44	127900	17528	19,60	2	6	51	7
127801	43781	12,44	127901	17529	19,60	2,5	6	52	8
127802	43784	12,44	127902	17530	19,60	3	6	52	8
127803	43787	12,84	127903	17531	19,98	3,5	6	54	10
127804	43790	12,44	127904	17533	19,60	4	6	55	11
127805	43793	13,70	127905	17590	20,86	4,5	6	55	11
127806	43796	12,44	127906	17536	19,60	5	6	57	13
127807	43799	19,94	127907	17537	26,87	5,5	6	57	13
127808	43802	13,06	127908	43903	20,21	6	6	57	13
127809	43805	19,94	127909	17538	28,02	6,5	10	66	16
127810	43808	18,26	127910	17539	26,37	7	10	66	16
127811	43811	23,54	127911	17540	31,53	7,5	10	66	16
127812	43814	16,30	127912	43904	24,50	8	10	69	19
127813	43817	24,57	127913	17542	33,31	8,5	10	69	19
127814	43820	20,41	127914	17543	29,26	9	10	69	19

Ref. HSSE	Código HSSE	€/u. HSSE	Ref. TIALSIN	Código TIALSIN	€/u. TIALSIN	D mm	d mm	L mm	l mm
127815	43823	25,99	127915	17544	34,68	9,5	10	69	19
127816	43826	17,67	127916	43905	26,60	10	10	72	22
127817	43829	24,62	127917	17545	34,57	11	12	79	22
127818	43832	22,19	127918	43906	30,68	12	12	83	26
127819	43835	31,68	127919	17546	42,80	13	12	83	26
127820	43838	30,47	127920	43907	41,62	14	12	83	26
127821	43841	34,12	127921	17548	47,27	15	12	83	26
127822	43844	33,32	127922	43908	46,45	16	16	92	32
127823	43847	41,00	127923	17549	55,66	17	16	92	32
127824	43850	41,80	127924	43909	56,44	18	16	92	32
127825	43853	48,02	127925	17551	64,04	19	16	92	32
127826	43856	48,02	127926	43910	64,04	20	20	104	38
127827	43859	66,68	127927	17552	88,64	22	20	104	38
127828	43862	82,83	127928	17553	104,35	24	25	121	42
127829	43865	82,83	127929	17554	104,35	25	25	121	42

4640 Fresa frontal mango cilíndrico NZ desbaste grueso HSSE 8% Co



HSSE 8% Co	HSSE 8% Co + TIALSIN	DIN 844 NR	ISO 1641							Tol. D (k12) d (h6)	
------------	----------------------	------------	----------	--	--	--	--	--	--	---------------------	--

Ref. HSSE	Código HSSE	D mm	d mm	L mm	l mm	€/u.
129400	46457	6	6	57	13	31,87
129401	77662	7	7	66	16	38,39
129402	46460	8	8	69	19	33,28
129403	77663	9	9	69	19	39,86
129404	46463	10	10	72	22	33,32
129405	77664	11	11	79	22	48,74
129406	46466	12	12	83	26	39,87
129407	77665	13	13	83	26	56,62
129408	46469	14	14	83	26	46,63
129409	77666	15	15	83	26	61,32
129410	46472	16	16	92	32	54,95
129411	77667	17	17	92	32	75,55

Ref. HSSE	Código HSSE	D mm	d mm	L mm	l mm	€/u.
129412	46475	18	18	92	32	60,33
129413	77668	19	19	92	32	88,65
129414	46478	20	20	104	38	75,58
129415	46481	22	22	104	38	89,48
129416	77669	24	24	121	45	112,53
129417	46484	25	25	121	45	111,73
129418	77670	26	26	121	45	117,89
129419	46487	28	28	121	45	117,48
129420	46490	30	30	121	45	130,46
129421	46493	32	32	133	53	143,08
129422	77671	36	36	133	53	169,41
129423	77672	40	40	155	63	190,48

6644 Fresa frontal mango cilíndrico NZ desbaste fino PMX



IZARMAX

PMX	PMX + TIALN-TOP	DIN 844 NR-F		4-6 Z				Tol. D (k12) d (h6)	
-----	-----------------	--------------	--	-------	--	--	--	---------------------	--

Ref. PMX	Código PMX	€/ u. PMX	Ref. TIALN-TOP	Código TIALN-TOP	€/ u. TIALN-TOP	D mm	d mm	L mm	l mm	Z
130200	45201	39,72	130300	45529	46,16	6	6	57	13	4
130201	45204	43,31	130301	45532	50,45	8	10	69	19	4
130202	45207	40,99	130302	45535	49,07	10	10	72	22	5
130203	45209	54,17	130303	45537	63,03	12	12	83	26	5
130204	45210	65,34	130304	45538	75,08	14	12	83	26	5
130205	45211	80,87	130305	45540	92,15	16	16	92	32	5

Ref. PMX	Código PMX	€/ u. PMX	Ref. TIALN-TOP	Código TIALN-TOP	€/ u. TIALN-TOP	D mm	d mm	L mm	l mm	Z
130206	45213	88,01	130306	45543	100,78	18	16	92	32	5
130207	45216	111,23	130307	45546	124,85	20	20	104	38	5
130208	45219	164,73	130308	45549	182,87	25	25	121	45	5
130209	13223	180,75	130309	12822	204,23	28	25	121	45	5
130210	14817	219,30	130310	14883	247,02	30	25	121	45	5
130211	45717	240,51	130311	45248	265,81	32	32	133	53	6

03

6430 Juego de fresas frontales mango cilíndrico 3Z acabado



Ref.	Código	Nº Piezas	Material	Contenido	€/ u.
132600	14919	10	PMX	Ø 4 - 5 - 6 - 8 - 10 - 12 - 14 -	345,38
132601	14922	10	TIALN-TOP	16 - 18 - 20 mm	427,15



6600 Juego de fresas frontales mango cilíndrico NZ acabado



Ref.	Código	Nº Piezas	Material	Contenido	€/ u.
133000	14911	10	PMX	Ø 4 - 5 - 6 - 8 - 10 - 12 - 14 -	313,54
133001	14913		TIALN-TOP	16 - 18 - 20 mm	395,01
8000214	14294	6	PMX	Ø 4 - 5 - 6 - 8 - 10 - 12 mm	115,92
8000215	14295		TIALN-TOP		155,30



6644 Juego de fresas frontales mango cilíndrico NZ desbaste fino



Ref.	Código	Nº Piezas	Material	Contenido	€/ u.
133100	14904	8	PMX	Ø 6 - 8 - 10 - 12 - 14 - 16 - 18	497,46
133101	14907		TIALN-TOP	- 20 mm	571,49
8000216	14241	4	PMX	Ø 6 - 8 - 10 - 12 mm	169,28
8000217	14275		TIALN-TOP		198,27





Fresa hueca

R.P.M. Y AVANCES RECOMENDADOS PARA FRESAS M42

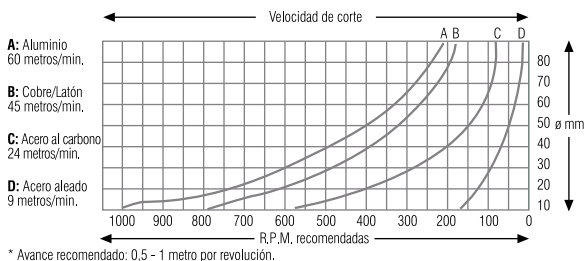

CORTAS	LARGAS	EXTRA LARGAS
profundidad 30 mm	profundidad 55 mm	profundidad 110 mm

CORTAS	LARGAS	EXTRA LARGAS
profundidad 30 mm	profundidad 55 mm	profundidad 110 mm

Ref.	Código	€/u.	Ref.	Código	€/u.	Ref.	Código	€/u.	Ø mm	profundidad (mm)
			139300	HCL120	37,58				12	30
139201	HCS130	25,16	139301	HCL130	37,58				13	30
139202	HCS140	25,16	139302	HCL140	37,58				14	30
139203	HCS150	25,16	139303	HCL150	37,58				15	30
139204	HCS160	26,78	139304	HCL160	37,58				16	30
139205	HCS170	28,39	139305	HCL170	39,15				17	30
139206	HCS180	28,39	139306	HCL180	40,73				18	30
139207	HCS190	29,14	139307	HCL190	41,55				19	30
139208	HCS200	29,96	139308	HCL200	43,16	139408	HXC200	141,00	20	30
139209	HCS210	31,54	139309	HCL210	46,35	139409	HXC210	159,79	21	30
139210	HCS220	32,36	139310	HCL220	48,75	139410	HXC220	169,20	22	30
139211	HCS230	33,98	139311	HCL230	49,58	139411	HXC230	178,61	23	30
139212	HCS240	36,75	139312	HCL240	51,94	139412	HXC240	186,11	24	30
139213	HCS250	37,58	139313	HCL250	54,34	139413	HXC250	193,65	25	30
139214	HCS260	39,15	139314	HCL260	55,91	139414	HXC260	203,03	26	30
139215	HCS270	39,94	139315	HCL270	59,10	139415	HXC270	212,44	27	30
139216	HCS280	41,55	139316	HCL280	61,58	139416	HXC280	219,94	28	30
139217	HCS290	42,34	139317	HCL290	63,94	139417	HXC290	229,35	29	30
139218	HCS300	46,35	139318	HCL300	67,91	139418	HXC300	236,89	30	30
139219	HCS310	52,73	139319	HCL310	70,31	139419	HXC310	246,26	31	30

Ref.	Código	€/u.	Ref.	Código	€/u.	Ref.	Código	€/u.	Ø mm	profundidad (mm)
139220	HCS320	55,91	139320	HCL320	73,50	139420	HXC320	253,80	32	30
139221	HCS330	59,10	139321	HCL330	76,69	139421	HXC330	263,18	33	30
139222	HCS340	63,94	139322	HCL340	81,53	139422	HXC340	270,71	34	30
139223	HCS350	70,31	139323	HCL350	84,68	139423	HXC350	276,34	35	30
139224	HCS360	75,11	139324	HCL360	87,90	139424	HXC360	287,63	36	30
139225	HCS370	76,69	139325	HCL370	91,09	139425	HXC370	295,16	37	30
139226	HCS380	78,30	139326	HCL380	95,85	139426	HXC380	302,70	38	30
139227	HCS390	81,53	139327	HCL390	100,69	139427	HXC390	312,08	39	30
139228	HCS400	83,10	139328	HCL400	105,49	139428	HXC400	319,58	40	30
139229	HCS410	86,33	139329	HCL410	110,25	139429	HXC410	329,03	41	30
139230	HCS420	91,09	139330	HCL420	113,48	139430	HXC420	338,40	42	30
139231	HCS430	92,74	139331	HCL430	121,46	139431	HXC430	344,03	43	30
139232	HCS440	100,69	139332	HCL440	132,68	139432	HXC440	349,65	44	30
139233	HCS450	102,26	139333	HCL450	139,01	139433	HXC450	353,44	45	30
139234	HCS460	105,49	139334	HCL460	147,04	139434	HXC460	360,98	46	30
139235	HCS470	108,68	139335	HCL470	158,21	139435	HXC470	368,48	47	30
139236	HCS480	113,48	139336	HCL480	166,20	139436	HXC480	376,01	48	30
139237	HCS490	119,85	139337	HCL490	171,00	139437	HXC490	381,64	49	30
139238	HCS500	121,46	139338	HCL500	175,80	139438	HXC500	389,18	50	30

8500 - CCMT C - 525

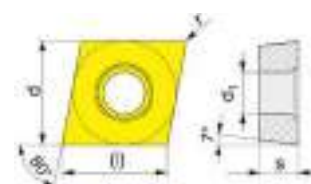

Acabado fino

Ref.	Código	d mm	d1 mm	l mm	ISO	r mm	s mm	€/u.
142707	17842	9,525	4,4	9,7	CCMT-09T308-E-ZMM	0,8	3,97	8,50
142708	17845	12,700	5,5	12,9	CCMT-120408-E-ZMM	0,8	4,76	10,70
142711	42895	9,52	4,4	9,7	CCMT-09T304-E-ZMM	0,4	3,97	8,50
142712	42898	12,7	5,5	12,9	CCMT-120404-E-ZMM	0,4	4,76	10,70

Semi acabado

Ref.	Código	d mm	d1 mm	l mm	ISO	r mm	s mm	€/u.
142700	26277	6,350	2,8	6,4	CCMT-060202-E-ZRR	0,2	2,38	8,50
142701	26278	6,350	2,8	6,4	CCMT-060204-E-ZRR	0,4	2,38	8,50
142702	26280	9,525	4,4	9,7	CCMT-09T304-E-ZRR	0,4	3,97	8,50
142703	26281	9,525	4,4	9,7	CCMT-09T308-E-ZRR	0,8	3,97	8,50
142704	10131	12,700	5,5	12,9	CCMT-120408-E-ZRR	0,8	4,76	10,70
142710	42901	12,7	5,5	12,9	CCMT-120404-E-ZRR	0,4	4,76	10,70



8500 - CCMT P - 625.



Acabado

Ref.	Código	d mm	d1 mm	l mm	ISO	r mm	s mm	€/ u.
142850	19983	6,350	2,8	6,4	CCMT-060204-ZFCE	0,4	2,38	9,40
142851	19987	9,525	4,4	9,7	CCMT-09T304-ZFCE	0,4	3,97	12,25
142852	19989	9,525	4,4	9,7	CCMT-09T308-ZFCE	0,8	3,97	12,25
142811	42899	12,7	5,5	12,9	CCMT-120404-E-ZMM	0,4	4,76	10,70

Semi acabado

Ref.	Código	d mm	d1 mm	l mm	ISO	r mm	s mm	€/ u.
142800	10233	6,350	2,8	6,4	CCMT-060202-E-ZRR	0,2	2,38	8,50
142801	10242	6,350	2,8	6,4	CCMT-060204-E-ZRR	0,4	2,38	8,50
142802	10278	9,525	4,4	9,7	CCMT-09T304-E-ZRR	0,4	3,97	8,50
142803	10287	9,525	4,4	9,7	CCMT-09T308-E-ZRR	0,8	3,97	8,50

Acabado fino

Ref.	Código	d mm	d1 mm	l mm	ISO	r mm	s mm	€/ u.
142807	17844	9,525	4,4	9,7	CCMT-09T308-E-ZMM	0,8	3,97	8,50
142808	17856	12,700	5,5	12,9	CCMT-120408-E-ZMM	0,8	4,76	10,70
142810	42896	9,52	4,4	9,7	CCMT-09T304-E-ZMM	0,4	3,97	8,50

8510 - CNMG C - 515



Acabado

Ref.	Código	d mm	d1 mm	l mm	ISO	r mm	s mm	€/ u.
142920	17863	12,7	5,16	12,9	CNMG-120404-E-ZFM	0,4	4,76	9,61
142925	42902	12,7	5,16	12,9	CNMG-120408-E-ZFM	0,8	4,76	9,61

Semi desbaste

Ref.	Código	d mm	d1 mm	l mm	ISO	r mm	s mm	€/ u.
142921	17867	12,7	5,16	12,9	CNMG-120408-E-ZM	0,8	4,76	9,61
142922	17885	12,7	5,16	12,9	CNMG-120412-E-ZM	1,2	4,76	9,61

Desbaste

Ref.	Código	d mm	d1 mm	l mm	ISO	r mm	s mm	€/ u.
142923	17893	12,7	5,16	12,9	CNMG-120408-E-ZR	0,8	4,76	9,61
142924	17909	12,7	5,16	12,9	CNMG-120412-E-ZR	1,2	4,76	9,61
142926	42913	19,05	7,94	19,3	CNMG-190608-E-ZR	0,8	6,35	25,82
142927	42915	19,05	7,94	19,3	CNMG-190612-E-ZR	1,2	6,35	25,82



8510 - CNMG C - 525



Acabado

Ref.	Código	d mm	d1 mm	l mm	ISO	r mm	s mm	€/ u.
142915	59273	9,52	3,81	9,7	CNMG-090304-E-ZFM	0,4	3,18	8,13
142916	59274	9,52	3,81	9,7	CNMG-090308-E-ZFM	0,8	3,18	8,13
142900	26286	12,7	5,16	12,9	CNMG-120404-E-ZFM	0,4	4,76	9,61
142917	42903	12,7	5,16	12,9	CNMG-120408-E-ZFM	0,8	4,76	9,61

Semi desbaste

Ref.	Código	d mm	d1 mm	l mm	ISO	r mm	s mm	€/ u.
142901	26292	12,7	5,16	12,9	CNMG-120408-E-ZM	0,8	4,76	9,61
142902	26290	12,7	5,16	12,9	CNMG-120412-E-ZM	1,2	4,76	9,61

Desbaste

Ref.	Código	d mm	d1 mm	l mm	ISO	r mm	s mm	€/ u.
142903	26289	12,7	5,16	12,9	CNMG-120408-E-ZR	0,8	4,76	9,61
142904	26293	12,7	5,16	12,9	CNMG-120412-E-ZR	1,2	4,76	9,61
142918	42914	19,05	7,94	19,3	CNMG-190608-E-ZR	0,8	6,35	25,82
142919	42916	19,05	7,94	19,3	CNMG-190612-E-ZR	1,2	6,35	25,82

8510 - CNMG C - 540



Semi desbaste

Ref.	Código	d mm	d1 mm	l mm	ISO	r mm	s mm	€/ u.
142930	17873	12,7	5,16	12,9	CNMG-120408-E-ZM	0,8	4,76	9,61
142931	28592	12,7	5,16	12,9	CNMG-120412-E-ZM	1,2	4,76	9,61

Desbaste

Ref.	Código	d mm	d1 mm	l mm	ISO	r mm	s mm	€/ u.
142932	17902	12,7	5,16	12,9	CNMG-120408-E-ZR	0,8	4,76	9,61
142933	17911	12,7	5,16	12,9	CNMG-120412-E-ZR	1,2	4,76	9,61

8510 - CNMG CERMET



Acabado

Ref.	Código	d mm	d1 mm	l mm	ISO	r mm	s mm	€/ u.
142940	16630	12,7	5,16	12,9	CNMG-120404-E-ZFCE	0,4	4,76	15,49

Semi acabado

Ref.	Código	d mm	d1 mm	l mm	ISO	r mm	s mm	€/ u.
142941	19981	12,7	5,16	12,9	CNMG-120408-E-ZMCE	0,8	4,76	15,49

8510 - CNMG C - G15 Semi desbaste. Alto rendimiento

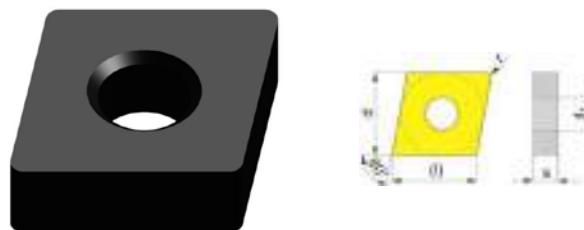

Ref.	Código	d mm	d1 mm	l mm	ISO	r mm	s mm	€/ u.
8000448	71279	12,7	5,16	12,9	CNMG-120404-ZPM	0,4	4,76	10,57
8000449	71281	12,7	5,16	12,9	CNMG-120408-ZPM	0,8	4,76	10,57
8000450	71283	12,7	5,16	12,9	CNMG-120412-ZPM	1,2	4,76	10,57

8510 - CNMG C - G25 Semi desbaste. Alto rendimiento



Ref.	Código	d mm	d1 mm	l mm	ISO	r mm	s mm	€/ u.
8000451	71280	12,7	5,16	12,9	CNMG-120404-ZPM	0,4	4,76	10,57
8000452	71282	12,7	5,16	12,9	CNMG-120408-ZPM	0,8	4,76	10,57
8000453	71284	12,7	5,16	12,9	CNMG-120412-ZPM	1,2	4,76	10,57

8510 - CNMG P - 720. INOX



Ref.	Código	d mm	d1 mm	l mm	ISO	r mm	s mm	€/ u.
142928	35197	12,7	5,16	12,9	CNMG-120404-E-ZNM	0,4	4,76	9,61
142929	35198	12,7	5,16	12,9	CNMG-120408-E-ZNM	0,8	4,76	9,61

8515 - DCGT P - 010. Acabado/Semi desbaste/Desbaste

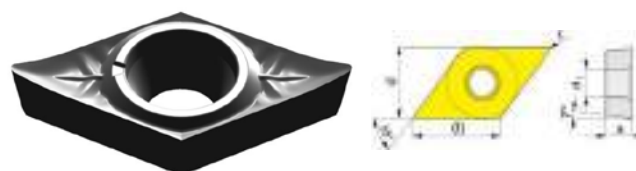

Ref.	Código	d mm	d1 mm	l mm	ISO	r mm	s mm	€/ u.
142935	29901	6,35	2,8	7,8	DCGT-070202-F-AL-P010	0,2	2,38	12,92
142936	29903	6,35	2,8	7,8	DCGT-070204-F-AL-P010	0,4	2,38	12,92
142937	29906	9,52	4,4	11,6	DCGT-11T302-F-AL-P010	0,2	3,97	14,02
142938	29910	9,52	4,4	11,6	DCGT-11T304-F-AL-P010	0,4	3,97	14,02

8515 - DCGT P - 620. Acabado/Semi desbaste/Desbaste

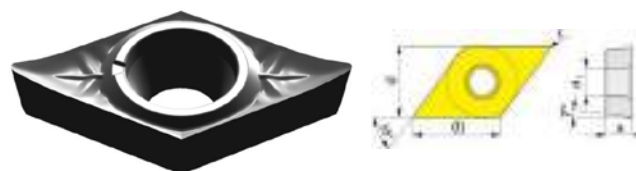

Ref.	Código	d mm	d1 mm	l mm	ISO	r mm	s mm	€/ u.
142950	29902	6,35	2,8	7,8	DCGT-070202-F-AL-P620	0,2	2,38	12,92
142951	29905	6,35	2,8	7,8	DCGT-070204-F-AL-P620	0,4	2,38	12,92
142952	29908	9,52	4,4	11,6	DCGT-11T302-F-AL-P620	0,2	3,97	14,02
142953	29911	9,52	4,4	11,6	DCGT-11T304-F-AL-P620	0,4	3,97	14,02

8520 - DCMT C - 525. Acabado

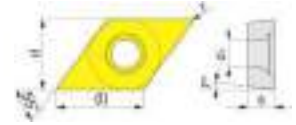

Ref.	Código	d mm	d1 mm	l mm	ISO	r mm	s mm	€/ u.
143000	26295	6,35	2,8	7,8	DCMT-070204-E-ZRR	0,4	2,38	8,50
143001	26296	9,525	4,4	11,6	DCMT-11T304-E-ZRR	0,4	3,97	8,50
143002	26298	9,525	4,4	11,6	DCMT-11T308-E-ZRR	0,8	3,97	8,50

8520 - DCMT P - 625. Acabado

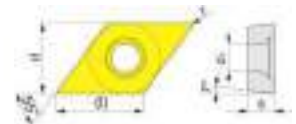

Ref.	Código	d mm	d1 mm	l mm	ISO	r mm	s mm	€/ u.
143011	17962	9,525	4,4	11,6	DCMT-11T304-E-ZRR	0,4	3,97	8,50
143012	28593	9,525	4,4	11,6	DCMT-11T308-E-ZRR	0,8	3,97	8,50

8520 - DCMT CERMET. Acabado



Ref.	Código	d mm	d1 mm	l mm	ISO	r mm	s mm	€/ u.
143020	19990	6,35	2,8	7,8	DCMT-070204-ZFCE	0,4	2,38	9,36
143021	19994	9,525	4,4	11,6	DCMT-11T304-ZFCE	0,4	3,97	12,98
143022	19996	9,525	4,4	11,6	DCMT-11T308-ZFCE	0,8	3,97	12,98



8530 - DNMG C - 515



Acabado

Ref.	Código	d mm	d1 mm	l mm	ISO	r mm	s mm	€/ u.
143120	17965	12,7	5,16	15,5	DNMG-150404-E-ZF	0,4	4,76	13,28

Semi desbaste

Ref.	Código	d mm	d1 mm	l mm	ISO	r mm	s mm	€/ u.
143122	17973	12,7	5,16	15,5	DNMG-150408-E-ZM	0,8	4,76	13,28
143123	17977	12,7	5,16	15,5	DNMG-150608-E-ZM	0,8	6,35	14,02
143124	17997	12,7	5,16	15,5	DNMG-150612-E-ZM	1,2	6,35	14,02

8530 - DNMG C - G15. Semi desbaste. Alto rendimiento

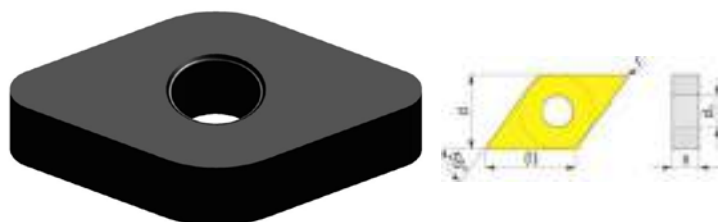

Ref.	Código	d mm	d1 mm	l mm	ISO	r mm	s mm	€/ u.
8000454	71285	12,7	5,16	15,5	DNMG-150404-ZPM	0,4	4,76	14,61
8000455	71287	12,7	5,16	15,5	DNMG-150408-ZPM	0,8	4,76	14,61
8000456	71289	12,7	5,16	15,5	DNMG-150608-ZPM	0,8	6,35	15,43

8530 - DNMG C - G25. Semi desbaste. Alto rendimiento

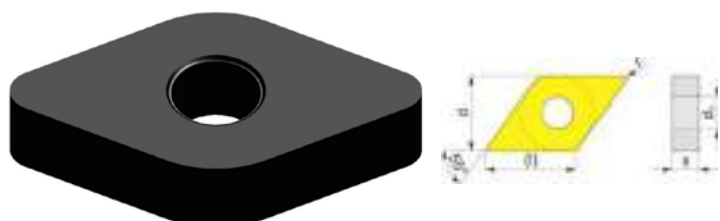

Ref.	Código	d mm	d1 mm	l mm	ISO	r mm	s mm	€/ u.
8000457	71286	12,7	5,16	15,5	DNMG-150404-ZPM	0,4	4,76	14,61
8000458	71288	12,7	5,16	15,5	DNMG-150408-ZPM	0,8	4,76	14,61
8000459	71290	12,7	5,16	15,5	DNMG-150608-ZPM	0,8	6,35	15,43

8530 - DNMG C - 525.



Acabado

Ref.	Código	d mm	d1 mm	l mm	ISO	r mm	s mm	€/ u.
143100	26299	12,7	5,16	15,5	DNMG-150404-E-ZF	0,4	4,76	13,28

Semi desbaste

Ref.	Código	d mm	d1 mm	l mm	ISO	r mm	s mm	€/ u.
143101	26301	9,525	3,81	11,6	DNMG-110408-E-ZM	0,8	4,76	9,61
143102	26302	12,7	5,16	15,5	DNMG-150408-E-ZM	0,8	4,76	13,28
143103	26304	12,7	5,16	15,5	DNMG-150608-E-ZM	0,8	6,35	14,02
143104	26305	12,7	5,16	15,5	DNMG-150612-E-ZM	1,2	6,35	14,02
143106	26272	12,7	5,16	15,5	DNMG-150608-EL-ZSX	0,8	4,76	14,02
143105	10341	12,7	5,16	15,5	DNMG-150608-ER-ZSX	0,8	4,76	14,02

8530 - DNMG C - 540. Semi desbaste



Ref.	Código	d mm	d1 mm	l mm	ISO	r mm	s mm	€/ u.
143130	15413	9,525	3,81	11,6	DNMG-110408-E-ZM	0,8	4,76	9,61
143131	17976	12,7	5,16	15,5	DNMG-150408-E-ZM	0,8	4,76	13,28
143132	17989	12,7	5,16	15,5	DNMG-150608-E-ZM	0,8	6,35	14,02
143133	18003	12,7	5,16	15,5	DNMG-150612-E-ZM	1,2	6,35	14,02

8530 - DNMG CERMET



Acabado

Ref.	Código	d mm	d1 mm	l mm	ISO	r mm	s mm	€/ u.
143140	20001	12,7	5,16	15,5	DNMG-150404-ZFCE	0,4	4,76	18,75

Semi acabado

Ref.	Código	d mm	d1 mm	l mm	ISO	r mm	s mm	€/ u.
143141	20002	12,7	5,16	15,5	DNMG-150404-ZMCE	0,8	4,76	18,75

8530 - DNMG P - 720. INOX



Ref.	Código	d mm	d1 mm	l mm	ISO	r mm	s mm	€/ u.
142955	35199	12,7	5,16	15,5	DNMG-150604-E-ZNM	0,4	6,35	14,02
142956	35200	12,7	5,16	15,5	DNMG-150608-E-ZNM	0,8	6,35	14,02

8540 - SCMT C - 525.

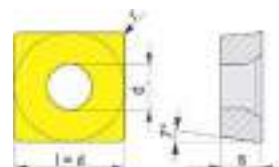

Acabado

Ref.	Código	d mm	d1 mm	l mm	ISO	r mm	s mm	€/ u.
143200	26307	9,525	4,4	9,525	SCMT-09T304-E-Z7	0,4	3,97	8,86
143201	26308	9,525	4,4	9,525	SCMT-09T308-E-Z7	0,8	3,97	8,86

Semi acabado

Ref.	Código	d mm	d1 mm	l mm	ISO	r mm	s mm	€/ u.
143202	26310	12,7	5,5	12,7	SCMT-120408-E-Z8	0,8	4,76	10,70
143203	26311	12,7	5,5	12,7	SCMT-120412-E-Z8	1,2	4,76	10,70

Acabado fino

Ref.	Código	d mm	d1 mm	l mm	ISO	r mm	s mm	€/ u.
143204	18015	12,7	5,5	12,7	SCMT-120408-E-ZRR	0,8	4,76	10,70

8540 - SCMT P - 625. Acabado fino

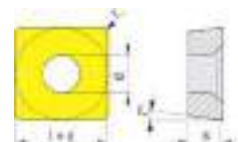

Ref.	Código	d mm	d1 mm	l mm	ISO	r mm	s mm	€/ u.
143210	18021	12,7	5,5	12,7	SCMT-120408-E-ZRR	0,8	4,76	10,70

8550 - SNMG C - 515.

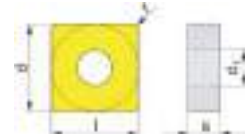

Acabado

Ref.	Código	d mm	d1 mm	l mm	ISO	r mm	s mm	€/ u.
143310	18039	12,7	5,16	12,7	SNMG-120404-E-ZFM	0,4	4,76	9,60

Semi desbaste

Ref.	Código	d mm	d1 mm	l mm	ISO	r mm	s mm	€/ u.
143311	18045	12,7	5,16	12,7	SNMG-120408-E-ZM	0,8	4,76	9,60
143312	18047	12,7	5,16	12,7	SNMG-120412-E-ZM	1,2	4,76	9,60

Desbaste

Ref.	Código	d mm	d1 mm	l mm	ISO	r mm	s mm	€/ u.
143314	18085	12,7	5,16	12,7	SNMG-120412-E-ZR	1,2	4,76	9,60

8550 - SNMG C - 525

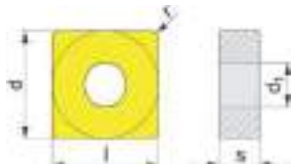

Acabado

Ref.	Código	d mm	d1 mm	l mm	ISO	r mm	s mm	€/ u.
143300	26313	12,7	5,16	12,7	SNMG-120404-E-ZFM	0,4	4,76	9,60

Semi desbaste

Ref.	Código	d mm	d1 mm	l mm	ISO	r mm	s mm	€/ u.
143301	26314	12,7	5,16	12,7	SNMG-120408-E-ZM	0,8	4,76	9,60
143302	26316	12,7	5,16	12,7	SNMG-120412-E-ZM	1,2	4,76	9,60

Desbaste

Ref.	Código	d mm	d1 mm	l mm	ISO	r mm	s mm	€/ u.
143303	18078	12,7	5,16	12,7	SNMG-120408-E-ZR	0,8	4,76	9,60



8550 - SNMG C - 540

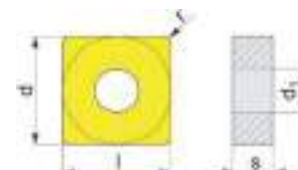

Semi desbaste

Ref.	Código	d mm	d1 mm	l mm	ISO	r mm	s mm	€/ u.
143321	18055	12,7	5,16	12,7	SNMG-120412-E-ZM	1,2	4,76	9,60

Desbaste

Ref.	Código	d mm	d1 mm	l mm	ISO	r mm	s mm	€/ u.
143322	18079	12,7	5,16	12,7	SNMG-120408-E-ZR	0,8	4,76	9,60
143323	18171	12,7	5,16	12,7	SNMG-120412-E-ZR	1,2	4,76	9,60

8550 - SNMG P - 625. Acabado

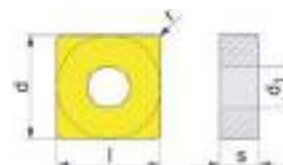

Ref.	Código	d mm	d1 mm	l mm	ISO	r mm	s mm	€/ u.
143330	18044	12,7	5,16	12,7	SNMG-120404-E-ZFM	0,4	4,76	9,60

8560 - TCMT C - 525. Semi desbaste

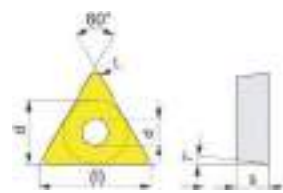

Ref.	Código	d mm	d1 mm	l mm	ISO	r mm	s mm	€/ u.
143400	26323	9,525	4,4	16,5	TCMT-16T308-E-ZRR	0,8	3,97	8,86
143503	10778	9,525	4,4	16,5	TCMT-16T308-E-ZRR	0,8	3,97	8,86

8560 - TCMT P - 625. Acabado

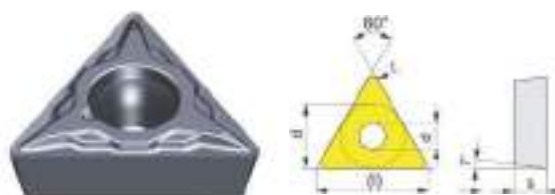

Ref.	Código	d mm	d1 mm	l mm	ISO	r mm	s mm	€/ u.
143500	26317	6,350	2,8	11,0	TCMT-110202-ZMM	0,2	2,38	8,50
143501	26320	6,350	2,8	11,0	TCMT-110204-ZMM	0,4	2,38	8,50
143502	26322	9,525	4,4	16,5	TCMT-16T304-ZMM	0,4	3,97	8,86

8570 - TNMG C - 515



Acabado

Ref.	Código	d mm	d1 mm	l mm	ISO	r mm	s mm	€/ u.
143620	18811	9,525	3,81	16,5	TNMG-160404-E-ZFM	0,4	4,76	9,60
142960	42922	9,52	3,81	16,5	TNMG-160408-E-ZFM	0,8	4,76	9,60

Semi desbaste

Ref.	Código	d mm	d1 mm	l mm	ISO	r mm	s mm	€/ u.
143621	18924	9,525	3,81	16,5	TNMG-160408-E-ZM	0,8	4,76	9,60

Desbaste

Ref.	Código	d mm	d1 mm	l mm	ISO	r mm	s mm	€/ u.
143622	19213	12,7	5,16	22,0	TNMG-220408-E-ZR	0,8	4,76	14,02
143623	19228	12,7	5,16	22,0	TNMG-220412-E-ZR	1,2	4,76	14,02

03



8570 - TNMG C - 525.



Acabado

Ref.	Código	d mm	d1 mm	l mm	ISO	r mm	s mm	€/ u.
143600	26325	9,525	3,81	16,5	TNMG-160404-E-ZFM	0,4	4,76	9,60
142961	42924	9,52	3,81	16,5	TNMG-160408-E-ZFM	0,8	4,76	9,60

Semi desbaste

Ref.	Código	d mm	d1 mm	l mm	ISO	r mm	s mm	€/ u.
143601	26326	9,525	3,81	16,5	TNMG-160408-E-ZM	0,8	4,76	9,60
143602	26327	9,525	3,81	16,5	TNMG-160412-E-ZM	1,2	4,76	9,60
143605	11274	9,525	3,81	16,5	TNMG-160404-ER-ZSX	0,4	4,76	9,60
143607	11277	9,525	3,81	16,5	TNMG-160408-ER-ZSX	0,8	4,76	9,60
143606	11275	9,525	3,81	16,5	TNMG-160404-EL-ZSX	0,4	4,76	9,60
143608	11278	9,525	3,81	16,5	TNMG-160408-EL-ZSX	0,8	4,76	9,60

Desbaste

Ref.	Código	d mm	d1 mm	l mm	ISO	r mm	s mm	€/ u.
143603	26275	12,7	5,16	22,0	TNMG-220408-E-ZR	0,8	4,76	14,02
143604	11272	12,7	5,16	22,0	TNMG-220412-E-ZR	1,2	4,76	14,02

8570 - TNMG C - 540



Semi desbaste

Ref.	Código	d mm	d1 mm	l mm	ISO	r mm	s mm	€/ u.
143630	19006	9,525	3,81	16,5	TNMG-160408-E-ZM	0,8	4,76	9,60
143631	19195	9,525	3,81	16,5	TNMG-160412-E-ZM	1,2	4,76	9,60

Desbaste

Ref.	Código	d mm	d1 mm	l mm	ISO	r mm	s mm	€/ u.
143632	19215	12,7	5,16	22,0	TNMG-220408-E-ZR	0,8	4,76	14,02
143633	10790	12,7	5,16	22,0	TNMG-220412-E-ZR	1,2	4,76	14,02

8570 - TNMG CERMET



Acabado

Ref.	Código	d mm	d1 mm	l mm	ISO	r mm	s mm	€/ u.
143650	20032	9,525	3,81	16,5	TNMG-160404-ZFCE	0,4	4,76	13,69

Semiacabado

Ref.	Código	d mm	d1 mm	l mm	ISO	r mm	s mm	€/ u.
143651	20033	9,525	3,81	16,5	TNMG-160408-ZMCE	0,8	4,76	13,69

03

8570 - TNMG C - G15 Semi desbaste. Alto rendimiento

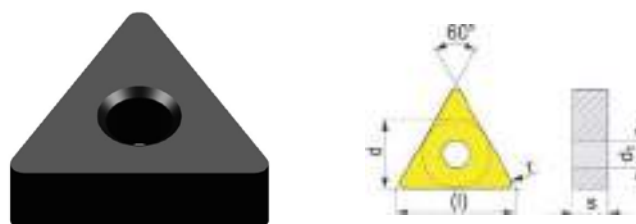

Ref.	Código	d mm	d1 mm	l mm	ISO	r mm	s mm	€/ u.
8000460	71291	12,7	5,16	15,5	TNMG-160404-ZPM	0,4	4,76	10,56
8000461	71293	12,7	5,16	15,5	TNMG-160408-ZPM	0,8	4,76	10,56
8000462	71295	12,7	5,16	15,5	TNMG-160412-ZPM	0,8	6,35	10,56

8570 - TNMG C - G25. Semi desbaste Alto rendimiento

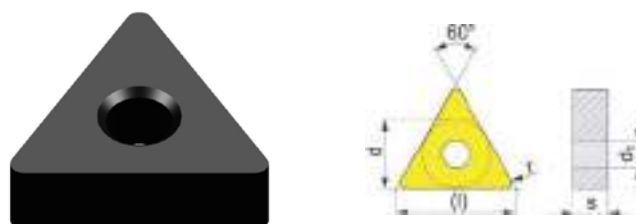

Ref.	Código	d mm	d1 mm	l mm	ISO	r mm	s mm	€/ u.
8000463	71292	12,7	5,16	15,5	TNMG-160404-ZPM	0,4	4,76	10,56
8000464	71294	12,7	5,16	15,5	TNMG-160408-ZPM	0,8	4,76	10,56
8000465	71296	12,7	5,16	15,5	TNMG-160412-ZPM	0,8	6,35	10,56



8570 - TNMG P - 625. Acabado

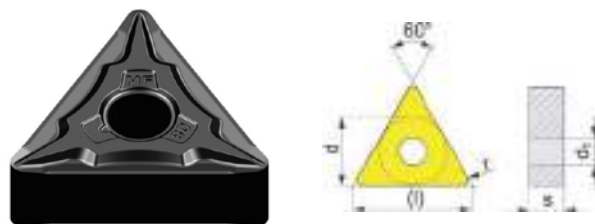

Ref.	Código	d mm	d1 mm	l mm	ISO	r mm	s mm	€/ u.
143640	18812	9,525	3,81	16,5	TNMG-160404-E-ZFM	0,4	4,76	9,60

8570 - TNMG P - 720. INOX

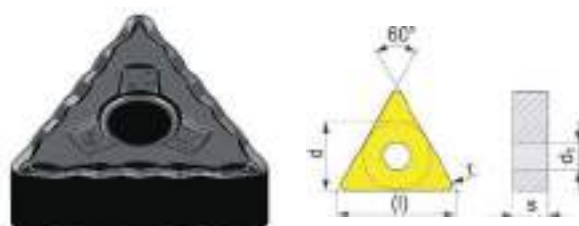

Ref.	Código	d mm	d1 mm	l mm	ISO	r mm	s mm	€/ u.
142962	35207	9,52	3,81	16,5	TNMG-160404-E-ZNM	0,4	4,76	9,60
142963	35209	9,52	3,81	16,5	TNMG-160408-E-ZNM	0,8	4,76	9,60

8571 - TPMR C - 515



Acabado

Ref.	Código	D mm_1	l mm	ISO	r mm	s mm	€/ u.
142965	29914	9,52	16,5	TPMR-160304-E-Z7-C515	0,4	3,18	8,50
142966	29915	9,52	16,5	TPMR-160308-E-Z7-C515	0,8	3,18	8,50
142967	29917	9,52	16,5	TPMR-160312-E-Z7-C515	1,2	3,18	8,50

Semi desbaste

Ref.	Código	D mm_1	l mm	ISO	r mm	s mm	€/ u.
142968	29919	9,52	16,5	TPMR-160308-E-Z1-C515	0,8	3,18	8,50

8571 - TPMR C - 525.



Acabado

Ref.	Código	D mm_1	l mm	ISO	r mm	s mm	€/ u.
142969	13406	9,52	16,5	TPMR-160304-E-Z7-C525	0,4	3,18	8,50
142970	13408	9,52	16,5	TPMR-160308-E-Z7-C525	0,8	3,18	8,50
142971	13411	9,52	16,5	TPMR-160312-E-Z7-C525	1,2	3,18	8,50

Semi desbaste

Ref.	Código	D mm_1	l mm	ISO	r mm	s mm	€/ u.
142972	13414	9,52	16,5	TPMR-160308-E-Z1-C525	0,8	3,18	8,50

8572 - TPUN C - 525. Acabado/Semi desbaste/Desbaste

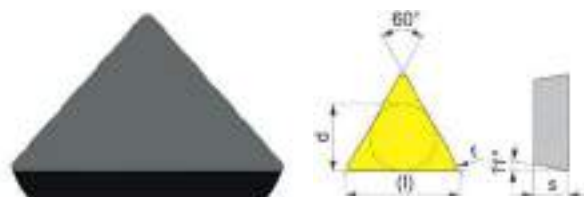

Ref.	Código	D mm_1	l mm	ISO	r mm	s mm	€/ u.
142973	11291	9,52	16,5	TPUN-160304-C525	0,4	3,18	9,23
142974	11292	9,52	16,5	TPUN-160308-C525	0,8	3,18	9,23
142975	11293	12,7	22	TPUN-220408-C525	0,8	4,76	12,55
142976	11295	12,7	22	TPUN-220412-C525	1,2	4,76	12,55

8572 - TPUN P - 620 Acabado/Semi desbaste/Desbaste

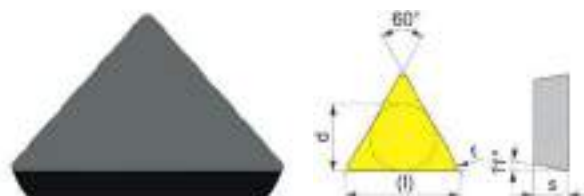

Ref.	Código	D mm_1	l mm	ISO	r mm	s mm	€/ u.
142977	29930	9,52	16,5	TPUN-160304-P620	0,4	3,18	9,23
142978	29933	9,52	16,5	TPUN-160308-P620	0,8	3,18	9,23
142979	29935	12,7	22	TPUN-220408-P620	0,8	4,76	12,55
142980	29937	12,7	22	TPUN-220412-P620	1,2	4,76	12,55



03

8580 - WNMG C - 515



Acabado

Ref.	Código	d mm	d1 mm	l mm	ISO	r mm	s mm	€/ u.
143720	19383	12,7	5,16	8,70	WNMG-080404-E-ZF	0,4	4,76	11,08

Semi desbaste

Ref.	Código	d mm	d1 mm	l mm	ISO	r mm	s mm	€/ u.
143721	19386	9,525	3,81	6,50	WNMG-060408-E-ZM	0,8	4,76	8,86
143722	19389	12,7	5,16	8,70	WNMG-080408-E-ZM	0,8	4,76	11,08
143723	13854	12,7	5,16	8,70	WNMG-080408-E-ZR	0,8	4,76	11,08
143724	13855	12,7	5,16	8,70	WNMG-080412-E-ZR	1,2	4,76	11,08

8580 - WNMG C - 525



Acabado

Ref.	Código	d mm	d1 mm	l mm	ISO	r mm	s mm	€/ u.
143700	26331	12,7	5,16	8,70	WNMG-080404-E-ZF	0,4	4,76	11,08
143702	30519	12,7	5,16	8,70	WNMG-080408-E-ZF	0,8	4,76	11,08

Semi desbaste

Ref.	Código	d mm	d1 mm	l mm	ISO	r mm	s mm	€/ u.
143701	26328	9,525	3,81	6,50	WNMG-060408-E-ZM	0,8	4,76	8,86
143703	26332	12,7	5,16	8,70	WNMG-080408-E-ZM	0,8	4,76	11,08
143704	26333	12,7	5,16	8,70	WNMG-080412-E-ZM	1,2	4,76	11,08
143705	11281	12,7	5,16	8,70	WNMG-080408-E-ZR	0,8	4,76	11,08
143706	11280	12,7	5,16	8,70	WNMG-080412-E-ZR	1,2	4,76	11,08

8580 - WNMG C - 525. Wiper



Ref.	Código	d mm	d1 mm	l mm	ISO	r mm	s mm	€/ u.
143712	19401	9,525	3,81	6,50	WNMG-060408-E-ZWM	0,8	4,76	9,60
143713	19402	9,525	3,81	6,50	WNMG-060412-E-ZWM	1,2	4,76	9,60
143714	19404	12,7	5,16	8,70	WNMG-080408-E-ZWM	0,8	4,76	11,81

8580 - WNMG C - 540. Semi desbaste



Ref.	Código	d mm	d1 mm	l mm	ISO	r mm	s mm	€/ u.
143731	19392	12,7	5,16	8,70	WNMG-080408-E-ZM	0,8	4,76	11,08
143732	19396	12,7	5,16	8,70	WNMG-080408-E-ZR	0,8	4,76	11,08
143733	19398	12,7	5,16	8,70	WNMG-080412-E-ZR	1,2	4,76	11,08

8580 - WNMG P - 720. INOX



Ref.	Código	d mm	d1 mm	l mm	ISO	r mm	s mm	€/ u.
143735	35210	12,7	5,16	8,70	WNMG-080404-E-ZNM	0,4	4,76	11,08
143736	35211	12,7	5,16	8,70	WNMG-080408-E-ZNM	0,8	4,76	11,08

8700 - MTJ-93°

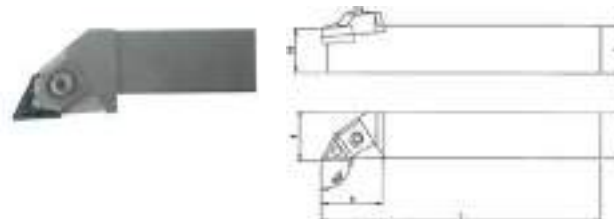

Ref.	Código	€ / u.	Ref.	Código	€ / u.	ISO	Forma de plaquita	A mm	b mm	c mm	E mm	f mm
143800	26431	101,79				MTJNR-2020K16	TNMG 1604..	20	20	125	34	25
143801	26434	107,74	143901	26437	107,74	MTJNL-2525M16	TNMG 1604..	25	25	150	34	32
143802	11296	107,74	143902	11298	107,74	MTJNL-2525M22	TNMG 2204..	25	25	150	42	32

8710 - MCL-95°

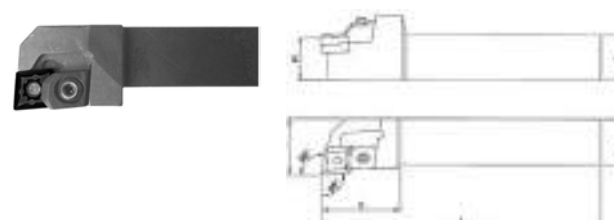

Ref.	Código	€ / u.	Ref.	Código	€ / u.	ISO	Forma de plaquita	A mm	b mm	c mm	E mm	f mm
144000	26439	101,79	144100	26440	101,79	MCLNR-2020K12	CNM. 1204..	20	20	125	34	25
144001	26442	107,74	144101	26443	107,74	MCLNR-2525M12	CNM. 1204..	25	25	150	34	32

8770 - MWL-95°

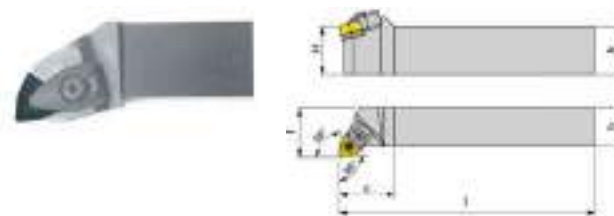

Ref.	Código	€ / u.	Ref.	Código	€ / u.	ISO	Forma de plaquita	b mm	c mm	f mm	H mm	L mm
147900	26499	101,79	147950	26500	101,79	MWLNL-2020K06	WNMG 0604..	20	25	25	20	125
147901	26502	107,74	147951	26503	107,74	MWLNL-2525M06	WNMG 0604..	25	25	32	25	150

03

8790 - DWL-95°

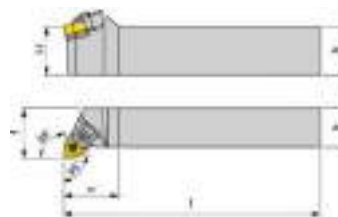

Ref.	Código	€/u.	Ref.	Código	€/u.	ISO	Forma de plaquita	b mm	c mm	f mm	H mm	L mm
148000	26511	104,82	148050	26512	104,82	DWLNR-2020K08	WNMG 0804..	20	34	25	20	125
148001	26514	110,58	148051	26515	110,58	DWLNR-2525M08	WNMG 0804..	25	34	32	25	150

8703 - STJ-93°

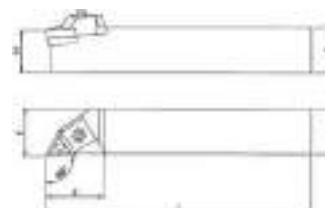

Ref.	Código	€/u.	Ref.	Código	€/u.	ISO	Forma de plaquita	b mm	c mm	f mm	H mm	L mm
148100	18596	91,93				STJCR-1616H11	TC..1102..	16	22	20	16	100
			148150	18649	91,93	STJCL-1616H11	TC..1102..	16	22	20	16	100
			148151	18664	98,92	STJCL-2020K16	TC..16T3..	20	22	25	20	125

8729 - SDJC-93°



Ref.	Código	€/u.	Ref.	Código	€/u.	ISO	Forma de plaquita	b mm	c mm	f mm	H mm	L mm
148200	29946	117,33	148250	29947	117,33	SDJCR-1010E07	DCGT DCMT 0702..	10	16	12	10	70
148201	29949	125,52	148251	29950	125,52	SDJCR-1212F07	DCGT DCMT 0702..	12	18	16	12	80
148202	29951	125,52	148252	29952	125,52	SDJCR-1212F11	DCGT DCMT 11T3..	12	18	16	12	80
148203	29953	130,01	148253	29954	130,01	SDJCR-1616H11	DCGT DCMT 11T3..	16	22	20	16	100

8751 - S - SCL-95°

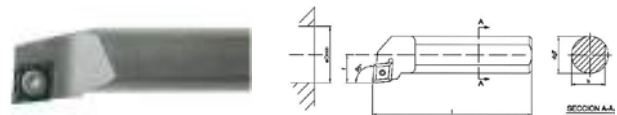

Ref.	Código	€ / u.	Ref.	Código	€ / u.	ISO	Forma de plaquita	D mm ₁	f mm	H mm	L mm
144800	19432	110,60	144900	19434	110,60	S08K-SCLCR-06	CCMT 060204	08	5	7	125
144801	19435	110,60	144901	19438	110,60	S10M-SCLCR-06	CCMT 060204	10	7	9	150
144802	26469	110,60	144902	26473	110,60	S12M-SCLCR-06	CCMT 060204	12	9	11	150
144803	19440	115,18	144903	19441	115,18	S16R-SCLCR-09	CCMT 09T308	16	11	15	200
144804	19443	145,20	144904	19444	145,20	S20S-SCLCR-09	CCMT 09T308	20	13	18	250

8791 - PSSN-45°

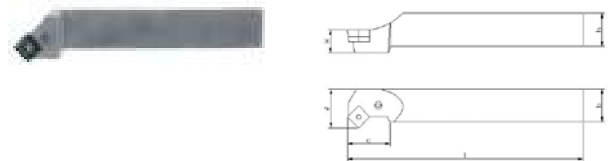

Ref.	Código	€ / u.	Ref.	Código	€ / u.	ISO	Forma de plaquita	b mm	c mm	f mm	H mm	L mm
147700	35223	99,84	147750	35224	99,84	PSSNR-2020K12	SNM. 1204..	20	28	25	20	125
147701	35225	105,68	147751	35226	105,68	PSSNR-2525M12	SNM. 1204..	25	28	32	25	150
147702	35227	115,62	147752	35228	115,62	PSSNR-3225P12	SNM. 1204..	25	28	32	32	170

8725 - PDJ-93°



Ref.	Código	€ / u.	Ref.	Código	€ / u.	ISO	Forma de plaquita	b mm	c mm	f mm	H mm	L mm
147800	13520	101,79	147850	13522	101,79	PDJNR-2020K11	DNM. 1104..	20	28	25	20	125
147801	11300	101,79	147851	11301	101,79	PDJNR-2020K15	DNM. 1506..	20	34	25	20	125

8812 - Accesorios



Ref.	Código	Descripción	€ / u.
146000	26556	Tornillo fijación por cuña-M8X1-23,7	18,01
146001	26557	Brida completa P/ MCLN	18,01
146003	10540	Tornillo fijación por cuña-M5X0,5-16,6X6,8	15,14
146004	10842	Brida completa P/ STJC-16	13,88
146100	10506	Llave TORX ZT-08	11,06
146101	10512	Llave TORX ZT-15	11,06
146105	13845	Llave TORX ZT-20	11,06
146104	10544	Tornillo allen 5-M3X0,8-7X4XØ5,5	1,84
146200	26560	Perno de cerradura-M3X0,5-Ø4,5X13,2X7,6	3,61
146201	26562	Pasador P/MCLN-20-25	3,61
146202	26563	Pasador P/ S-MCLN-12	11,04
146203	26553	Placa Base rómbica 80°-Ø7,4X12,45X12,45	11,43
146204	26554	Placa Base triangular-Ø6,6X11,95X13,55	7,75
146205	10567	Placa Base triagonal-Ø5,1X10,85X11,3	9,49
146206	10843	Placa Base P/DWLN-20-25	16,25



1101 Cono reductor DIN2185



Ref.	Código	CM exterior/interior	L mm	€/ u.
21057568	16415	2-1	92	19,38
21057569	16416	3-1	99	26,56
21057570	16417	3-2	112	26,94
21057571	16418	4-1	124	42,29
21057572	16419	4-2	124	42,29
21057573	16420	4-3	140	42,29
21057574	16421	5-3	156	65,04
21057575	16422	5-4	171	65,30



1102 Alargador conos DIN2187



Ref.	Código	CM exterior/interior	L mm	€/ u.
21057576	16423	1-2	160	46,87
21057577	16427	2-1	160	36,29
21057578	16433	2-2	175	48,05
21057579	16424	2-3	200	61,89
21057580	16428	3-1	175	38,71
21057581	16429	3-2	194	45,64
21057582	16434	3-3	215	69,93
21057583	16425	3-4	240	92,84
21057584	16430	4-1	200	64,75
21057585	16431	4-2	215	65,46
21057586	16432	4-3	240	76,24
21057587	16435	4-4	265	110,17
21057588	16426	4-5	300	218,14



1103 Espiga sujeción



Ref.	Código	CM/Cono Portabrocas	L mm	€/ u.
21057589	16440	1-B12	89	12,24
21057590	16441	2-B12	106	13,21
21057591	16442	2-B16	111	13,21
21057592	16443	2-B18	118	13,21
21057593	16444	3-B12	126	16,06
21057594	16445	3-B16	134	16,06
21057595	21873	3-B18	140	16,06
21057596	16446	4-B16	158	24,65
21057597	16447	4-B18	165	24,65
21057598	66764	5-B16	194	70,27
21057599	66765	5-B18	202	70,27



Hoja de sierra de mano, acero rápido



Hoja en acero rápido, totalmente templada. Aconsejable para todo tipo de cortes, incluso en materiales de difícil mecanización. Recomendada para utilizar con tornillo de banco. Con recubrimiento anti-óxido azul.

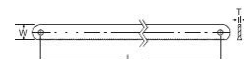

Ref.	Código	Longitud mm	W mm	H mm	Dientes por pulgada	€/ u.
1201210	3905-250-24-100	250	13	0.65	24	2,20
1201211	3905-300-14-100	300	13	0.65	14	2,30
1201212	3905-300-18-100	300	13	0.65	18	2,30
1201213	3905-300-24-2P	300	13	0.65	24	5,99
1201214	3905-300-24-100	300	13	0.65	24	2,30
1201215	3905-300-32-100	300	13	0.65	32	2,15



Hojas de sierra de mano, bimetel

La hoja de sierra bi-metal es virtualmente inastillable e irrompible y tiene un dentado rectificando con precisión para cortar toda clase de metales. El lomo fabricado en acero para muelles, flexible y robusto, y el dentado realizado en acero rápido de alta resistencia, garantizan que los dientes permanezcan perfectamente afilados durante mucho más tiempo. La hoja Sandflex® combina una excelente capacidad de corte y una mayor resistencia con un alto grado de flexibilidad, ofreciendo un rendimiento muy superior al resto de hojas de sierra convencionales.



Ref.	Código	Longitud mm	W mm	H mm	Dientes por pulgada	€/ u.
1201190	3906-250-18-100	250	13	0,65	18	1,93
1201191	3906-250-24-100	250	13	0,65	24	1,93
1201192	3906-250-32-100	250	13	0,65	32	1,93
1201193	3906-300-14-100	300	13	0,65	14	2,17
1201194	3906-300-18-100	300	13	0,65	18	2,17
1201195	3906-300-24-100	300	13	0,65	24	2,17
1201196	3906-300-32-100	300	13	0,65	32	2,17
1201197	3906-300-18-2P	300	13	0,65	18	5,99
1201198	3906-300-24-2P	300	13	0,65	24	5,99
1201199	3906-300-32-2P	300	13	0,65	32	5,99
1201200	3906-300-3P	300	13	0,65	18/24/32	8,70
1201201	3906-300-18-5P	300	13	0,65	18	14,05
1201202	3906-300-24-5P	300	13	0,65	24	14,05
1201203	3906-300-32-5P	300	13	0,65	32	14,05
1201204	3906-300-18-10P	300	13	0,65	18	21,68
1201205	3906-300-24-10P	300	13	0,65	24	27,59
1201206	3906-300-32-10P	300	13	0,65	32	27,59

Hoja de sierra de calar



Cortes rápidos en madera blanda y materiales no abrasivos para trabajo en madera. La hoja de sierra de calar T 144 D Speed for Wood proporciona cortes rectos y rápidos en madera. Los dientes fresados afilados y de corte libre triscado permiten obtener resultados rápidamente. El material de acero con alto contenido de carbono corta madera blanda y materiales no abrasivos para trabajos en madera. La separación amplia y progresiva de dientes (4-5,2 mm) corta distintos materiales de madera con un grosor de 5 a 50 mm



Ref.	Código	Descripción	Aplicación	Material	Modelos de dientes	L [mm]	€/ u.
2400718	2608630040	T 144 D: Speed wood: 5uds	Madera blanda, Aglomerado	HCS	Triscado, rectificando	100	9,57
2400719	2608637944	T 344 D: Speed wood: 3uds	Madera blanda, Madera de construcción	HCS	Triscado, rectificando	152	10,58
2400720	2608630559	T 101 AO curva: Clean for wood: 3uds	Madera blanda, Contrachapado	HCS	dentado inclinado, afilado con dientes y ángulo de incidencia	83	7,05
2400721	2608630030	T 101 B: Clean wood: 5uds	Madera blanda, Contrachapado	HCS	afilado con dientes y ángulo de incidencia	100	10,65
2400722	2608633A32	T 344 DP: Precision wood: 3uds	Madera blanda; Madera de construcción	HCS	Triscado, rectificando	152	13,75
2400723	2608636431	T 101 BIF: Special Laminate: 5uds	Vinilo laminado sólido, PVC, Laminado	BIM	afilado con dientes y ángulo de incidencia	83	21,30
2400724	2608631013	T 118 A: Basic Metal: 5uds	Láminas de acero, Láminas de acero	HSS	ondulado, fresado	92	10,65

Juegos de sierras de calar



Ref.	Código	Descripción	€ / u.
2400725	2608631319	T 318 A: Basic Metal: 5uds	13,86
2400726	2607010630	Set calar: Basic Wood+Metal: 10uds	15,91
2400727	2607011436	Set calar 14+1 endurance for Wood (incl. 1 endurance Wood)	41,53
2400728	2607011437	Set calar 14+1 endurance Wood + Metal (incl. 1 endurance Wood)	40,09
2400729	2607011438	Set calar 14+1 endurance MultiMaterial (incl. 1 progressor W+M)	37,04

Hoja de sierra de calar EXPERT



Carbide Technology para un rendimiento de larga duración. Durabilidad excepcional integrada con Bosch Carbide Technology. Compatible con todas las sierras de calar con vástago de inserción en T. Ideal para realizar cortes rectos en cartón-yeso, como recortes en paneles de cartón-yeso y para realizar cortes de ajuste al instalar planchas de fibrocemento. Lo mejor para los trabajadores de la construcción: duraderos y versátiles.



Ref.	Código	Descripción	Aplicación	Material	Modelos de dientes	L [mm]	€ / u.
2400730	2608900563	EXPERT T141HM: Fiber Plaster: 3uds	Tableros de fibrocemento, Panel de cartón-yeso	Carburo	Triscado	100	44,24
2400731	2608900564	EXPERT T341HM: Fiber Plaster: 3uds	Tableros de fibrocemento; Panel de cartón-yeso; Hormigón celular	Carburo	Triscado	132	46,37
2400732	2608900566	EXPERT T301CHM: Plastic Composites clean: 3uds	Madera plástica WPC, Compuesto de superficie sólida	Carburo	Carbide Technology (listón), afilado con dientes	117	50,44
2400733	2608900541	EXPERT T144DHM: Hard Wood fast: 3uds	Madera dura, Madera plástica WPC	Carburo	Equipado con metal duro (listón), afilado con dientes	100	35,99
2400734	2608900560	EXPERT T367XHM: Multimaterial: 3uds	Acero resistente; Aluminio; Madera con metal duro; Madera de construcción con mortero y clavos; Plásticos	Carburo	Equipado con metal duro (listón), afilado con dientes	132	54,99
2400735	2608900561	EXPERT T118AHM: Stainless Steel: 3uds	Láminas de acero inoxidable, Láminas de acero inoxidable	Carburo	rectificada	83	31,60
2400736	2608900565	EXPERT T108BHM: Carbon Fiber clean: 3uds	Plásticos con fibra GFK, CFK, Plásticos con fibra GFK, CFK	Carburo	Carbide Technology (listón), afilado con dientes	92	36,03
2400737	2608900544	EXPERT T308BFP: Hardwood 2-side clean: 5uds	Tableros recubiertos de plástico, Tablero multiplex	BIM	afilado con dientes y ángulo de incidencia	117	23,43
2400738	2608900562	EXPERT T118EHM: Stainless Steel: 3uds	Láminas de acero inoxidable, Láminas de acero inoxidable	Carburo	rectificada	83	31,60
2400739	2608900548	EXPERT T308BFP: Hardwood 2-side clean precision: 5uds	Tableros recubiertos de plástico, Encimera de cocina	BIM	afilado con dientes y ángulo de incidencia	117	26,09
2400740	2608900550	EXPERT T308B: Wood 2-side clean: 3uds	Tablero para mobiliario de madera maciza, Contrachapado	HCS	afilado con dientes y ángulo de incidencia	117	9,86



Cinta de sierra bimetálica M42



Hoja de sierra sinfín metálica de alto rendimiento con cinta portadora de acero para resortes y filo de HSS-M42-cobalto. Alta productividad gracias al reducido cambio de hoja al cortar diferentes secciones de materiales gracias al dentado variable en las cintas combinadas. Para serrar materiales de diferente calidad hasta aleaciones de acero para herramientas y acero rápido, así como aceros inoxidables y resistentes al ácido.



Ref.	Código	Dimensiones mm	€/u.
5410103	5410103	1.470 x 13 x 0,65	35,49
5410106	5410106	1.638 x 13 x 0,65	38,45
5410109	5410109	2.000 x 20 x 0,90	50,82
5410112	5410112	2.060 x 20 x 0,90	52,06
5410115	5410115	2.070 x 20 x 0,90	52,27
5410118	5410118	2.080 x 20 x 0,90	52,47
5410121	5410121	2.090 x 20 x 0,90	52,47
5410124	5410124	2.360 x 20 x 0,90	58,24
5410127	5410127	2.362 x 20 x 0,90	58,29
5410130	5410130	2.450 x 27 x 0,90	60,10
5410133	5410133	2.460 x 27 x 0,90	60,31
5410136	5410136	2.600 x 27 x 0,90	63,20
5410139	5410139	2.700 x 27 x 0,90	65,27
5410142	5410142	2.750 x 27 x 0,90	66,30
5410145	5410145	2.755 x 27 x 0,90	66,40
5410148	5410148	2.770 x 27 x 0,90	66,71
5410151	5410151	2.825 x 27 x 0,90	67,84
5410154	5410154	2.835 x 27 x 0,90	68,05
5410157	5410157	2.845 x 27 x 0,90	68,25
5410160	5410160	2.850 x 27 x 0,90	68,36

Ref.	Código	Dimensiones mm	€/u.
5410163	5410163	2.945 x 27 x 0,90	70,32
5410166	5410166	2.950 x 27 x 0,90	71,41
5410169	5410169	3.010 x 27 x 0,90	71,66
5410172	5410172	3.100 x 27 x 0,90	73,52
5410175	5410175	3.180 x 27 x 0,90	75,17
5410178	5410178	3.505 x 27 x 0,90	81,87
5410181	5410181	3.505 x 34 x 1,10	99,21
5410184	5410184	3.660 x 27 x 0,90	85,07
5410187	5410187	3.720 x 34 x 1,10	104,51
5410190	5410190	4.090 x 27 x 0,90	93,94
5410193	5410193	4.100 x 34 x 1,10	113,87
5410196	5410196	4.135 x 34 x 1,10	114,73
5410199	5410199	4.570 x 34 x 1,10	125,44
5410202	5410202	4.860 x 34 x 1,10	132,58
5410205	5410205	4.990 x 34 x 1,10	135,79
5410208	5410208	5.145 x 34 x 1,10	139,60
5410211	5410211	5.334 x 41 x 1,30	204,63
5410214	5410214	5.800 x 41 x 1,30	221,17
5410217	5410217	6.585 x 41 x 1,30	249,03
5410220	5410220	6.900 x 41 x 1,30	260,21

325 - Arco de sierra para metales - profesional



Arco de sierra diseñado según los procesos científicos ERGO™. Un arco de sierra único y profesional. Mangos de agarre ergonómicamente diseñados. Sólida estructura de aluminio que permite una tensión de la hoja muy elevada, para cortes precisos y exactos. Hoja centrada para un buen balance y mayor precisión. Dispone de un mecanismo de tensión de la hoja accionado por muelle, para un fácil cambio de hoja. Montaje alternativo de 55° para corte a nivel. Se suministra con una hoja Sandflex® bi-metal de 12" (300 mm), 24 TPI, irrompible e inastillable, con excelente capacidad de corte.

Ref.	Código	Longitud mm	Peso grs.	€/u.
1200335	325	300	720	48,23



225-PLUS - Arco de sierra para metales - profesional



Arco de sierra profesional y robusto para metales. Permite una tensión de la hoja muy elevada, para cortes precisos y exactos. Dispone de un mecanismo de tensión de la hoja accionado por muelle, para un fácil cambio de hoja. La parte superior del arco es hueca y se puede utilizar para el almacenaje de hojas. Puede emplearse también como una sierra de calar. Montaje alternativo de 55° para corte a nivel. Se suministra con una hoja Sandflex® bi-metal de 12" (300 mm), 24 TPI, irrompible e inastillable, con excelente capacidad de corte.

Ref.	Código	Longitud mm	Peso grs.	€/u.
1200336	225-PLUS	300	700	31,08



319 - Arco de sierra para metales - profesional



Un arco de sierra único y profesional. Mangos de agarre ergonómicamente diseñados. Estructura realizada en acero, recubierta con plástico que permite una tensión elevada de la hoja y cortes precisos. Montaje alternativo de 55° para corte a nivel. Se suministra con una hoja Sandflex® bi-metal de 12" (300 mm), 24 TPI, irrompible e inastillable, con excelente capacidad de corte.

Ref.	Código	Longitud mm	Peso grs.	€ / u.
1200337	319	300	510	26,91



317 - Arco de sierra para metales - compacto



Cómodo arco de sierra para todo tipo de cortes. Su reducido tamaño mejora el acceso a espacios reducidos y facilita el almacenaje. La zona de agarre frontal ofrece una zona de apoyo perfecta para la mano, mejorando considerablemente el rendimiento. Montaje alternativo de 90° para corte a nivel. Se suministra con una hoja Sandflex® bi-metal de 12" (300 mm), 24 TPI, irrompible e inastillable, con excelente capacidad de corte.

Ref.	Código	Longitud mm	Peso grs.	€ / u.
1200338	317	432	470	19,50



306 - Arco de sierra para metales - compacto



Arco de sierra ligero para trabajos ocasionales. Montaje alternativo de 90° para corte a nivel. Se suministra con una hoja Sandflex® bi-metal de 12" (300 mm), 24 TPI, irrompible e inastillable, con excelente capacidad de corte.

Ref.	Código	Longitud mm	Peso grs.	€ / u.
1200339	306	470	325	15,14



Arco de sierra de aluminio



Arco de sierra en aluminio de 300 mm. Con hoja bimetálica

Ref.	Código	Longitud mm	€ / u.
8005571	811	300	16,05



320 - Arco de sierra tradicional



Arco de sierra tradicional de alta gama con mango cómodo y de altura extra que permite el corte de materiales de dimensiones grandes. El agarre especial desde el frente proporciona un buen apoyo para la mano guiadora para un rendimiento excelente. Montaje alternativo a 90° para corte a nivel. Se suministra con una hoja Sandflex® bi-metal de 12" (300 mm), 24 TPI, irrompible e inastillable, con excelente capacidad de corte.

Ref.	Código	Longitud mm	Peso grs.	€ / u.
1200340	320	504	820	22,40



304 - Arco de sierra



Arco de sierra tradicional y standard, fácil de usar. Montaje alternativo a 90° para corte a nivel. Se suministra con una hoja Sandflex® bi-metal de 12" (300 mm), 24 TPI, irrompible e inastillable, con excelente capacidad de corte.

Ref.	Código	Longitud mm	Peso grs.	€ / u.
1200341	304	517	500	7,89



208 - Mini arco de sierra para metales



Mini-arco de sierra para espacios de difícil acceso. Fácil manejo. Se suministra con una hoja Sandflex® bi-metal de 10" (250 mm), 24 TPI, irrompible e inastillable, con excelente capacidad de corte.

Ref.	Código	Longitud mm	Peso grs.	€ / u.
1200342	208	330	149	16,53



129 - 119-B Arco de sierra



pletina

Ref.	Código	Hoja	Medidas	Pletina	€ / u.
1259221	1011219	12"	480 x 100	18 x 5	16,91



12 - 219 Arco de sierra



12- Tubo acero ovalado de 2mm. de espesor. Protector de mano. Hoja de acero al carbono.

Ref.	Código	Hoja	Medidas mm	Tubo mm	€ / u.
8000218	1020219	12"	400x150	25x12x1,5	23,86



4551 - Serrucho de carpintero



Fabricados con Acero Especial Bellota. Dentado japonés afilado por tres caras para mayor facilidad y limpieza de corte. Doble tratamiento térmico para conseguir un mayor rendimiento: temple integral en la hoja y temple extra-duro en los dientes. Mango diseñado para transmitir la máxima fuerza a lo largo de todo el dentado. Dos tipos de mangos: - Mangos de madera barnizados, ligeros y de tacto agradable. Usos: Para corte de madera, aglomerado, yeso, plástico y otros materiales.



Ref.	Código	A mm	b mm	€/ u.
146450	4551-16	400	4,5	29,72
146451	4551-19	475	4,5	34,10
1258804	4551-22	550	4,5	37,84

4554 - Serrucho de carpintero



Fabricados con Acero Especial Bellota. Dentado japonés afilado por tres caras para mayor facilidad y limpieza de corte. Doble tratamiento térmico para conseguir un mayor rendimiento: temple integral en la hoja y temple extra-duro en los dientes. Mango diseñado para transmitir la máxima fuerza a lo largo de todo el dentado. Dos tipos de mangos: - Mangos de madera barnizados, ligeros y de tacto agradable. Usos: Para corte de madera, aglomerado, yeso, plástico y otros materiales.



Ref.	Código	A mm	b mm	€/ u.
1258900	4555-14	350	4	23,50
1258901	4555-16	400	4	24,82
146550	4555-19	475	4,5	28,52
1258904	4555-22	550	4,5	32,13

4561 - Serrucho de carpintero



Nervio en la zona superior de la hoja que garantiza rigidez durante el corte.

Ref.	Código	A mm	b mm	€/ u.
1259001	4561-12	300	2,8	36,36
1259002	4561-14	350	2,8	38,88



4565 - Serrucho de carpintero



Nervio en la zona superior de la hoja que garantiza rigidez durante el corte. Mango bimaternal

Ref.	Código	A mm	b mm	€/ u.
1259101	4565-12	300	2,8	32,43
1259103	4565-14	350	2,8	34,97



4520 - Serrucho teflonado



Extremo de la hoja en punta que facilita el corte en encuentros techo-paredes. Para corte de placa de yeso

Ref.	Código	A mm	b mm	€ / u.
1259120	4520-15	375	2,8	31,28



Sierra para tubería de plástico PVC/ABS



Geometría exclusiva de los dientes para corte de tracción en cualquier tipo de plástico o madera. Dureza de dientes Hrc 63-66. Dientes fresados. Ancho de lomo 2 1/2"-64mm.

Ref.	Código	Descripción	€ / u.
1279800	20985	Mango y hoja de 300 mm	47,53
1279801	20980	Mango y hoja de 450 mm	52,83
1279803	20982	Hoja de repuesto de 300 mm	23,92



Sierra para tubería de plástico PVC/ABS



Geometría exclusiva de los dientes para corte de tracción en cualquier tipo de plástico o madera. Dureza de dientes Hrc 63-66. Dientes fresados. Ancho de lomo 2 1/2"-64mm.

Ref.	Código	Descripción	€ / u.
1279850	20997	Sierra Tri-Ford con dos hojas para cortes de yeso, maderas y metales.	56,06



Husillo para coronas



Los husillos para coronas sirven de base para la corona y para la broca de centrado. PFERD ofrece tres tamaños distintos. El mango adecuado se elige en función del diámetro de la corona y de la máquina a utilizar. Utilización de muelles de expulsión: Evita el atasco del material serrado dentro de la pared interior de la corona. El material se expulsa con la fuerza del muelle. Si no se deseara este efecto en una determinada aplicación como, por ej., tubos ya montados, se puede desmontar el muelle manualmente sin herramienta auxiliar.

Ref.	Código	Ø Mango mm	Adecuado para coronas de Ø	Forma del mango	Rosca	€ / u.
2321270	LSS 1 9,53 mm	9,53	LS 14-30	Hexagonal	1/2-20 UNF	20,68
2321271	LSS 2 9,53 mm	9,53	LS 32-152	Hexagonal	5/8-18 UNF	31,43
2321272	LSS 4 6,35 mm	6,35	LS 14-30	Redondo	1/2-20 UNF	15,46



Broca de centrado para corona



Ref.	Código	Ø mango mm	Adecuado para coronas de Ø	Forma del mango	Mangos adecuados	€ / u.
2321275	LSB 6/60	6,35	LS 14-152	redondo	LSS 1, LSS 2	8,34
2321276	LSB 6/90	6,35	LS 14-152	redondo	LSS 4	8,81



Corona HSS



Las coronas de acero rápido (HSS) bimetálicas son resistentes a la rotura y estables. Se utilizan en mandrinadoras estacionarias y taladros portátiles.

Ventajas:

- Serrado económico de orificios redondos.
- De uso universal para el trabajo de distintos materiales como aceros aleados y sin alea, acero fino (INOX), fundición, aluminio, cobre, bronce, latón, madera, plásticos y otros.
- Las coronas distribuyen sus dientes de forma irregular lo que permite serrar sin vibraciones.
- PFERD ofrece una selección de las coronas HSS más habituales así como juegos para artesanos, instaladores, electricistas y montadores.
- El centrado y guiado de la corona se realiza con el mango HSS (que incluye muelle para extraer más fácilmente el material cortado).

Recomendaciones de uso: La broca de centrado debe estar integrada en el mango y sobresalir al menos 3 mm [1/8"] sobre los dientes de la corona. Al serrar metales es aconsejable usar aceite de corte de buena calidad. Con aceite de corte se consigue una marcha más tranquila y una mayor duración de la corona. Excepciones: No usar aceite de corte en el trabajo de materiales de aluminio, donde se utiliza petróleo en lugar de aceite. Las coronas HSS son adecuadas para el tratamiento de acero fino (INOX). Para evitar corrosión, se deben eliminar de la pieza de trabajo las partículas resultantes del proceso. Es recomendable una limpieza de la pieza de trabajo con medios químicos y mecánicos (decapar, pulir, etc.). Todos los dientes deben atacar uniformemente. Evitar movimientos pendulares al serrar para impedir roturas de dientes. Evitar el sobrecalentamiento de la corona.



03

Ref.	Código	Ø mm	Profundidad de corte máx. mm	r.p.m. inox	r.p.m. acero	r.p.m. latón	r.p.m. plástico	€ / u.
2123310	LS 14	14	34	310	620	800	1.000	15,90
2123311	LS 16	16	34	275	550	730	880	15,90
2123312	LS 17	17	36	260	520	680	820	15,90
2123313	LS 19	19	36	230	460	600	740	17,13
2123314	LS 20	20	36	210	425	560	700	17,13
2123315	LS 21	21	36	205	410	540	670	17,13
2123316	LS 22	22	36	195	390	520	640	17,13
2123317	LS 24	24	36	180	360	470	580	17,13
2123318	LS 25	25	36	175	350	470	560	18,25
2123319	LS 27	27	36	160	325	435	520	19,39
2123320	LS 29	29	36	150	300	400	480	19,39
2123321	LS 30	30	36	145	285	380	470	20,49
2123322	LS 32	32	36	140	275	360	440	20,62
2123323	LS 33	33	36	135	260	345	420	21,74
2123324	LS 35	35	36	125	250	330	400	21,74
2123325	LS 37	37	36	115	235	310	370	21,88
2123326	LS 38	38	36	115	230	300	370	21,74
2123327	LS 40	40	36	110	215	280	350	22,65
2123328	LS 41	41	36	105	210	280	340	22,65
2123329	LS 43	43	31	100	200	260	330	23,20
2123330	LS 44	44	31	95	195	260	320	26,02
2123331	LS 46	46	31	90	185	250	300	26,02
2123332	LS 48	48	31	90	180	240	290	26,50
2123333	LS 51	51	31	85	170	230	270	26,50
2123334	LS 52	52	31	80	165	220	270	29,68
2123335	LS 54	54	31	80	160	210	260	30,22
2123336	LS 57	57	31	75	150	200	250	30,41
2123337	LS 59	59	31	70	145	190	240	30,22
2123338	LS 60	60	31	70	140	190	230	30,77
2123339	LS 64	64	31	65	135	180	220	33,72
2123340	LS 65	65	31	60	135	180	220	34,33
2123341	LS 67	67	31	65	130	170	210	35,03
2123342	LS 68	68	31	65	130	170	210	35,41
2123343	LS 70	70	31	60	125	160	200	35,58
2123344	LS 73	73	31	60	120	160	190	35,58
2123345	LS 76	76	31	55	115	150	180	35,89
2123346	LS 79	79	31	55	110	140	180	35,89
2123347	LS 83	83	31	50	105	140	170	36,61
2123348	LS 86	86	31	50	100	130	160	37,11
2123349	LS 89	89	31	45	95	130	160	36,78
2123350	LS 92	92	31	45	95	120	150	43,23
2123351	LS 95	95	31	45	90	120	150	45,17
2123352	LS 98	98	31	45	90	120	140	47,85
2123353	LS 102	102	31	40	85	110	140	50,34
2123354	LS 105	105	31	40	80	110	130	56,56
2123355	LS 111	111	31	35	75	100	130	61,90
2123356	LS 114	114	31	35	75	100	120	63,81
2123357	LS 121	121	31	35	70	90	120	68,63
2123358	LS 127	127	31	30	65	80	110	69,71
2123359	LS 140	140	31	30	60	75	100	71,92
2123360	LS 152	152	31	25	55	70	90	76,22



3832 - Corona con dentado con plaquitas de metal duro (CT)



Las coronas de sierra con plaquitas de carburo de tungsteno pueden perforar ladrillo, cerámica, laminados, fibra de vidrio y madera dura al igual que acero. Se adaptan a todas las taladradoras eléctricas, tanto fijas como portátiles. Los agujeros permiten la fácil expulsión del material cortado. Máxima profundidad de corte 38 mm (1 1/2"). 4 dientes por pulgada. Diámetro máximo a perforar = tamaño nominal de la corona de sierra + 1,5 mm / - 0,0.



Ref.	Código	Diámetro mm	€/ u.
1201220	3832-14	14	20,00
1201221	3832-16	16	20,00
1201222	3832-17	17	20,00
1201223	3832-19	19	20,00
1201224	3832-20	20	20,00
1201225	3832-21	21	20,00
1201226	3832-22	22	20,00
1201227	3832-24	24	20,00
1201228	3832-25	25	21,09
1201229	3832-27	27	22,54
1201230	3832-29	29	22,54
1201231	3832-30	30	22,54
1201232	3832-32	32	22,54
1201233	3832-33	33	22,54
1201234	3832-35	35	25,08
1201235	3832-37	37	25,08
1201236	3832-38	38	25,08
1201237	3832-40	40	25,08
1201238	3832-41	41	25,08
1201239	3832-43	43	25,08
1201240	3832-44	44	29,09
1201241	3832-46	46	29,09
1201242	3832-48	48	29,09
1201243	3832-51	51	29,09
1201244	3832-52	52	35,28
1201245	3832-54	54	35,28
1201246	3832-56	56	35,28
1201247	3832-57	57	35,28

Ref.	Código	Diámetro mm	€/ u.
1201248	3832-59	59	35,28
1201249	3832-60	60	35,28
1201250	3832-64	64	38,90
1201251	3832-65	65	38,90
1201252	3832-67	67	38,90
1201253	3832-68	68	38,90
1201254	3832-70	70	38,90
1201255	3832-73	73	38,90
1201256	3832-76	76	43,28
1201257	3832-79	79	43,28
1201258	3832-83	83	43,28
1201259	3832-86	86	43,28
1201260	3832-89	89	43,28
1201261	3832-92	92	50,17
1201262	3832-95	95	54,91
1201263	3832-98	98	58,18
1201264	3832-102	102	61,07
1201265	3832-105	105	65,43
1201266	3832-108	108	76,72
1201267	3832-111	111	88,73
1201268	3832-114	114	98,54
1201269	3832-121	121	109,46
1201270	3832-127	127	120,37
1201271	3832-133	133	130,55
1201272	3832-140	140	141,46
1201273	3832-146	146	148,71
1201274	3832-152	152	161,80

3833-C - Corona con dentado de carburo



Corona de sierra de metal duro. Compatible con todo tipo de herramienta electroportátil. Excelente funcionamiento en madera, MDF, placas de yeso, chapa, plástico. Profundidad de corte extra, 71 mm. Tratamiento superficial anti-fricción. Diámetro máx. de perforación tamaño nominal de la corona +1,5mm / -0,0 mm. Código terminado -C envase con clip colgable y protector de dentado.



Ref.	Código	Diámetro mm	€/ u.
1200855	3833-19-C	19	13,22
1200856	3833-20-C	20	13,06
1200857	3833-22-C	22	13,19
1200858	3833-25-C	25	13,61
1200859	3833-27-C	27	14,20
1200860	3833-29-C	29	15,01
1200861	3833-30-C	30	14,83
1200862	3833-32-C	32	15,12
1200863	3833-35-C	35	16,97
1200864	3833-38-C	38	16,97
1200865	3833-40-C	40	17,27
1200866	3833-41-C	41	17,27
1200867	3833-44-C	44	20,31
1200868	3833-48-C	48	20,31
1200869	3833-51-C	51	20,81
1200870	3833-54-C	54	22,54
1200871	3833-57-C	57	23,48
1200872	3833-60-C	60	23,48
1200873	3833-64-C	64	23,61
1200874	3833-65-C	65	23,61
1200875	3833-67-C	67	23,61
1200876	3833-68-C	68	23,86

Ref.	Código	Diámetro mm	€/ u.
1200877	3833-70-C	70	24,05
1200878	3833-73-C	73	24,05
1200879	3833-76-C	76	24,94
1200880	3833-77-C	77	27,38
1200881	3833-79-C	79	27,38
1200882	3833-83-C	83	27,91
1200883	3833-86-C	86	28,11
1200884	3833-89-C	89	28,24
1200885	3833-92-C	92	29,05
1200886	3833-95-C	95	29,88
1200887	3833-98-C	98	30,39
1200888	3833-102-C	102	32,10
1200889	3833-105-C	105	32,40
1200890	3833-108-C	108	32,54
1200891	3833-109-C	109	35,44
1200892	3833-111-C	111	32,78
1200893	3833-114-C	114	35,52
1200894	3833-121-C	121	35,96
1200895	3833-127-C	127	37,91
1200896	3833-140-C	140	39,44
1200897	3833-152-C	152	42,41
1200898	3833-159-C	159	48,61

Corona bimetálica Progressor Wood Metal



Larga vida útil. La sierra de corona BiM Progressor ofrece el doble de vida útil que su predecesora. Rediseñada con bimetál Bosch, con un 8 % de aleación de cobalto para aumentar la durabilidad. La tira de dientes progresiva mejorada permite efectuar cortes más rápidos. Adecuada para diversos usos. Madera blanda; Cartón-yeso; Tubos y perfiles metálicos; Metales no ferrosos; Plásticos

Ref.	Código	Diámetro mm	Longitud de trabajo mm	€ / u.
2400741	2608594203	25	44	18,74
2400742	2608594207	32	44	20,42
2400743	2608594224	60	44	31,69
2400744	2608594228	68	44	33,36
2400745	2608594231	76	44	34,26
2400746	2608594233	83	44	35,55
2400747	2608594239	102	44	49,27



Corona de diamante DrySpeed



Larga vida útil en cerámicas duras. La corona de diamante Dry Speed proporciona larga vida útil al taladrar en seco cerámicas duras. Los diamantes de alta calidad proporcionan velocidades de perforación muy altas. La tecnología de soldadura al vacío garantiza una larga vida útil. Azulejos duros; Piedra dura; Ladrillos de cal y arena; Ladrillo macizo

Ref.	Código	Diámetro mm	Longitud de trabajo (L1) mm	€ / u.
2400748	2608599039	6	30	36,39
2400749	2608599040	8	30	37,79
2400750	2608599041	10	30	39,19
2400751	2608587119	30	35	97,52
2400752	2608587121	65	35	104,87



Corona de Diamante en seco M14



Coronas de Diamante en seco M14

Ref.	Código	Diámetro	€ / u.	Ref.	Código	Diámetro	€ / u.
8000904	507506	6	20,91	8000912	5075022	22	45,80
8000905	507508	8	24,03	8000913	5075025	25	49,17
8000906	5075010	10	25,97	8000914	5075035	35	61,96
8000907	5075012	12	28,39	8000915	5075045	45	70,90
8000908	5075014	14	31,05	8000916	5075050	50	81,52
8000909	5075015	15	31,77	8000917	5075060	60	96,49
8000910	5075018	18	39,02	8000918	5075065	65	102,28
8000911	5075020	20	42,16	8000919	5075068	68	108,07



Adaptador Coronas de diamante de M14 a HEX12



Adaptador de M14 a HEX12

Ref.	Código	Diámetro	€ / u.
8000920	50750M14	de M14 a HEX12	9,66



Corona de Diamante en seco HEX6,5



Coronas de Diamante en seco HEX6,5

Ref.	Código	Diámetro	€/u.
8000921	507516	6	21,40
8000922	507518	8	23,57
8000923	5075110	10	25,25
8000924	5075112	12	27,44
8000925	5075114	14	30,09



Kit Coronas de Diamante en seco M14



Kit Coronas de Diamante en seco M14

Ref.	Código	Diámetro	€/u.
8000926	50750KIT	6,8,10,12	101,32



Kit Coronas de Diamante en seco HEX6,5



Kit Coronas de Diamante en seco HEX6,5

Ref.	Código	Diámetro	€/u.
8000927	50751KIT	6,8,10,12	98,91





456
Muelas cilíndricas
dureza O



475
Pastas
de pulir



495
Discos de
corte

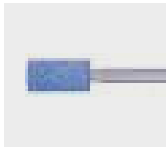

458
Muelas cilíndricas
dureza J



476
Hojas
Scotch-Brite



501
Discos de
desbaste



459
Abanicos
lijadores



478
Discos de lija



507
Cepillo
circular



463
Manguitos
lijadores



480
Clean &
Strip



511
Tazas



466
Rodillos
de lija



480
Discos de
fibra

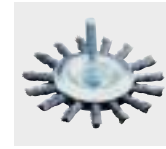

517
Discos
trenzados



467
Herramientas
de vellón



489
Discos de
láminas



518
Cepillos
limpiatubos



472
Muelas
de fieltro



495
Discos de
diamante

ABRASIVOS

04

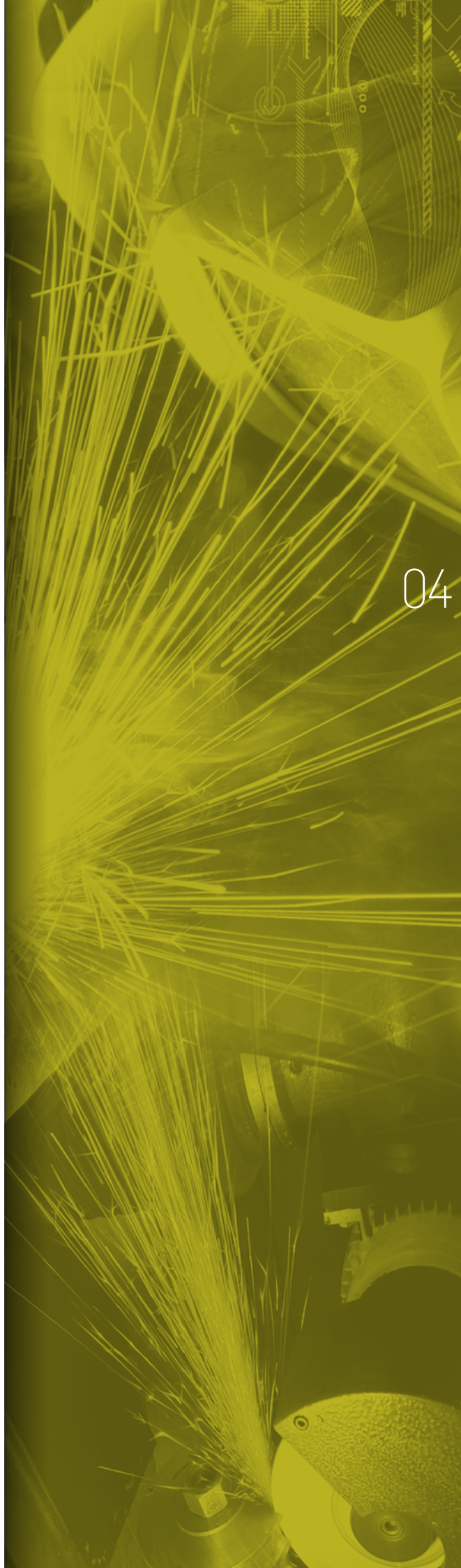

04

Muela cilíndrica ZY durezas O STEEL EDGE (canteado de acero) o M STEEL (superficies de acero)

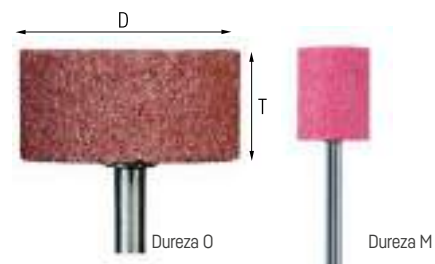

Ref.	Código	D mm	Ø Mango mm	T mm	€/u.
402710	ZY 0802 3 AR 100 05V STEEL EDGE	8,0	3	2	2,51
402713	ZY 0810 3 ADW 46 M5V STEEL	8,0	3	10	2,17
402714	ZY 0810 6 ADW 80 M5V STEEL	8,0	6	10	2,17
402715	ZY 0816 3 ADW 46 M5V STEEL	8,0	3	16	2,18
402716	ZY 0816 6 ADW 46 M5V STEEL	8,0	6	16	2,18
402717	ZY 1002 3 ADW 100 M5V STEEL	10,0	3	2	2,31
402718	ZY 1002 3 AR 100 05V STEEL EDGE	10,0	3	2	2,32
402720	ZY 1013 3 ADW 46 M5V STEEL	10,0	3	13	2,13
402721	ZY 1013 6 ADW 46 M5V STEEL	10,0	6	13	2,13
402722	ZY 1020 6 ADW 46 M5V STEEL	10,0	6	20	2,35
402723	ZY 1025 6 ADW 46 M5V STEEL	10,0	6	25	2,65
402724	ZY 1032 6 ADW 46 M5V STEEL	10,0	6	32	2,91
402725	ZY 1303 3 ADW 60 M5V STEEL	13,0	3	3	2,18
402726	ZY 1303 3 ADW 100 M5V STEEL	13,0	3	3	2,18
402729	ZY 1313 6 AR 80 05V STEEL EDGE	13,0	6	13	2,18
402730	ZY 1320 6 AR 80 05V STEEL EDGE	13,0	6	20	2,55
402731	ZY 1325 6 AR 46 05V STEEL EDGE	13,0	6	25	2,83
402732	ZY 1340 6 AR 46 05V STEEL EDGE	13,0	6	40	3,56
402733	ZY 1604 3 AR 46 05V STEEL EDGE	16,0	3	4	2,18
402734	ZY 1604 3 AR 80 05V STEEL EDGE	16,0	3	4	2,18
402736	ZY 1610 6 AR 30 05V STEEL EDGE	16,0	6	10	2,35
402737	ZY 1620 6 AR 30 05V STEEL EDGE	16,0	6	20	2,64
402738	ZY 1632 6 AR 60 05V STEEL EDGE	16,0	6	32	2,93
402739	ZY 1640 6 AR 30 05V STEEL EDGE	16,0	6	40	3,59
402740	ZY 1650 6 AR 30 05V STEEL EDGE	16,0	6	50	4,12
402742	ZY 2006 6 AR 46 05V STEEL EDGE	20,0	6	6	2,51

Ref.	Código	D mm	Ø Mango mm	T mm	€/u.
402744	ZY 2010 6 AR 60 05V STEEL EDGE	20,0	6	10	2,72
402746	ZY 2020 6 AR 30 05V STEEL EDGE	20,0	6	20	2,87
402747	ZY 2025 6 AR 60 05V STEEL EDGE	20,0	6	25	2,93
402748	ZY 2032 6 AR 30 05V STEEL EDGE	20,0	6	32	3,35
402749	ZY 2040 6 AR 60 05V STEEL EDGE	20,0	6	40	3,89
402750	ZY 2050 6 AR 30 05V STEEL EDGE	20,0	6	50	4,67
402751	ZY 2506 6 AR 80 05V STEEL EDGE	25,0	6	6	2,75
402752	ZY 2510 6 AR 30 05V STEEL EDGE	25,0	6	10	2,75
402753	ZY 2513 6 AR 30 05V STEEL EDGE	25,0	6	13	2,92
402754	ZY 2516 6 AR 60 05V STEEL EDGE	25,0	6	16	2,99
402755	ZY 2525 6 AR 30 05V STEEL EDGE	25,0	6	25	3,48
402756	ZY 2532 6 AR 60 05V STEEL EDGE	25,0	6	32	3,79
402757	ZY 2540 6 AR 30 05V STEEL EDGE	25,0	6	40	4,29
402758	ZY 3208 6 AR 30 05V STEEL EDGE	32,0	6	8	2,93
402759	ZY 3208 6 AR 60 05V STEEL EDGE	32,0	6	16	2,93
402761	ZY 3232 6 AR 46 05V STEEL EDGE	32,0	6	32	4,06
402762	ZY 3240 6 AR 24 05V STEEL EDGE	32,0	6	40	4,76
402763	ZY 3240 6 AR 46 05V STEEL EDGE	32,0	8	40	4,76
402764	ZY 4006 6 AR 46 05V STEEL EDGE	40,0	6	6	3,24
402765	ZY 4010 6 AR 30 05V STEEL EDGE	40,0	6	10	3,41
402766	ZY 4015 6 AR 60 05V STEEL EDGE	40,0	6	15	3,72
402767	ZY 4020 6 AR 24 05V STEEL EDGE	40,0	6	20	3,79
402768	ZY 4040 6 AR 46 05V STEEL EDGE	40,0	6	40	5,15
402769	ZY 4040 8 AR 24 05V STEEL EDGE	40,0	8	40	5,15
402770	ZY 5008 6 AR 30 05V STEEL EDGE	50,0	6	8	3,89
402771	ZY 5013 6 AR 30 05V STEEL EDGE	50,0	6	13	4,07

Muela esférica KU dureza O STEEL EDGE (canteado de acero)



Ref.	Código	D mm	Ø Mango mm	€/u.
402800	KU 03 3 AR 100 05V STEEL EDGE	3	3	2,45
402801	KU 03 6 AR 100 05V STEEL EDGE	3	6	2,45
402802	KU 05 3 AR 60 05V STEEL EDGE	5	3	2,45
402803	KU 05 3 AR 100 05V STEEL EDGE	5	3	2,45
402804	KU 08 3 AR 80 05V STEEL EDGE	8	3	2,51
402805	KU 08 6 AR 46 05V STEEL EDGE	8	6	2,51
402806	KU 10 3 AR 46 05V STEEL EDGE	10	3	2,61

Ref.	Código	D mm	Ø Mango mm	€/u.
402807	KU 10 3 AR 80 05V STEEL EDGE	10	3	2,61
402808	KU 13 3 AR 46 05V STEEL EDGE	13	3	2,77
402809	KU 13 3 AR 80 05V STEEL EDGE	13	3	2,77
402810	KU 16 6 AR 60 05V STEEL EDGE	16	6	3,31
402811	KU 20 6 AR 30 05V STEEL EDGE	20	6	3,54
402812	KU 25 6 AR 60 05V STEEL EDGE	25	6	4,53
402813	KU 32 6 AR 24 05V STEEL EDGE	32	6	5,43

Muela cilíndrica redondeada WR dureza O STEEL EDGE (canteado de acero)



Ref.	Código	D mm	Ø Mango mm	T mm	€/u.
402900	WR 0306 3 AR 100 05V STEEL EDGE	3	3	6	2,55
402902	WR 0510 3 AR 60 05V STEEL EDGE	5	3	10	2,55
402903	WR 0510 3 AR 100 05V STEEL EDGE	5	3	10	2,55

Ref.	Código	D mm	Ø Mango mm	T mm	€/u.
402904	WR 0816 6 AR 80 05V STEEL EDGE	8	6	16	2,51
402905	WR 1320 6 AR 46 05V STEEL EDGE	13	6	20	2,92
402906	WR 2025 6 AR 30 05V STEEL EDGE	20	6	25	3,24

Muela vaso TO dureza O STEEL EDGE (canteado de acero)

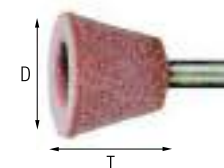

Ref.	Código	D mm	Ø Mango mm	T mm	€/u.
403100	TO 2016 6 AR 60 05V STEEL EDGE	20	6	16	3,39
403101	TO 2520 6 AR 30 05V STEEL EDGE	25	6	20	3,48
403102	TO 3225 6 AR 46 05V STEEL EDGE	32	6	25	4,31

Muela cónica KE dureza O STEEL EDGE (canteado de acero)

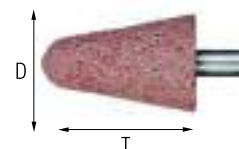

Ref.	Código	D mm	Ø Mango mm	T mm	€/u.
403300	KE 1010 3 AR 46 05V STEEL EDGE	10	3	10	2,35
403301	KE 1010 6 AR 46 05V STEEL EDGE	10	6	10	2,35
403302	KE 1025 6 AR 80 05V STEEL EDGE	10	6	25	3,25
403303	KE 1313 6 AR 46 05V STEEL EDGE	13	6	13	2,56
403304	KE 1616 6 AR 60 05V STEEL EDGE	16	6	16	2,83
403305	KE 1645 6 AR 46 05V STEEL EDGE	16	6	45	5,06
403306	KE 2020 6 AR 60 05V STEEL EDGE	20	6	20	3,35

Ref.	Código	D mm	Ø Mango mm	T mm	€/u.
403307	KE 2032 6 AR 30 05V STEEL EDGE	20	6	32	3,90
403308	KE 2040 6 AR 60 05V STEEL EDGE	20	6	40	4,54
403309	KE 2525 6 AR 30 05V STEEL EDGE	25	6	25	4,01
403310	KE 2545 6 AR 60 05V STEEL EDGE	25	6	45	4,76
403311	KE 2570 6 AR 30 05V STEEL EDGE	25	6	70	6,09
403312	KE 3232 6 AR 24 05V STEEL EDGE	32	6	32	4,76
403313	KE 3250 8 AR 24 05V STEEL EDGE	32	8	50	5,43

Muela ojival SP dureza O STEEL EDGE (canteado de acero)

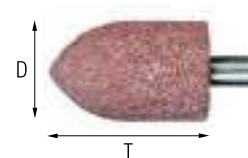

Ref.	Código	D mm	Ø Mango mm	T mm	€/u.
403200	SP 0306 3 AR 100 05V STEEL EDGE	3	3	6	2,50
403201	SP 0306 6 AR 100 05V STEEL EDGE	3	6	6	2,50
403202	SP 0510 3 AR 60 05V STEEL EDGE	5	3	10	2,55
403203	SP 0510 3 AR 100 05V STEEL EDGE	5	3	10	2,55
403204	SP 0816 6 AR 46 05V STEEL EDGE	8	6	16	2,61

Ref.	Código	D mm	Ø Mango mm	T mm	€/u.
403205	SP 0816 6 AR 80 05V STEEL EDGE	8	6	16	2,61
403206	SP 1320 6 AR 46 05V STEEL EDGE	13	6	20	2,98
403207	SP 2032 6 AR 60 05V STEEL EDGE	20	6	32	4,19
403208	SP 2050 6 AR 30 05V STEEL EDGE	20	6	50	5,15
403209	SP 2540 6 AR 30 05V STEEL EDGE	25	6	40	5,46

Muelas dureza J

La dureza J se recomienda para superficies de titanio, aleaciones de base níquel y cobalto, así como para el mecanizado de piezas de aceros templados y soldaduras de aportación.

Ventajas:

- Amolado frío por la fácil fragmentación de la mezcla de grano.
- Gran eliminación de material y muy buena vida útil.
- Arranque constante de material a través del efecto de autoafilado del grano cerámico.

Las muelas de dureza J alcanzan su mejor rendimiento a una velocidad periférica de 30 a 50 m/s. Se pueden utilizar con máquinas de eje flexible y amoladoras rectas eléctricas y neumáticas.



Muela cilíndrica ZY dureza J TOUGH (trabajos exigentes)



La dureza J se recomienda para superficies de titanio, aleaciones de base níquel y cobalto, así como para el mecanizado de piezas de aceros templados y soldaduras de aportación. Ventajas: • Amolado frío por la fácil fragmentación de la mezcla de grano. • Gran eliminación de material y muy buena vida útil. • Arranque constante de material a través del efecto de autoafilado del grano cerámico. Las muelas de dureza J alcanzan su mejor rendimiento a una velocidad periférica de 30 a 50 m/s. Se pueden utilizar con máquinas de eje flexible y amoladoras rectas eléctricas y neumáticas.

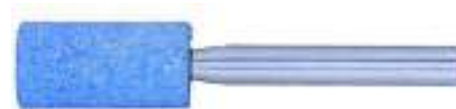

Ref.	Código	Altura mm	Ø Mango mm	Ø mm	€/ u.
403320	ZY 0306 3 AWCO 60 J5V TOUGH	6	3	3	2,45
403321	ZY 0408 3 AWCO 80 J5V TOUGH	8	3	4	2,45
403322	ZY 0408 3 AWCO 100 J5V TOUGH	8	3	4	2,45
403323	ZY 0510 3 AWCO 80 J5V TOUGH	10	3	5	2,45
403324	ZY 0510 3 AWCO 100 J5V TOUGH	10	3	5	2,45
403325	ZY 0613 3 AWCO 60 J5V TOUGH	13	3	6	2,59
403326	ZY 0613 3 AWCO 80 J5V TOUGH	13	3	6	2,59
403327	ZY 0613 3 AWCO 100 J5V TOUGH	13	3	6	2,59
403328	ZY 0816 6 AWCO 46 J5V TOUGH	16	6	8	2,49
403329	ZY 0816 6 AWCO 80 J5V TOUGH	16	6	8	2,49

Ref.	Código	Altura mm	Ø Mango mm	Ø mm	€/ u.
403330	ZY 1020 6 AWCO 46 J5V TOUGH	20	6	10	2,79
403331	ZY 1020 6 AWCO 80 J5V TOUGH	20	6	10	2,79
403332	ZY 1325 6 AWCO 46 J5V TOUGH	25	6	13	3,22
403333	ZY 1325 6 AWCO 80 J5V TOUGH	25	6	13	3,22
403334	ZY 1632 6 AWCO 46 J5V TOUGH	32	6	16	3,44
403335	ZY 2025 6 AWCO 46 J5V TOUGH	25	6	20	3,30
403336	ZY 2025 6 AWCO 60 J5V TOUGH	25	6	20	3,30
403337	ZY 2525 6 AWCO 30 J5V TOUGH	25	6	25	3,90
403338	ZY 3232 6 AWCO 24 J5V TOUGH	32	6	32	4,69

Muela cónica KE dureza J TOUGH (trabajos exigentes)



La dureza J se recomienda para superficies de titanio, aleaciones de base níquel y cobalto, así como para el mecanizado de piezas de aceros templados y soldaduras de aportación. Ventajas: • Amolado frío por la fácil fragmentación de la mezcla de grano. • Gran eliminación de material y muy buena vida útil. • Arranque constante de material a través del efecto de autoafilado del grano cerámico. Las muelas de dureza J alcanzan su mejor rendimiento a una velocidad periférica de 30 a 50 m/s. Se pueden utilizar con máquinas de eje flexible y amoladoras rectas eléctricas y neumáticas.



Ref.	Código	Altura mm	Ø Mango mm	Ø mm	€/ u.
403340	KE 1025 6 AWCO 46 J5V TOUGH	25	6	10	3,73

Ref.	Código	Altura mm	Ø Mango mm	Ø mm	€/ u.
403341	KE 1645 6 AWCO 46 J5V TOUGH	45	6	16	5,75

Muela ojival SP dureza J TOUGH (trabajos exigentes)



La dureza J se recomienda para superficies de titanio, aleaciones de base níquel y cobalto, así como para el mecanizado de piezas de aceros templados y soldaduras de aportación. Ventajas: - Amolado frío por la fácil fragmentación de la mezcla de grano. - Gran eliminación de material y muy buena vida útil. - Arranque constante de material a través del efecto de autoafilado del grano cerámico. Las muelas de dureza J alcanzan su mejor rendimiento a una velocidad periférica de 30 a 50 m/s. Se pueden utilizar con máquinas de eje flexible y amoladoras rectas eléctricas y neumáticas.



Ref.	Código	Altura mm	Ø Mango mm	Ø mm	€/ u.
403345	SP 0613 3 AWCO 80 J5V TOUGH	13	3	6	2,99
403346	SP 0816 3 AWCO 80 J5V TOUGH	16	3	8	3,02

Ref.	Código	Altura mm	Ø Mango mm	Ø mm	€/ u.
403347	SP 0816 3 AWCO 100 J5V TOUGH	16	3	8	3,02
403348	SP 1320 6 AWCO 60 J5V TOUGH	20	6	13	3,63

Abanico lijador con mango SiC



Ejecución Carburo de Silicio SiC.

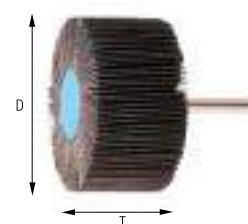

Ref.	Código	Altura mm	Ø	Ø Mango mm	r.p.m. máx.	r.p.m.	grano	€/ u.
429800	F 3010 6 SiC 60	10	30	6	18.000	12.000	60	4,28
429801	F 6030 6 SiC 60	30	60	6	12.000	6.300	60	6,87
429900	F 3010 6 SiC 80	10	30	6	18.000	12.000	80	4,28
429901	F 6030 6 SiC 80	30	60	6	12.000	6.300	80	6,87
430000	F 3010 6 SiC 120	10	30	6	18.000	12.000	120	4,28
430001	F 6030 6 SiC 120	30	60	6	12.000	6.300	120	6,87
430100	F 3010 6 SiC 150	10	30	6	18.000	12.000	150	4,28
430101	F 6030 6 SiC 150	30	60	6	12.000	6.300	150	6,87

Abanico lijador con mango INOX



Ejecución Corindón Z-COOL.

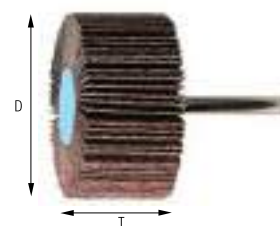

Ref.	Código	Altura mm	Ø	Ø Mango mm	r.p.m. máx.	r.p.m.	grano	€/ u.
430200	F 3020 6 60 Z-COOL	20	30	6	25.400	12.000	60	5,26
430201	F 4020 6 60 Z-COOL	20	40	6	19.100	9.600	60	6,15
430202	F 5020 6 60 Z-COOL	20	50	6	15.200	7.000	60	6,74
430203	F 6030 6 60 Z-COOL	30	60	6	12.700	6.300	60	7,89
430204	F 8050 6 60 Z-COOL	50	80	6	9.500	4.800	60	15,95
430300	F 3020 6 80 Z-COOL	20	30	6	25.400	12.000	80	5,26
430301	F 4020 6 80 Z-COOL	20	40	6	19.100	9.600	80	6,15
430302	F 5020 6 80 Z-COOL	20	50	6	15.200	7.000	80	6,74
430303	F 6030 6 80 Z-COOL	30	60	6	12.700	6.300	80	7,89
430304	F 8050 6 80 Z-COOL	50	80	6	9.500	4.800	80	15,95



Abanico lijador con mango F

Para todo tipo de lijado, desde lijado basto hasta fino. Abrasivo: Corindón A

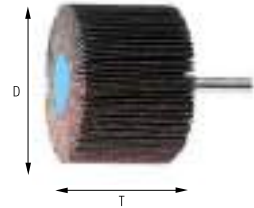

Ejecución Corindón A

Código	Grano 40	€/u.	Grano 60	€/u.	Grano 80	€/u.	Grano 120	€/u.	Ø	Altura mm	Ø Mango mm	r.p.m. máx.	r.p.m.	grano
F 1010 3			429000	4,20	429100	4,20	429200	4,20	10	10	3	75.000	38.000	80
F 1015 3			429001	4,20	429101	4,20	429201	4,20	10	15	3	75.000	38.000	80
F 1510 3			429003	4,20	429103	4,20	429203	4,20	15	10	3	50.000	25.000	80
F 1515 3			429004	4,26	429104	4,26	429204	4,26	15	15	3	50.000	25.000	80
F 1505 3			429002	4,20	429102	4,20	429202	4,20	15	5	3	50.000	25.000	80
F 2010 3							429205	3,67	20	10	3	28.000	19.000	120
F 2010 6					429106	3,67	429206	3,67	20	10	6	28.000	19.000	80
F 2510 6					429107	3,97	429207	3,97	25	10	6	23.000	15.000	80
F 2515 6					429108	4,00	429208	4,00	25	15	6	23.000	15.000	80
F 2520 6					429109	4,33	429209	4,33	25	20	6	23.000	15.000	80
F 2525 6					429110	4,48	429210	4,48	25	25	6	23.000	15.000	80
F 3010 3			429013	3,76	429113	3,76	429213	3,76	30	10	3	18.000	12.000	80
F 3010 6			429014	3,76	429114	3,76	429214	3,76	30	10	6	18.000	12.000	80
F 3015 6			429015	4,19	429115	4,19	429215	4,19	30	15	6	18.000	12.000	80
F 3030 6			429016	5,14	429116	5,14	429216	5,14	30	30	6	18.000	12.000	80
F 3005 3			429012	3,50	429112	3,50	429212	3,50	30	5	3	18.000	12.000	80
F 3005 6			429011	3,50	429111	3,50	429211	3,50	30	5	6	18.000	12.000	80
F 4010 6			429017	4,39	429117	4,39	429217	4,39	40	10	6	18.000	9.600	80
F 4015 6			429018	4,63	429118	4,63	429218	4,63	40	15	6	18.000	9.600	80
F 4020 6			429019	5,13	429119	5,13	429219	5,13	40	20	6	18.000	9.600	80
F 5010 6			429020	4,53	429120	4,53	429220	4,53	50	10	6	12.000	7.000	80
F 5015 6			429021	5,54	429121	5,54	429221	5,54	50	15	6	12.000	7.000	80
F 5020 6			429022	5,75	429122	5,75	429222	5,75	50	20	6	12.000	7.000	80
F 5030 6			429023	6,59	429123	6,59	429223	6,59	50	30	6	12.000	7.000	80
F 6015 6			429024	5,58	429124	5,58	429224	5,58	60	15	6	12.000	6.300	80
F 6020 6			429025	6,22	429125	6,22	429225	6,22	60	20	6	12.000	6.300	80
F 6030 6	428926	6,87	429026	6,87	429126	6,87	429226	6,87	60	30	6	12.000	6.300	80
F 6040 6			429027	8,18	429127	8,18	429227	8,18	60	40	6	10.000	6.300	80
F 6050 6	428928	9,46	429028	9,46	429128	9,46	429228	9,46	60	50	6	10.000	6.300	80
F 8015 6			429029	7,00	429129	7,00	429229	7,00	80	15	6	9.000	4.800	80
F 8020 6			429030	7,54	429130	7,54	429230	7,54	80	20	6	9.000	4.800	80
F 8030 6	428931	9,56	429031	9,56	429131	9,56	429231	9,56	80	30	6	9.000	4.800	80
F 8040 6			429032	11,88	429132	11,88	429232	11,88	80	40	6	7.000	4.800	80
F 8050 6	428933	13,52	429033	13,52	429133	13,52	429233	13,52	80	50	6	7.000	4.800	80

Código	Grano 150	€/u.	Grano 180	€/u.	Grano 240	€/u.	Grano 320	€/u.	Grano 400	€/u.	Ø	Altura mm	Ø Mango mm	r.p.m. máx.	r.p.m.	grano
F 1010 3	429300	4,20	429400	4,20			429600	4,20			10	10	3	75.000	38.000	150
F 1015 3	429301	4,20	429401	4,20			429601	4,20			10	15	3	75.000	38.000	150
F 1510 3	429303	4,20	429403	4,20			429603	4,20			15	10	3	50.000	25.000	150
F 1515 3	429304	4,26	429404	4,26			429604	4,26			15	15	3	50.000	25.000	150
F 1505 3	429302	4,20	429402	4,20			429602	4,20			15	5	3	50.000	25.000	150
F 2010 3	429305	3,67	429405	3,67							20	10	3	28.000	19.000	150
F 2010 6	429306	3,67	429406	3,67							20	10	6	28.000	19.000	150
F 2510 6			429407	3,97							25	10	6	23.000	15.000	180
F 2515 6	429308	4,00	429408	4,00							25	15	6	23.000	15.000	150
F 2520 6			429409	4,33							25	20	6	23.000	15.000	180
F 2525 6	429310	4,48	429410	4,48							25	25	6	23.000	15.000	150
F 3010 3	429313	3,76	429413	3,76	429513	3,76	429613	3,76			30	10	3	18.000	12.000	150
F 3010 6	429314	3,76	429414	3,76	429514	3,76	429614	3,76	429714	3,90	30	10	6	18.000	12.000	150
F 3015 6	429315	4,19	429415	4,19	429515	4,19	429615	4,19			30	15	6	18.000	12.000	150
F 3030 6	429316	5,14	429416	5,14	429516	5,14	429616	5,14			30	30	6	18.000	12.000	150
F 3005 3	429312	3,50	429412	3,50	429512	3,50	429612	3,50			30	5	3	18.000	12.000	150
F 3005 6	429311	3,50	429411	3,50	429511	3,50	429611	3,50			30	5	6	18.000	12.000	150
F 4010 6	429317	4,39	429417	4,39	429517	4,39					40	10	6	18.000	9.600	150
F 4015 6	429318	4,63	429418	4,63	429518	4,63	429618	4,63			40	15	6	18.000	9.600	150
F 4020 6	429319	5,13	429419	5,13	429519	5,13					40	20	6	18.000	9.600	150
F 5010 6	429320	4,53	429420	4,53	429520	4,53	429620	4,53			50	10	6	12.000	7.000	150
F 5015 6	429321	5,54	429421	5,54	429521	5,54	429621	5,54			50	15	6	12.000	7.000	150
F 5020 6	429322	5,75	429422	5,75							50	20	6	12.000	7.000	150
F 5030 6	429323	6,59	429423	6,59	429523	6,59	429623	6,59			50	30	6	12.000	7.000	150
F 6015 6	429324	5,58			429524	5,58	429624	5,58			60	15	6	12.000	6.300	150
F 6020 6	429325	6,22			429525	6,22	429625	6,22			60	20	6	12.000	6.300	150
F 6030 6	429326	6,87			429526	6,87	429626	6,87	429726	7,00	60	30	6	12.000	6.300	150
F 6040 6	429327	8,18			429527	8,18					60	40	6	10.000	6.300	150
F 6050 6	429328	9,46			429528	9,46	429628	9,46			60	50	6	10.000	6.300	150
F 8015 6	429329	7,00									80	15	6	9.000	4.800	150
F 8020 6	429330	7,54									80	20	6	9.000	4.800	150
F 8030 6	429331	9,56			429531	9,56	429631	9,56			80	30	6	9.000	4.800	150
F 8040 6	429332	11,88			429532	11,88					80	40	6	7.000	4.800	150
F 8050 6	429333	13,52			429533	13,52	429633	13,52			80	50	6	7.000	4.800	150



Abanico lijador de núcleo corindón A



Para todo tipo de rectificado, desde lijado basto hasta fino. Abrasivo: Corindón
 A Máquinas adecuadas: Máquinas de eje flexible y amoladoras rectas



Ref.	Código	Agujero	Ancho mm	Ø	Ø anter bridas	Perno adecuado	r.p.m. máx.	r.p.m.	grano	€ / u.
430400	FR 10030/25,4 A 40	25,4	30	100	55		9.500	5.500	40	20,84
430401	FR 10050/25,4 A 40	25,4	50	100	55		9.500	5.500	40	27,75
430402	FR 15030/25,4 A 40	25,4	30	150	79		6.300	3.500	40	29,99
430403	FR 15050/25,4 A 40	25,4	50	150	79		6.300	3.500	40	39,75
430404	FR 16530/25,4 A 40	25,4	30	165	79		5.700	3.200	40	34,03
430405	FR 16550/25,4 A 40	25,4	50	165	79		5.700	3.200	40	45,81
430500	FR 10030/25,4 A 60	25,4	30	100	55	FR/VR 12/25,4	9.500	5.500	60	20,84
430501	FR 10050/25,4 A 60	25,4	50	100	55		9.500	5.500	60	27,75
430502	FR 15030/25,4 A 60	25,4	30	150	79		6.300	3.500	60	29,99
430503	FR 15050/25,4 A 60	25,4	50	150	79		6.300	3.500	60	39,75
430504	FR 16530/25,4 A 60	25,4	30	165	79		5.700	3.200	60	34,03
430505	FR 16550/25,4 A 60	25,4	50	165	79		5.700	3.200	60	45,81
430506	FR 20030/44,0 A 60	44,0	30	200	121		4.700	2.600	60	44,36
430507	FR 20050/44,0 A 60	44,0	50	200	121	FR/VR 12/44,00	4.700	2.600	60	65,98
430508	FR 25050/44,0 A 60	44,0	50	250	121		3.800	2.100	60	89,90
430600	FR 10030/25,4 A 80	25,4	30	100	55		9.500	5.500	80	21,97
430601	FR 10050/25,4 A 80	25,4	50	100	55		9.500	5.500	80	28,11
430602	FR 15030/25,4 A 80	25,4	30	150	79	FR/VR 12/25,4	6.300	3.500	80	31,18
430603	FR 15050/25,4 A 80	25,4	50	150	79		6.300	3.500	80	46,04
430604	FR 16530/25,4 A 80	25,4	30	165	79		5.700	3.200	80	34,96
430605	FR 16550/25,4 A 80	25,4	50	165	79		5.700	3.200	80	49,09
430606	FR 20030/44,0 A 80	44,0	30	200	121		4.700	2.600	80	48,81
430607	FR 20050/44,0 A 80	44,0	50	200	121	FR/VR 12/44,00	4.700	2.600	80	68,51
430608	FR 25050/44,0 A 80	44,0	50	250	121		3.800	2.100	80	93,68
430700	FR 10030/25,4 A 120	25,4	30	100	55		9.500	5.500	120	21,97
430701	FR 10050/25,4 A 120	25,4	50	100	55		9.500	5.500	120	28,11
430702	FR 15030/25,4 A 120	25,4	30	150	79		6.300	3.500	120	31,18
430703	FR 15050/25,4 A 120	25,4	50	150	79		6.300	3.500	120	46,04
430704	FR 16530/25,4 A 120	25,4	30	165	79		5.700	3.200	120	34,96
430705	FR 16550/25,4 A 120	25,4	50	165	79		5.700	3.200	120	49,09
430802	FR 15030/25,4 A 150	25,4	30	150	79	FR/VR 12/25,4	6.300	3.500	150	34,15
430803	FR 15050/25,4 A 150	25,4	50	150	79		6.300	3.500	150	50,65
430804	FR 16530/25,4 A 150	25,4	30	165	79		5.700	3.200	150	40,18
430805	FR 16550/25,4 A 150	25,4	50	165	79		5.700	3.200	150	52,27
430903	FR 15050/25,4 A 240	25,4	50	150	79		6.300	3.500	240	55,84
430904	FR 16530/25,4 A 240	25,4	30	165	79		5.700	3.200	240	43,10
430905	FR 16550/25,4 A 240	25,4	50	165	79		5.700	3.200	240	60,58
431005	FR 16550/25,4 A 320	25,4	50	165	79		5.700	3.200	320	60,58

04



Abanico lijador con mango CO-COOL

Para lijado agresivo con máximo rendimiento de arranque en materiales duros y malos conductores del calor. Gracias a los activantes de lijado se consigue un mayor arranque de material, se evita el embizado y se logra un amolado más frío. Abrasivo: óxido cerámico CO-COOL.

Ref.	Código	Altura mm	Ø Mango mm	Ø mm	r.p.m. máx.	r.p.m.	grano	€ / u.
403350	F 3010 6 CO-COOL 40	10	6	30	25.400	12.000	40	5,46
403351	F 3015 6 CO-COOL 40	15	6	30	25.400	12.000	40	6,38
403352	F 4020 6 CO-COOL 40	20	6	40	19.100	9.600	40	7,45
403353	F 5030 6 CO-COOL 40	30	6	50	15.200	7.000	40	9,54
403354	F 6030 6 CO-COOL 40	30	6	60	12.700	6.300	40	9,98
403355	F 3010 6 CO-COOL 60	10	6	30	25.400	12.000	60	5,46
403356	F 3015 6 CO-COOL 60	15	6	30	25.400	12.000	60	6,38
403357	F 4020 6 CO-COOL 60	20	6	40	19.100	9.600	60	7,45
403358	F 5030 6 CO-COOL 60	30	6	50	15.200	7.000	60	9,54
403359	F 6030 6 CO-COOL 60	30	6	60	12.700	6.300	60	9,98
403360	F 3010 6 CO-COOL 80	10	6	30	25.400	12.000	80	5,46
403361	F 3015 6 CO-COOL 80	15	6	30	25.400	12.000	80	6,38
403362	F 4020 6 CO-COOL 80	20	6	40	19.100	9.600	80	7,45
403363	F 5030 6 CO-COOL 80	30	6	50	15.200	7.000	80	9,54
403364	F 6030 6 CO-COOL 80	30	6	60	12.700	6.300	80	9,98
403365	F 3010 6 CO-COOL 120	10	6	30	25.400	12.000	120	5,46
403366	F 3015 6 CO-COOL 120	15	6	30	25.400	12.000	120	6,38
403367	F 4020 6 CO-COOL 120	20	6	40	19.100	9.600	120	7,45
403368	F 5030 6 CO-COOL 120	30	6	50	15.200	7.000	120	9,54
403369	F 6030 6 CO-COOL 120	30	6	60	12.700	6.300	120	9,98



04

Manguito lijador GSB



Para todo tipo de lijado, desde lijado basto hasta fino. Abrasivo: Corindón A

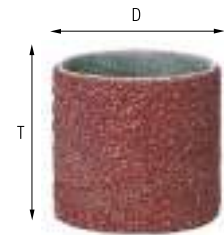

Ref.	Código	Ø mm	Altura mm	grano	€/ u.
450412	GSB 3020 A 40	30	20	40	0,69
450413	GSB 3030 A 40	30	30	40	0,93
450414	GSB 3825 A 40	38	25	40	1,19
450415	GSB 4530 A 40	45	30	40	1,26
450416	GSB 5125 A 40	51	25	40	1,39
450417	GSB 6030 A 40	60	30	40	1,58
450418	GSB 7530 A 40	75	30	40	1,86
450419	GSB 10040 A 40	100	40	40	2,73
450420	GSB 292230 A 40	29/22	30	40	2,39
450421	GSB 201463 A 40	20/14	63	40	2,82
450422	GSB 362260 A 40	36/22	60	40	3,29
450508	GSB 1530 A 50	15	30	50	0,83
450510	GSB 2220 A 50	22	20	50	0,58
450513	GSB 3030 A 50	30	30	50	0,93
450515	GSB 4530 A 50	30	45	50	1,26
450517	GSB 6030 A 50	30	60	50	1,58
450607	GSB 1510 A 60	10	15	60	0,57
450608	GSB 1530 A 60	30	15	60	0,83
450609	GSB 1925 A 60	25	19	60	0,83
450610	GSB 2220 A 60	20	22	60	0,58
450611	GSB 2525 A 60	25	25	60	0,83
450612	GSB 3020 A 60	20	30	60	0,69
450613	GSB 3030 A 60	30	30	60	0,93
450614	GSB 3825 A 60	25	38	60	1,19
450615	GSB 4530 A 60	30	45	60	1,26
450616	GSB 5125 A 60	25	51	60	1,39
450617	GSB 6030 A 60	30	60	60	1,58
450618	GSB 7530 A 60	30	75	60	1,86
450619	GSB 10040 A 60	40	100	60	2,73
450620	GSB 292230 A 60	30	29/22	60	2,39
450621	GSB 201463 A 60	63	20/14	60	2,82
450622	GSB 362260 A 60	60	36/22	60	3,29
450703	GSB 1010 A 80	10	10	80	0,58
450704	GSB 1020 A 80	20	10	80	0,85
450705	GSB 1310 A 80	10	13	80	0,57
450706	GSB 1325 A 80	25	13	80	0,78
450707	GSB 1510 A 80	10	15	80	0,57
450708	GSB 1530 A 80	30	15	80	0,83
450709	GSB 1925 A 80	25	19	80	0,83
450710	GSB 2220 A 80	20	22	80	0,58
450711	GSB 2525 A 80	25	25	80	0,83

Ref.	Código	Ø mm	Altura mm	grano	€/ u.
450712	GSB 3020 A 80	20	30	80	0,69
450713	GSB 3030 A 80	30	30	80	0,93
450714	GSB 3825 A 80	25	38	80	1,19
450715	GSB 4530 A 80	30	45	80	1,26
450716	GSB 5125 A 80	25	51	80	1,39
450717	GSB 6030 A 80	30	60	80	1,58
450718	GSB 7530 A 80	30	75	80	1,86
450719	GSB 10040 A 80	40	100	80	2,73
450720	GSB 292230 A 80	30	29/22	80	2,39
450721	GSB 201463 A 80	63	20/14	80	2,82
450722	GSB 362260 A 80	60	36/22	80	3,29
450800	GSB 0410 A 150	10	4	150	0,41
450801	GSB 0610 A 150	10	6	150	0,43
450802	GSB 0810 A 150	10	8	150	0,56
450803	GSB 1010 A 150	10	10	150	0,58
450804	GSB 1020 A 150	20	10	150	0,85
450805	GSB 1310 A 150	10	13	150	0,57
450806	GSB 1325 A 150	25	13	150	0,78
450807	GSB 1510 A 150	10	15	150	0,57
450808	GSB 1530 A 150	30	15	150	0,83
450809	GSB 1925 A 150	25	19	150	0,83
450810	GSB 2220 A 150	20	22	150	0,58
450811	GSB 2525 A 150	25	25	150	0,83
450812	GSB 3020 A 150	20	30	150	0,69
450813	GSB 3030 A 150	30	30	150	0,93
450814	GSB 3825 A 150	25	38	150	1,19
450815	GSB 4530 A 150	30	45	150	1,26
450816	GSB 5125 A 150	25	51	150	1,39
450817	GSB 6030 A 150	30	60	150	1,58
450818	GSB 7530 A 150	30	75	150	1,86
450819	GSB 10040 A 150	40	100	150	2,73
450820	GSB 292230 A 150	30	29/22	150	2,39
450821	GSB 201463 A 150	63	20/14	150	2,82
450822	GSB 362260 A 150	60	36/22	150	3,29
450904	GSB 1020 A 240	20	10	240	0,85
450908	GSB 1530 A 240	30	15	240	0,83
450910	GSB 2220 A 240	20	22	240	0,58
450913	GSB 3030 A 240	30	30	240	0,93
450915	GSB 4530 A 240	30	45	240	1,26
450921	GSB 201463 A 240	63	20/14	240	2,82

04

Manguito lijador GSB CO-COOL



Para lijado abrasivo con máxima capacidad de arranque en materiales duros, tenaces y malos conductores del calor. Gracias a los activantes de lijado se consigue un destacado arranque del material, se evita el embozado y el amolado es más frío.



Ref.	Código	Ø mm	Altura mm	grano	€/ u.
450450	GSB 3030 CO-COOL 36	30	30	36	1,34
450451	GSB 4530 CO-COOL 36	30	45	36	1,75
450452	GSB 6030 CO-COOL 36	30	60	36	2,26
450453	GSB 201463 CO-COOL 36	63	20/14	36	3,47
450454	GSB 292230 CO-COOL 36	30	29/22	36	3,01
450455	GSB 362260 CO-COOL 36	60	36/22	36	3,90
450460	GSB 1530 CO-COOL 60	30	15	60	1,14
450461	GSB 2220 CO-COOL 60	20	22	60	0,83
450462	GSB 2525 CO-COOL 60	25	25	60	1,15
450463	GSB 3030 CO-COOL 60	30	30	60	1,34
450464	GSB 4530 CO-COOL 60	30	45	60	1,75
450465	GSB 6030 CO-COOL 60	60	60	60	2,26
450466	GSB 201463 CO-COOL 60	63	20/14	60	3,47
450467	GSB 292230 CO-COOL 60	30	29/22	60	3,01
450468	GSB 362260 CO-COOL 60	60	36/22	60	3,90
450470	GSB 1530 CO-COOL 80	20	15	80	1,14
450471	GSB 2220 CO-COOL 80	30	22	80	0,83

Ref.	Código	Ø mm	Altura mm	grano	€/ u.
450472	GSB 2525 CO-COOL 80	25	25	80	1,15
450473	GSB 3030 CO-COOL 80	30	30	80	1,34
450474	GSB 4530 CO-COOL 80	30	45	80	1,75
450475	GSB 6030 CO-COOL 80	60	60	80	2,26
450476	GSB 201463 CO-COOL 80	63	20/14	80	3,47
450477	GSB 292230 CO-COOL 80	30	29/22	80	3,01
450478	GSB 362260 CO-COOL 80	60	36/22	80	3,90
450480	GSB 1530 CO-COOL 120	20	15	120	1,14
450481	GSB 2220 CO-COOL 120	30	22	120	0,83
450482	GSB 2525 CO-COOL 120	25	25	120	1,15
450483	GSB 3030 CO-COOL 120	30	30	120	1,34
450484	GSB 4530 CO-COOL 120	30	45	120	1,75
450485	GSB 6030 CO-COOL 120	60	60	120	2,26
450486	GSB 201463 CO-COOL 120	63	20/14	120	3,47
450487	GSB 292230 CO-COOL 120	30	29/22	120	3,01
450488	GSB 362260 CO-COOL 120	60	36/22	120	3,90

Dedil lijador



Ref.	Código	r.p.m. recomendadas	grano	€/ u.
451001	PC ZYA 0712 A 60	30000	60	0,81
451002	PC ZYA 1015 A 60	20000	60	0,83
451003	PC ZYA 1317 A 60	16000	60	0,85
451004	PC ZYA 1626 A 60	12000	60	1,01
451006	PC WRC 0713 A 60	30000	60	0,80
451007	PC WRC 1015 A 60	20000	60	0,83
451008	PC WRC 1317 A 60	16000	60	0,85
451009	PC WRC 1626 A 60	12000	60	1,03
451011	PC WKG 0713 A 60	30000	60	0,83
451012	PC WKG 1015 A 60	20000	60	0,83
451013	PC WKG 1317 A 60	16000	60	0,83
451014	PC WKG 1626 A 60	12000	60	1,01
451016	PC KEL 1125 A 60	20000	60	1,01
451017	PC KEL 1632 A 60	12000	60	1,09
451018	PC KEL 2140 A 60	9500	60	1,22
451100	PC ZYA 0510 A 150	40000	150	0,79
451101	PC ZYA 0712 A 150	30.000	150	0,81
451102	PC ZYA 1015 A 150	20.000	150	0,83
451103	PC ZYA 1317 A 150	16.000	150	0,85
451104	PC ZYA 1626 A 150	12.000	150	1,01
451105	PC WRC 0511 A 150	40.000	150	0,79
451106	PC WRC 0713 A 150	30.000	150	0,80
451107	PC WRC 1015 A 150	20.000	150	0,83
451108	PC WRC 1317 A 150	16.000	150	0,85
451109	PC WRC 1626 A 150	12.000	150	1,03
451110	PC WKG 0511 A 150	40.000	150	0,79
451111	PC WKG 0713 A 150	30.000	150	0,83

Ref.	Código	r.p.m. recomendadas	grano	€/ u.
451112	PC WKG 1015 A 150	20.000	150	0,83
451113	PC WKG 1317 A 150	16.000	150	0,83
451114	PC WKG 1626 A 150	12.000	150	1,01
451115	PC KEL 0515 A 150	40.000	150	0,83
451116	PC KEL 1125 A 150	20.000	150	1,01
451117	PC KEL 1632 A 150	12.000	150	1,09
451118	PC KEL 2140 A 150	9.500	150	1,22
451200	PC ZYA 0510 A 280	40.000	280	0,79
451201	PC ZYA 0712 A 280	30.000	280	0,81
451202	PC ZYA 1015 A 280	20.000	280	0,83
451203	PC ZYA 1317 A 280	16.000	280	0,85
451204	PC ZYA 1626 A 280	12.000	280	1,01
451205	PC WRC 0511 A 280	40.000	280	0,79
451206	PC WRC 0713 A 280	30.000	280	0,80
451207	PC WRC 1015 A 280	20.000	280	0,83
451208	PC WRC 1317 A 280	16.000	280	0,85
451209	PC WRC 1626 A 280	12.000	280	1,03
451210	PC WKG 0511 A 280	40.000	280	0,79
451211	PC WKG 0713 A 280	30.000	280	0,83
451212	PC WKG 1015 A 280	20.000	280	0,83
451213	PC WKG 1317 A 280	16.000	280	0,83
451214	PC WKG 1626 A 280	12.000	280	1,01
451215	PC KEL 0515 A 280	40.000	280	0,83
451216	PC KEL 1125 A 280	20.000	280	1,01
451217	PC KEL 1632 A 280	12.000	280	1,09
451218	PC KEL 2140 A 280	9.500	280	1,22

Portamanguitos



Soporte adecuado para manguitos cónicos y cilíndricos. Los portamanguitos señalados con "H" tienen una goma más dura para así poder ejercer una mayor presión de lijado. Son ideales para el mecanizado de cordones de soldadura.

Ref.	Código	Altura mm	Ø	Ø Mango mm	r.p.m. mín. GK	r.p.m. máx.	€/ u.
409100	GK 0410 M3	10	4	3	30.000	55.000	5,26
409101	GK 0410 M6	10	4	6	30.000	55.000	5,26
409102	GK 0610 M3	10	6	3	30.000	55.000	5,69
409103	GK 0610 M6	10	6	6	30.000	55.000	5,69
409104	GK 0810 M3	10	8	3	30.000	55.000	6,15
409105	GK 0810 M6	10	8	6	30.000	55.000	6,15
409106	GK 1010 M6	10	10	6	30.000	44.000	9,67
409107	GK 1020 M6	20	10	6	30.000	44.000	14,76
409108	GK 1310 M6	10	13	6	30.000	44.000	9,67
409109	GK 1325 M6	25	13	6	30.000	44.000	14,76
409110	GK 1510 M6	10	15	6	26.000	36.000	9,67
409111	GK 1530 M6	30	15	6	26.000	36.000	14,76
409112	GK 1925 M6	25	19	6	20.000	30.000	15,56
409114	GK 2220 M6	20	22	6	18.000	26.000	12,22
409115	GK 2525 M6	25	25	6	16.000	22.900	16,59
409116	GK 3020 M6	20	30	6	13.000	19.100	13,37
409117	GK 3030 M6	30	30	6	13.000	19.100	14,76
409118	GK 3030 M6.H	30	30	6	13.000	19.100	14,76
409119	GK 3825 M6	25	38	6	10.000	15.900	17,00
409120	GK 4530 M6	30	45	6	8.500	12.700	16,94
409121	GK 4530 M6.H	30	45	6	8.500	12.700	16,94
409122	GK 5125 M6	25	51	6	7.500	11.200	20,35
409123	GK 6030 M6	30	60	6	6.500	9.500	21,76
409124	GK 6030 M8	30	60	8	6.500	9.500	21,76
409125	GK 7530 M8	30	75	8	5.000	7.600	24,38
409126	GK 10040 M8	40	100	8	4.000	5.700	31,15
409127	GK 292230 M6	30	29/22	6	13.000	19.100	12,55
409128	GK 201463 M6	63	20/14	6	19.000	26.000	19,11
409129	GK 362260 M6	60	36/22	6	10.000	15.900	19,90



04

Canuto lijador



Manguitos POLICAP de forma cónica. Abrasivo: Corindón A Código de colores según el tamaño de grano: 60 = marrón 150 = negro 280 = marrón rojizo

Ref.	Código	r.p.m. recomendadas	Granos suministrables	€/ u.
451300	PCH 070585 LA 60	12000	60	2,36
451301	PCH 141185 LA 60	12000	60	2,65
451302	PCH 201685 LA 60	12000	60	2,81
451303	PCH 242185 LA 60	12000	60	2,92
451304	PCH 201565 LA 60	18500	60	3,69
451305	PCH 362265 LA 60	12.000	60	3,83
451400	PCH 070585 LA 150	12.000	150	2,36
451401	PCH 141185 LA 150	12.000	150	2,65
451402	PCH 201685 LA 150	12.000	150	2,81
451403	PCH 242185 LA 150	12.000	150	2,92
451404	PCH 201565 LA 150	18.500	150	3,69
451500	PCH 070585 LA 280	12.000	280	2,36



Portacanutos



Forma cónica redonda KEL [anteriormente forma L]. Los canutos se ajustan perfectamente al portacanutos gracias a la perfecta adherencia de la goma.

Ref.	Código	Ø Mango mm	Ø x altura cabeza mm	r.p.m. máx.	r.p.m. recomendadas	€/ u.
409300	PCT KEL 0585/6	6	5 x 85	20.000	12.000	13,24
409301	PCT KEL 1185/6	6	11 x 85	15.000	12.000	13,24
409302	PCT KEL 1685/6	6	16 x 85	13.000	12.000	13,24
409303	PCT KEL 2185/6	6	21 x 85	12.000	12.000	13,24



Portadeditales



Ref.	Código	Ø Mango mm	Ø x altura mm	r.p.m. máx.	€/ u.
409500	PCT ZYA 0510/3	3	5 x 10	95.000	6,27
409501	PCT ZYA 0712/3	3	7 x 12	65.000	6,75
409502	PCT ZYA 1015/3	3	10 x 15	45.000	6,85
409503	PCT ZYA 1317/6	6	13 x 17	35.000	6,82
409504	PCT ZYA 1626/6	6	16 x 26	30.000	7,01
409505	PCT WRC 0511/3	3	5 x 11	95.000	6,27
409506	PCT WRC 0713/3	3	7 x 13	65.000	6,75
409507	PCT WRC 1015/3	3	10 x 15	45.000	6,85
409508	PCT WRC 1317/6	6	13 x 17	35.000	6,82
409509	PCT WRC 1626/6	6	16 x 26	30.000	7,01
409510	PCT WKG 0511/3	3	5 x 11	95.000	6,17
409511	PCT WKG 0713/3	3	7 x 13	65.000	6,75
409512	PCT WKG 1015/3	3	10 x 15	45.000	6,85
409513	PCT WKG 1317/6	6	13 x 17	35.000	6,82
409514	PCT WKG 1626/6	6	16 x 26	30.000	7,01
409515	PCT KEL 0515/6	6	5 x 15	95.000	8,32
409516	PCT KEL 1125/6	6	11 x 25	40.000	8,65
409517	PCT KEL 1632/6	6	16 x 32	30.000	8,84
409518	PCT KEL 2140/6	6	21 x 40	20.000	12,77



Abanico para máquinas angulares



Herramienta para utilizar con amoladoras angulares en trabajos de montaje. Para todo tipo de rectificado, desde lijado basto hasta fino. Se puede montar directamente en la amoladora angular sin necesidad de otro medio de sujeción. Abrasivo: Corindón A Para obtener un rendimiento óptimo, utilizar a una velocidad de corte recomendada de 40-50m/s. Máquinas adecuadas: Amoladoras angulares y amoladora angular de batería

Ref.	Código	Ø x espesor mm	r.p.m. máx.	Rosca	grano	€/ u.
431500	FR-WS 11520 A 40 M14	115 x 20	13.300	M14	40	20,90
431501	FR-WS 12520 A 40 M14	125 x 20	12.200	M14	40	22,04
431600	FR-WS 11520 A 60 M14	115 x 20	13.300	M14	60	20,90
431601	FR-WS 12520 A 60 M14	125 x 20	12.200	M14	60	22,04
431700	FR-WS 11520 A 80 M14	115 x 20	13.300	M14	80	22,12
431701	FR-WS 12520 A 80 M14	125 x 20	12.200	M14	80	23,36
431800	FR-WS 11520 A 120 M14	115 x 20	13.300	M14	120	22,12
431801	FR-WS 12520 A 120 M14	125 x 20	12.200	M14	120	23,36



Rodillo de lija



Utilizables para todo tipo de mecanizados de superficies medianas y grandes de metales, p. ej., trabajos de afinado en grandes radios en la fabricación de herramientas y moldes, para lograr acabados homogéneos en grandes superficies y contornos en el trabajo manual (matizado a franjas). Apropriados para todos los sistemas de chaveta de ajuste corrientes. Abrasivo: Corindón A Recomendaciones de uso: Para obtener un rendimiento óptimo, utilizar a una velocidad de corte recomendada de 15-30m/s. Máquinas adecuadas: Amoladora para rodillos

Ref.	Código	Ø x espesor mm	r.p.m. máx.	grano	€/ u.
431900	FR-W 100100 A 40	100 x 100	3.700	40	53,00
432000	FR-W 100100 A 60	100 x 100	3.700	60	59,91
432100	FR-W 100100 A 80	100 x 100	3.700	80	61,78
432200	FR-W 100100 A 120	100 x 100	3.700	120	63,33
432300	FR-W 100100 A 150	100 x 100	3.700	150	66,42
432400	FR-W 100100 A 180	100 x 100	3.700	180	68,50



Abanico sistema POLIFLAP



El abanico lijador POLIFLAP se compone de un cuerpo soporte con un mango y láminas de goma, entre las que se colocan las láminas lijadoras. La combinación y disposición de las láminas lijadoras y de goma confiere a la herramienta una gran flexibilidad. Por favor, pedir por separado: Cuerpo soporte: PFL 17060/12 Láminas de goma: PFL-GL



Ref.	Código	Dimensiones mm	€/ u.
432502	POLIFLAP PFL-SLA 60	60 x 75	1,48
432602	POLIFLAP PFL-SLA 80	60 x 75	1,35
432702	POLIFLAP PFL-SLA 100	60 x 75	1,35
432802	POLIFLAP PFL-SLA 150	60 x 75	1,22
432902	POLIFLAP PFL-SLA 180	60 x 75	1,22
433002	POLIFLAP PFL-SLA 220	60 x 75	1,22
433102	POLIFLAP PFL-SLA 320	60 x 75	1,22

Abanico de vellón con mango POLINOX PNL



El vellón está dispuesto radialmente. Gracias a la disposición compacta de estas láminas se consigue una larga vida útil. La herramienta se utiliza principalmente para el trabajo sobre superficies. Abrasivo: Corindón A Máquinas adecuadas: Máquinas de eje flexible y amoladoras rectas



Ref.	Código	Altura mm	Ø	Ø Mango mm	r.p.m. máx.	r.p.m.	grano	€/ u.
433200	PNL 4020/6 A 100	20	40	6	15.000	7.500	100	9,42
433201	PNL 5030/6 A 100	30	50	6	12.000	6.000	100	11,34
433202	PNL 6050/6 A 100	50	60	6	10.000	5.000	100	12,79
433300	PNL 4020/6 A 180	20	40	6	15.000	7.500	180	9,42
433301	PNL 5030/6 A 180	30	50	6	12.000	6.000	180	11,34
433302	PNL 6050/6 A 180	50	60	6	10.000	5.000	180	12,79
433303	PNL 8050/6 A 180	50	80	6	7.500	4.000	180	16,10
433400	PNL 4020/6 A 280	20	40	6	15.000	7.500	280	9,42
433401	PNL 5030/6 A 280	30	50	6	12.000	6.000	280	11,34
433402	PNL 6050/6 A 280	50	60	6	10.000	5.000	280	12,79
433403	PNL 8050/6 A 280	50	80	6	7.500	4.000	280	16,10

Abanico de vellón con mango POLINOX PNZ



El vellón está dispuesto radialmente. Gracias a la disposición compacta de estas láminas se consigue una larga vida útil. La herramienta se utiliza principalmente para el trabajo sobre superficies. Abrasivo: Corindón A Máquinas adecuadas: Máquinas de eje flexible y amoladoras rectas



Ref.	Código	Altura mm	Ø	Ø Mango mm	r.p.m. máx.	r.p.m.	grano	€/ u.
433500	PNZ 4020/6 A 100	20	40	6	15.000	7.500	100	12,42
433504	PNZ 6025/6 A 100	25	60	6	10.000	5.000	100	13,01
433505	PNZ 8025/6 A 100	25	80	6	8.000	4.000	100	14,57
433501	PNZ 6050/6 A 100	50	60	6	10.000	5.000	100	17,80
433502	PNZ 8050/6 A 100	50	80	6	7.500	4.000	100	19,08
433503	PNZ 10050/6 A 100	50	100	6	6.000	3.000	100	29,93
433600	PNZ 4020/6 A 180	20	40	6	15.000	7.500	180	12,42
433604	PNZ 6025/6 A 180	25	60	6	10.000	5.000	180	13,01
433605	PNZ 8025/6 A 180	25	80	6	8.000	4.000	180	14,57
433601	PNZ 6050/6 A 180	50	60	6	10.000	5.000	180	17,80
433602	PNZ 8050/6 A 180	50	80	6	7.500	4.000	180	19,08
433603	PNZ 10050/6 A 180	50	100	6	6.000	3.000	180	29,93

Abanico de vellón de núcleo POLINOX PNL



El vellón de amolar está dispuesto radialmente. Gracias a la disposición compacta de estas láminas se consigue una larga vida útil. La herramienta se utiliza principalmente para el mecanizado de grandes superficies. Abrasivo: Corindón A Máquinas adecuadas: Máquinas de eje flexible, amoladoras rectas y amoladoras de banco

Ref.	Código	Ancho mm	Ø	Perno adecuado	r.p.m. máx.	r.p.m.	grano	€/ u.
433700	PNL 15050/25,4 A 100	50	150	FR/VR 12/25,4	4.000	2.000	100	62,50
433701	PNL 20050/44 A 100	50	200	FR/VR 12/44,0	3.000	1.500	100	82,13
433800	PNL 15050/25,4 A 180	50	150	FR/VR 12/25,4	4.000	2.000	180	68,67
433801	PNL 20050/44 A 180	50	200	FR/VR 12/44,0	3.000	1.500	180	89,35
433900	PNL 15050/25,4 A 280	50	150	FR/VR 12/25,4	4.000	2.000	280	70,04
433901	PNL 20050/44 A 280	50	200	FR/VR 12/44,0	3.000	1.500	280	92,61



Abanico de vellón de núcleo POLINOX PNZ



Las láminas de vellón de amolar están dispuestas radialmente e intercaladas con láminas de lija. Con esta disposición laminar se logra un mayor arranque de material y un acabado más basto. La herramienta se utiliza principalmente para el mecanizado de grandes superficies. Abrasivo: Corindón A Máquinas adecuadas: Máquinas de eje flexible, amoladoras rectas y amoladoras de banco

Ref.	Código	Ancho mm	Ø	Perno adecuado	r.p.m. máx.	r.p.m.	grano	€/ u.
434000	PNZ 15050/25,4 A 100	50	150	FR/VR 12/25,4	4.000	2.000	100	76,81
434001	PNZ 20050/44 A 100	50	200	FR/VR 12/44,0	3.000	1.500	100	94,29
434100	PNZ 15050/25,4 A 180	50	150	FR/VR 12/25,4	4.000	2.000	180	76,81
434101	PNZ 20050/44 A 180	50	200	FR/VR 12/44,0	3.000	1.500	180	94,29



Abanico de vellón de núcleo POLINOX PNL con rosca



El vellón de amolar está dispuesto radialmente. Gracias a la disposición compacta de estas láminas se consigue una larga vida útil. La herramienta ha sido diseñada para el mecanizado de superficies de tamaño mediano en amoladoras angulares y amoladoras para soldadura en ángulo con regulación electrónica de revoluciones, y se puede montar directamente en el husillo de la máquina. Abrasivo: Corindón A Máquinas adecuadas: Amoladoras angulares y amoladora angular de batería

Ref.	Código	Altura mm	Ø mm	r.p.m. máx.	r.p.m. recomendadas	Rosca	grano	€/ u.
403370	PNL 10050 M14 A 100	50	100	6.000	3.000	M14	100	25,28
403371	PNL 10050 M14 A 180	50	100	6.000	3.000	M14	180	25,28
403372	PNL 10050 M14 A 280	50	100	6.000	3.000	M14	280	25,28
403373	PNL 10050 5/8-11 A 100	50	100	6.000	3.000	5/8-11	100	25,28
403374	PNL 10050 5/8-11 A 180	50	100	6.000	3.000	5/8-11	180	25,28
403375	PNL 10050 5/8-11 A 280	50	100	6.000	3.000	5/8-11	280	25,28



Abanico de vellón de núcleo POLINOX PNZ con rosca



Las láminas de vellón de amolar están dispuestas radialmente e intercaladas con láminas de lija. Con esta disposición laminar se logra un mayor arranque de material y un acabado más basto. La herramienta ha sido diseñada para el mecanizado de superficies de tamaño mediano en amoladoras angulares y amoladoras para soldadura en ángulo con regulación electrónica de revoluciones, y se puede montar directamente en el husillo de la máquina. Abrasivo: Corindón A Máquinas adecuadas: Amoladoras angulares y amoladora angular de batería

Ref.	Código	Altura mm	Ø mm	r.p.m. máx.	r.p.m. recomendadas	Rosca	grano	€/ u.
403380	PNZ 10050 M14 A 100	50	100	6.000	3.000	M14	100	28,90
403381	PNZ 10050 5/8-11 A 100	50	100	6.000	3.000	5/8-11	100	28,90
403382	PNZ 10050 M14 A 180	50	100	6.000	3.000	M14	180	28,90
403383	PNZ 10050 5/8-11 A 180	50	100	6.000	3.000	5/8-11	180	28,90



Abanico de vellón de núcleo POLINOX PNG con rosca



Láminas de vellón de amolar muy onduladas dispuestas axialmente alrededor de un núcleo. Esta estructura ondulada del vellón de amolar permite un acabado de superficie matizado y sin marcas de transición visibles. La herramienta ha sido diseñada para el mecanizado de superficies de tamaño mediano en amoladoras angulares y amoladoras para soldadura en ángulo con regulación electrónica de revoluciones, y se puede montar directamente en el husillo de la máquina. Abrasivo: Corindón A Máquinas adecuadas: Amoladoras angulares y amoladora angular de batería

Ref.	Código	Altura mm	Ø mm	r.p.m. máx.	r.p.m. recomendadas	Rosca	grano	€/ u.
403385	PNG 10050 M14 A 100	50	100	6.000	3.000	M14	100	41,04
403386	PNG 10050 5/8-11 A 100	50	100	6.000	3.000	5/8-11	100	41,04
403387	PNG 12550 M14 A 100	50	125	3.800	2.300	M14	100	53,12
403388	PNG 12550 5/8-11 A 100	50	125	3.800	2.300	5/8-11	100	53,12
403389	PNG 10050 M14 A 180	50	100	6.000	3.000	M14	180	41,04
403390	PNG 10050 5/8-11 A 180	50	100	6.000	3.000	5/8-11	180	41,04
403391	PNG 12550 M14 A 180	50	125	3.800	2.300	M14	180	53,12
403392	PNG 12550 5/8-11 A 180	50	125	3.800	2.300	5/8-11	180	53,12
403393	PNG 10050 M14 A 280	50	100	6.000	3.000	M14	280	41,04
403394	PNG 10050 5/8-11 A 280	50	100	6.000	3.000	5/8-11	280	41,04
403395	PNG 12550 M14 A 280	50	125	3.800	2.300	M14	280	53,12
403396	PNG 12550 5/8-11 A 280	50	125	3.800	2.300	5/8-11	280	53,12



Rodillo de vellón y lija



El vellón de amolar está dispuesto radialmente. Además está dispuesto tejido de lija entre las láminas. La disposición laminar garantiza mayor arranque de material y que la superficie tenga un acabado más basto. Abrasivo: Corindón A

Ref.	Código	Ø x espesor mm	r.p.m. máx.	grano	€/ u.
434200	PNZ-W 100100 A 60 G	100 x 100	5.000	G/60	54,44
434300	PNZ-W 100100 A 80 M	100 x 100	5.000	M/80	58,35
434400	PNZ-W 100100 A 120 F	100 x 100	5.000	F/120	62,26



Rodillo de vellón



El vellón de amolar está dispuesto radialmente. Además está dispuesto tejido de lija entre las láminas. La disposición laminar garantiza mayor arranque de material y que la superficie tenga un acabado más basto. Abrasivo: Corindón A

Ref.	Código	Ø x espesor mm	r.p.m. máx.	grano	€/ u.
434500	PNL-W 100100 A 100	100 x 100	5.000	100	54,44
434600	PNL-W 100100 A 180	100 x 100	5.000	180	58,35
434700	PNL-W 100100 A 280	100 x 100	5.000	280	62,26



Banda de vellón



Adecuadas para todo tipo de trabajos de mecanizado de superficies, por ejemplo, en construcciones de tubos de metal, para eliminar marcas de rectificado previo, eliminar óxido y trabajos de desbarbado ligeros. Se obtienen superficies matizadas y satinadas. Para obtener un rendimiento óptimo, utilizar a una velocidad de corte recomendada de 5-15 m/s. Abrasivo: Corindón A
Tamaños de grano POLIVLIES disponibles: 100 G = basto (marrón claro); 180 M = medio (marrón rojizo); 240 F = fino (azul)



Ref.	Código	Anchura x longitud mm	grano	€/ u.
435100	VB 6/305 A100 G	6 x 305	100 Basto	4,56
435101	VB 6/520 A100 G	6 x 520	100 Basto	6,41
435102	VB 9/305 A100 G	9 x 305	100 Basto	5,85
435103	VB 12/305 A100 G	12 x 305	100 Basto	7,33
435104	VB 12/520 A100 G	12 x 520	100 Basto	9,66
435105	VB 16/520 A100 G	16 x 520	100 Basto	11,82
435106	VB 20/520 A100 G	20 x 520	100 Basto	13,63
435107	VB 30/533 A100 G	30 x 533	100 Basto	15,30
435108	VB 35/450 A100 G	35 x 450	100 Basto	16,14
435109	VB 50/450 A100 G	50 x 450	100 Basto	20,50
435200	VB 6/305 A180 M	6 x 305	180 Medio	4,37
435201	VB 6/520 A180 M	6 x 520	180 Medio	6,22
435202	VB 9/305 A180 M	9 x 305	180 Medio	5,61
435203	VB 12/305 A180 M	12 x 305	180 Medio	7,11
435204	VB 12/520 A180 M	12 x 520	180 Medio	9,25

Ref.	Código	Anchura x longitud mm	grano	€/ u.
435205	VB 16/520 A180 M	16 x 520	180 Medio	11,30
435206	VB 20/520 A180 M	20 x 520	180 Medio	13,08
435207	VB 30/533 A180 M	30 x 533	180 Medio	14,80
435208	VB 35/450 A180 M	35 x 450	180 Medio	13,63
435209	VB 50/450 A180 M	50 x 450	180 Medio	18,01
435300	VB 6/305 A240 F	6 x 305	240 Fino	4,23
435301	VB 6/520 A240 F	6 x 520	240 Fino	6,04
435302	VB 9/305 A240 F	9 x 305	240 Fino	5,43
435303	VB 12/305 A240 F	12 x 305	240 Fino	6,86
435304	VB 12/520 A240 F	12 x 520	240 Fino	8,86
435305	VB 16/520 A240 F	16 x 520	240 Fino	10,85
435306	VB 20/520 A240 F	20 x 520	240 Fino	12,56
435307	VB 30/533 A240 F	30 x 533	240 Fino	14,27
435308	VB 35/450 A240 F	35 x 450	240 Fino	13,08
435309	VB 50/450 A240 F	50 x 450	240 Fino	17,64

Disco compacto de amolar POLINOX PNER



Se utilizan en amoladoras angulares para rectificado frontal. Tienen soporte de fibra de vidrio y son especialmente adecuados para mecanizado de grandes superficies de acero fino (INOX).



Ref.	Código	Ejecución densidad vellón	Grano	Ø Agujero mm	Ø x espesor mm	r.p.m.	€/ u.
425000	PNER-W 115-22 SIC F	Blanda	Fino	22,23	115 x 13	6.000	32,80
425001	PNER-W 125-22 SIC F	Blanda	Fino	22,23	125 x 13	5.400	38,05
425002	PNER-MW 115-22 SIC F	Semiblanda	Fino	22,23	115 x 13	6.000	33,85
425003	PNER-MW 125-22 SIC F	Semiblanda	Fino	22,23	125 x 13	5.400	42,24
425004	PNER-MH 115-22 SIC F	Semidura	Fino	22,23	115 x 13	6.000	35,60
425005	PNER-MH 125-22 SIC F	Semidura	Fino	22,23	125 x 13	5.400	44,61

Pliego de vellón



Adecuadas para el lijado muy fino de superficies pequeñas a grandes y contornos, así como trabajos de limpieza manual en metales y superficies pintadas. Se obtienen superficies matizadas y satinadas. Estructura muy abierta. Adaptación óptima a los contornos gracias a su alta flexibilidad. Llegan a puntos de difícil acceso. Se pueden usar para el lijado seco y húmedo. Abrasivo: Corindón A o Carburo de silicio SiC



Ref.	Código	Anchura x longitud mm	grano	€/ u.
435400	PVSK 150 A 80	154 x 224	80 Muy Basto	2,88
435500	PVSK 150 A 100	154 x 224	100 Basto	2,42
435600	PVSK 150 A 180	154 x 224	180 Medio	2,24
435700	PVSK 150 A 280	154 x 224	280 Fino	2,24
435800	PVSK 150 C 400	154 x 224	400 Muy Fino	2,24

Rollo de vellón



Adecuadas para trabajos de acabado fino en superficies pequeñas a grandes y contornos, así como trabajos de limpieza en metales y superficies pintadas con lijado manual. Se pueden lograr superficies matizadas y satinadas. Estructura muy abierta. Adaptación óptima a los contornos gracias a su alta flexibilidad. Llegan a puntos de difícil acceso. Se pueden usar para el lijado seco y húmedo. Abrasivo: Corindón A



Ref.	Código	Anchura x longitud mm	grano	€/ u.
435900	VBR 100 A 100	100 x 10.000	100 Basto	85,40
436000	VBR 100 A 180	100 x 10.000	180 Medio	78,43
436100	VBR 100 A 280	100 x 10.000	240 Fino	69,75

Rueda de vellón COMBICLICK® PNER



• El sistema de fijación rápida y refrigeración patentado por PFERD resulta ideal para discos de lija, herramientas de vellón y de fieltro. • El sistema COMBICLICK® consta de un plato de apoyo especialmente diseñado y un sistema especial de fijación en la trasera de los discos. • Gracias al plato soporte las herramientas COMBICLICK® se pueden utilizar con amoladoras angulares convencionales. • La geometría especial de las ranuras de refrigeración garantiza el paso de gran cantidad de aire, de manera que se reducen la carga térmica del abrasivo y la de la herramienta. • Un buen sistema de fijación, un soporte robusto para asegurar la herramienta y un óptimo sistema de refrigeración logran: - Reducir hasta un 30 % la temperatura de la pieza de trabajo. - Aumentar hasta un 25 % más el arranque de material.



Ref.	Código	Ejecución	Grano	Ø mm	r.p.m. máx.	r.p.m.	€/ u.
425290	CC-PNER W 115 SIC F	Blanda	Fino	115	8.350	5.000	17,36
425291	CC-PNER MW 115 SIC F	Semiblanda	Fino	115	8.350	5.000	19,30
425292	CC-PNER MH 115 SIC F	Semidura	Fino	115	8.350	5.000	20,37
425293	CC-PNER H 115 A F	Dura	Fino	115	8.350	5.000	22,37
425294	CC-PNER W 125 SIC F	Blanda	Fino	125	7.650	4.500	21,57
425295	CC-PNER MW 125 SIC F	Semiblanda	Fino	125	7.650	4.500	24,20
425296	CC-PNER MH 125 SIC F	Semidura	Fino	125	7.650	4.500	25,42
425297	CC-PNER H 125 A F	Dura	Fino	125	7.650	4.500	28,06

Rodaja de vellón COMBICLICK® VRH y VRW



• El sistema de fijación rápida y refrigeración patentado por PFERD resulta ideal para discos de lija, herramientas de vellón y de fieltro. • El sistema COMBICLICK® consta de un plato de apoyo especialmente diseñado y un sistema especial de fijación en la trasera de los discos. • Gracias al plato soporte las herramientas COMBICLICK® se pueden utilizar con amoladoras angulares convencionales. • La geometría especial de las ranuras de refrigeración garantiza el paso de gran cantidad de aire, de manera que se reducen la carga térmica del abrasivo y la de la herramienta. • Un buen sistema de fijación, un soporte robusto para asegurar la herramienta y un óptimo sistema de refrigeración logran: - Reducir hasta un 30 % la temperatura de la pieza de trabajo. - Aumentar hasta un 25 % más el arranque de material.



Ref.	Código	Altura mm	r.p.m. máx.	r.p.m. recomendadas	Rosca	grano	€/ u.
425310	CC-VRH 115 A 100 G	Dura	10.500	3.300	115	100	6,89
425311	CC-VRH 125 A 100 G	Dura	9.650	3.100	125	100	7,70
425312	CC-VRW 115 A 100	Blanda	10.500	3.300	115	100	5,42
425313	CC-VRW 125 A 100	Blanda	9.650	3.100	125	100	6,08
425315	CC-VRH 115 A 180 M	Dura	10.500	3.300	115	180	6,39
425316	CC-VRH 125 A 180 M	Dura	9.650	3.100	125	180	7,36

Ref.	Código	Altura mm	r.p.m. máx.	r.p.m. recomendadas	Rosca	grano	€/ u.
425317	CC-VRW 115 A 180	Blanda	10.500	3.300	115	180	5,23
425318	CC-VRW 125 A 180	Blanda	9.650	3.100	125	180	5,82
425320	CC-VRH 115 A 240 F	Dura	10.500	3.300	115	240	6,12
425321	CC-VRH 125 A 240 F	Dura	9.650	3.100	125	240	7,06
425330	CC-VRW 115 A 280	Blanda	10.500	3.300	115	280	5,12
425331	CC-VRW 125 A 280	Blanda	9.650	3.100	125	280	5,68



Muela de fieltro

La forma cilíndrica ZYA se utiliza fundamentalmente con el contorno de la herramienta. La ejecución con agujero frontal (ST-BO) es especialmente adecuada para el trabajo frontal. La forma cónica en punta SPK se utiliza fundamentalmente para el mecanizado de radios y contornos. La forma cilíndrica redonda WRC se utiliza mayormente para el mecanizado de pequeños contornos cóncavos. La forma cónica KEL se utiliza fundamentalmente para el mecanizado de radios. La forma de gota TRE se utiliza fundamentalmente para el mecanizado de pequeños radios. La forma de ángulo WKN se utiliza fundamentalmente para el mecanizado de ángulos interiores.

Ref.	Código	Longitud Cabeza	Longitud Mango	Ø Cabeza	Ø Mango mm	r.p.m.	€ / u.
405500	FK ZYA 0610/3 M	10	40	6	3	16-32.000	3,78
405501	FK ZYA 0810/3 M	10	40	8	3	12-24.000	3,86
405502	FK ZYA 1015/3 M	15	40	10	3	10-20.000	4,25
405503	FK ZYA 1015/6 M	15	40	10	6	10-20.000	4,39
405504	FK ZYA 1520/6 M ST-BO	20	40	15	6	6-12.000	6,42
405505	FK ZYA 2025/6 M ST-BO	25	40	20	6	5-10.000	7,89
405506	FK ZYA 2530/6 M ST-BO	30	40	25	6	4-8.000	9,71
405507	FK SPK 0812/3 M	12	40	8	3	12-24.000	3,94
405508	FK SPK 1018/3 M	18	40	10	3	10-20.000	4,51
405509	FK SPK 1218/3 M	18	40	12	3	6-12.000	4,73
405510	FK SPK 1018/6 M	18	40	10	6	5-10.000	4,51
405511	FK SPK 1520/6 M	20	40	15	6	4-8.000	5,62
405512	FK SPK 1530/6 M	30	40	15	6	6-12.000	6,42
405513	FK SPK 2025/6 M	25	40	20	6	5-10.000	7,49
405514	FK WRC 0812/3 M	12	40	8	3	12-24.000	3,94
405515	FK WRC 1014/3 M	14	40	10	3	10-20.000	4,51
405516	FK WRC 1520/6 M	20	40	15	6	6-12.000	5,62
405517	FK WRC 2025/6 M	25	40	20	6	5-10.000	7,26
405518	FK WRC 2530/6 M	30	40	25	6	4-8.000	9,14
405519	FK KEL 1520/6 M	20	40	15	6	6-12.000	5,59
405520	FK KEL 2025/6 M	25	40	20	6	5-10.000	7,95
405521	FK KEL 2530/6 M	30	40	25	6	4-8.000	9,07
405522	FK KEL 3035/6 M	35	40	30	6	3-6.000	12,32
405523	FK TRE 1014/6 M	14	40	10	6	10-20.000	4,64
405524	FK WKN 2016/6 M	16	40	20	6	5-10.000	7,83



Muela de fieltro con inclusión metálica



La forma cilíndrica ZYA se utiliza fundamentalmente con el contorno de la herramienta. La ejecución con agujero frontal (ST-BO) es especialmente adecuada para el trabajo frontal. Las muelas de fieltro con inclusión metálica (MS) para un mayor arranque de material en el prepulido se deben utilizar con pastas de pulir de diamante.

Ref.	Código	Longitud Cabeza	Longitud Mango	Ø Cabeza	Ø Mango mm	r.p.m.	€ / u.
405600	FK ZYA 1015/3 MS	15	40	10	3	10-20.000	7,32
405601	FK ZYA 1520/6 MS ST-BO	20	40	15	6	6-12.000	11,86
405602	FK ZYA 2025/6 MS ST-BO	25	40	20	6	5-10.000	19,27
405603	FK ZYA 2530/6 MS ST-BO	30	40	25	6	4-8.000	27,56



Disco de fieltro



Los discos de fieltro normalmente se utilizan para pulir con el contorno de la herramienta. Máquinas adecuadas: Máquinas de eje flexible y amoladoras rectas.

Ref.	Código	Ancho mm	Ø	Ø Agujero mm	Perno adecuado	r.p.m.	€ / u.
405700	FK SC 3007/6 M	7	30	6	6/6 3-10	3.000-6.000	7,62
405701	FK SC 4509/6 M	9	45	6	6/6 3-10	2.000-4.000	9,20
405702	FK SC 6010/6 M	10	60	6	6/6 3-10	1.500-3.000	7,99
405703	FK SC 8010/10 M	10	80	10	8/10 6-20	1.000-2.000	11,92
405704	FK SC 10020/10 M	20	100	10	8/10 6-20	900-1.800	34,87
405705	FK SC 12520/20 M	20	125	20	12/20 10-50 MK 1/20 10-50	750-1.500	48,02
405706	FK SC 15025/20 M	25	150	20	12/20 10-50 MK 1/20 10-50	600-1.200	72,19
405707	FK SC 20030/20 M	30	200	20	12/20 10-50 MK 1/20 10-50	500-1.000	147,05



Disco de paño



Los discos de paño se emplean con pastas de pulir para el prepulido y el pulido espejo. Para conseguir superficies muy lisas se han de emplear varias o incluso todas las ejecuciones una tras otra. Los discos de paño se suministran en tres ejecuciones diferentes: Aplicaciones: - Prepulido de acero e INOX: discos de paño ST o TH con pasta de pulir PP 1 VP STEELOX. - Prepulido de aluminio y latón: discos de paño ST o TH con pasta de pulir PP 2 VP ALU. - Prepulido de metales no férricos: discos de paño ST o TH con pasta de pulir PP 3 VP NON-FERROUS. - Pulido espejo de todos los metales: discos de paño TW o FL con pasta de pulir PP 4 HGP UNIVERSAL. - Pulido espejo de plásticos: discos de paño TW o FL con pasta de pulir PP 5 HGP PLAST. Máquinas adecuadas: Máquinas de eje flexible y amoladoras rectas

Ref.	Código	Ancho útil mm	Ø	Ø Agujero mm	Perno adecuado	Material	€/ u.
436200	TR 8010-10 ST	10	80	10	8/10 6-20		8,66
436201	TR 10010-10 ST	10	100	10	8/10 6-20		9,56
436202	TR 12510-10 ST	10	125	20*	12/20 10-50 MK 1/20 10-50	ST sisal verde	10,22
436203	TR 15010-20 ST	10	150	20	12/20 10-50 MK 1/20 10-50		20,33
436204	TR 20010-20 ST	10	200	20	12/20 10-50 MK 1/20 10-50		30,92
436300	TR 8010-10 TH	10	80	10	8/10 6-20		5,02
436301	TR 10010-10 TH	10	100	10	8/10 6-20		5,58
436302	TR 12510-20 TH	10	125	20*	12/20 10-50 MK 1/20 10-50	TH paño duro	7,13
436303	TR 15010-20 TH	10	150	20	12/20 10-50 MK 1/20 10-50		10,03
436304	TR 20010-20 TH	10	200	20	12/20 10-50 MK 1/20 10-50		17,63
436400	TR 8010-10 TW	10	80	10	8/10 6-20		4,25
436401	TR 10010-10 TW	10	100	10	8/10 6-20		4,73
436402	TR 12510-20 TW	10	125	20*	12/20 10-50 MK 1/20 10-50	TW paño blando	6,17
436403	TR 15010-20 TW	10	150	20	12/20 10-50 MK 1/20 10-50		7,23
436404	TR 20010-20 TW	10	200	20	12/20 10-50 MK 1/20 10-50		13,10
436500	TR 8010-10 FL	10	80	10	8/10 6-20		4,73
436501	TR 10010-10 FL	10	100	10	8/10 6-20		5,22
436502	TR 12510-20 FL	10	125	20*	12/20 10-50 MK 1/20 10-50	FL franela	6,25
436503	TR 15010-20 FL	10	150	20	12/20 10-50 MK 1/20 10-50		8,89
436504	TR 20010-20 FL	10	200	20	12/20 10-50 MK 1/20 10-50		15,52



04

Disco de fieltro con inclusión metálica



Los discos de fieltro normalmente se utilizan para pulir con el contorno de la herramienta. Los discos de fieltro con inclusión metálica (MS) se utilizan para un mayor arranque de material en el prepulido y con pastas de pulir de diamante. Máquinas adecuadas: Máquinas de eje flexible y amoladoras rectas.

Ref.	Código	Ancho mm	Ø	Ø Agujero mm	Perno adecuado	r.p.m.	€/ u.
405800	FK SC 8010/10 MS	10	80	10	8/6 6-20	1.000-2.000	30,40
405801	FK SC 10020/10 MS	20	100	10	8/6 6-20	900-1.800	68,53
405802	FK SC 12520/20 MS	20	125	20	12/20 10-50 MK 1/20 10-50	750-1.500	118,62



Disco de fieltro sistema velcro



Ref.	Código	Ø	Perno adecuado	€/ u.
422800	Disco fieltro 115	115	Plato 115 M14 / Plato acolchado 115 M14	11,06
422801	Disco fieltro 125	125	Plato 125 M14 / Plato acolchado 125 M14	12,21



Abanico y disco de láminas de fieltro



Los abanicos y los discos de láminas de fieltro se utilizan junto con las pastas de pulir desde el prepulido hasta el pulido espejo en piezas pequeñas y medianas. La ejecución dura es adecuada para prepulido de superficies planas. La ejecución blanda es adecuada para pulido espejo y para piezas con muchos contornos. Cuando se desee un acabado de superficie muy fino se pueden usar ambas ejecuciones sucesivamente. Para ello hay que utilizar las pastas adecuadas.



Ref.	Código	Ø x altura mm	Ø x long. mango mm	r.p.m. recomendadas	Ejecución	€ / u.
425100	FLS 3020/6 W	30 x 20	6 x 40	6.300	Blanda	10,52
425101	FLS 4020/6 W	40 x 20	6 x 40	4.750	Blanda	11,79
425102	FLS 5030/6 W	50 x 30	6 x 40	3.800	Blanda	15,00
425103	FLS 6040/6 W	60 x 40	6 x 40	3.150	Blanda	20,64
425104	FLS 8050/6 W	80 x 50	6 x 40	2.400	Blanda	29,75
425150	FLS 3020/6 H	30 x 20	6 x 40	6.300	Dura	10,52
425151	FLS 4020/6 H	40 x 20	6 x 40	4.750	Dura	11,79

Ref.	Código	Ø x altura mm	Ø x long. mango mm	r.p.m. recomendadas	Ejecución	€ / u.
425152	FLS 5030/6 H	50 x 30	6 x 40	3.800	Dura	15,00
425153	FLS 6040/6 H	60 x 40	6 x 40	3.150	Dura	20,64
425154	FLS 8050/6 H	80 x 50	6 x 40	2.400	Dura	29,75
425200	FFS 115/22,23 W	22,23	115	1.650	Blanda	34,09
425201	FFS 125/22,23 W	22,23	125	1.500	Blanda	37,87
425250	FFS 115/22,23 H	22,23	115	1.650	Dura	34,09
425251	FFS 125/22,23 H	22,23	125	1.500	Dura	37,87

Plato sistema velcro



Ref.	Código	Ø	€ / u.
422900	Plato 115 M14	115	25,60
422901	Plato acolch. 115 M14	115	31,55
422902	Plato 125 M14	125	27,34
422903	Plato acolch. 125 M14	125	32,27



Pasta de pulir para cuerpos de fieltro



Pastas de amolar solubles en aceite con granos de SiC de ángulo vivo.

Ref.	Código	Contenido gr	Granos según FEPA	€ / u.
406200	SFP 90	250	90	28,04
406201	SFP 150	250	150	29,21
406202	SFP 280	250	280	29,21
406203	SFP 360	250	360	31,24
406204	SFP 600	250	600	34,03
406205	SFP 800	250	800	40,20



Banda de fieltro



Apropiados para pulir con pastas de pulir en estructuras de tubos y barandas. Para realizar el proceso de pulido desde el prepulido hasta el pulido espejo. Al cambiar de pasta de pulir se debe utilizar una nueva banda y así no contaminar el trabajo realizado en el paso anterior. Para obtener un rendimiento óptimo, utilizar a una velocidad de corte recomendada de 5-15 m/s.

Ref.	Código	Ancho mm	Long.	€ / u.	Ref.	Código	Ancho mm	Long.	€ / u.
422950	Banda fieltro BA 6/520	6	520	3,60	422955	Banda fieltro BA 12/610	12	610	7,66
422951	Banda fieltro BA 12/520	12	520	5,67	422956	Banda fieltro BA 20/610	20	610	9,88
422952	Banda fieltro BA 20/520	20	520	8,65	422957	Banda fieltro BA 30/610	30	610	13,86
422953	Banda fieltro BA 30/533	30	533	11,80					



Pasta de diamante para pulir



Las pastas de pulir de diamante se utilizan para el mecanizado de materiales muy duros, por ejemplo metal duro y aceros templados. Se pueden usar con herramientas de fieltro o discos de fieltro. Las pastas de pulido de diamante pueden ser diluidas o disueltas con agua o alcohol. Al utilizar pastas de pulir de diamante primero debe aplicarse la pasta más basta. Si se quiere conseguir un gran acabado de superficie será necesario utilizar varios granos sucesivamente, cada vez más finos y entre grano y grano mantener limpia la superficie. Cuando se cambie de grano hay que asegurarse de usar una herramienta nueva y limpia (por ejemplo muela de fieltro o disco de fieltro).



Ref.	Código	Color tapón	Contenido gr (inyección dosificada)	Grano	€/ u.
406100	DPP 30-5	marrón	5	D 30 = basto	179,64
406101	DPP 30-20	marrón	20	D 30 = basto	363,54
406102	DPP 15-5	azul	5	D 15 = medio	179,64
406104	DPP 7-5	rojo	5	D 7 = fino	179,64
406105	DPP 7-20	rojo	20	D 7 = fino	363,54
406106	DPP 3-5	verde	5	D 3 = muy fino	179,64
406107	DPP 3-20	verde	20	D 3 = muy fino	363,54

Pasta de pulir para discos de paño y muelas de fieltro



Las pastas de pulir se utilizan con herramientas de fieltro y también con los discos de paño para prepulido y pulido espejo. Para conseguir superficies muy lisas se han de emplear varias o incluso todas las ejecuciones una tras otra.



Ref.	Código	Altura mm	Ancho mm	Ejecución / Aplicación	Profund.	€/ u.
406000	G-PP 1 VP STEELOX	50	70	verde - prepulido de acero e INOX	140	16,56
406001	G-PP 2 VP ALU	50	70	gris - prepulido de aluminio y latón	140	10,04
406002	G-PP 3 VP NON-FERROUS	50	70	marrón - prepulido de metales no férricos	140	12,50
406003	G-PP 4 HGP UNIVERSAL	50	70	rosa - pulido espejo de metales	140	14,24
406004	G-PP 5 HGP PLAST	50	70	beige - pulido espejo de plásticos	140	23,74

Rodaja de fieltro COMBICLICK®



• El sistema de fijación rápida y refrigeración patentado por PFERD resulta ideal para discos de lija, herramientas de vellón y de fieltro. • El sistema COMBICLICK® consta de un plato de apoyo especialmente diseñado y un sistema especial de fijación en la trasera de los discos. • Gracias al plato soporte las herramientas COMBICLICK® se pueden utilizar con amoladoras angulares convencionales. • La geometría especial de las ranuras de refrigeración garantiza el paso de gran cantidad de aire, de manera que se reducen la carga térmica del abrasivo y la de la herramienta. • Un buen sistema de fijación, un soporte robusto para asegurar la herramienta y un óptimo sistema de refrigeración logran: - Reducir hasta un 30 % la temperatura de la pieza de trabajo. - Aumentar hasta un 25 % más el arranque de material.



Ref.	Código	Ø mm	r.p.m. máx.	r.p.m. recomendadas	€/ u.
425335	CC-FR 115	115	10.500	1.650	9,76
425336	CC-FR 125	125	9.650	1.500	10,96

Plato de apoyo COMBICLICK®



• El sistema de fijación rápida y refrigeración patentado por PFERD resulta ideal para discos de lija, herramientas de vellón y de fieltro. • El sistema COMBICLICK® consta de un plato de apoyo especialmente diseñado y un sistema especial de fijación en la trasera de los discos. • Gracias al plato soporte las herramientas COMBICLICK® se pueden utilizar con amoladoras angulares convencionales. • La geometría especial de las ranuras de refrigeración garantiza el paso de gran cantidad de aire, de manera que se reducen la carga térmica del abrasivo y la de la herramienta. • Un buen sistema de fijación, un soporte robusto para asegurar la herramienta y un óptimo sistema de refrigeración logran: - Reducir hasta un 30 % la temperatura de la pieza de trabajo. - Aumentar hasta un 25 % más el arranque de material.



Ref.	Código	Adecuado para	r.p.m. máx.	Rosca	€ / u.
425340	CC-GT 115-125 M14	CC ø 115, CC ø 125	13.300	M14	40,40
425341	CC-GT 180 M14	CC ø 180	8.500	M14	51,14

Perno de sujeción con aplicación múltiple



Ref.	Código	Agujero	Campo de sujeción	Ø Mango mm	€ / u.
406300	Perno BO 6/6 3-10	6	3-10	6	11,32
406301	BO 8/10 6-20	10	6-20	8	15,41
406302	Perno BO 12/20 10-50	20	10-50	12	41,74
406303	Perno BO MK1/20 10-50	20	10-50	MK1	52,26



Hojas 7447PRO/7448PRO



Tipo A: Óxido de aluminio Tipo S: Carburo de silicio
 • Soporte tejido sin tejer
 • Alta densidad
 • Recomendado para superficies planas
 • Materiales: INOX, Acero, Madera
 • Máquinas: Lijado manual.



Ref.	Código	Medida mm	Grano	€ / u.
8003241	7100023339	152 x 228	A Muy fino	2,19

Ref.	Código	Medida mm	Grano	€ / u.
8003242	7100023340	152 x 228	S Ultrafino	2,19

3M™ Wetordry™ Hoja de papel 734, 115 mm x 140 mm, P1200



El papel de lija 734 3M™ Wetordry™ está fabricado en un material afilado de abrasivo de carburo de silicio con un cómodo soporte de papel resistente al agua. Nuestras hojas 734 tienen una larga vida útil y buena calidad superficial.

Ref.	Código	Grano	€ / u.
21003107	7000006837	P240	1,10



Disco lijador de fibra FS VICTOGRAIN-COOL



Ejecución VICTOGRAIN-COOL: para un lijado muy agresivo con una tasa de eliminación de Dentado muy alta sobre acero, Dentadoes duros o de baja conductividad térmica y, al mismo tiempo, una vida útil extraordinariamente larga. Rendimiento máximo excelente, constante, gracias al grano abrasivo VICTOGRAIN. Gracias a los aditivos activantes de lijado que contienen se consigue una capacidad de arranque mayor, se evita el embozado y se logra un amolado más frío. La exacta geometría triangular de los granos abrasivos VICTOGRAIN permite un amolado extraordinario. El filo de los granos abrasivos triangulares penetra con el ángulo adecuado en la pieza, lo que hace que cada grano abrasivo necesite poca energía de penetración.



Ref.	Código	ø agujero mm	ø mm	Plato de apoyo recomendado	r.p.m. máx.	Grano	€ / u.
20036482	FS 100-16 VICTOGRAIN-COOL 36	16	100	GT 100 MF M10	15.300	VICTOGRAIN-COOL 36	2,52
20036481	FS 115-22 VICTOGRAIN-COOL 36	22	115	H-GT 115 MF M14	13.300	VICTOGRAIN-COOL 36	3,21
2400753	FS 115-22 VICTOGRAIN-COOL 60	22	115	H-GT 115 MF M14	13.300	VICTOGRAIN-COOL 60	2,67
2400754	FS 115-22 VICTOGRAIN-COOL 80	22	115	H-GT 115 MF M14	13.300	VICTOGRAIN-COOL 80	2,48
20036483	FS 125-22 VICTOGRAIN-COOL 36	22	125	H-GT 125 MF M14	12.200	VICTOGRAIN-COOL 36	3,54
2400755	FS 125-22 VICTOGRAIN-COOL 60	22	125	H-GT 125 MF M14	12.200	VICTOGRAIN-COOL 60	2,95
2400756	FS 125-22 VICTOGRAIN-COOL 80	22	125	H-GT 125 MF M14	12.200	VICTOGRAIN-COOL 80	2,76
2400757	FS 150-22 VICTOGRAIN-COOL 36	22	150	GT 150 MF M14	10.200	VICTOGRAIN-COOL 36	5,86
2400758	FS 150-22 VICTOGRAIN-COOL 60	22	150	GT 150 MF M14	10.200	VICTOGRAIN-COOL 60	5,71
2400759	FS 150-22 VICTOGRAIN-COOL 80	22	150	GT 150 MF M14	10.200	VICTOGRAIN-COOL 80	5,38
20036484	FS 180-22 VICTOGRAIN-COOL 36	22	180	H-GT 180 MF M14	8.500	VICTOGRAIN-COOL 36	7,11
2400760	FS 180-22 VICTOGRAIN-COOL 60	22	180	H-GT 180 MF M14	8.500	VICTOGRAIN-COOL 60	5,90
2400761	FS 180-22 VICTOGRAIN-COOL 80	22	180	H-GT 180 MF M14	8.500	VICTOGRAIN-COOL 80	5,57

Disco lijador de fibra FS VICTOGRAIN



Para un lijado muy agresivo con una tasa de eliminación de material muy alta sobre acero, materiales duros o de baja conductividad térmica y, al mismo tiempo, una vida útil extraordinariamente larga. Rendimiento máximo excelente, constante, gracias al grano abrasivo VICTOGRAIN. Gracias a los aditivos activantes de lijado que contienen se consigue una capacidad de arranque mayor, se evita el embozado y se logra un amolado más frío. La exacta geometría triangular de los granos abrasivos VICTOGRAIN permite un amolado extraordinario. El filo de los granos abrasivos triangulares penetra con el ángulo adecuado en la pieza, lo que hace que cada grano abrasivo necesite poca energía de penetración.



Ref.	Código	ø agujero mm	ø mm	Plato de apoyo recomendado	r.p.m. máx.	Grano	€ / u.
21091006	FS 100-16 VICTOGRAIN 36	16	100	GT 100 MF M10	15.300	VICTOGRAIN 36	2,27
21091007	FS 115-22 VICTOGRAIN 36	22	115	H-GT 115 MF M14	13.300	VICTOGRAIN 36	2,91
2400762	FS 115-22 VICTOGRAIN 60	22	115	H-GT 115 MF M14	13.300	VICTOGRAIN 60	2,44
2400763	FS 115-22 VICTOGRAIN 80	22	115	H-GT 115 MF M14	13.300	VICTOGRAIN 80	2,24
21091008	FS 125-22 VICTOGRAIN 36	22	125	H-GT 125 MF M14	12.200	VICTOGRAIN 36	3,19
2400764	FS 125-22 VICTOGRAIN 60	22	125	H-GT 125 MF M14	12.200	VICTOGRAIN 60	2,67
2400765	FS 125-22 VICTOGRAIN 80	22	125	H-GT 125 MF M14	12.200	VICTOGRAIN 80	2,48
2400766	FS 150-22 VICTOGRAIN 36	22	150	GT 150 MF M14	10.200	VICTOGRAIN 36	5,28
2400767	FS 150-22 VICTOGRAIN 60	22	150	GT 150 MF M14	10.200	VICTOGRAIN 60	5,20
2400768	FS 150-22 VICTOGRAIN 80	22	150	GT 150 MF M14	10.200	VICTOGRAIN 80	4,87
21091009	FS 180-22 VICTOGRAIN 36	22	180	H-GT 180 MF M14	8.500	VICTOGRAIN 36	6,39
2400769	FS 180-22 VICTOGRAIN 60	22	180	H-GT 180 MF M14	8.500	VICTOGRAIN 60	5,29
2400770	FS 180-22 VICTOGRAIN 80	22	180	H-GT 180 MF M14	8.500	VICTOGRAIN 80	5,01

Herramientas Combiclick®: Todo el proceso de pulido sin cambiar de plato de apoyo

- El sistema de fijación rápida y refrigeración patentado por PFERD resulta ideal para discos de lija, herramientas de vellón y de fieltro.
- El sistema Combiclick® consta de un plato de apoyo especialmente diseñado y un sistema especial de fijación en la trasera de los discos.
- Gracias al plato soporte las herramientas Combiclick® se pueden utilizar con amoladoras angulares convencionales.
- La geometría especial de las ranuras de refrigeración garantiza el paso de gran cantidad de aire, de manera que se reducen la carga térmica del abrasivo y la de la herramienta.
- Un buen sistema de fijación, un soporte robusto para asegurar la herramienta y un óptimo sistema de refrigeración logran:
 - Reducir hasta un 30 % la temperatura de la pieza de trabajo.
 - Aumentar hasta un 25 % más el arranque de material.



Disco de lija Sistema COMBICLICK® VICTOGRAIN

Para lijado muy agresivo con la máxima capacidad de eliminación de material sobre materiales de acero y materiales duros y una vida útil de la herramienta realmente larga. Rendimiento máximo excelente y constante, gracias al grano abrasivo VICTOGRAIN. La exacta geometría triangular de los granos abrasivos VICTOGRAIN permite un amolado extraordinario. El filo de los granos abrasivos triangulares penetra con el ángulo adecuado en la pieza, lo que hace que cada grano abrasivo necesite poca energía de penetración.



Ref.	Código	Ø mm	r.p.m. máx.	Grano	€/ u.
21091010	CC-FS 100 VICTOGRAIN 36	100	15.300	VICTOGRAIN 36	2,59
21091011	CC-FS 115 VICTOGRAIN 36	115	13.300	VICTOGRAIN 36	3,55
21091012	CC-FS 125 VICTOGRAIN 36	125	12.200	VICTOGRAIN 36	3,81
21091013	CC-FS 180 VICTOGRAIN 36	180	8.500	VICTOGRAIN 36	6,89

Disco de lija Sistema COMBICLICK® A-COOL



El sistema de fijación rápida y refrigeración patentado por PFERD resulta ideal para discos de lija, herramientas de vellón y de fieltro. El sistema COMBICLICK® consta de un plato de apoyo especialmente diseñado y un sistema especial de fijación en la trasera de los discos. Gracias al plato soporte las herramientas COMBICLICK® se pueden utilizar con amoladoras angulares convencionales. La geometría especial de las ranuras de refrigeración garantiza el paso de gran cantidad de aire, de manera que se reducen la carga térmica del abrasivo y la de la herramienta. Un buen sistema de fijación, un soporte robusto para asegurar la herramienta y un óptimo sistema de refrigeración logran: - Reducir hasta un 30 % la temperatura de la pieza de trabajo. - Aumentar hasta un 25 % más el arranque de material.



Ref.	Código	Ø mm	r.p.m. máx.	grano	€/ u.	Ref.	Código	Ø mm	r.p.m. máx.	grano	€/ u.
425210	CC-FS 125 A 50 COOL	125	12.200	50	2,55	425231	CC-FS 125 A 120 COOL	125	12.200	120	2,35
425215	CC-FS 115 A 60 COOL	115	13.300	60	2,23	425235	CC-FS 115 A 150 COOL	115	13.300	150	2,06
425216	CC-FS 125 A 60 COOL	125	12.200	60	2,41	425236	CC-FS 125 A 150 COOL	125	12.200	150	2,35
425225	CC-FS 115 A 80 COOL	115	13.300	80	2,06	425240	CC-FS 125 A 180 COOL	125	12.200	180	2,35
425226	CC-FS 125 A 80 COOL	125	12.200	80	2,35	425245	CC-FS 115 A 220 COOL	115	13.300	180	2,06
425230	CC-FS 115 A 120 COOL	115	13.300	120	2,06	425246	CC-FS 125 A 220 COOL	125	12.200	220	2,35

Disco de lija Sistema COMBICLICK® CO-COOL



El sistema de fijación rápida y refrigeración patentado por PFERD resulta ideal para discos de lija, herramientas de vellón y de fieltro. El sistema COMBICLICK® consta de un plato de apoyo especialmente diseñado y un sistema especial de fijación en la trasera de los discos. Gracias al plato soporte las herramientas COMBICLICK® se pueden utilizar con amoladoras angulares convencionales. La geometría especial de las ranuras de refrigeración garantiza el paso de gran cantidad de aire, de manera que se reducen la carga térmica del abrasivo y la de la herramienta. Un buen sistema de fijación, un soporte robusto para asegurar la herramienta y un óptimo sistema de refrigeración logran: - Reducir hasta un 30 % la temperatura de la pieza de trabajo. - Aumentar hasta un 25 % más el arranque de material.



Ref.	Código	Ø mm	r.p.m. máx.	grano	€/ u.
425260	CC-FS 115 CO 24 COOL	115	13.300	24	5,20
425261	CC-FS 125 CO 24 COOL	125	12.200	24	5,20
425262	CC-FS 180 CO 24 COOL	180	8.500	24	5,44
425265	CC-FS 115 CO 36 COOL	115	13.300	36	5,44
425266	CC-FS 125 CO 36 COOL	125	12.200	36	9,56
425267	CC-FS 180 CO 36 COOL	180	8.500	36	9,56
425270	CC-FS 115 CO 50 COOL	115	13.300	50	3,58
425271	CC-FS 125 CO 50 COOL	125	12.200	50	3,86
425272	CC-FS 180 CO 50 COOL	180	8.500	50	7,00

Ref.	Código	Ø mm	r.p.m. máx.	grano	€/ u.
425275	CC-FS 115 CO 60 COOL	115	13.300	60	3,01
425276	CC-FS 125 CO 60 COOL	125	12.200	60	3,22
425277	CC-FS 180 CO 60 COOL	180	8.500	60	5,96
425280	CC-FS 115 CO 80 COOL	115	13.300	80	2,77
425281	CC-FS 125 CO 80 COOL	125	12.200	80	2,95
425282	CC-FS 180 CO 80 COOL	180	8.500	80	5,44
425285	CC-FS 115 CO 120 COOL	115	13.300	120	2,77
425286	CC-FS 125 CO 120 COOL	125	12.200	120	2,95

Disco de lija Sistema COMBICLICK® VICTOGRAIN-COOL



Para un lijado muy agresivo con una tasa de eliminación de material muy alta sobre acero, materiales duros o de baja conductividad térmica y, al mismo tiempo, una vida útil extraordinariamente larga. Rendimiento máximo excelente, constante, gracias al grano abrasivo VICTOGRAIN. Gracias a los aditivos activantes de lijado que contienen se consigue una capacidad de arranque mayor, se evita el embozado y se logra un amolado más frío. La exacta geometría triangular de los granos abrasivos VICTOGRAIN permite un amolado extraordinario. El filo de los granos abrasivos triangulares penetra con el ángulo adecuado en la pieza, lo que hace que cada grano abrasivo necesite poca energía de penetración.



Ref.	Código	Ø mm	r.p.m. máx.	Grano	€/ u.
20036487	CC-FS 100 VICTOGRAIN-COOL 36	100	15.300	VICTOGRAIN-COOL 36	2,86
20036486	CC-FS 115 VICTOGRAIN-COOL 36	115	13.300	VICTOGRAIN-COOL 36	3,93
20036488	CC-FS 125 VICTOGRAIN-COOL 36	125	12.200	VICTOGRAIN-COOL 36	4,23
20036489	CC-FS 180 VICTOGRAIN-COOL 36	180	8.500	VICTOGRAIN-COOL 36	7,67

Mini disco de lija Sistema Combidisc VICTOGRAIN-COOL



Ejecución VICTOGRAIN-COOL: para un lijado muy agresivo con una tasa de eliminación de material muy alta sobre acero, materiales duros o de baja conductividad térmica y, al mismo tiempo, una vida útil extraordinariamente larga. Rendimiento máximo excelente, constante, gracias al grano abrasivo VICTOGRAIN. Gracias a los aditivos activantes de lijado que contienen se consigue una capacidad de arranque mayor, se evita el embozado y se logra un amolado más frío. La exacta geometría triangular de los granos abrasivos VICTOGRAIN permite un amolado extraordinario. El filo de los granos abrasivos triangulares penetra con el ángulo adecuado en la pieza, lo que hace que cada grano abrasivo necesite poca energía de penetración.



Ref.	Código	Sistema	Ø mm	Tipo de grano	€/ u.
20036485	CD 38 VICTOGRAIN-COOL	COMBIDISC CD	38	VICTOGRAIN-COOL	2,09
20036496	CD 50 VICTOGRAIN-COOL	COMBIDISC CD	50	VICTOGRAIN-COOL	2,94
20036497	CD 75 VICTOGRAIN-COOL	COMBIDISC CD	75	VICTOGRAIN-COOL	4,19
20036498	CDR 38 VICTOGRAIN-COOL	COMBIDISC CDR	38	VICTOGRAIN-COOL	2,09
20036499	CDR 50 VICTOGRAIN-COOL	COMBIDISC CDR	50	VICTOGRAIN-COOL	2,94
20036500	CDR 75 VICTOGRAIN-COOL	COMBIDISC CDR	75	VICTOGRAIN-COOL	4,19

Clean & Strip rígido Azul (CG-RD)



Mineral carburo de silicio • Soporte tejido sin tejer • Accesorios: Utilizar con los platos soporte PN09583 y PN09921 • Materiales: INOX, Acero • Máquinas: Amoladora recta.



Ref.	Código	Medida mm	Grano	€ / u.
8003302	7000077972	115	X Basto	13,12

Disco lijador de fibra FS Corindón A



Para todo tipo de trabajos de lijado, desde lijado basto a lijado fino, en industria y taller. Abrasivo: Corindón A



Ref.	Código	Agujero	Ø	Plato de apoyo recomendado	r.p.m. máx.	grano	€ / u.
436600	FS 115-22 A 16	22,2	115	GT 115 MF M 14	13.300	16	1,50
436601	FS 125-22 A 16	22,2	125	GT 125 MF M 14	12.200	16	1,81
436603	FS 180-22 A 16	22,2	180	GT 180 MF M 14	8.500	16	3,14
436700	FS 115-22 A 24	22,2	115	GT 115 MF M 14	13.300	24	1,47
436701	FS 125-22 A 24	22,2	125	GT 125 MF M 14	12.200	24	1,67
436703	FS 180-22 A 24	22,2	180	GT 180 MF M 14	8.500	24	2,92
436800	FS 115-22 A 36	22,2	115	GT 115 MF M 14	13.300	36	1,43
436801	FS 125-22 A 36	22,2	125	GT 125 MF M 14	12.200	36	1,61
436802	FS 150-22 A 36	22,2	150	GT 150 MF M 14	10.200	36	2,27
436803	FS 180-22 A 36	22,2	180	GT 180 MF M 14	8.500	36	2,70
436900	FS 115-22 A 50	22,2	115	GT 115 MF M 14	13.300	50	1,29
436903	FS 180-22 A 50	22,2	180	GT 180 MF M 14	8.500	50	2,38
437000	FS 115-22 A 60	22,2	115	GT 115 MF M 14	13.300	60	1,29

Ref.	Código	Agujero	Ø	Plato de apoyo recomendado	r.p.m. máx.	grano	€ / u.
437001	FS 125-22 A 60	22,2	125	GT 125 MF M 14	12.200	60	1,40
437002	FS 150-22 A 60	22,2	150	GT 150 MF M 14	10.200	60	1,91
437003	FS 180-22 A 60	22,2	180	GT 180 MF M 14	8.500	60	2,22
437100	FS 115-22 A 80	22,2	115	GT 115 MF M 14	13.300	80	1,23
437101	FS 125-22 A 80	22,2	125	GT 125 MF M 14	12.200	80	1,36
437102	FS 150-22 A 80	22,2	150	GT 150 MF M 14	10.200	80	1,87
437103	FS 180-22 A 80	22,2	180	GT 180 MF M 14	8.500	80	2,24
437200	FS 115-22 A 100	22,2	115	GT 115 MF M 14	13.300	100	1,23
437201	FS 125-22 A 100	22,2	125	GT 125 MF M 14	12.200	100	1,36
437203	FS 180-22 A 100	22,2	180	GT 180 MF M 14	8.500	100	2,24
437300	FS 115-22 A 120	22,2	115	GT 115 MF M 14	13.300	120	1,23
437301	FS 125-22 A 120	22,2	125	GT 125 MF M 14	12.200	120	1,36
437303	FS 180-22 A 120	22,2	180	GT 180 MF M 14	8.500	120	2,24

Plato de apoyo de plástico para discos lijadores



Ref.	Código	Ø	€ / u.	Ref.	Código	Ø	€ / u.
407500	GT 115 MF M10	115	15,44	407503	GT 150 MF M14	150	18,78
407501	GT 115 MF M14	115	15,44	407504	GT 180 MF M14	180	25,34
407502	GT 125 MF M14	125	18,20				



Plato de apoyo de elevada resistencia para discos lijadores



Ref.	Código	€ / u.
407000	H-GT 115 MF M14	18,78
407001	H-GT 125 MF M14	23,08
407002	H-GT 180 MF M14	34,16



3M™ Cubitron™ II disco de fibra 982C



El disco de fibra 982C 3M™ Cubitron™ II supera en rendimiento a los discos abrasivos cerámicos convencionales de uso industrial. Nuestros discos cuentan con tecnología PSG 3M y, con menos presión, brindan hasta dos veces más tasa de corte, duración y vida útil que los discos convencionales.



Ref.	Código	Medida mm	Grano	€/ u.
21003070	7000000402	100	P-36	2,88
21003072	7000028192	115	p-36	3,11
21003073	7000028194	115	P-60	2,75
21003074	7000028196	115	P-80	2,66
21003075	7000028191	127	P-36	3,30
21003076	7000028195	125	P-60	3,05

Ref.	Código	Medida mm	Grano	€/ u.
21003077	7000028197	125	P-80	2,90
21003078	7000045230	150	P-36	4,88
21003079	7000028201	180	P-36	6,38
21003080	7000028203	180	P-60	5,87
21003081	7000028204	180	P-80	5,61
21003082	7000000393	178	P-36	6,38

3M™ Cubitron™ II disco de fibra 987C



El disco de fibra 987C 3M™ Cubitron™ II brinda una tasa de corte más elevada, más duración y más vida útil que otros discos de fibra y discos de desbaste. Nuestros discos utilizan grano PSG 3M combinado con soporte de fibra rígida para mayor productividad en tareas de carga media a exigente.



Ref.	Código	Medida mm	Grano	€/ u.
21003083	7000045159	115	P-36	3,31
21003084	7000045160	115	P-60	2,92
21003085	7000045161	115	P-80	2,78
21003086	7000028193	125	P-36	3,47
21003087	7000028199	125	P-60	3,16

Ref.	Código	Medida mm	Grano	€/ u.
21003088	7000028200	125	P-80	2,97
21003089	7000045188	180	P-36	6,48
21003090	7000045186	180	P-60	5,89
21003091	7000045187	180	P-80	5,74

Disco lijador de fibra FS Corindón de Circonio Z



Para trabajos de lijado bastos con elevada capacidad de arranque y larga vida útil. Abrasivo: Corindón de circonio Z



Ref.	Código	Agujero	Ø	Plato de apoyo recomendado	r.p.m. máx.	grano	€/ u.
437400	FS 115-22 Z 24	22,2	115	GT 115 MF M 14	13.300	24	2,50
437401	FS 125-22 Z 24	22,2	125	GT 125 MF M 14	12.200	24	2,70
437402	FS 180-22 Z 24	22,2	180	GT 180 MF M 14	8.500	24	4,46
437500	FS 115-22 Z 36	22,2	115	GT 115 MF M 14	13.300	36	2,21
437601	FS 125-22 Z 36	22,2	125	GT 125 MF M 14	12.200	36	2,42
437602	FS 180-22 Z 36	22,2	180	GT 180 MF M 14	8.500	36	4,19
437600	FS 115-22 Z 50	22,2	115	GT 115 MF M 14	13.300	50	1,72
437700	FS 115-22 Z 60	22,2	115	GT 115 MF M 14	13.300	60	1,50

Ref.	Código	Agujero	Ø	Plato de apoyo recomendado	r.p.m. máx.	grano	€/ u.
437701	FS 125-22 Z 60	22,2	125	GT 125 MF M 14	12.200	60	1,72
437702	FS 180-22 Z 60	22,2	180	GT 180 MF M 14	8.500	60	2,86
437800	FS 115-22 Z 80	22,2	115	GT 115 MF M 14	13.300	80	1,39
437801	FS 125-22 Z 80	22,2	125	GT 125 MF M 14	12.200	80	1,64
437802	FS 180-22 Z 80	22,2	180	GT 180 MF M 14	8.500	80	2,54
438000	FS 115-22 Z 120	22,2	115	GT 115 MF M 14	13.300	120	1,39
438001	FS 125-22 Z 120	22,2	125	GT 125 MF M 14	12.200	120	1,64
438002	FS 180-22 Z 120	22,2	180	GT 180 MF M 14	8.500	120	2,54





Disco lijador de fibra FS grano cerámico

Para lijado agresivo con máxima capacidad de arranque y muy buena duración. El agresivo poder de arranque del grano cerámico y los componentes activos en el soporte del grano tienen como resultado una herramienta muy adecuada para el trabajo de aceros de alta aleación, Inox, titanio, aleaciones de níquel y superficies extremadamente duras. Se utilizan con amoladoras angulares de elevada potencia.



Ref.	Código	Agujero	Ø	Plato de apoyo recomendado	r.p.m. máx.	grano	€/ u.
438100	FS 115-22 CO 24	22,2	115	GT 115 MF M 14	13.300	24	2,80
438101	FS 125-22 CO 24	22,2	125	GT 125 MF M 14	12.200	24	2,88
438102	FS 180-22 CO 24	22,2	180	GT 180 MF M 14	8.500	24	5,12
438200	FS 115-22 CO 36	22,2	115	GT 115 MF M 14	13.300	36	2,58
438201	FS 125-22 CO 36	22,2	125	GT 125 MF M 14	12.200	36	2,72
438202	FS 180-22 CO 36	22,2	180	GT 180 MF M 14	8.500	36	4,78
438301	FS 125-22 CO 50	22,2	125	GT 125 MF M 14	12.200	50	2,36

Ref.	Código	Agujero	Ø	Plato de apoyo recomendado	r.p.m. máx.	grano	€/ u.
438400	FS 115-22 CO 60	22,2	115	GT 115 MF M 14	13.300	60	1,99
438401	FS 125-22 CO 60	22,2	125	GT 125 MF M 14	12.200	60	2,12
438402	FS 180-22 CO 60	22,2	180	GT 180 MF M 14	8.500	60	3,97
438500	FS 115-22 CO 80	22,2	115	GT 115 MF M 14	13.300	80	1,90
438501	FS 125-22 CO 80	22,2	125	GT 125 MF M 14	12.200	80	2,12
438502	FS 180-22 CO 80	22,2	180	GT 180 MF M 14	8.500	80	3,78
438701	FS 125-22 CO 120	22,2	125	GT 125 MF M 14	12.200	120	2,12

Disco de fibra Cubitron™ II - 787C



Soporte de fibra

- Con aditivo refrigerante
- Aplicaciones: Amolado de soldadura, eliminación de material base y homogeneización de superficies • Para acero inoxidable y las aleaciones con grandes concentraciones de níquel.
- Biselado de piezas
- Ojo trabajar en superficies planas
- Para los granos 60+, 80+ y 120+ se utiliza preferentemente el plato rojo liso según medida (PN64857, 64858 y 64859)
- Para el grano 36+ se recomienda utilizar el plato rojo duro (estriado) según medida (64860, 64861 y 64862)



Ref.	Código	Medida mm	Grano	€/ u.
8003142	7100099787	115	P-36	1,96
8003143	7100099260	115	P-60	1,96
8003144	7100099254	115	P-80	1,96
8003145	7100099791	115	P-120	1,96
8003146	7100099788	125	P-36	2,16
8003147	7100099245	125	P-60	2,16

Ref.	Código	Medida mm	Grano	€/ u.
8003148	7100099256	125	P-80	2,16
8003149	7100099546	125	P-120	2,31
8003150	7100099257	178	P-36	3,77
8003151	7100099247	178	P-60	3,77
8003152	7100099240	178	P-80	3,77
8003153	7100099243	178	P-120	3,77

Disco de fibra Cubitron™ II - 782C



Soporte de fibra

- Con aditivo refrigerante
- Aplicaciones: Amolado de soldadura, eliminación de material base y homogeneización de superficies • Para acero al carbono.
- Biselado de piezas
- Ojo trabajar en superficies planas
- Para los granos 60+, 80+ y 120+ se utiliza preferentemente el plato rojo liso según medida (PN64857, 64858 y 64859)
- Para el grano 36+ se recomienda utilizar el plato rojo duro (estriado) según medida (64860, 64861 y 64862)



Ref.	Código	Medida mm	Grano	€/ u.
8003157	7100099545	115	P-36	2,03
8003158	7100099250	115	P-60	2,03
8003159	7100099093	115	P-80	1,90
8003160	7100099576	125	P-36	2,08
8003161	7100099094	125	P-60	2,08

Ref.	Código	Medida mm	Grano	€/ u.
8003162	7100099095	125	P-80	2,08
8003163	7100099284	178	P-36	3,72
8003164	7100099091	178	P-60	3,97
8003165	7100099237	178	P-80	3,97

Disco de fibra Cubitron™ 3 - 1187C



El disco de fibra 3M™ Cubitron™ 3 1187C aumenta la productividad de forma significativa en operaciones de intensidad media a alta gracias al nuevo grano PSG 3M de rendimiento excepcional combinado con un soporte de fibra rígida. Este disco alcanza una mayor velocidad de corte, mayor durabilidad y una vida útil más larga que otros discos de fibra, y todo con menos presión de desbaste.



Ref.	Código	Descripción	Ø mm	Grano	€/ u.
2400771	7100309789	Ranurado	115	PSG 3M	3,64
2400772	7100310794	Ranurado	125	PSG 3M	3,82

Ref.	Código	Descripción	Ø mm	Grano	€/ u.
2400773	7100309787	Ranurado	150	PSG 3M	5,64
2400774	7100309795	Ranurado	180	PSG 3M	7,13

Disco de fibra Cubitron™ 3 - 1182C



El disco de fibra 3M™ Cubitron™ 3 1182C dispone del grano PSG 3M rediseñado, lo que lleva la legendaria velocidad y vida útil de los abrasivos de alto rendimiento 3M™ Cubitron™ a un nivel completamente nuevo. Las ventajas de este producto son que aumenta la productividad y reduce los costes generales de desbaste en comparación con otros discos de fibra y discos de desbaste con centro hundido al desbastar aceros templados o al carbono. Este disco de fibra de larga duración, que elimina hasta un 60 % más de material sobrante que el disco de fibra 3M™ Cubitron™ II 982C, 36+, tiene una velocidad de corte rápida con gran eliminación de material sobrante en una amplia gama de presiones de aplicación. Además, este disco está diseñado para ayudar a reducir la exposición a la vibración de la mano y el brazo, aumentar la productividad y completar más piezas por disco en aplicaciones de desbaste de presión media a alta.



Ref.	Código	Descripción	Ø mm	Grano	€/ u.
2400775	7100309905	Ranurado	100	PSG 3M	3,17
2400776	7100308530	Ranurado	115	PSG 3M	3,42
2400777	7100308531	Ranurado	125	PSG 3M	3,63

Ref.	Código	Descripción	Ø mm	Grano	€/ u.
2400778	7100309790	Ranurado	150	PSG 3M	5,37
	7100309904	Agujero interior 22mm	177.8	PSG 3M	#N/A
2400779	7100309794	Ranurado	180	PSG 3M	7,02

Disco Surface Conditioning GB DH fibra HD. Agujero interior 22mm



Mineral cerámico Cubitron™™

- Soporte tejido sin tejer
- Hookit
- Malla más agresiva
- Desbaste y acabado en un solo paso
- Poco flexible y más agresivo que el SE
- Debido a la superficie semi cerámica es idea para el primer paso después del desbaste
- Poco flexible y más agresivo que el SE
- Accesorios: Utilizar con los platos soportes PN09562, PN00915 y PN07394
- Materiales: INOX, Acero
- Máquinas: Amoladora angular.



Ref.	Código	Medida mm	Grano	€/ u.
8003291	7000046245	125 x 22	Basto	4,27
8003290	7000046263	115 x 22	Basto	3,72

Ref.	Código	Medida mm	Grano	€/ u.
8003292	7000046249	178 x 22	Basto	10,52



Disco Surface Conditioning GB DH fibra SD. Agujero interior 22mm



Mineral cerámico Cubitron™™

- Soporte tejido sin tejer
- Hookit
- Malla más agresiva
- Desbaste y acabado en un solo paso
- Poco flexible y más agresivo que el SE
- Debido a la superficie semi cerámica es idea para el primer paso después del desbaste
- Poco flexible y más agresivo que el SE
- Accesorios: Utilizar con los platos soportes PN09562, PN00915 y PN07394
- Materiales: INOX, Acero
- Máquinas: Amoladora angular.



Ref.	Código	Medida mm	Grano	€ / u.
8003294	7000046247	125 x 22	Basto	4,27
8003293	7000046264	115 x 22	Basto	3,72

Ref.	Código	Medida mm	Grano	€ / u.
8003295	7000046248	178 x 22	Basto	10,52

Disco Surface Conditioning SC-DH. Sin agujero



Óxido de aluminio y carburo de silicio

- Soporte tejido sin tejer
- Hookit
- Malla más agresiva
- Desbaste y acabado en un solo paso
- Poco flexible y más agresivo que el SE
- Debido a la superficie semi cerámica es idea para el primer paso después del desbaste
- Hookit Accesorios: Utilizar con los platos soportes PN09562, PN00915 y PN07394
- Materiales: INOX, Acero
- Máquinas: Amoladora angular.



Ref.	Código	Medida mm	Grano	€ / u.
8003266	7000046019	115	A Basto	3,48

Ref.	Código	Medida mm	Grano	€ / u.
8003267	7000046018	115	A Medio	3,48

Disco Surface Conditioning SC-DH. Agujero interior 22mm



Óxido de aluminio y carburo de silicio

- Soporte tejido sin tejer
- Hookit
- Malla más agresiva
- Desbaste y acabado en un solo paso
- Poco flexible y más agresivo que el SE
- Debido a la superficie semi cerámica es idea para el primer paso después del desbaste
- Hookit Accesorios: Utilizar con los platos soportes PN09562, PN00915 y PN07394
- Materiales: INOX, Acero
- Máquinas: Amoladora angular.



Ref.	Código	Medida mm	Grano	€ / u.
8003268	7100233608	115	A Basto	3,48
8003269	7100233812	115	A Medio	3,48

Ref.	Código	Medida mm	Grano	€ / u.
8003270	7100233795	115	A Muy fino	3,48

04

Disco Surface Conditioning SC-DH. Sin agujero



Óxido de aluminio y carburo de silicio

- Soporte tejido sin tejer
- Hookit
- Malla más agresiva
- Desbaste y acabado en un solo paso
- Poco flexible y más agresivo que el SE
- Debido a la superficie semi cerámica es idea para el primer paso después del desbaste
- Hookit Accesorios: Utilizar con los platos soportes PN09562, PN00915 y PN07394
- Materiales: INOX, Acero
- Máquinas: Amoladora angular.



Ref.	Código	Medida mm	Grano	€ / u.
8003278	7100234022	125	S S. fino	4,00
8003271	7100233774	115	A Basto	3,48
8003272	7100233776	115	A Medio	3,48
8003273	7100233439	115	A Muy fino	3,48

Ref.	Código	Medida mm	Grano	€ / u.
8003274	7100233813	115	S S. fino	3,48
8003275	7100233623	125	A Basto	4,00
8003276	7100233806	125	A Medio	4,00
8003277	7100233440	125	A Muy fino	4,00

Disco Surface Conditioning SC-DH. Agujero interior 22mm



Óxido de aluminio y carburo de silicio

- Soporte tejido sin tejer
- Hookit
- Malla más agresiva
- Desbaste y acabado en un solo paso
- Poco flexible y más agresivo que el SE
- Debido a la superficie semi cerámica es idea para el primer paso después del desbaste
- Hookit Accesorios: Utilizar con los platos soportes PN09562, PN00915 y PN07394
- Materiales: INOX, Acero
- Máquinas: Amoladora angular.



Ref.	Código	Medida mm	Grano	€ / u.
8003280	7100233803	125	A Medio	4,00
8003281	7100234045	125	A Muy fino	4,00

Ref.	Código	Medida mm	Grano	€ / u.
8003279	7100233609	125	A Basto	4,00

Disco Surface Conditioning SC-DH. Sin agujero



Óxido de aluminio y carburo de silicio

- Soporte tejido sin tejer
- Hookit
- Malla más agresiva
- Desbaste y acabado en un solo paso
- Poco flexible y más agresivo que el SE
- Debido a la superficie semi cerámica es idea para el primer paso después del desbaste
- Hookit Accesorios: Utilizar con los platos soportes PN09562, PN00915 y PN07394
- Materiales: INOX, Acero
- Máquinas: Amoladora angular.



Ref.	Código	Medida mm	Grano	€ / u.
8003282	7000068088	150	A Muy fino	5,09

Ref.	Código	Medida mm	Grano	€ / u.
8003283	7100233606	178	A Basto	9,83



Disco Surface Conditioning SC-DH. Agujero interior 22mm



Óxido de aluminio y carburo de silicio

- Soporte tejido sin tejer
- Hookit
- Malla más agresiva
- Desbaste y acabado en un solo paso
- Poco flexible y más agresivo que el SE
- Debido a la superficie semi cerámica es idea para el primer paso después del desbaste
- Hookit Accesorios: Utilizar con los platos soportes PN09562, PN00915 y PN07394
- Materiales: INOX, Acero
- Máquinas: Amoladora angular.



Ref.	Código	Medida mm	Grano	€ / u.
8003289	7100233809	178	A Muy fino	9,83

Ref.	Código	Medida mm	Grano	€ / u.
8003288	7100233775	178	A Medio	9,83

3M™ Cubitron™ II Hookit™ disco 775L – Sin agujeros



El 3M™ Cubitron™ II Hookit™ disco de film 775L incluye 3M grano cerámico con forma de precisión, un avance revolucionario en tecnología de abrasivos. Nuestros discos de film cortan el doble de rápido y duran hasta seis veces más que los abrasivos normales.



Ref.	Código	Medida mm	Grano	€ / u.
21003100	7100145407	152,4	240+	1,15
21003101	7100145462	152,4	320+	1,15

Ref.	Código	Medida mm	Grano	€ / u.
21003102	7100145469	152,4	400+	1,15

3M™ Cubitron™ II Hookit™ disco 775L – Multiagujeros



El disco de film Clean Sanding 3M™ Cubitron™ II Hookit™ 775L corta el doble de rápido y dura hasta seis veces más que los abrasivos convencionales. Nuestros discos de film son ideales para un gran número de aplicaciones centradas sobre todo en la extracción de material y son eficaces en una amplia variedad de sustratos.



Ref.	Código	Medida mm	Grano	€ / u.
21003092	7100045073	152,4	120+	1,15
21003093	7100065918	152,4	150+	1,15
21003094	7100064178	152,4	180+	1,15
21003095	7100064271	152,4	220+	1,15

Ref.	Código	Medida mm	Grano	€ / u.
21003096	7100145316	152,4	240+	1,15
21003097	7100141692	152,4	320+	1,15
21003098	7100145455	152,4	400+	1,15
21003099	7100045072	152,4	80+	1,12

3M™ Cubitron™ II disco de láminas 967A, plano



El disco de láminas 967A 3M™ Cubitron™ II brinda excelentes tasas de corte en aplicaciones de presión baja a media-alta. Nuestros discos son ideales para superficies planas o fuera del borde de trabajo, especialmente donde el acabado final y no dejar marcas es importante.



Ref.	Código	Medida mm	Grano	€ / u.
21003120	7000104371	115	40+	6,86
21003121	7000104372	115	60+	6,86
21003122	7000104373	115	80+	6,86
21003123	7000104374	125	40+	7,13
21003124	7000104375	125	60+	7,13

Ref.	Código	Medida mm	Grano	€ / u.
21003125	7000104376	125	80+	7,13
21003126	7000104377	180	40+	11,85
21003127	7000104378	180	60+	11,85
21003128	7000104379	180	80+	11,85

Clean & Strip soporte fibra Azul (CG-DB)



- Mineral carburo de silicio
- Soporte tejido sin tejer • Accesorios: Utilizar con los mandriles 07947 y 07948
- Materiales: INOX, Acero
- Máquinas: Motor de bancada, Amoladora recta



Ref.	Código	Medida mm	Grano	€ / u.
8003298	7100093990	115	X Basto	12,87
8003299	7100093991	178	X Basto	19,23

Rollo Scotch-Brite WR



- Tipo A: Óxido de aluminio
- Tipo S: Carburo de silicio
- Soporte tejido sin tejer
- Fibra "Wear Resistant"
- Alta densidad
- Materiales: INOX, Acero, Madera
- Máquinas: Lijado manual.



Ref.	Código	Medida mm	Grano	€ / u.
8003260	7100182511	10 m x 125	A medio	139,37

Disco Scotch-Brite™ Clean and Strip XT Pro Extra Cut



El disco Scotch-Brite™ Clean and Strip XT Pro Extra Cut cuenta con un mineral abrasivo de óxido de aluminio incorporado en una malla de nylon abierta. Nuestros discos están diseñados para eliminar revestimientos duros, como capas gruesas de óxido o pintura, y corrosión, al mismo tiempo que homogeneizan y refinan el metal a la vista que se encuentra debajo.

Ref.	Código	Medida mm	Formato	€ / u.
21003159	7100175138	100	XC-DC	11,31
21003160	7100175139	150	XC-DC	17,99
21003161	7100191877	150	XC-DC	18,26
21003162	7100175140	200	XC-DC	28,66
21003163	7100192336	115	XC-RD	18,60
21003164	7100192337	125	XC-RD	21,83
21003165	7100192341	125	XC-RD	21,23
21003166	7100192338	177,8	XC-RD	30,13
21003167	7100192339	115	XC-DB	19,31
21003168	7100192340	177,8	XC-DB	23,47
21003169	7100192737	100	XC-ZS	15,94
21003170	7100192739	100	XB-ZS	27,15
21003171	7100192738	150	XC-ZS	26,17
21003172	7100192735	75	XC-ZS	14,17
21003173	7100192736	75	XB-ZS	16,37



Disco Scotch-Brite™ Clean and Strip XT Pro



El disco Scotch-Brite™ Clean and Strip XT Pro cuenta con un mineral abrasivo de carburo de silicio incorporado en una malla de nylon abierta. Nuestros discos eliminan eficazmente óxido, pintura, calamina, recubrimientos y adhesivos de las superficies sin alterar significativamente el material base.

Ref.	Código	Medida mm	Formato	€ / u.
21003174	7100176374	100	S XCRS	11,06
21003175	7100176347	150	S XCRS	16,20
21003176	7100176348	200	S XCRS	24,09
21003177	7100192330	115	S XCRS	17,68
21003178	7100192331	125	S XCRS	20,35
21003179	7100192335	125	S XCRS	20,48
21003180	7100192332	177,8	S XCRS	28,24
21003181	7100192333	115	S XCRS	16,75
21003182	7100192334	177,8	S XCRS	26,72
21003183	7100192709	100	S XCRS	15,05
21003184	7100192711	100	S XCRS	26,49
21003185	7100192710	150	S XCRS	23,42
21003186	7100192708	75	S XCRS	19,50
21003187	7100192707	75	S XCRS	12,68



3M™ Plato para el Disco de Fibra Plano



El soporte para discos de fibra 3M™ es resistente y se ha diseñado para respaldar a nuestros discos de fibra en amoladoras de ángulo recto. Nuestros soportes de goma dura funcionan bien con diferentes placas frontales de 3M. Maximizan los discos abrasivos, reduciendo las vibraciones y los golpes. Fíjelos de forma segura a las amoladoras con una tuerca de sujeción*. * Se vende por separado.

Ref.	Código	Medida mm	€ / u.
21003103	7000061711	115	22,09
21003104	7000061712	125	23,22



Discos Scotch-Brite Bristle (BD-ZB)



Mineral Cubitron™ I • Soporte fibra • Materiales: INOX, Acero • Máquinas: Amoladora angular.

Ref.	Código	Medida mm	Color	Grano	€/ u.
8003238	7100138287	115	Verde	P-50	44,05
8003239	7100138288	115	Amarillo	P-80	44,05
8003240	7100138289	115	Blanco	P-120	44,05



Disco de láminas POLIFAN A SG STEELOX (acero + inox)



Elevado rendimiento de lijado y muy larga duración. Proceso de trabajo más rápido y alta rentabilidad gracias al gran rendimiento de rectificación. Menos cambios de herramienta gracias a su larga vida útil. Materiales: Acero e INOX Aplicaciones: Desbaste de superficies y eliminación de soldadura. Abrasivo: Corindón A PFC: forma cónica; PFF: forma plana.

Ref.	Código	Ø	Ø Agujero mm	r.p.m. máx.	grano	Forma	€/ u.
438800	PFC 115 A 40 SG STEELOX	115	22,2	13.300	A 40	Cónico	6,40
438801	PFC 125 A 40 SG STEELOX	125	22,2	12.200	A 40	Cónico	6,64
438802	PFC 180 A 40 SG STEELOX	180	22,2	8.500	A 40	Cónico	10,88
438803	PFF 115 A 40 SG STEELOX	115	22,2	13.300	A 40	Plano	6,40
438804	PFF 125 A 40 SG STEELOX	125	22,2	12.200	A 40	Plano	6,64
438805	PFF 180 A 40 SG STEELOX	180	22,2	8.500	A 40	Plano	10,88
438900	PFC 115 A 60 SG STEELOX	115	22,2	13.300	A 60	Cónico	6,40
438901	PFC 125 A 60 SG STEELOX	125	22,2	12.200	A 60	Cónico	6,64
438902	PFC 180 A 60 SG STEELOX	180	22,2	8.500	A 60	Cónico	10,88
438903	PFF 115 A 60 SG STEELOX	115	22,2	13.300	A 60	Plano	6,40
438904	PFF 125 A 60 SG STEELOX	125	22,2	12.200	A 60	Plano	6,64
438905	PFF 180 A 60 SG STEELOX	180	22,2	8.500	A 60	Plano	10,88
439100	PFC 115 A 120 SG STEELOX	115	22,2	13.300	A 120	Cónico	6,40
439101	PFC 125 A 120 SG STEELOX	125	22,2	12.200	A 120	Cónico	6,64
439102	PFC 180 A 120 SG STEELOX	180	22,2	8.500	A 120	Cónico	10,88
439103	PFF 115 A 120 SG STEELOX	115	22,2	13.300	A 120	Plano	6,40
439104	PFF 125 A 120 SG STEELOX	125	22,2	12.200	A 120	Plano	6,64
439105	PFF 180 A 120 SG STEELOX	180	22,2	8.500	A 120	Plano	10,88



04

Disco de láminas POLIFAN A-COOL SG INOX + ALU (inox + aluminio)



Muy adecuados para el amolado frío en materiales malos conductores de calor, como el acero inoxidable (INOX) y el aluminio. Menor aportación de calor a la pieza que con otros discos de láminas lijadoras. Gracias al recubrimiento activo del abrasivo, este no se emboza, por ejemplo, cuando se trabaja sobre aluminio blando. Materiales: INOX, aluminio y otros metales no férricos Aplicaciones: Desbaste de superficies, eliminación de soldadura, canteado y desbarbado. Abrasivo: Corindón A con recubrimiento refrigerante activo [COOL] Para aluminio, utilizar solo los granos 40 y 60. PFC: forma cónica; PFF: forma plana.

Ref.	Código	Ø	Ø Agujero mm	r.p.m. máx.	Grano	Forma	€/ u.
439200	PFC 115 A-COOL 40 SG INOX+ALU	115	22,2	13.300	A-COOL 40	Cónico	6,91
439201	PFC 125 A-COOL 40 SG INOX+ALU	125	22,2	12.200	A-COOL 40	Cónico	7,16
439202	PFC 180 A-COOL 40 SG INOX+ALU	180	22,2	8.500	A-COOL 40	Cónico	11,74
439203	PFF 115 A-COOL 40 SG INOX+ALU	115	22,2	13.300	A-COOL 40	Plano	6,91
439204	PFF 125 A-COOL 40 SG INOX+ALU	125	22,2	12.200	A-COOL 40	Plano	7,16
439205	PFF 180 A-COOL 40 SG INOX+ALU	180	22,2	8.500	A-COOL 40	Plano	11,74
439300	PFC 115 A-COOL 60 SG INOX+ALU	115	22,2	13.300	A-COOL 60	Cónico	6,91
439301	PFC 125 A-COOL 60 SG INOX+ALU	125	22,2	12.200	A-COOL 60	Cónico	7,16
439302	PFC 180 A-COOL 60 SG INOX+ALU	180	22,2	8.500	A-COOL 60	Cónico	11,74
439303	PFF 115 A-COOL 60 SG INOX+ALU	115	22,2	13.300	A-COOL 60	Plano	6,91
439304	PFF 125 A-COOL 60 SG INOX+ALU	125	22,2	12.200	A-COOL 60	Plano	7,16
439305	PFF 180 A-COOL 60 SG INOX+ALU	180	22,2	8.500	A-COOL 60	Plano	11,74
439400	PFC 115 A-COOL 80 SG INOX+ALU	115	22,2	13.300	A-COOL 80	Cónico	6,91
439401	PFC 125 A-COOL 80 SG INOX+ALU	125	22,2	12.200	A-COOL 80	Cónico	7,16
439402	PFC 180 A-COOL 80 SG INOX+ALU	180	22,2	8.500	A-COOL 80	Cónico	11,74
439403	PFF 115 A-COOL 80 SG INOX+ALU	115	22,2	13.300	A-COOL 80	Plano	6,91
439404	PFF 125 A-COOL 80 SG INOX+ALU	125	22,2	12.200	A-COOL 80	Plano	7,16
439405	PFF 180 A-COOL 80 SG INOX+ALU	180	22,2	8.500	A-COOL 80	Plano	11,74



Disco de láminas plano 969F de Cubitron™ II



Soporte de poliéster resistente • Mineral Cubitron™ II • Para trabajos intensivos de media y alta presión.

Ref.	Código	Medida mm	Grano	€ / u.
8003166	7100105859	115	P-40	6,41
8003167	7100105860	115	P-60	6,41
8003168	7100105861	115	P-80	6,41
8003169	7100105862	125	P-40	7,37
8003170	7100105863	125	P-60	7,37
8003171	7100105864	125	P-80	7,37
8003172	7100105865	180	P-40	13,50
8003173	7100105866	180	P-60	13,50
8003174	7100105867	180	P-80	13,50



Disco de láminas POLIFAN Z SG POWER STEELOX (acero + inox)



Rendimiento de lijado agresivo y excelente duración, logrando la máxima rentabilidad. Es el mejor disco de láminas lijadoras convencional para acero. Proceso de trabajo más rápido y máxima rentabilidad gracias al alto rendimiento de arranque. Máxima agresividad durante toda la vida útil. Menos cambios de herramienta gracias a su excelente duración. Materiales: Acero e INOX Aplicaciones: Eliminación de soldadura, canteado y desbarbado Abrasivo: Corindón de circonio Z PFC: forma cónica; PFF: forma plana.

Ref.	Código	Ø	Ø Agujero mm	r.p.m. máx.	Grano	Forma	€ / u.
439600	PFC 115 Z 40 SG-POWER STEELOX	115	22,2	13.300	Z 40	Cónico	6,85
439601	PFC 125 Z 40 SG-POWER STEELOX	125	22,2	12.200	Z 40	Cónico	7,50
439602	PFC 180 Z 40 SG-POWER STEELOX	180	22,2	8.500	Z 40	Cónico	12,29
439603	PFF 115 Z 40 SG POWER STEELOX	115	22,2	13.300	Z 40	Plano	6,85
439604	PFF 125 Z 40 SG POWER STEELOX	125	22,2	12.200	Z 40	Plano	7,50
439605	PFF 180 Z 40 SG POWER STEELOX	180	22,2	8.500	Z 40	Plano	12,29
439700	PFC 115 Z 60 SG POWER STEELOX	115	22,2	13.300	Z 60	Cónico	6,85
439701	PFC 125 Z 60 SG POWER STEELOX	125	22,2	12.200	Z 60	Cónico	7,50
439702	PFC 180 Z 60 SG POWER STEELOX	180	22,2	8.500	Z 60	Cónico	12,29
439703	PFF 115 Z 60 SG POWER STEELOX	115	22,2	13.300	Z 60	Plano	6,85
439704	PFF 125 Z 60 SG POWER STEELOX	125	22,2	12.200	Z 60	Plano	7,50
439705	PFF 180 Z 60 SG POWER STEELOX	180	22,2	8.500	Z 60	Plano	12,29



Disco de láminas Sistema X-LOCK POLIFAN Z SG POWER STEELOX (acero + inox)



Los discos de láminas lijadoras POLIFAN Z SG POWER convencen por su rendimiento de lijado agresivo y su excelente duración, logrando la máxima rentabilidad. Es el mejor disco de láminas lijadoras convencional para acero. Con el sistema X-LOCK para amoladoras angulares se puede cambiar la herramientas rápida y cómodamente. En el sistema X-LOCK, en vez de ser redondo, el agujero tiene forma de x y ello permite fijar y ajustar la herramienta a la amoladora angular. Esto garantiza que diferentes herramientas se fijen de forma segura muy rápidamente.

Ref.	Código	Ø mm	Fijación	r.p.m. máx.	Grano	Forma	Fijación	€ / u.
21091023	PFC 125 Z 40 SG POWER STEELOX/X-LOCK	125	Sistema X-LOCK	12.200	Z 40	Cónico	X-LOCK	8,54
21091024	PFC 125 Z 60 SG POWER STEELOX/X-LOCK	125	Sistema X-LOCK	12.200	Z 60	Cónico	X-LOCK	8,54
21091025	PFC 125 Z 80 SG POWER STEELOX/X-LOCK	125	Sistema X-LOCK	12.200	Z 80	Cónico	X-LOCK	8,54



3M™ Disco de láminas 769F Plano



El disco de láminas 3M™ 769F es nuestro duradero disco de láminas abrasivo de alto rendimiento con resistente soporte de poliéster y tecnología de grano de precisión 3M™.

Ref.	Código	Medida mm	Grano	€/ u.
21003129	7100196819	115	120+	4,08
21003130	7100196540	115	40+	4,08
21003131	7100196817	115	60+	4,08
21003132	7100196820	115	80+	4,08
21003133	7100196821	125	120+	4,65
21003134	7100196813	125	40+	4,65
21003135	7100196799	125	60+	4,65
21003136	7100196790	180	80+	4,65
21003137	7100196792	180	120+	7,86
21003138	7100196538	180	40+	7,86
21003139	7100196800	180	60+	7,86
21003140	7100197431	125	80+	7,86



Disco de láminas POLIFAN CO-COOL SG STEELOX (acero + inox)



Herramienta especial de grano cerámico para trabajos de lijado exigentes sobre materiales malos conductores de calor. Ejecución PFERD con amolado especialmente frío, arranque de virutas agresivo y gran rentabilidad. El grano cerámico tiene efecto de autoafilado por lo que no es necesario ejercer mucha presión al trabajar. Los mejores resultados se obtienen con máquinas propulsoras potentes. PFC: Forma cónica. PFF: Forma plana.

Ref.	Código	Ø	Fijación	r.p.m. máx.	Grano	Forma	€/ u.
408900	PFC 115 CO-COOL 40 SG STEELOX	115	Sistema X-LOCK	13.300	CO-COOL 40	Cónico	7,68
408901	PFC 125 CO-COOL 40 SG STEELOX	125	Sistema X-LOCK	12.200	CO-COOL 40	Cónico	7,95
408902	PFC 180 CO-COOL 40 SG STEELOX	180	Sistema X-LOCK	8.500	CO-COOL 40	Cónico	13,59
408903	PFF 115 CO-COOL 40 SG STEELOX	115	Sistema X-LOCK	13.300	CO-COOL 40	Plano	7,68
408904	PFF 125 CO-COOL 40 SG STEELOX	125	Sistema X-LOCK	12.200	CO-COOL 40	Plano	7,95
408905	PFF 180 CO-COOL 40 SG STEELOX	180	Sistema X-LOCK	8.500	CO-COOL 40	Plano	13,59



Disco de láminas POLIFAN Z SGP CURVE STEELOX (acero + inox)



Corindón de zirconio. Para acero e inox. Su original forma radial es ideal para el desbaste de cordones de soldadura en ángulo.

Ref.	Código	Ø	Fijación	Ancho cordón angular	r.p.m. máx.	grano	€/ u.
414350	PFR 115-M Z 40 SGP CURVE STEELOX	115	Sistema X-LOCK	>5 mm	13.300	40	13,20
414351	PFR 115-L Z 40 SGP CURVE STEELOX	115	Sistema X-LOCK	>8 mm	13.300	40	13,20
414300	PFR 125-M Z 40 SGP CURVE STEELOX	125	Sistema X-LOCK	>5mm	12.200	40	13,36
414301	PFR 125-L Z 40 SGP CURVE STEELOX	125	Sistema X-LOCK	>8mm	12.200	40	13,36



04



Disco de láminas



Adecuados para el lijado de superficies, canteado y eliminación de cordones de soldadura. Disponibles en dos tipos de grano: GRANO CORINDÓN A: universal. Lleva un recubrimiento especial para un lijado frío sobre acero inoxidable. GRANO CORINDÓN DE CIRCONIO Z: para acero y acero inoxidable. Muy agresivo sobre todo para el canteado y eliminación de soldadura.

Ref.	Código	Ø	Ø Agujero mm	r.p.m. máx.	grano	€/ u.
8004878	69398084	115	22,2	13.300	A60	3,78
8004879	69398085	115	22,2	13.300	A80	3,78
8004880	69398119	115	22,2	13.300	A40	3,78
8004881	69398120	125	22,2	12.200	A40	3,93
8004882	69398121	125	22,2	12.200	A60	3,93
8004883	69398122	125	22,2	12.200	A80	3,93
8004884	69398175	115	22,2	13.300	Z40	3,21
8004885	69398176	115	22,2	13.300	Z60	3,18
8004886	69398177	115	22,2	13.300	Z80	3,15
2400780	40037515	125	22,2	12.200	Z40	3,45
2400781	40037516	125	22,2	12.200	Z60	3,45
2400782	40037517	125	22,2	12.200	Z80	3,45



Disco de láminas POLIFAN CO SGP CURVE STEELOX (acero + inox)



Óxido cerámico. Para inox y acero. El abrasivo de óxido cerámico garantiza un desbaste muy frío en materiales malos conductores de calor logrando unos resultados óptimos sin calentar ni dañar la pieza de trabajo. Su original forma radial es ideal para el desbaste de cordones de soldadura en ángulo.

Ref.	Código	Ø	Fijación	Ancho cordón angular	r.p.m. máx.	grano	€/ u.
427000	PFR 115-M CO 60 SGP CURVE STEELOX	115	Sistema X-LOCK	>5 mm	13.300	60	15,23
427001	PFR 115-L CO 60 SGP CURVE STEELOX	115	Sistema X-LOCK	>8 mm	13.300	60	15,23
427002	PFR 125-M CO 60 SGP CURVE STEELOX	125	Sistema X-LOCK	>5 mm	12.200	60	15,48
427003	PFR 125-L CO 60 SGP CURVE STEELOX	125	Sistema X-LOCK	>8 mm	12.200	60	15,48



Disco de láminas POLIFAN A SGP CURVE ALU (aluminio)



Para aluminio y metales no férricos. La herramienta no se emboza, incluso al trabajar sobre materiales blandos y lubricados. No contiene aditivos que puedan dejar rastros indeseados en la pieza de trabajo. Por lo tanto la superficie se puede soldar directamente. Su original forma radial es ideal para el desbaste de cordones de soldadura en ángulo.

Ref.	Código	Ø	Fijación	Ancho cordón angular	r.p.m. máx.	grano	€/ u.
427500	PFR 115-L A 40 SGP CURVE ALU	115	Sistema X-LOCK	>8 mm	13.300	40	14,77
427501	PFR 125-L A 40 SGP CURVE ALU	125	Sistema X-LOCK	>8 mm	12.200	40	15,04



Disco de láminas Sistema X-LOCK POLIFAN Z PSF STEELOX (acero + inox)



Discos de láminas lijadoras POLIFAN con rendimiento de lijado agresivo y buena duración. Con el sistema X-LOCK para amoladoras angulares se puede cambiar la herramienta rápida y cómodamente. En el sistema X-LOCK, en vez de ser redondo, el agujero tiene forma de x y ello permite fijar y ajustar la herramienta a la amoladora angular. Esto garantiza que diferentes herramientas se fijen de forma segura muy rápidamente.

Ref.	Código	Ø mm	Fijación	r.p.m. máx.	Grano	Forma	€/ u.
21091014	PFC 115 Z 40 PSF STEELOX/X-LOCK	115	Sistema X-LOCK	13.300	Z 40	Cónico	5,82
21091015	PFC 115 Z 60 PSF STEELOX/X-LOCK	115	Sistema X-LOCK	13.300	Z 60	Cónico	5,82
21091016	PFC 115 Z 80 PSF STEELOX/X-LOCK	115	Sistema X-LOCK	13.300	Z 80	Cónico	5,82
21091017	PFC 125 Z 40 PSF STEELOX/X-LOCK	125	Sistema X-LOCK	12.200	Z 40	Cónico	6,31
21091018	PFC 125 Z 60 PSF STEELOX/X-LOCK	125	Sistema X-LOCK	12.200	Z 60	Cónico	6,31
21091019	PFC 125 Z 80 PSF STEELOX/X-LOCK	125	Sistema X-LOCK	12.200	Z 80	Cónico	6,31



Disco de láminas cónico 969F de Cubitron™ II



Soporte de poliéster resistente • Mineral Cubitron™ II • Para trabajos intensivos de media y alta presión.



Ref.	Código	Medida mm	Grano	€/u.
8003177	7100105849	115	P-80	6,41
8003180	7100105852	125	P-80	7,37
8003181	7100105853	150	P-40	10,68
8003182	7100105854	150	P-60	10,68
8003183	7100105855	150	P-80	10,68
8003186	7100105858	180	P-80	13,50

Ref.	Código	Medida mm	Grano	€/u.
8003175	7100105847	115	P-40	6,41
8003176	7100105848	115	P-60	6,41
8003178	7100105850	125	P-40	7,37
8003179	7100105851	125	P-60	7,37
8003184	7100105856	180	P-40	13,50
8003185	7100105857	180	P-60	13,50

3M™ Cubitron™ II disco de láminas 967A, cónico



El disco de láminas 967A 3M™ Cubitron™ II brinda excelentes tasas de corte en aplicaciones de presión baja a media-alta. Nuestros discos son ideales para superficies planas o fuera del borde de trabajo, especialmente donde el acabado final y no dejar marcas es importante.



Ref.	Código	Medida mm	Grano	€/u.
21003110	7000104359	115	40+	6,86
21003111	7000104360	115	60+	6,86
21003112	7000104361	115	80+	6,86
21003113	7100011310	125	40+	7,13
21003114	7100011144	125	60+	7,13

Ref.	Código	Medida mm	Grano	€/u.
21003115	7100011569	125	80+	7,13
21003117	7000104365	180	40+	11,85
21003118	7000104366	180	60+	11,85
21003119	7000104367	180	80+	11,85

Disco de láminas de vellón



Para todo tipo de aplicaciones, desde lijado basto a lijado fino, en industria y taller. Para obtener un rendimiento óptimo, utilizar a una velocidad de corte recomendada de 30-35 m/s. Abrasivo: Corindón A Tamaños de grano POLIVLIES disponibles: 100 G = basto (marrón claro); 180 M = medio (marrón rojizo); 240 F = fino (azul)

Ref.	Código	Ø Agujero mm	Ø x espesor mm	r.p.m. máx.	grano	€/u.
434800	PVL 115 A 100 G	22,2	115 x 18	13.300	Basto	12,32
434801	PVL 125 A 100 G	22,2	125 x 18	12.200	Basto	15,24
434900	PVL 115 A 180 M	22,2	115 x 18	13.300	Medio	11,48
434901	PVL 125 A 180 M	22,2	125 x 18	12.200	Medio	14,20
435000	PVL 115 A 240 F	22,2	115 x 18	13.300	Fino	10,96
435001	PVL 125 A 240 F	22,2	125 x 18	12.200	Fino	13,70



Disco de láminas de vellón Sistema X-LOCK



Para todo tipo de aplicaciones, desde lijado basto a lijado fino, en industria y taller. Con el sistema X-LOCK para amoladoras angulares se puede cambiar la herramienta rápida y cómodamente. En el sistema X-LOCK, en vez de ser redondo, el agujero tiene forma de x y ello permite fijar y ajustar la herramienta a la amoladora angular. Esto garantiza que diferentes herramientas se fijen de forma segura muy rápidamente.



Ref.	Código	Fijación	Ø x espesor mm	r.p.m. máx.	Grano	€/ u.
21091000	PVL 115-X-LOCK A 100 G	Sistema X-LOCK	115 x 18	13.300	100 Basto	13,29
21091001	PVL 115-X-LOCK A 180 M	Sistema X-LOCK	115 x 18	13.300	180 Medio	12,45
21091002	PVL 115-X-LOCK A 240 F	Sistema X-LOCK	115 x 18	13.300	240 Fino	11,83
21091003	PVL 125-X-LOCK A 100 G	Sistema X-LOCK	125 x 18	12.200	100 Basto	16,52
21091004	PVL 125-X-LOCK A 180 M	Sistema X-LOCK	125 x 18	12.200	180 Medio	15,34
21091005	PVL 125-X-LOCK A 240 F	Sistema X-LOCK	125 x 18	12.200	240 Fino	14,81

3M™ Disco de láminas 769F Cónico



El disco de láminas 3M™ 769F es nuestro duradero disco de láminas abrasivo de alto rendimiento con resistente soporte de poliéster y tecnología de grano de precisión 3M™.



Ref.	Código	Medida mm	Grano	€/ u.	Ref.	Código	Medida mm	Grano	€/ u.
21003141	7100196539	115	120+	4,08	21003147	7100196797	125	60+	4,65
21003142	7100196818	115	40+	4,08	21003148	7100196791	125	80+	4,65
21003143	7100196816	115	60+	4,08	21003149	7100196793	180	120+	7,86
21003144	7100196789	115	80+	4,08	21003150	7100197061	180	40+	7,86
21003145	7100196815	125	120+	4,65	21003151	7100196798	180	60+	7,86
21003146	7100196812	125	40+	4,65	21003152	7100196794	180	80+	7,86

Disco de láminas PFC 115 Z50 SG POWER STEELOX (acero + inox)



Rendimiento de lijado agresivo y excelente duración, logrando la máxima rentabilidad. Es el mejor disco de láminas lijadoras convencional para acero. Proceso de trabajo más rápido y máxima rentabilidad gracias al alto rendimiento de arranque. Máxima agresividad durante toda la vida útil. Menos cambios de herramienta gracias a su excelente duración. Materiales: Acero e INOX Aplicaciones: Eliminación de soldadura, canteado y desbarbado Abrasivo: Corindón de circonio Z PFC: forma cónica; PFF: forma plana. El tamaño de grano 50 ofrece una proporción óptima entre duración y agresividad.



Ref.	Código	Ø	Ø Agujero mm	r.p.m. máx.	Grano	Forma	€/ u.
2400783	PFC 115 Z50 SG POWER STEELOX	115	22,2	13.300	Z 50	Cónico	6,85
2400784	PFC 125 Z50 SG POWER STEELOX	125	22,2	12.200	Z 50	Cónico	7,50
2400785	PFF 115 Z50 SG POWER STEELOX	115	22,2	13.300	Z 50	Plano	6,85
2400786	PFF 125 Z50 SG POWER STEELOX	125	22,2	12.200	Z 50	Plano	7,50
2400787	PFF 180 Z50 SG POWER STEELOX	180	22,2	8.500	Z 50	Plano	12,29

Disco de láminas PFC 115 Z 40 PSF TRIM STEELOX



Disco de láminas lijadoras POLIFAN PFC 115x22,23 mm cónico Z40 línea universal PSF TRIM STEELOX acero/acero inoxidable. Con soporte de nylon.

Ref.	Código	Ø	Fijación	r.p.m. máx.	Grano	Soporte	Forma	€/ u.
2400788	PFC 115 Z 40 PSF TRIM STEELOX	115	Sistema X-LOCK	13.300	Z 40	Nylon	Cónico	4,84
2400789	PFC 115 Z 60 PSF TRIM STEELOX	115	Sistema X-LOCK	13.300	Z 60	Nylon	Cónico	4,84
2400790	PFC 115 Z 80 PSF TRIM STEELOX	115	Sistema X-LOCK	13.300	Z 80	Nylon	Cónico	4,84
2400791	PFC 125 Z 40 PSF TRIM STEELOX	125	Sistema X-LOCK	12.200	Z 40	Nylon	Cónico	5,23
2400792	PFC 125 Z 60 PSF TRIM STEELOX	125	Sistema X-LOCK	12.200	Z 60	Nylon	Cónico	5,23
2400793	PFC 125 Z 80 PSF TRIM STEELOX	125	Sistema X-LOCK	12.200	Z 80	Nylon	Cónico	5,23



Disco de diamante- Expert



Hasta 2 veces más preciso que el disco de diamante para cerámica Bosch 2607019473./ Corte limpio y de alta calidad con la tecnología Bosch Diamond Technology../ Con orificio de 10 mm para mini amoladora../ Ideal para realizar cortes limpios y rectos en baldosas cerámicas; cortar azulejos en baños y cocinas, así como baldosas de pavimento de las que se utilizan en terrazas, jardines y también en interiores../ Lo mejor para los alicatadores: máxima precisión y acabado de calidad.

Ref.	Código	Ø	Ø Agujero mm	Ancho de corte mm	€/ u.
2400794	2608900652	76	10	1.5	24,20
2400795	2608900656	85	22,2	1.6	27,92
2400796	2608900657	115	22,2	1.4	48,09
2400797	2608900658	125	22,2	1.4	55,85



04

Disco de diamante- Expert



Dura hasta 4 veces más que el disco de diamante Multi Material Bosch 2608615028./ Aristas de corte excepcionalmente duraderas empleando tecnología Bosch Diamond Technology../ Haz clic con X-LOCK, el sistema de cambio de accesorios más rápido del mercado. También se adapta a amoladoras con tuercas y roscas../ Ideal para cortar materiales de construcción, como ladrillos y hormigón armado; realizar cortes rectos en losas de pavimento; cortar ladrillos a medida para los trabajos de albañilería; cortar materiales utilizados habitualmente en la construcción de viviendas../ Lo mejor para los trabajadores de la construcción: larga duración y elevada versatilidad.

Ref.	Código	Ø	Ø Agujero mm	Ancho de corte mm	€/ u.
2400798	2608900669	115	22,2	2.4	68,26
2400799	2608900670	125	22,2	2.4	80,67



Disco de tronzar fino PSF buena prestación - STEEL (acero)



Disco de corte para acero, con gran rendimiento de corte y buena duración. Corte fino y sin rebabas. Comodidad y seguridad. Proceso de trabajo más rápido gracias a su elevado rendimiento de corte. Alta rentabilidad gracias a su larga vida útil. Materiales: Acero Aplicaciones: Corte de chapas, perfiles y material macizo, formación de aberturas Abrasivo: Corindón A

Ref.	Código	Ø x espesor mm	Ø Agujero mm	r.p.m. máx.	€/ u.
409600	EHT 115-1,0 PSF STEEL	115 x 1,0	22,2 (7/8")	13.300	2,35
409601	EHT 115-1,6 PSF STEEL	115 x 1,6	22,2 (7/8")	13.300	2,35
409602	EHT 125-1,0 PSF STEEL	125 x 1,0	22,2 (7/8")	12.200	2,63
409603	EHT 125-1,6 PSF STEEL	125 x 1,6	22,2 (7/8")	12.200	2,63
409604	EHT 180-1,6 PSF STEEL	180 x 1,6	22,2 (7/8")	8.600	3,69
409605	EHT 230-1,9 PSF STEEL	230 x 1,9	22,2 (7/8")	6.600	4,43



Disco de tronzar fino PSF buena prestación - ALU + STONE (aluminio + piedra)



Disco de corte para metales no férricos y materiales minerales, con gran rendimiento de corte y larga duración. Proceso de trabajo mas rápido gracias a su elevado rendimiento de corte. Alta rentabilidad gracias a su larga vida útil. El espesor de 1,0 mm también es ideal para amoladoras angulares de batería. Materiales: Aluminio, titanio, otros metales no férricos, piedra, hormigón, azulejos, duroplásticos, duroplásticos reforzados con fibra (PRFV: fibra de vidrio / PRFC: fibra de carbono) y fundición. Aplicaciones: Corte de chapas, perfiles y material macizo, formación de aberturas Abrasivo: Carburo de silicio C



Ref.	Código	Ø x espesor mm	Ø Agujero mm	r.p.m. máx.	€ / u.
409700	EHT 115-1,0 PSF ALU+STONE	115 x 1,0	22,2 (7/8")	13.300	2,47
409701	EHT 115-1,6 PSF ALU+STONE	230 x 1,6	22,2 (7/8")	13.300	2,47

Disco de tronzar fino PSF buena prestación - STEELOX (acero + inox)



Disco de corte para acero y acero inoxidable (INOX), con gran rendimiento de corte y buena duración. Proceso de trabajo mas rápido gracias a su elevado rendimiento de corte. Alta rentabilidad gracias a su larga vida útil. Los discos de corte finos son ideales para amoladoras angulares de batería. Materiales: Acero e INOX Aplicaciones: Corte de chapas, perfiles y material macizo, formación de aberturas Abrasivo: Corindón A Proceso de trabajo mas rápido gracias a su elevado rendimiento de corte. Alta rentabilidad gracias a su larga vida útil. Materiales: Acero Aplicaciones: Corte de chapas, perfiles y material macizo, formación de aberturas Abrasivo: Corindón A



Ref.	Código	Ø x espesor mm	Ø Agujero mm	r.p.m. máx.	€ / u.
409900	EHT 115-1,0 PSF STEELOX	115 x 1,0	22,2 (7/8")	13.300	2,41
409901	EHT 115-1,6 PSF STEELOX	115 x 1,6	22,2 (7/8")	13.300	2,41
409902	EHT 125-1,0 PSF STEELOX	125 x 1,0	22,2 (7/8")	12.200	2,70
409903	EHT 125-1,6 PSF STEELOX	125 x 1,6	22,2 (7/8")	12.200	2,70
409904	EHT 150-1,6 PSF STEELOX	150 x 1,6	22,2 (7/8")	10.200	3,38
409905	EHT 180-1,6 PSF STEELOX	180 x 1,6	22,2 (7/8")	8.600	3,76
409906	EHT 230-1,9 PSF STEELOX	230 x 1,9	22,2 (7/8")	6.600	4,51
2400800	EHT 230-1,9 PSF HD STEELOX	230 x 1,9	22,2 (7/8")	6.600	4,59

Disco de corte de Silver plano



• Mineral óxido de aluminio cerámico • Tipo 41 (plano) • Tecnología 3M PSG, para cortes rápidos y mayor vida útil del disco • Resultados óptimos a bajas presiones de trabajo • Válido tanto para aceros al carbono como inoxidables • Materiales: INOX, Acero • Máquinas: Rectificadora.

Ref.	Código	Medida mm Ø	Espesor mm	€ / u.
8003123	7100139227	115	1	2,21
8003124	7100139229	115	1,6	2,46
8003125	7100139232	125	1	2,71
8003126	7100139234	125	1,6	2,71
8003127	7100139238	125	2	2,71
8003128	7100139235	150	1,6	3,71
8003130	7100139240	180	2	4,77
8003131	7100141045	180	3	5,89
8003133	7100141075	230	3	7,83



Disco de tronzar fino Sistema X-LOCK SG alto rendimiento - STEELOX (acero + inox)



Disco de corte para acero, con gran rendimiento de corte y máxima duración. Corte fino y sin rebabas. Comodidad y seguridad. Proceso de trabajo mas rápido gracias a su elevado rendimiento de corte. Máxima rentabilidad gracias a su vida útil extraordinariamente larga. Materiales: Acero Aplicaciones: Corte de chapas, perfiles y material macizo, formación de aberturas Abrasivo: Corindón de alto rendimiento A



Ref.	Código	Ø x espesor mm	Ø Agujero mm	r.p.m. máx.	€/ u.
410001	EHT 115-1,0 SG STEEL	115 x 1,0	22,2 (7/8")	13.300	3,32
410002	EHT 115-1,6 SG STEEL	115 x 1,6	22,2 (7/8")	13.300	3,32
410003	EHT 125-1,0 SG STEEL	125 x 1,0	22,2 (7/8")	12.200	3,74
410004	EHT 125-1,6 SG STEEL	125 x 1,6	22,2 (7/8")	12.200	3,74
410005	EHT 180-1,6 SG STEEL	180 x 1,6	22,2 (7/8")	8.600	5,34
410006	EHT 230-1,9 SG STEEL	230 x 1,9	22,2 (7/8")	6.600	6,86

Disco de tronzar fino Sistema X-LOCK PSF alto rendimiento - STEELOX (acero + inox)



Disco de corte para acero y acero inoxidable (INOX), con gran rendimiento de corte y buena duración. Con el sistema X-LOCK para amoladoras angulares se puede cambiar la herramientas rápida y cómodamente. En el sistema X-LOCK, en vez de ser redondo, el agujero tiene forma de x y ello permite fijar y ajustar la herramienta a la amoladora angular. Esto garantiza que diferentes herramientas se fijen de forma segura muy rápidamente.



Ref.	Código	Ø x espesor mm	Fijación	r.p.m. máx.	€/ u.
21091026	EHT 115-1,0 PSF STEELOX/X-LOCK	115 x 1,0	Sistema X-LOCK	13.300	2,89
21091027	EHT 115-1,6 PSF STEELOX/X-LOCK	115 x 1,6	Sistema X-LOCK	13.300	2,89
21091028	EHT 125-1,0 PSF STEELOX/X-LOCK	125 x 1,0	Sistema X-LOCK	12.200	3,23
21091029	EHT 125-1,6 PSF STEELOX/X-LOCK	125 x 1,6	Sistema X-LOCK	12.200	3,23

Disco de tronzar fino Sistema X-LOCK SG alto rendimiento - STEELOX (acero + inox)



Disco de corte para acero y acero inoxidable (INOX), con un rendimiento de corte muy alto y máxima duración. Con el sistema X-LOCK para amoladoras angulares se puede cambiar la herramientas rápida y cómodamente. En el sistema X-LOCK, en vez de ser redondo, el agujero tiene forma de x y ello permite fijar y ajustar la herramienta a la amoladora angular. Esto garantiza que diferentes herramientas se fijen de forma segura muy rápidamente.



Ref.	Código	Ø x espesor mm	Fijación	r.p.m. máx.	€/ u.
21091034	EHT 125-1,0 SG STEELOX/X-LOCK	125 x 1,0	Sistema X-LOCK	12.200	4,60
21091035	EHT 125-1,6 SG STEELOX/X-LOCK	125 x 1,6	Sistema X-LOCK	12.200	4,60

Disco de corte de Silver centro hundido



• Mineral óxido de aluminio cerámico • Tipo 41 (plano) • Tecnología 3M PSG, para cortes rápidos y mayor vida útil del disco • Resultados óptimos a bajas presiones de trabajo • Válido tanto para aceros al carbono como inoxidables • Materiales: INOX, Acero • Máquinas: Rectificadora.



Ref.	Código	Medida mm Ø	Espesor mm	€/ u.
8003134	7100141056	115	2	2,71
8003135	7100141069	125	2,5	3,25
8003136	7100141067	180	2,5	5,71
8003137	7100141070	230	2,5	7,28

Disco de tronzar fino SG alto rendimiento - inox



Disco de corte para acero inoxidable [INOX], con un rendimiento de corte muy alto y máxima duración. Corte fino y sin rebabas. Comodidad y seguridad. Proceso de trabajo mas rápido gracias a su elevado rendimiento de corte. Máxima rentabilidad gracias a su vida útil extraordinariamente larga. Materiales: INOX Aplicaciones: Corte de chapas, perfiles y material macizo, formación de aberturas Abrasivo: Corindón de alto rendimiento A

Ref.	Código	Ø x espesor mm	Fijación	r.p.m. máx.	€ / u.
410101	EHT 115-1,0 SG STEELOX	115 x 1,0	Sistema X-LOCK	13.300	3,38
410102	EHT 115-1,6 SG STEELOX	115 x 1,6	Sistema X-LOCK	13.300	3,38
410103	EHT 125-1,0 SG STEELOX	125 x 1,0	Sistema X-LOCK	12.200	3,83
410104	EHT 125-1,6 SG STEELOX	125 x 1,6	Sistema X-LOCK	12.200	3,83
410105	EHT 150-1,6 SG STEELOX	150 x 1,6	Sistema X-LOCK	10.200	5,09
410106	EHT 180-1,6 SG STEELOX	180 x 1,6	Sistema X-LOCK	8.600	5,43
410107	EHT 230-1,9 SG STEELOX	230 x 1,9	Sistema X-LOCK	6.600	7,02



Disco de tronzar SG alto rendimiento - STEELOX (acero + inox)



Disco de corte para acero y acero inoxidable [INOX], con un rendimiento de corte muy alto y máxima duración. Proceso de trabajo mas rápido gracias a su elevado rendimiento de corte. Máxima rentabilidad gracias a su vida útil extraordinariamente larga. Materiales: Acero e INOX Aplicaciones: Corte de chapas, perfiles y material macizo, formación de aberturas Abrasivo: Corindón de alto rendimiento A

Ref.	Código	Ø x espesor mm	Fijación	r.p.m. máx.	€ / u.
410200	EHT 115-2,4 SG STEELOX	115 x 2,4	Sistema X-LOCK	13.300	3,32
410201	EH 115-2,4 SG STEELOX	115 x 2,4	Sistema X-LOCK	13.300	3,32
410202	EH 115-3,2 SG STEELOX	115 x 3,2	Sistema X-LOCK	13.300	3,32
410203	EHT 125-2,4 SG STEELOX	125 x 2,4	Sistema X-LOCK	12.200	3,68
410204	EH 125-2,4 SG STEELOX	125 x 2,4	Sistema X-LOCK	12.200	3,68
410205	EH 125-3,2 SG STEELOX	125 x 3,2	Sistema X-LOCK	12.200	3,68
410206	EHT 180-2,5 SG STEELOX	180 x 2,5	Sistema X-LOCK	8.600	4,96
410207	EH 180-2,5 SG STEELOX	180 x 2,5	Sistema X-LOCK	8.600	4,96
410210	EHT 230-3,2 SG STEELOX	230 x 3,2	Sistema X-LOCK	6.600	6,89



Disco de tronzar Sistema X-LOCK SG alto rendimiento - STEELOX (acero + inox)



Disco de corte para acero y acero inoxidable [INOX], con un rendimiento de corte muy alto y máxima duración. Con el sistema X-LOCK para amoladoras angulares se puede cambiar la herramientas rápida y cómodamente. En el sistema X-LOCK, en vez de ser redondo, el agujero tiene forma de x y ello permite fijar y ajustar la herramienta a la amoladora angular. Esto garantiza que diferentes herramientas se fijen de forma segura muy rápidamente.

Ref.	Código	Ø x espesor mm	Fijación	r.p.m. máx.	€ / u.
21091037	EH 125-2,4 SG STEELOX/X-LOCK	125 x 2,4	Sistema X-LOCK	12.200	4,41



Disco de corte de Cubitron™ 3 Plano



El disco de corte 3M™ Cubitron™ 3 crea cortes perpendiculares utilizando el borde exterior del disco, lo que lo hace ideal para cortar metal, como chapa metálica de carrocería o de uso naval, tuberías de acero inoxidable, tubos de escape, abrazaderas y fijaciones oxidadas, entre otros.

Ref.	Código	Ø mm	Espesor mm	€ / u.
2400801	7100303999	180	2	13,07
2400802	7100304120	115	1	4,54
2400803	7100304306	125	1	4,97
2400804	7100303998	230	2	18,72
2400805	7100303997	230	2,5	20,48
2400806	7100303832	230	3	23,47



Disco de corte de Cubitron™ II Centro hundido



El disco de corte 3M™ Cubitron™ 3 crea cortes perpendiculares utilizando el borde exterior del disco, lo que lo hace ideal para cortar metal, como chapa metálica de carrocería o de uso naval, tuberías de acero inoxidable, tubos de escape, abrazaderas y fijaciones oxidadas, entre otros.

Además, el disco de corte 3M™ Cubitron™ 3 cuenta con la tecnología de grano PSG con un nuevo diseño de 3M que emplea innovaciones patentadas con tecnología de unión molecular diseñada con estructuras afiladas y angulares que se fracturan continuamente para crear puntas afiladas. Estas puntas limpias y afiladas ayudan a crear un abrasivo que corta de forma más rápida, genera menos calor y dura mucho más que los abrasivos convencionales.

Los abrasivos de alto rendimiento 3M™ Cubitron™ están diseñados para profesionales que necesitan obtener un mayor rendimiento de sus equipos. Si elige el disco de corte 3M™ Cubitron™ 3, disfrutará de la próxima generación de abrasivos de alto rendimiento.



Ref.	Código	Ø mm	Espesor mm	€/ u.
2400807	7100303831	125	3	6,52
2400808	7100303996	115	2,5	6,29
2400809	7100303995	125	2,5	6,43
2400810	7100303994	180	2,5	15,77
2400811	7100303993	230	2,5	20,48

Disco de tronzar SG alto rendimiento - STEEL (acero)



Disco de corte para acero, con gran rendimiento de corte y máxima duración. Proceso de trabajo mas rápido gracias a su elevado rendimiento de corte. Máxima rentabilidad gracias a su vida útil extraordinariamente larga. Materiales: Acero Aplicaciones: Corte de chapas, perfiles y material macizo, formación de aberturas Abrasivo: Corindón de alto rendimiento A

Ref.	Código	Ø x espesor mm	Fijación	r.p.m. máx.	€/ u.
409800	EHT 100-2,4 SG STEEL/16,0	100 x 2,4	Sistema X-LOCK	15.200	3,58
409801	EH 100-2,4 SG STEEL/16,0	100 x 2,4	Sistema X-LOCK	15.200	3,58
409802	EHT 115-2,4 SG STEEL	115 x 2,4	Sistema X-LOCK	13.300	3,23
409803	EH 115-2,4 SG STEEL	115 x 2,4	Sistema X-LOCK	13.300	3,23
409804	EH 115-3,2 SG STEEL	115 x 3,2	Sistema X-LOCK	13.300	3,23
409805	EHT 125-2,4 SG STEEL	125 x 2,4	Sistema X-LOCK	12.200	3,63
409806	EH 125-2,4 SG STEEL	125 x 2,4	Sistema X-LOCK	12.200	3,63
409807	EH 125-3,2 SG STEEL	125 x 3,2	Sistema X-LOCK	12.200	3,63
409808	EHT 150-3,0 SG STEEL	150 x 3,0	Sistema X-LOCK	10.200	4,45
409809	EH 150-3,0 SG STEEL	150 x 3,0	Sistema X-LOCK	10.200	4,45
409810	EHT 180-2,9 SG STEEL	180 x 2,9	Sistema X-LOCK	8.600	4,88
409811	EH 180-2,9 SG STEEL	180 x 2,9	Sistema X-LOCK	8.600	4,88
409812	EHT 180-3,2 SG STEEL	180 x 3,2	Sistema X-LOCK	8.600	4,88
409813	EH 180-3,2 SG STEEL	180 x 3,2	Sistema X-LOCK	8.600	4,88
409814	EHT 230-2,9 SG STEEL	230 x 2,9	Sistema X-LOCK	6.600	6,76
409815	EH 230-2,9 SG STEEL	230 x 2,9	Sistema X-LOCK	6.600	6,76
409816	EHT 230-3,2 SG STEEL	230 x 3,2	Sistema X-LOCK	6.600	6,76
409817	EH 230-3,2 SG STEEL	230 x 3,2	Sistema X-LOCK	6.600	6,76



Disco de tronzar SG alto rendimiento - CAST + ALU (fundición + aluminio)



Discos de corte optimizados para el uso exigente en la fundición y en talleres de desbarbado, con elevado rendimiento de corte, larga duración y gran estabilidad lateral. El refuerzo de tejido para el uso exigente en fundición garantiza la máxima seguridad. Proceso de trabajo mas rápido gracias a su elevado rendimiento de corte. Alta rentabilidad gracias a su larga vida útil. Materiales: Fundición gris, fundición nodular (GG/GJL, GGG/GJS) y aleaciones de aluminio duras Abrasivo: Corindón especial A y carburo de silicio C



Ref.	Código	Ø x espesor mm	Fijación	r.p.m. máx.	€/ u.
410400	EH 230-3,2 SG CAST+ALU	230 x 3,2	Sistema X-LOCK	6.600	8,52

Disco de tronzar SG alto rendimiento - CAST + INOX (fundición + inox)



Discos de corte optimizados para el uso exigente en la fundición y en talleres de desbarbado, con elevado rendimiento de corte, larga duración y gran estabilidad lateral. El refuerzo de tejido para el uso exigente en fundición garantiza la máxima seguridad. Proceso de trabajo mas rápido gracias a su elevado rendimiento de corte. Alta rentabilidad gracias a su larga vida útil. Materiales: Fundición, INOX y acero fundido Abrasivo: Corindón especial A

Ref.	Código	Ø x espesor mm	Fijación	r.p.m. máx.	€ / u.
410600	EHT 230-2,9 SG CAST+INOX	230 x 2,9	Sistema X-LOCK	6.600	9,41
410601	EH 230-2,9 SG CAST+INOX	230 x 2,9	Sistema X-LOCK	6.600	9,41



Disco de tronzar para máquinas estacionarias SG alto rendimiento - acero/fundición



Los discos de corte estacionarios PFERD se diseñan, se fabrican y se prueban con las máximas exigencias de calidad. El corte con abrasivo es uno de los métodos de corte más eficiente y rentable y se utiliza en: - Trenes de laminación - Fundiciones - Construcción de maquinaria - Fabricación de acero - Mantenimiento de railes - Forjas y ajustes de forja - Laboratorios

Ref.	Código	Ø x espesor mm	Fijación	r.p.m. máx.	€ / u.
410700	80 T 300-4 A24 SG/22,2	300 x 4	Sistema X-LOCK	6.400	8,90
410701	80 T 300-4 A24 SG/25,4	300 x 4	Sistema X-LOCK	6.400	8,90
410702	80 T 300-4 A24 SG/32,0	300 x 4	Sistema X-LOCK	6.400	8,90



Disco de tronzar SG alto rendimiento - ALU (metales no férricos, aluminio)



Disco de corte para aluminio y otros metales no férricos, con un rendimiento de corte muy alto y máxima duración. La mezcla especial de abrasivos y la tecnología de aglomerante impiden que el disco de corte se emboce, incluso con aluminio blando y tenaz. Proceso de trabajo mas rápido gracias a su elevado rendimiento de corte. Máxima rentabilidad gracias a su vida útil extraordinariamente larga. No contiene materiales de relleno que dejen restos no deseados en la pieza. Por tanto, la superficie se puede soldar directamente. Materiales: Aluminio y otros metales no férricos Aplicaciones: Corte de chapas, perfiles y material macizo, formación de aberturas Abrasivo: Corindón de alto rendimiento A y carburo de silicio C

Ref.	Código	Ø x espesor mm	Fijación	r.p.m. máx.	€ / u.
410508	EHT 115-1,0 SG ALU	115 x 1,0	Sistema X-LOCK	13.300	3,50
410509	EHT 115-1,6 SG ALU	115 x 1,6	Sistema X-LOCK	13.300	3,50
410510	EHT 125-1,0 SG ALU	125 x 1,0	Sistema X-LOCK	12.200	4,27
410511	EHT 125-1,6 SG ALU	125 x 1,6	Sistema X-LOCK	12.200	4,27
410512	EHT 180-1,6 SG ALU	180 x 1,6	Sistema X-LOCK	8.600	5,60



Disco de tronzar Sistema X-LOCK PSF buena prestación - STEELOX (acero + inox)



Disco de corte para acero y acero inoxidable (INOX), con gran rendimiento de corte y buena duración. Con el sistema X-LOCK para amoladoras angulares se puede cambiar la herramientas rápida y cómodamente. En el sistema X-LOCK, en vez de ser redondo, el agujero tiene forma de x y ello permite fijar y ajustar la herramienta a la amoladora angular. Esto garantiza que diferentes herramientas se fijen de forma segura muy rápidamente.

Ref.	Código	Ø x espesor mm	Fijación	r.p.m. máx.	€ / u.
21091031	EH 125-2,4 PSF STEELOX/X-LOCK	125 x 2,4	Sistema X-LOCK	12.200	3,08



Disco combinado de corte y desbaste DUODISC



Disco combinado de corte y desbaste DUODISC, centro embutido. Línea universal PSF DUO STEELOX para acero e inox. Nueva construcción de disco con un rendimiento de corte muy mejorado, mayor duración y rapidez comparado con los discos de corte habituales del mercado. Además son 100% seguros para el desbaste.



Ref.	Código	Ø x espesor mm	Sistema X-LOCK	Forma	€/ u.
2400812	E 115-1,9 PSF DUO STEELOX	115 x 1,9	r.p.m. máx.	Embutido	3,61
2400813	E 125-1,9 PSF DUO STEELOX	125 x 1,9	r.p.m. máx.	Embutido	3,69

Disco de corte para acero e inox



Alta velocidad de corte y elevado tiempo de aplicación. Baja formación de rebaba. Orificio normal 22,23 mm. Para el mecanizado de chapas y perfiles de pared fina.



Ref.	Código	Ejecución	Ø x grosor mm	Velocidad máx.	€/ u.
8004887	69198166	Embutido	115 x 2,4	13.300	1,26
8004888	69198167	Embutido	125 x 2,4	12.200	1,32
8004889	69198168	Embutido	178 x 2,5	8.600	2,25
8004890	69198169	Embutido	230 x 2,5	6.600	3,18
8004891	69198243	Plano	115 x 1,6	13.300	1,59
8004892	69198244	Plano	125 x 1,6	12.200	1,77
40037512	69198277	Plano con anillo	115 x 1,0	13.300	1,59
8004894	69198278	Plano	125 x 1,0	12.200	1,77
40037514	69901617	Plano	230 x 2,0	6.600	3,24

04

Disco de desbaste PSF buena prestación - STEEL (acero)



Disco de desbaste para acero, con gran rendimiento y buena duración. Proceso de trabajo más rápido y alta rentabilidad gracias a las buenas propiedades de rectificadas. Larga vida útil. Adecuado también para amoladoras angulares de poca potencia. Desbaste suave, simplemente con una ligera presión se logra un gran arranque de virutas. Materiales: Acero y fundición Aplicaciones: Desbaste de superficies, eliminación de soldadura, mecanizado de cordones en ángulo, trabajo sobre juntas, canteado y desbarbado Abrasivo: Corindón A



Ref.	Código	Ø x espesor mm	Fijación	r.p.m. máx.	€/ u.
410802	E 115-7 PSF STEEL	115 x 7,2	Sistema X-LOCK	13.300	3,18
410803	E 125-7 PSF STEEL	125 x 7,2	Sistema X-LOCK	12.200	3,76
2400814	E 180-7 PSF STEEL	180 x 7,2	r.p.m. máx.		5,02
410805	E 180-8 PSF STEEL	180 x 8,3	Sistema X-LOCK	8.600	6,23
410806	E 230-7 PSF STEEL	230 x 7,2	Sistema X-LOCK	6.600	8,00
410807	E 230-8 PSF STEEL	230 x 8,3	Sistema X-LOCK	6.600	9,88

Disco de desbaste PSF buena prestación Sistema X-LOCK - STEEL (acero)



Disco de desbaste para acero, con gran rendimiento y buena duración. Con el sistema X-LOCK para amoladoras angulares se puede cambiar la herramienta rápida y cómodamente. En el sistema X-LOCK, en vez de ser redondo, el agujero tiene forma de x y ello permite fijar y ajustar la herramienta a la amoladora angular. Esto garantiza que diferentes herramientas se fijen de forma segura muy rápidamente.



Ref.	Código	Ø x espesor mm	Fijación	r.p.m. máx.	€/ u.
21091040	E 115-7 PSF STEEL/X-LOCK	115 x 7,2	Sistema X-LOCK	13.300	3,83
21091041	E 125-7 PSF STEEL/X-LOCK	125 x 7,2	Sistema X-LOCK	12.200	4,50

Disco de desbaste Silver



Óxido de aluminio con tecnología PSG [Precision Shaped Grain] - Tejido sin tejer - Materiales: INOX, Acero
- Máquinas: Amoladora angular.

Ref.	Código	Ø mm	Espesor mm	€/ u.
8003192	7100141083	115	7	4,24
8003193	7100141086	125	7	4,45
8003194	7100141089	150	7	7,23
8003195	7100141096	180	7	8,00
8003196	7100141099	230	7	12,01



Disco de desbaste para acero e inox



Adecuados para el desbaste de superficies, canteado y eliminación de cordones de soldadura en acero y acero inoxidable. Agujero 22,23 mm.

Ref.	Código	Ejecución	Ø x grosor mm	Velocidad máx.	€/ u.
8004895	69220589	Embutido	115 x 7,2	13.300	2,40
8004896	69220590	Embutido	125 x 7,2	12.200	2,64
8005556	69198286	Embutido	150 x 7,2	12.200	4,23
8004897	69198044	Embutido	178 x 7,2	8.500	5,76
8004898	69198045	Embutido	230 x 7,2	6.600	3,75



Disco de desbaste PSF buena prestación - STEELOX (acero + inox)



Disco de desbaste para acero y acero inoxidable (INOX), con gran rendimiento y buena duración. Uso universal en acero y acero inoxidable (INOX). Proceso de trabajo más rápido y alta rentabilidad gracias a las buenas propiedades de rectificadas. Larga vida útil. Adecuado también para amoladoras angulares de poca potencia. Desbaste suave, simplemente con una ligera presión se logra un gran arranque de virutas. Materiales: Acero e INOX Aplicaciones: Desbaste de superficies, eliminación de soldadura, mecanizado de cordones en ángulo, trabajo sobre juntas, canteado y desbarbado Abrasivo: Corindón A Espesor 4,1 mm óptimo para el desbaste de soldaduras en ángulo.

Ref.	Código	Ø x espesor mm	Fijación	r.p.m. máx.	€/ u.
410900	E 100-6 PSF STEELOX/16,0	100 x 6,3	Sistema X-LOCK	15.200	3,22
410901	E 115-7 PSF STEELOX	115 x 7,2	Sistema X-LOCK	13.300	3,28
410902	E 125-7 PSF STEELOX	125 x 7,2	Sistema X-LOCK	12.200	3,87
410903	E 150-7 PSF STEELOX	150 x 7,2	Sistema X-LOCK	10.200	4,67
410904	E 180-7 PSF STEELOX	180 x 7,2	Sistema X-LOCK	8.600	5,15
410905	E 230-7 PSF STEELOX	230 x 7,2	Sistema X-LOCK	6.600	8,49
411101	E 115-4,1 PSF STEELOX	115 x 4,1	Sistema X-LOCK	13.300	3,26
411105	E 180-4,1 PSF STEELOX	180 x 4,1	Sistema X-LOCK	8.600	5,11
411107	E 180-8 PSF STEELOX	180 x 8,3	Sistema X-LOCK	8.600	6,39
411109	E 230-8 PSF STEELOX	230 x 8,3	Sistema X-LOCK	6.600	10,21



Disco de desbaste SG alto rendimiento - STEEL (acero)



Disco de desbaste para acero, con alto rendimiento y muy buena duración. Proceso de trabajo más rápido y máxima rentabilidad gracias a las buenas propiedades de rectificadas. Menos cambios de herramienta gracias a su larga vida útil. Materiales: Acero Aplicaciones: Desbaste de superficies, eliminación de soldadura, mecanizado de cordones en ángulo, trabajo sobre juntas, canteado y desbarbado Abrasivo: Corindón especial A Espesor 4,1 mm óptimo para el desbaste de soldadura de raíz.

Ref.	Código	Ø x espesor mm	Fijación	r.p.m. máx.	€/ u.
411201	E 115-4,1 SG STEEL	115 x 4,1	Sistema X-LOCK	13.300	3,86
411202	E 115-7 SG STEEL	115 x 7,2	Sistema X-LOCK	13.300	4,00
411203	E 125-4,1 SG STEEL	125 x 4,1	Sistema X-LOCK	12.200	4,77
411204	E 125-7 SG STEEL	125 x 7,2	Sistema X-LOCK	12.200	4,93
411205	E 150-7 SG STEEL	150 x 7,2	Sistema X-LOCK	10.200	5,50
411206	E 180-4,1 SG STEEL	180 x 4,1	Sistema X-LOCK	8.600	5,81
411208	E 180-7 SG STEEL	180 x 7,2	Sistema X-LOCK	8.600	6,38
411209	E 180-8 SG STEEL	180 x 8,3	Sistema X-LOCK	8.600	8,00
411210	E 230-7 SG STEEL	230 x 7,2	Sistema X-LOCK	6.600	10,05
411211	E 230-8 SG STEEL	230 x 8,3	Sistema X-LOCK	6.600	12,09



Disco de desbaste SG alto rendimiento - CAST + STONE (fundición + piedra)



Disco de desbaste optimizado para el uso en fundición y talleres de desbarbado, para hierro fundido (también: costra de fundición) y aleaciones de aluminio duras, con alto rendimiento y larga duración. Proceso de trabajo muy rápido y alta rentabilidad gracias a las buenas propiedades de rectificado. Vida útil muy larga. Materiales: Fundición, costra de fundición, hormigón y aleaciones de aluminio duras Aplicaciones: Desbaste de superficies, canteado y desbarbado Abrasivo: Carburo de silicio C



Ref.	Código	Ø x espesor mm	Ø Agujero mm	r.p.m. máx.	€/ u.
411500	E 115-7 SG CAST+STONE	115 x 7,2	22,2 (7/8")	13.300	4,32
411501	E 125-7 SG CAST+STONE	125 x 7,2	22,2 (7/8")	12.200	5,28
411502	E 180-7 SG CAST+STONE	180 x 7,2	22,2 (7/8")	8.600	6,88
411503	E 230-7 SG CAST+STONE	230 x 7,2	22,2 (7/8")	6.600	11,04

Disco de desbaste SG alto rendimiento - INOX (inox)



Disco de desbaste para acero inoxidable (INOX), con alto rendimiento y muy buena duración. Desbaste suave y frío sobre acero inoxidable (INOX). Proceso de trabajo más rápido y máxima rentabilidad gracias a las buenas propiedades de rectificado. Menos cambios de herramienta gracias a su larga vida útil. Materiales: INOX Aplicaciones: Desbaste de superficies, eliminación de soldadura, mecanizado de cordones en ángulo, trabajo sobre juntas, canteado y desbarbado Abrasivo: Corindón especial A Los espesores 4,1 y 5,2 mm son óptimos para el desbaste de soldaduras en ángulo



Ref.	Código	Ø x espesor mm	Ø Agujero mm	r.p.m. máx.	€/ u.
411000	E 115-4,1 SG INOX	115 x 4,1	22,2 (7/8")	13.300	3,94
411002	E 115-7 SG INOX	115 x 7,2	22,2 (7/8")	13.300	4,25
411003	E 125-4,1 SG INOX	125 x 4,1	22,2 (7/8")	12.200	4,91
411004	E 125-5,2 SG INOX	125 x 5,2	22,2 (7/8")	12.200	4,99
411005	E 125-7 SG INOX	125 x 7,2	22,2 (7/8")	12.200	5,08
411006	E 180-4,1 SG INOX	180 x 4,1	22,2 (7/8")	8.600	5,89
411007	E 180-7 SG INOX	180 x 7,2	22,2 (7/8")	8.600	6,75
411008	E 180-8 SG INOX	180 x 8,3	22,2 (7/8")	8.600	8,27
411009	E 230-7 SG INOX	230 x 7,2	22,2 (7/8")	6.600	10,37
411010	E 230-8 SG INOX	230 x 8,3	22,2 (7/8")	6.600	12,44

Disco de desbaste SG alto rendimiento - CAST + ALU (fundición + aluminio)



Disco de desbaste optimizado para el uso en fundición y talleres de desbarbado, para hierro fundido y aluminio, con un rendimiento muy alto y una larga duración. Proceso de trabajo muy rápido y alta rentabilidad gracias a las buenas propiedades de rectificado. Vida útil muy larga. Materiales: Fundición gris y nodular (GG/GJL, GGG/GJS), costra de fundición con inclusiones de arena e incrustaciones y aleaciones de aluminio duras Aplicaciones: Desbaste de superficies, canteado y desbarbado Abrasivo: Corindón especial A y carburo de silicio C



Ref.	Código	Ø x espesor mm	Ø Agujero mm	r.p.m. máx.	€/ u.
411300	E 180-7 SG CAST+ALU	180 x 7,2	22,2 (7/8")	8.600	9,69
411301	E 230-7 SG CAST+ALU	230 x 7,2	22,2 (7/8")	6.600	12,08

Disco de desbaste SG alto rendimiento - ZIRKON CAST + STEEL (fundición + acero)



Disco de desbaste de corindón de circonio optimizado para el uso en fundición y talleres de desbarbado, para hierro fundido y acero, con un rendimiento excelente y una duración muy larga. Proceso de trabajo muy rápido y alta rentabilidad gracias a las buenas propiedades de rectificado. Vida útil muy larga. Materiales: Fundición gris y nodular (GG/GJL, GGG/GJS) y acero Aplicaciones: Desbaste de superficies, eliminación de soldadura, mecanizado de cordones en ángulo, trabajo sobre juntas, canteado y desbarbado Abrasivo: Corindón de circonio Z y corindón especial A Los espesores 4,1 y 5,2 mm son óptimos para el desbaste de soldadura de raíz.



Ref.	Código	Ø x espesor mm	Ø Agujero mm	r.p.m. máx.	€/ u.
411303	E 180-7 ZIRKON SG CAST+STEEL	180 x 7,2	22,2 (7/8")	8.600	8,99
411304	E 180-8 ZIRKON SG CAST+STEEL	180 x 8,3	22,2 (7/8")	8.600	10,33
411305	E 230-4,1 ZIRKON SG CAST+STEEL	230 x 4,1	22,2 (7/8")	6.600	11,57
411306	E 230-5,2 ZIRKON SG CAST+STEEL	230 x 5,2	22,2 (7/8")	6.600	11,84
411307	E 230-7 ZIRKON SG CAST+STEEL	230 x 7,2	22,2 (7/8")	6.600	12,08

Disco de desbaste Cubitron™ II



Cubitron™ II • Tipo T27 • Tecnología 3M PSG para cortes super rápidos y una mayor vida útil del disco • Versatil, se puede utilizar como disco de desbaste o como disco de corte indistintamente • Válido para aceros al carbono y aceros inoxidables, para corte, resanados, biselados, eliminación de muescas y soldaduras fillet.



Ref.	Código	Ø mm	Espesor mm	€/ u.
8003187	7100074406	115	7	9,58
8003188	7100074405	125	7	9,98
8003189	7100074524	150	7	12,88

Disco de desbaste Cubitron™ 3



El disco de desbaste con centro hundido 3M™ Cubitron™ 3 es una muela rígida de larga duración y de corte excepcionalmente rápido para la eliminación de soldaduras voluminosas y otras aplicaciones de desbaste intensivo. Gracias a su centro hundido, que permite el desbaste en cualquier ángulo, este disco funciona bien en casi todos los materiales y está especialmente formulado para su uso en acero inoxidable, acero templado y aleaciones de uso aeroespacial.

Además, el disco de desbaste con centro hundido 3M™ Cubitron™ 3 cuenta con la tecnología de grano PSG con un nuevo diseño de 3M que emplea innovaciones patentadas con tecnología de unión molecular diseñada con estructuras afiladas y angulares que se fracturan continuamente para crear puntas afiladas. Estas puntas limpias y afiladas ayudan a crear un abrasivo que corta de forma más rápida, genera menos calor y dura mucho más que los abrasivos convencionales. Los abrasivos de alto rendimiento 3M™ Cubitron™ están hechos para profesionales que necesitan obtener un mayor rendimiento de su equipo. Si elige el disco de desbaste con centro hundido 3M™ Cubitron™ 3, disfrutará de la próxima generación de abrasivos de alto rendimiento.



Ref.	Código	Ø mm	Espesor mm	€/ u.
2400815	7100303980	178	7	17,74
2400816	7100303979	230	7	24,50
2400817	7100303975	115	4,2	9,06
2400818	7100303974	125	4,2	9,61
2400819	7100303973	150	4,2	11,42
2400820	7100303972	180	4,2	15,30
2400821	7100303971	230	4,2	24,07

3M™ Cubitron™ II Discos de desbaste flexibles



El disco de desbaste flexible 3M™ Cubitron™ II está diseñado para ayudarle a desbastar, dar forma y lijar lo más rápido posible en una amplia variedad de materiales metálicos. Utiliza el grano de forma precisa PSG de 3M, que corta de forma rápida y cómoda, y ofrece mayor flexibilidad.

Ref.	Código	Medida mm	Espesor mm	Grano	€/ u.
21003153	7100140055	100	3	36+	3,13
21003154	7100140056	115	3	A36	3,83
21003155	7100140059	115	3	A80	3,83
21003156	7100140060	125	3	A80	5,47
21003157	7100140057	125	3	A36	4,41
21003158	7100140058	180	3	A36	11,30



Disco de desbaste SG alto rendimiento - ALU (metales no férricos, aluminio)



Disco de desbaste para aluminio y otros metales no férricos, con alto rendimiento y muy buena duración. El disco de desbaste no se emboza sobre materiales blandos y untuosos. Proceso de trabajo más rápido y máxima rentabilidad gracias a las buenas propiedades de rectificado. Menos cambios de herramienta gracias a su larga vida útil. No contiene materiales de relleno que dejen restos no deseados en la pieza. Por tanto, la superficie se puede soldar directamente. Materiales: Aluminio y otros metales no férricos. Aplicaciones: Desbaste de superficies, eliminación de soldadura, mecanizado de cordones en ángulo, trabajo sobre juntas, canteado y desbarbado. Abrasivo: Corindón especial A y carburo de silicio C



Ref.	Código	Ø x espesor mm	Ø Agujero mm	r.p.m. máx.	€/ u.
411400	E 115-7 SG ALU	115 x 7,2	22,2 (7/8")	13.300	4,95
411401	E 125-7 SG ALU	125 x 7,2	22,2 (7/8")	12.200	5,90
411402	E 180-7 SG ALU	180 x 7,2	22,2 (7/8")	8.600	7,86
411403	E 230-7 SG ALU	230 x 7,2	22,2 (7/8")	6.600	12,02

DISCO DESBASTE CERAMIC SGP STEELOX



Disco de desbaste E 115x7,2x22,23 mm CERAMIC línea gran exigencia SGP STEELOX para acero y acero inoxidable. Máximo rendimiento con grano cerámico para un desbaste rápido y económico.



Ref.	Código	Ø x espesor mm	Ø Agujero mm	r.p.m. máx.	Forma	€/ u.
2400822	E 115-7 CERAMIC SGP STEELOX	115 x 7,2	22,2 (7/8")	13.300	Embutido	8,40
2400823	E 125-7 CERAMIC SGP STEELOX	125 x 7,2	22,2 (7/8")	12.200	Embutido	9,23
2400824	E 150-7 CERAMIC SGP STEELOX	150 x 7,2	22,2 (7/8")	10.200	Embutido	11,32
2400825	E 180-7 CERAMIC SGP STEELOX	180 x 7,2	22,2 (7/8")	8.500	Embutido	14,43
2400826	E 230-7 CERAMIC SGP STEELOX	230 x 7,2	22,2 (7/8")	6.600	Embutido	21,52

CC-GRIND-ROBUST SGP STEELOX



Disco de desbaste CC-GRIND-ROBUST, línea especial SGP STEELOX para acero y acero inoxidable con grano VICTOGRAIN. Es 3 veces más rápido que un disco de desbaste tradicional y genera muchas menos vibraciones, polvo y ruido. También deja una mejor calidad de superficie.



Ref.	Código	Ø mm	22,2 (7/8")	Grano	€/ u.
2400827	CC-GRIND-ROBUST 115 SGP STEELOX	115	r.p.m. máx.	VICTOGRAIN	6,00

CC-GRIND-ROBUST SGP STEELOX



Disco de desbaste CC-GRIND-ROBUST, línea especial SGP STEELOX para acero y acero inoxidable con grano VICTOGRAIN. Es 3 veces más rápido que un disco de desbaste tradicional y genera muchas menos vibraciones, polvo y ruido. También deja una mejor calidad de superficie.



Ref.	Código	Ø mm	22,2 (7/8")	Grano	€/ u.
2400828	CC-GRIND-ROBUST 125 SGP STEELOX	125	r.p.m. máx.	VICTOGRAIN	6,66

Discos de desbaste CC-GRIND® SOLID

Para trabajos de desbaste duros y exigentes. Esta versión mejorada del innovador disco CC-GRIND® de PFERD se caracteriza por el plato de fibra de vidrio integrado, combinado con un grano abrasivo de alto rendimiento y un sistema de sujeción y de refrigeración patentado. La estructura innovadora y excepcionalmente resistente del plato de fibra de vidrio garantiza una utilización robusta y segura, como si se tratara de un disco de desbaste. El disco de desbaste CC-GRIND®-SOLID cumple todos los requisitos de seguridad de un disco de desbaste conforme con la norma DIN EN 12413, especialmente la prueba de resistencia lateral. El ruido y las vibraciones se reducen a la mitad, y la generación del polvo en un 80%. Gracias a su especial sistema de fijación el disco queda perfectamente alineado pudiendo usarse de forma eficiente en plano.

Ventajas:

- Estructura por capas: estructura de la herramienta muy resistente, para un trabajo seguro y ergonómico.
- Trabajos de desbaste duros y exigentes: plato de fibra de vidrio integrado para trabajos duros y exigentes, apto también para el mecanizado de cantos.
- Sistema de fijación especial: cambio de herramienta rápido y sencillo.
- El sistema de fijación permite un uso extremadamente plano y el aprovechamiento óptimo del abrasivo disponible.

PFERDERGONOMICS® recomienda los discos de desbaste CC-GRIND®-SOLID para reducir de manera permanente la generación de ruido y vibraciones y mejorar así la comodidad en el trabajo.



CC-GRIND SOLID, Ejecución - STEEL (acero)

Con el CC-GRIND-SOLID, PFERD ofrece una alternativa moderna, potente y ergonómica al disco de desbaste. Ventajas: - Proceso de trabajo más rápido gracias al abrasivo altamente agresivo. - Mucho más ergonómico que el disco de desbaste: el ruido y las vibraciones se reducen un 50%, y el polvo un 80%. - La estructura del soporte de fibra de vidrio garantiza un uso igual de robusto y seguro que con un disco de desbaste. - Calidad de superficie claramente superior que con los discos de desbaste convencionales. Materiales: Acero Aplicaciones: Desbaste de superficies, eliminación de soldadura, canteado y desbarbado Para lograr un rendimiento óptimo, utilizar de forma plana y con el juego de bridas de fijación SFS CC-GRIND. Utilizar solo con la superficie. No es adecuado para el amolado periférico.



Ref.	Código	Ø mm	Juego de bridas de fijación adecuado	€ / u.
411425	CC-GRIND-SOLID 115 SG STEEL	115	SFS CC-GRIND-SOLID 115/125 M14	5,93
411426	CC-GRIND-SOLID 125 SG STEEL	125	SFS CC-GRIND-SOLID 115/125 M14	6,53
411427	CC-GRIND-SOLID 150 SG STEEL	150	SFS CC-GRIND-SOLID 150/180 M14	8,52
411428	CC-GRIND-SOLID 180 SG STEEL	180	SFS CC-GRIND-SOLID 150/180 M14	11,95



CC-GRIND SOLID, Ejecución INOX

Con el CC-GRIND-SOLID, PFERD ofrece una alternativa moderna, potente y ergonómica al disco de desbaste. Ventajas: - Proceso de trabajo más rápido gracias al abrasivo altamente agresivo. - Mucho más ergonómico que el disco de desbaste: el ruido y las vibraciones se reducen un 50%, y el polvo un 80%. - La estructura del soporte de fibra de vidrio garantiza un uso igual de robusto y seguro que con un disco de desbaste. - Calidad de superficie claramente superior que con los discos de desbaste convencionales. Materiales: Inox Aplicaciones: Eliminación de soldadura, canteado y desbarbado Para lograr un rendimiento óptimo, utilizar de forma plana y con el juego de bridas de fijación SFS CC-GRIND. Utilizar solo con la superficie. No es adecuado para el amolado periférico.



Ref.	Código	Ø mm	Juego de bridas de fijación adecuado	€ / u.
411430	CC-GRIND-SOLID 115 SG INOX	115	SFS CC-GRIND-SOLID 115/125 M14	6,53
411431	CC-GRIND-SOLID 125 SG INOX	125	SFS CC-GRIND-SOLID 115/125 M14	7,18
411432	CC-GRIND-SOLID 180 SG INOX	180	SFS CC-GRIND-SOLID 150/180 M14	13,15

Juegos de bridas CC-GRIND SOLID



Con el juego de bridas de fijación CC-GRIND, los CC-GRIND SOLID quedan perfectamente alineados en la carcasa protectora de la amoladora angular. Los discos se pueden usar de forma especialmente plana, consiguiendo así un trabajo más eficiente. La pieza de soporte negra se coloca en la brida de montaje original de la amoladora angular. La tuerca plateada sustituye a la brida de apriete de la herramienta.

Ref.	Código	Adecuado para máquinas de tipo	Rosca	€/ u.
411435	SFS CC-GRIND 115/125 M14	Amoladora angular 115 / 125 y rosca M14	M14	7,94
411436	SFS CC-GRIND 150/180 M14	Amoladora angular 150 / 180 y rosca M14	M14	7,94



Cepillo circular, ondulado modelo CT



Ref.	Código	Ø exterior mm	Nº Hileras	Ancho mm	Multijeje mm	Material	€/ u.
414711	CT1005E99	100	5	16		Acero Latonado 0,30 E	16,99
414717	CT1205E99	125	5	19		Acero Latonado 0,30 E	18,49
414723	CT1505E99	150	5	20		Acero Latonado 0,30 E	19,48
414729	CT1705E99	175	5	20		Acero Latonado 0,30 E	22,73
414735	CT2005E99	200	5	20		Acero Latonado 0,30 E	26,11
414741	CT2205E99	225	5	22		Acero Latonado 0,30 E	42,03
414747	CT2505E99	250	5	25	13-16- 20-22- 26-30- 50-13- 16-20- 22-26- 30-50	Acero Latonado 0,30 E	42,80
415111	CT 1005Z99	100	5	16		Acero Inox. 0,30 Z	34,49
415117	CT 1205Z99	125	5	19		Acero Inox. 0,30 Z	41,90
415123	CT 1505Z99	150	5	20		Acero Inox. 0,30 Z	42,92
415135	CT 2005Z99	200	5	20		Acero Inox. 0,30 Z	89,40
415141	CT 2205Z99	225	5	22		Acero Inox. 0,30 Z	125,31
415147	CT 2505Z99	250	5	25		Acero Inox. 0,30 Z	126,83

Cepillo circular ondulado modelo CT con casquillo roscado



Características Técnicas: Diseñados para trabajar de forma individual con amplias posibilidades de dimensiones y ejes. Aplicaciones CT: Eliminación de óxidos, pinturas, cascarillas, rebabas, etc. Limpieza de piedras de fundición, recauchutado. Tratamiento de superficies metálicas, caucho, plásticos, madera, vidrio, etc.

Ref.	Código	Diámetro exterior mm	Hileras	Ancho mm	Rosca	Material	€/ u.
8001199	CT1205EM14	120	5	20	M14		20,41
8001200	CT1505EM14	150	5	20	M14	Acero Latonado 0,30 mm E	21,42
8001201	CT1705EM14	175	5	20	M14		24,68



Cepillo encapsulado gama tipo CT



Características Técnicas: *El recubrimiento de caucho protege la oxidación del alambre. * Control total sobre la superficie a cepillar. * El cepillado en ranuras, en componentes de geometrías complejas es ahora más sencillo. * El caucho que recubre el alambre se degrada de forma regular obteniendo así un alto rendimiento de la herramienta. * Desaparecen las proyecciones de acero. * Mayor rendimiento que un cepillo de monofilamento estándar *Mejora la manipulación, evitando pinchazos al usuario. Aplicaciones: * Ideal para eliminar cascarilla en los cordones de soldadura. *Para el sector OIL&GAS * Cepillado de aristas. *Adecuado para trabajos en ambientes marinos



Ref.	Código	Diámetro Exterior mm	Saliente mm (d)	Ancho (mm)	Casquillos Roscados (e)	Material	€ / u.
8001124	ENC1501FM14	150	27,5	6	M14-M10	Acero Latonado 0,35 mm F	41,96
8001125	ENC1701FM14	175	40	6	w 5/8"		45,61

Cepillo Radial Bristle BB-ZB Tipo



Mineral Cubitron™ I - Soporte termoplástico - Materiales: INOX, Acero, Madera
 - Máquinas: Motor de bancada, Amoladora recta.



A (púas rectas orientadas)

Ref.	Código	Medida mm	Grano	€ / u.
8003212	7100138290	150	P-36	103,96
8003213	7100138347	150	P-50	110,35
8003214	7100138291	150	P-80	110,88

Tipo C (púas curvas)

Ref.	Código	Medida mm	Grano	€ / u.
8003218	7100138300	150	P-80	106,73
8003219	7100138298	150	P-120	106,82
8003220	7100138299	150	P-220	106,82
8003226	7100138335	200	P-220	166,21
8003221	7000021284	150	P-400	106,82
8003222	7000046180	150	6 mic.	106,82
8003223	7000046181	150	1 mic.	100,85
8003224	7100138337	200	P-80	209,93
8003225	7100138338	200	P-120	211,49

Tipo S (púas rectas)

Ref.	Código	Medida mm	Grano	€ / u.
8003215	7100138332	200	P-50	236,35
8003216	7100138333	200	P-80	236,35
8003217	7100138334	200	P-120	218,06

Carda POLISCRATCH para amoladoras angulares



Especialmente adecuada para eliminación de materiales blandos (protección de bajos y pasta insonorizante). Que las cerdas estén dobladas en el extremo permite que la punta contacte con la superficie de trabajo en ángulo recto, lográndose una superficie más rugosa (como con chorro de arena). La carda se puede reafilarse hasta diez veces. Para ello se deben presionar las puntas de las cerdas 2-3 segundos en una piedra de amolar. Las puntas de las cerdas deben apuntar en sentido contrario al de la marcha.



Ref.	Código	Ancho útil mm	Espesor alambre mm	Longitud útil mm	Ø carda	r.p.m.	Rosca	€ / u.
432600	POS RBU 10020 SC Acero 0,60	20	0,60	18	100	1.200 - 3.500	M14	58,45

Cepillo circular, trenzado modelo CAM



Ref.	Código	Ancho mm	Multieje mm	Nº Hileras	Ø exterior mm	Material	€/ u.
415300	CAM 1001J22	15	16-22 - M 14	1	100		26,54
415312	CAM2001J22	15	20-22-26-30-36-40-50	1	200		39,43
415313	CAM 2002J20	25	20-22-26-30-36-40-50	2	200	Acero Templado	78,00
415315	CAM 2501J36	15	20-22-26-30-36-40-50	1	250	0,37 J	45,70
415316	CAM 2502J36	25	20-22-26-30-36-40-50	2	250		90,46
415317	CAM 2503J26	35	20-22-26-30-36-40-50	3	250		135,50
415404	CAM 1202K13	25	13-16-20-22-26-30	2	125	Acero Templado	53,31
415410	CAM 1702K26	25	13-16-20-22-26-30	2	175	0,50 K	72,08
415411	CAM 1703K20	35	13-16-20-22-26-30	3	175		107,95
415512	CAM 2001L22	15	20-22-26-30-36-40-50	1	200	Acero Templado	37,97
415513	CAM 2002L22	25	20-22-26-30-36-40-50	2	200	0,80 L	75,12
415514	CAM 2003L22	35	20-22-26-30-36-40-50	3	200		112,42
415612	CAM 2001Q22	15	20-22-26-30-36-40-50	1	200	Acero Inox. 0,50 Q	73,15
415301	CAM 1002J16	25	13-16-20-22-26-30	2	100		52,73
415303	CAM 1201J22	15	16-22 - M 14	1	125	Acero Templado	27,22
415304	CAM 1202J30	25	13-16-20-22-26-30	2	125	0,37 J	53,71
415309	CAM 1701J22	15	16-22 - M 14	1	175		37,19
415400	CAM 1001K16	15	16-22 - M 14	1	100	Acero Templado 0,50 K	26,85

Ref.	Código	Ancho mm	Multieje mm	Nº Hileras	Ø exterior mm	Material	€/ u.
415401	CAM 1002K22	25	13-16-20-22-26-30	2	100		51,45
415402	CAM 1003K20	35	13-16-20-22-26-30	3	100		77,10
415403	CAM 1201K22	15	16-22 - M 14	1	125		26,86
415406	CAM 1501K22	15	16-22 - M 14	1	150		32,17
415409	CAM 1701K22	15	16-22 - M 14	1	175	Acero Templado 0,50 K	36,35
415412	CAM 2001K22	15	20-22-26-30-36-40-50	1	200		38,59
415413	CAM 2002K22	25	20-22-26-30-36-40-50	2	200		76,53
415414	CAM 2003K50	35	20-22-26-30-36-40-50	3	200		114,38
415415	CAM 2501K20	15	20-22-26-30-36-40-50	1	250		43,84
415416	CAM 2502K50	25	20-22-26-30-36-40-50	2	250		87,36
415500	CAM 1001L22	15	16-22 - M 14	1	100		25,17
415501	CAM 1002L30	25	13-16-20-22-26-30	2	100		50,03
415502	CAM 1003L22	35	13-16-20-22-26-30	3	100		74,10
415503	CAM 1201L22	15	16-22 - M 14	1	125	Acero Templado 0,80 L	26,09
415506	CAM 1501L22	15	16-22 - M 14	1	150		31,29
415509	CAM 1701L22	15	16-22 - M 14	1	175		35,79
415515	CAM 2501L22	15	20-22-26-30-36-40-50	1	250		42,82
415516	CAM 2502L50	25	20-22-26-30-36-40-50	2	250		84,97
415517	CAM 2503L22	35	20-22-26-30-36-40-50	3	250		127,13
415600	CAM 1001Q22	15	16-22 - M 14	1	100		43,71
415603	CAM 1201Q22	15	16-22 - M 14	1	125	Acero Inox. 0,50 Q	49,71
415606	CAM 1501Q22	15	16-22 - M 14	1	150		60,73
415609	CAM 1701Q22	15	16-22 - M 14	1	175		68,48
415700	CAM 1001X22	15	16-22 - M 14	1	100	Latón 0,40 X	37,34

04

Cepillo CPL Circular Pipe-Lines Mechón de 6 mm. (1/4")



Características Técnicas: El Alambre trenzado proporciona Larga duración, gran capacidad de arranque, posibilidad de trabajo a velocidades elevadas. Aplicaciones CPL: Eliminación de cascarillas de soldadura y forja. Limpieza de soldadura en uniones de tubos de PIPE-LINES. JAZ ZUBIAURRE da respuesta a la industria de la soldadura creando un cepillo Pipeline de 76 mechones ofreciendo un mejor diseño y una capacidad de cepillado sin igual. 76 mechones significan 40% mas de capacidad de cepillado y el doble de vida útil con respecto a los cepillos estandar de 56 mechones. Puntos de soldadura en las chapas laterales que ayudan a la correcta alineación de los mechones del cepillo



Ref.	Código	Diámetro Exterior mm	Nº mechones	Ancho mm	Ejes	R.P.M Máxmas	Material	€/ u.
8001116	CPL71060KM14	100	32	6	16-22 M14-W5/8	20.000		25,36
8001118	CPL91251KM14	125	38	6	16-22 M14-W5/8	12.500	Acero Gris 0,50 mm K	27,31
8001119	CPL81565KM14	150	50	6	16-22 M14-W5/8	9.000		29,86
8001123	CPL82276KM14	225	76	6	16-22 M14-W5/8	6.000		42,19



Disco Radial Bristle (RB-ZB)



Mineral Cubitron™ I • Soporte termoplástico • Accesorios: Para los discos de 50mm y 75mm, usar el mandril 990. Para el de 150mm, usar el mandril 07948
 • Materiales: INOX, Acero, Madera • Máquinas: Amoladora recta



Ref.	Código	Medida mm	Grano	€/ u.
8003228	7100138326	25	P-36	1,94
8003229	7100138294	50	P-120	6,46

Ref.	Código	Medida mm	Grano	€/ u.
8003230	7100138295	50	P-220	6,46
8003231	7100138296	75	P-120	7,94

Carda INOX-TOTAL con mango



Se caracterizan porque todas las piezas de la carda están fabricadas de acero fino (INOX) de la calidad 1.4310 (V2A), por lo que no contaminan el material. Estas cardas son especialmente adecuadas para aplicaciones en trabajos extremadamente críticos y para condiciones de trabajo difíciles en la construcción de elementos para la industria química, en la industria de alimentación y nuclear.



Ref.	Código	Ø carda	Ancho útil mm	Longitud útil mm	Longitud mm	r.p.m.	Forma	€/ u.
431000	RBUIT 7015 Inox 0,15 M.6	70	15	19	50	6.000 - 9.800	Redonda, alambre sin trenzar	49,87
431002	PBUIT 1516 Inox 0,15 M.6	15	-	22	65	7.200 - 11.700	Forma brocha, alambre sin trenzar	40,45
431003	PBUIT 2020 Inox 0,15 M.6	20	-	25	70	7.200 - 11.700	Forma brocha, alambre sin trenzar	48,26
431050	RBUIT 3006 Inox 0,20 M.6	30	6	7	40	8.000 - 13.000	Redonda, alambre sin trenzar	36,41
431051	RBUIT 5015 Inox 0,20 M.6	50	15	13	50	6.000 - 9.800	Redonda, alambre sin trenzar	41,98
431052	PBUIT 1516 Inox 0,20 M.6	15	-	22	65	7.200 - 11.700	Forma brocha, alambre sin trenzar	40,51
431053	PBUIT 2020 Inox 0,20 M.6	20	-	25	70	7.200 - 11.700	Forma brocha, alambre sin trenzar	48,47
431054	PBGSIT 1010 Inox 0,20 M.6	10	-	25	65	4.000 - 6.500	Forma brocha, alambre trenzado	39,91
432500	RBUIT 7015 Inox 0,30 M.6	70	15	19	50	6.000 - 9.800	Redonda, alambre sin trenzar	46,57
432501	RBUIT 8015 Inox 0,30 M.6	80	15	19	50	4.800 - 7.800	Redonda, alambre sin trenzar	50,53
432550	RBGIT 7006 Inox 0,35 M.6	70	6	16	42	10.000 - 16.300	Redonda, alambre trenzado	68,55
432551	PBGSIT 1010 Inox 0,35 M.6	10	-	25	65	4.000 - 6.500	Forma brocha, alambre trenzado	39,83

Carda redonda con agujero, trenzado especial COMBITWIST



Carda muy agresiva. Adecuada para trabajos pesados en la construcción de metal como descascarillado, eliminación de óxido, limpieza de cordones de soldadura y eliminación de restos de pegamento. Máxima rentabilidad gracias a su vida útil extraordinariamente larga y al elevado arranque de material. Permite una gran comodidad de trabajo por su marcha suave sin rebotes. Adecuada para el mecanizado de esquinas y cantos, ya que se "destrenzan" menos. Para obtener resultados óptimos, utilizar en amoladoras angulares potentes.



Ref.	Código	Ancho útil mm	Espesor alambre mm	Longitud útil mm	N° trenzas	Ø	Ø Agujero mm	r.p.m. máx.	€/ u.
411600	POS RBG 11512 CT Acero 0,50 A.22	12	0,5	28	24	115	22,2	12.500	24,68
411602	POS RBG 17813 CT Acero 0,50 A.22	13	0,5	42	30	178	22,2	9.000	36,44
411603	POS RBG 17813 CT Acero 0,80 A.22	13	0,8	42	30	178	22,2	9.000	41,10
411604	POS RBG 11512 CT Inox 0,35 A.22	12	0,35	28	24	115	22,2	12.500	48,66
411605	POS RBG 12512 CT Inox 0,35 A.22	12	0,35	33	24	125	22,2	11.000	50,84
411606	POS RBG 17813 CT Inox 0,35 A.22	13	0,35	42	30	178	22,2	9.000	89,12

Carda redonda con agujero, alambre trenzado, Sistema X-LOCK



Carda agresiva. Adecuada para trabajos pesados en la construcción de metal como descascarillado, eliminación de óxido, limpieza de cordones de soldadura y eliminación de restos de pegamento. Con el sistema X-LOCK para amoladoras angulares se puede cambiar la herramienta rápida y cómodamente. En el sistema X-LOCK, en vez de ser redondo, el agujero tiene forma de x y ello permite fijar y ajustar la herramienta a la amoladora angular. Esto garantiza que diferentes herramientas se fijen de forma segura muy rápidamente.



Ref.	Código	Ø carda mm	Ancho útil mm	Longitud útil mm	Tipo de alambre	Trenzados	Fijación	€ / u.
21091046	POS RBG 11512/X-LOCK ST 0,50	115	12	22	Acero 0,5	24	Sistema X-LOCK	28,47
21091047	POS RBG 12512/X-LOCK ST 0,50	125	12	28	Acero 0,5	24	Sistema X-LOCK	32,33
21091048	POS RBG 11512/X-LOCK INOX 0,50	115	12	22	Inox 0,5	24	Sistema X-LOCK	57,98
21091049	POS RBG 12512/X-LOCK INOX 0,50	125	12	28	Inox 0,5	24	Sistema X-LOCK	59,93
21091050	POS RBG 11506/X-LOCK PIPE ST 0,50	115	6	21	Acero 0,5	36	Sistema X-LOCK	40,04
21091051	POS RBG 12506/X-LOCK PIPE ST 0,50	125	6	18	Acero 0,5	48	Sistema X-LOCK	42,22

Taza ondulada modelo TO



Ref.	Código	Casquillos Roscados mm	Ejes Lisos mm	Ø exterior mm	Saliente de púa mm	Material	€ / u.
415901	TO 0800EM14	M14-M10-W5/8"	16-22	80	30	Acero Latonado 0,20 E	19,94
415902	TO 1000EM14	M14-M10-W5/8"	16-22	100	30		24,54
415903	TO 1250EM14	M14-M10-W5/8"	16-22	125	30		36,32
415904	TO 1500EM14	M14-M10-W5/8"	16-22	150	40		41,27
416001	TO 0800GM14	M14-M10-W5/8"	16-22	80	30	Acero Latonado 0,30 G	21,60
416002	TO 1000GM14	M14-M10-W5/8"	16-22	100	30		26,60
416003	TO 1250GM14	M14-M10-W5/8"	16-22	125	30		39,05
416004	TO 1500GM14	M14-M10-W5/8"	16-22	150	40		42,28
416100	TO 0600HM14	M14-M10-W5/8"	16	60	20	Acero Latonado 0,40 H	14,92
416101	TO 0800HM14	M14-M10-W5/8"	16-22	80	30		19,71
416102	TO 1000HM14	M14-M10-W5/8"	16-22	100	30		25,75
416103	TO 1250HM14	M14-M10-W5/8"	16-22	125	30		35,55
416200	TO 0600NM14	M14-M10-W5/8"	16	60	20	Acero Inox. 0,20 N	30,18
416201	TO 0800NM14	M14-M10-W5/8"	16-22	80	30		47,65
416202	TO 1000NM14	M14-M10-W5/8"	16-22	100	30		59,63
416300	TO 0600VM14	M14-M10-W5/8"	16	60	20		21,76
416301	TO 0800VM14	M14-M10-W5/8"	16-22	80	30	Acero Inox. 0,30 Z	32,46
416302	TO 1000VM14	M14-M10-W5/8"	16-22	100	30		35,37
416303	TO 1250VM14	M14-M10-W5/8"	16-22	125	30		44,51
416304	TO 1500VM14	M14-M10-W5/8"	16-22	150	40		103,24
416400	TO 0600ZM14	M14-M10-W5/8"	16	60	20	Latón 0,30 V	25,59
416401	TO 0800ZM14	M14-M10-W5/8"	16-22	80	30		40,18
416402	TO 1000ZM14	M14-M10-W5/8"	16-22	100	30		50,37
416403	TO 1250ZM14	M14-M10-W5/8"	16-22	125	30		72,00
416404	TO 1500ZM14	M14-M10-W5/8"	16-22	150	40	103,24	

04

Carda cónica con rosca, trenzado especial COMBITWIST



Carda muy agresiva. Adecuada para trabajos pesados, como desbarbado, limpieza y eliminación de óxido. Llegan de manera óptima a los puntos de difícil acceso, como cantos interiores, rendijas y ranuras. Máxima rentabilidad gracias a su vida útil extraordinariamente larga y al elevado arranque de material. Permite una gran comodidad de trabajo por su marcha suave sin rebotes. Adecuada para el mecanizado de esquinas y cantos, ya que se "destreñan" menos. Para obtener resultados óptimos, utilizar en amoladoras angulares potentes.



Ref.	Código	Ancho útil mm	Espesor alambre mm	Longitud útil mm	Nº trenzas	Ø	r.p.m. máx.	Rosca	€/ u.
411700	POS KBG 10013 CT Acero 0,50 M14	13	0,5	22	22	100	20.000	M 14	22,03
411701	POS KBG 11515 CT Acero 0,50 M14	15	0,5	26	22	115	15.000	M 14	30,45
411702	POS KBG 12515 CT Acero 0,50 M14	15	0,5	19	28	125	15.000	M 14	38,73
411704	POS KBG 11515 CT Inox 0,35 M14	15	0,35	26	22	115	15.000	M 14	46,21
411705	POS KBG 12515 CT Inox 0,35 M14	15	0,35	19	28	125	15.000	M 14	60,86

Taza modelo TITAN



Ref.	Código	Casquillos Roscados mm	Diámetro exterior mm	Ejes Lisos mm	Nº Hileras	Saliente de púa mm	Material	€/ u.
416500	TT 0801JM14	M14-M10-W5/8"	80	16-22	1	25	Acero Templado 0,37 J	31,87
416501	TT 1001JM14	M14-M10-W5/8"	100	16-22	1	30		33,64
416502	TT 1251JM14	M14-M10-W5/8"	125	16-22	1	30		46,37
416503	TT 1501JM14	M14-M10-W5/8"	150	16-22	1	35	Acero Templado 0,50 J	64,91
416600	TT 0801KM14	M14-M10-W5/8"	80	16-22	1	25		28,60
416601	TT 1001KM14	M14-M10-W5/8"	100	16-22	1	30		30,47
416602	TT 1251KM14	M14-M10-W5/8"	125	16-22	1	30	Acero Templado 0,80 L	38,62
416603	TT 1501KM14	M14-M10-W5/8"	150	16-22	1	35		58,44
416700	TT 0801LM14	M14-M10-W5/8"	80	16-22	1	25		30,08
416701	TT 1001LM14	M14-M10-W5/8"	100	16-22	1	30	Acero Templado 0,80 L	31,38
416702	TT 1251LM14	M14-M10-W5/8"	125	16-22	1	30		40,38
416703	TT 1501LM14	M14-M10-W5/8"	150	16-22	1	35		61,86
416800	TT 0801QM14	M14-M10-W5/8"	80	16-22	1	25	Acero Inox. 0,50 Q	58,44
416801	TT 1001QM14	M14-M10-W5/8"	100	16-22	1	30		66,72
416802	TT 1251QM14	M14-M10-W5/8"	125	16-22	1	30		89,30
416803	TT 1501QM14	M14-M10-W5/8"	150	16-22	1	35	Latón 0,40 X	135,48
416900	TT 0801XM14	M14-M10-W5/8"	80	16-22	1	25		47,87
416901	TT 1001XM14	M14-M10-W5/8"	100	16-22	1	30		52,94
416902	TT 1251XM14	M14-M10-W5/8"	125	16-22	1	30	71,54	

Carda forma vaso, alambre sin trenzar, Sistema X-LOCK



Excelentes para trabajos semi-pesados, como desbarbado, limpieza y eliminación de óxido sobre grandes superficies. Con el sistema X-LOCK para amoladoras angulares se puede cambiar la herramienta rápida y cómodamente. En el sistema X-LOCK, en vez de ser redondo, el agujero tiene forma de x y ello permite fijar y ajustar la herramienta a la amoladora angular. Esto garantiza que diferentes herramientas se fijen de forma segura muy rápidamente.



Ref.	Código	Ø carda mm	Longitud útil mm	Tipo de alambre	Fijación	€/ u.
21091052	POS TBU 60/X-LOCK ST 0,30	60	20	Acero 0,3	Sistema X-LOCK	15,38
21091054	POS TBU 60/X-LOCK INOX 0,30	60	20	Inox 0,3	Sistema X-LOCK	22,12

Carda forma vaso, alambre trenzado, Sistema X-LOCK



Carda agresiva. Excelente para trabajos pesados, como desbarbado, limpieza y eliminación de óxido sobre grandes superficies. Con el sistema X-LOCK para amoladoras angulares se puede cambiar la herramienta rápida y cómodamente. En el sistema X-LOCK, en vez de ser redondo, el agujero tiene forma de x y ello permite fijar y ajustar la herramienta a la amoladora angular. Esto garantiza que diferentes herramientas se fijen de forma segura muy rápidamente.



Ref.	Código	Ø carda mm	Longitud útil mm	Tipo de alambre	Trenzados	Fijación	€ / u.
21091057	POS TBG 65/X-LOCK ST 0,50	65	22	Acero 0,5	18	Sistema X-LOCK	17,55
21091060	POS TBG 65/X-LOCK INOX 0,50	65	22	Inox 0,5	18	Sistema X-LOCK	36,74

Cepillo brocha modelo B industrial



Ref.	Código	Modelo	Ø Cazoleta	Saliente de púa mm	Material	€ / u.
419000	BA 1200E	A	12	20	Acero Latonado 0,30 E	5,30
419001	BB 1201E	B	12	20		5,85
419002	BC 1900E	C	19	30		6,10
419003	BC 2600E	C	26	30		6,84
419004	BD 1901E	D	19	30		8,11
419005	BD 2601E	D	26	30		7,68
419006	BE 2602E	E	26	30		8,45
419007	BF 3000E	F	30	40	10,78	
419204	BD 1901H	D	19	30	Acero Latonado 0,50 H	6,66
419310	BR 2500K	R	25	25	Acero Gris 0,50 K	16,17
419311	BR 3000K	R	30	25		17,98
419400	BA 1200N	A	12	20	Acero Inox. 0,20 N	10,19
419401	BB 1201N	B	12	20		10,98
419402	BC 1900N	C	19	30		11,33
419403	BC 2600N	C	26	30		16,74
419404	BD 1901N	D	19	30		15,08
419405	BD 2601N	D	26	30		8,30
419406	BE 2602N	E	26	30		18,54
419407	BF 3000N	F	30	40	24,68	
419500	BA 1200V	A	12	20	Acero Inox. 0,30 Z	7,27
419501	BB 1201Z	B	12	20		9,04
419502	BC 1900Z	C	19	30		9,56
419503	BC 2600Z	C	26	30		14,08
419504	BD 1901Z	D	19	30		13,01
419505	BD 2601Z	D	26	30		15,05
419506	BE 2602Z	E	26	30		15,82
419507	BF 3000Z	F	30	40	20,64	
419610	BR 2500Z	R	25	25	Latón 0,50 Q	26,07
419611	BR 3000Z	R	30	25		28,95
419700	BA 1200Z	A	12	20	A. Temp. 0,30 V	8,56
419701	BB 1201V	B	12	20		8,20
419702	BC 1900V	C	19	30		8,64
419703	BC 2600V	C	26	30		9,63
419704	BD 1901V	D	19	30		9,30
419705	BD 2601V	D	26	30		10,78
419706	BE 2602V	E	26	30		11,77
419707	BF 3000V	F	30	40	15,94	

04



Carda forma brocha con mango, trenzado especial SINGLETWIST



Carda trenzada de trenzado simple especialmente flexible para trabajos especiales. Permite llegar de forma óptima a puntos de difícil acceso, como ángulos interiores, ya que el trenzado no se abre. Para obtener resultados óptimos, utilizar en máquinas con regulación del número de revoluciones. Para obtener un rendimiento óptimo, utilizar una máquina con 300 vatios como mínimo.



Ref.	Código	Espesor alambre mm	Longitud mm	Longitud útil mm	N° trenzas	Ø	Ø Mango mm	r.p.m. máx.	€/ u.
411800	PBGS 1010 Acero 0,20 M.6	0,2	65	25	1	10	6	4.500	7,84
411801	PBGS 1010 Acero 0,35 M.6	0,35	65	25	1	10	6	4.500	7,94
411802	PBGS 1010 Acero 0,50 M.6	0,5	65	25	1	10	6	4.500	7,75
411803	PBGS 1010 Inox 0,20 M.6	0,2	65	25	1	10	6	4.500	8,82
411804	PBGS 1010 Inox 0,35 M.6	0,35	65	25	1	10	6	4.500	8,63
411805	PBGS 1010 Inox 0,50 M.6	0,5	65	25	1	10	6	4.500	8,52

Linea HS de altas revoluciones - 11.000 r.p.m.



HSC



HSD



HST



HSK



HSR

Ref.	Código	Casquillos Roscados mm	Diámetro exterior mm	Saliente de púa mm	Material	€/ u.
417000	HSC0075EM14	M14-M10-W5/8"	75	22	Acero Latonado 0,30 E	19,38
417001	HSD0085EM14	M14-M10-W5/8"	85	12		17,99
417002	HSD0100EM14	M14-M10-W5/8"	100	24		19,93
417003	HSP0115EM14	M14-M10-W5/8"	115	25	Acero Templado 0,50 K	18,47
417104	HST0065KM14	M14-M10-W5/8"	65	20		18,31
417105	HSK0100QM14	M14-M10-W5/8"	100	22	Acero Inox. 0,30 Z	44,37
417106	HSR0115KM14	M14-M10-W5/8"	115	26		23,31
417200	HSC0075ZM14	M14-M10-W5/8"	75	22	Acero Inox. 0,30 Z	40,96
417201	HSD0085ZM14	M14-M10-W5/8"	85	12		38,07
417202	HSD0100ZM14	M14-M10-W5/8"	100	24		42,18
417203	HSP0115ZM14	M14-M10-W5/8"	115	25	Acero Inox. 0,50 Q	39,46
417304	HST0065QM14	M14-M10-W5/8"	65	20		38,83
417305	HSK0100KM14	M14-M10-W5/8"	100	22	Acero Inox. 0,50 Q	20,93
417306	HSR0115QM14	M14-M10-W5/8"	115	26		45,06

Taza ondulada



Para la limpieza de Musgo y césped en pavimentos, bordillos, zonas adoquinadas y esquinas de difícil acceso.



Ref.	Código	Diámetro exterior mm	Saliente	Eje liso	Multieje mm	Material	€/ u.
21059000	HSK0175K22	175	50mm	22	15-25,4	Acero Gris 0,50 K	65,57

Cepillo de control



Control y ergonomía durante el cepillado: Los nuevos cepillos de control de JAZ incorporan una funda rígida de materia l degradable que sujeta los alambres de acero impidiendo su apertura y consiguiendo de ese modo, el control de la superficie de cepillado y un alto grado de ergonomía durante el trabajo.

Seguridad total: Estos nuevos cepillos de JAZ evitan las roturas de fragmentos de alambre y aportan una extraordinaria mejora de la seguridad durante el cepillado. Estos cepillos facilitan asimismo su manipulación, protegiendo al usuario de posibles pinchazos producidos por el alambre.

Mayor rendimiento: Los nuevos cepillos de control de JAZ proporcionan una excelente mejora del rendimiento en comparación con los cepillos tradicionales al eliminar las roturas de los alambres y prolongar su vida útil.



Ref.	Código	Ø exterior mm	Rosca	Tipo alambre	€ / u.
432700	CCO0800HM14	80	M14-M10-W5/8	Ondulado	19,94
432701	CCO1250HM14	125	M14-M10-W5/8	Ondulado	36,32
432750	CCT0801LM14	80	M14-M10-W5/8	Trenzado	28,60
432751	CCT1251LM14	125	M14-M10-W5/8	Trenzado	38,62

Cepillo BS para piezas de revolución



Especialmente diseñado para piezas de revolución.

Facilita la limpieza de la pieza sin desmontarla.

Aplicaciones BS: Eliminación de rebabas, óxido, pintura, etc. Ideal para trabajos de mantenimiento.

Disponibile en diferentes diámetros y calidades de alambre.

Ref.	Código	Ø espiga	Ø exterior mm	Ø pieza(s)	Material	€ / u.	
432720	BS6010E	6	60	10	Acero Latonado 0,30 mm E	37,72	
432721	BS6012E	6	60	12		37,72	
432722	BS6014E	6	60	14		37,72	
432723	BS6016E	6	60	16		37,72	
432724	BS6018E	6	60	18		37,72	
432725	BS6020E	6	60	20		37,72	
432726	BS6022E	6	60	22		37,72	
432727	BS6024E	6	60	24		37,72	
432728	BS6026E	6	60	26		37,72	
432729	BS6028E	6	60	28		37,72	
432730	BS6030E	6	60	30		37,72	
432731	BS6010Z	6	60	10		Acero Inox. 0,30 mm Z	41,69
432733	BS6014Z	6	60	14			41,69
432734	BS6016Z	6	60	16			41,69
432735	BS6018Z	6	60	18	41,69		
432736	BS6020Z	6	60	20	41,69		
432737	BS6022Z	6	60	22	41,69		
432738	BS6024Z	6	60	24	41,69		
432739	BS6026Z	6	60	26	41,69		
432740	BS6028Z	6	60	28	41,69		
432741	BS6030Z	6	60	30	41,69		



Disco y taza modelo BTE / BDER para taladro



Ref.	Código	Diámetro exterior mm	Ø mm	Material	€ / u.
418600	BDER 5030	50	0,30	Acero Latonado	2,56
418602	BDER 6030	60	0,30	Acero Latonado	2,56
418604	BDER 7530	75	0,30	Acero Latonado	3,39
418606	BDER 1030	100	0,30	Acero Latonado	4,82
418608	BTE 5030	50	0,30	Acero Latonado	3,34
418610	BTE 7530	75	0,30	Acero Latonado	4,83
418612	BTE 8030	85	0,30	Acero Latonado	7,81
418700	BDER 9348	50	0,30	Acero Latonado	3,13
418702	BDER 9448	60	0,30	Acero Latonado	3,13
418704	BDER 9548	75	0,30	Acero Latonado	3,94
418706	BDER 9648	100	0,30	Acero Latonado	5,50
418708	BTE 9168	50	0,30	Acero Latonado	3,91
418710	BTE 9268	75	0,30	Acero Latonado	5,37
418712	BTE 9368	85	0,30	Acero Latonado	8,35



BDER



BTE

Cepillo encapsulado



Características Técnicas:

- *El recubrimiento de caucho protege la oxidación del alambre.
- * Control total sobre la superficie a cepillar.
- * El cepillado en ranuras, en componentes de geometrías complejas es ahora más sencillo.
- * El caucho que recubre el alambre se degrada de forma regular obteniendo así un alto rendimiento de la herramienta.
- * Desaparecen las proyecciones de acero.
- * Mayor rendimiento que un cepillo de monofilamento estándar
- * Mejora la manipulación, evitando pinchazos al usuario. Aplicaciones:
- * Ideal para eliminar cascarilla en los cordones de soldadura.
- * Para el sector OIL&GAS
- * Cepillado de aristas.
- * Adecuado para trabajos en ambientes marinos



Ref.	Código	Diámetro Exterior mm	Saliente mm	Espiga mm	Material	€ / u.
8001128	ENC1900E	19	23	6	Acero Latonado 0,30 mm E	20,07
8001129	ENC2600E	26	23	6	Acero Latonado 0,30 mm E	22,50
8001130	ENC3000E	30	23	6	Acero Latonado 0,30 mm E	24,94

Disco trenzado modelo CAE con espiga de 6 mm



Ref.	Código	Diámetro exterior mm	Tipo alambre	Material	€ / u.
420250	CAE 7500K	75	Trenzado	Acero Gris 0,50 K	15,21



Disco minor industrial modelo CDE



Ref.	Código	Ancho mm	Diámetro exterior mm	Material	€ / u.
419800	CDE 3000C	10	30	Acero Latonado 0,20 C	5,61
419801	CDE 4000C	10	40	Acero Latonado 0,20 C	5,95
419802	CDE 5000C	10	50	Acero Latonado 0,20 C	6,45
419903	CDE 6000E	15	60	Acero Latonado 0,30 E	6,91
419904	CDE 7500E	15	75	Acero Latonado 0,30 E	7,64
419905	CDE 1000E	15	100	Acero Latonado 0,30 E	12,27
420000	CDE 3000N	10	30	Acero Inox. 0,20 N	12,25
420001	CDE 4000N	10	40	Acero Inox. 0,20 N	13,36
420002	CDE 5000N	10	50	Acero Inox. 0,20 N	14,30
420103	CDE 6000Z	15	60	Acero Inox. 0,30 Z	16,38
420104	CDE 7500V	15	75	Acero Inox. 0,30 Z	12,68
420105	CDE 1000Z	15	100	Acero Inox. 0,30 Z	21,25
420203	CDE 6000V	15	60	Latón 0,30 V	11,68
420204	CDE 7500Z	15	75	Latón 0,30 V	18,23
420205	CDE 1000V	15	100	Latón 0,30 V	20,84



04

Cepillo encapsulado gama tipo CDE



Características Técnicas:

- *El recubrimiento de caucho protege la oxidación del alambre.
- *Control total sobre la superficie a cepillar.
- * El cepillado en ranuras, en componentes de geometrías complejas es ahora más sencillo.
- * El caucho que recubre el alambre se degrada de forma regular obteniendo así un alto rendimiento de la herramienta.
- * Desaparecen las proyecciones de acero.
- * Mayor rendimiento que un cepillo de monofilamento estándar
- * Mejora la manipulación, evitando pinchazos al usuario. Aplicaciones:
- * Ideal para eliminar cascarilla en los cordones de soldadura.
- * Para el sector OIL&GAS
- * Cepillado de aristas.
- * Adecuado para trabajos en ambientes marinos



Ref.	Código	Diámetro Exterior mm	Ancho (mm)	Espiga mm	Material	€ / u.
8001126	ENC6000E	60	6	6	Acero Latonado 0,30 mm E	22,50
8001127	ENC7500E	75	6	6	Acero Latonado 0,30 mm E	23,72

Cepillo Radial Bristle con Eje Margarita (BB-ZS)



Mineral Cubitron™ I

- Soporte termoplástico
- Accesorios: Para los discos de 50mm y 75mm, usar el mandril 990. Para el de 150mm, usar el mandril 07948
- Materiales: INOX, Acero, Madera
- Máquinas: Amoladora recta



Ref.	Código	Medida mm	Grano	€ / u.
8003232	7000078180	50	P-80	31,85
8003233	7000078175	50	P-120	31,85
8003234	7000078179	50	P-220	31,85
8003235	7000078176	75	P-80	32,85
8003236	7000078177	75	P-120	32,85
8003237	7000078178	75	P-220	32,85

Cepillo limpiatubos modelo L1 / L2



Ref.	Código	Diámetro exterior mm	Rosca de amarre r	Material	€ / u.
420418	L2 2502G	25	W 1/2" - M6 Hembra	Acero Latonado 0,40 G	46,17
420419	L2 3002G	30	W 1/2" - M6 Hembra		46,17
420420	L2 4002G	40	W 1/2" - M6 Hembra		46,17
420421	L2 5002G	50	W 1/2" - M6 Hembra		46,17
420422	L2 7002G	70	W 1/2" - M6 Hembra		48,72
420423	L2 0102G	100	W 1/2" - M6 Hembra	49,99	
420500	L1 1001N	10	W 1/4" - M6 Hembra	Acero Inox. 0,20 N	41,13
420501	L1 1201N	12	W 1/4" - M6 Hembra		41,13
420502	L1 1401N	14	W 1/4" - M6 Hembra		41,13
420503	L1 1501N	15	W 1/4" - M6 Hembra		41,13
420504	L1 1601N	16	W 1/4" - M6 Hembra		41,13
420505	L1 2001N	20	W 1/4" - M6 Hembra	41,13	
420606	L1 2501P	25	W 1/2" - M6 Hembra	Acero Inox. 0,40 P	31,01
420607	L1 3001P	30	W 1/2" - M6 Hembra		31,01
420608	L1 3501P	35	W 1/2" - M6 Hembra		31,01
420609	L1 4001P	40	W 1/2" - M6 Hembra		31,01
420610	L1 4501P	45	W 1/2" - M6 Hembra		31,01
420611	L1 5001P	50	W 1/2" - M6 Hembra	31,01	
420612	L1 6001P	60	W 1/2" - M6 Hembra	31,01	
420613	L1 7001P	70	W 1/2" - M6 Hembra	31,01	
420700	L1 1001V	10	W 1/4" - M6 Hembra	Latón 0,30 V	35,63
420701	L1 1201V	12	W 1/4" - M6 Hembra		35,63
420702	L1 1401V	14	W 1/4" - M6 Hembra		35,63
420703	L1 1501V	15	W 1/4" - M6 Hembra		35,63
420704	L1 1601V	16	W 1/4" - M6 Hembra		35,63
420705	L1 2001V	20	W 1/4" - M6 Hembra	35,63	
420806	L1 2501X	25	W 1/2" - M6 Hembra	Latón 0,40 X	26,75
420807	L1 3001X	30	W 1/2" - M6 Hembra		26,75
420808	L1 3501X	35	W 1/2" - M6 Hembra		26,75
420809	L1 4001X	40	W 1/2" - M6 Hembra		26,75
420810	L1 4501X	45	W 1/2" - M6 Hembra		26,75
420811	L1 5001X	50	W 1/2" - M6 Hembra	26,75	
420812	L1 6001X	60	W 1/2" - M6 Hembra	26,75	
420813	L1 7001X	70	W 1/2" - M6 Hembra	26,75	



LIF Cepillo limpiatubos flexibles



Características Técnicas LIF. Se utilizan tanto manualmente como acoplados a máquinas portátiles y fijas. El elemento de fijación lo constituye el tornillo situado en un extremo del cepillo. Varilla Flexible y Alambre ondulado. Aplicaciones LIF. Limpieza de óxidos, pinturas, cascarillas, rebabas y adherencias en general. Interiores de tubos, moldes, orificios, etc



Ref.	Código	Diámetro mm	Rosca mm	Material	€/ u.
8001175	LIF1001N	10	W 1/4"		27,31
8001176	LIF1001NM6H	10	M6 Hembra		27,31
8001177	LIF1501N	15	W 1/4"	Acero Inoxidable 0,20 mm N	27,31
8001178	LIF1501NM6H	15	M6 Hembra		27,31
8001179	LIF2001N	20	W 1/4"		27,31
8001181	LIF2501P	25	W 1/2"		18,06
8001183	LIF3001P	30	W 1/2"		18,06
8001185	LIF3501P	35	W 1/2"		18,06
8001187	LIF4001P	40	W 1/2"	Acero Inoxidable 0,40 mm P	18,06
8001189	LIF4501P	45	W 1/2"		20,67
8001191	LIF5001P	50	W 1/2"		20,67
8001197	LIF7001P	70	W 1/2"		20,67
8001131	LIF0101G	100	W 1/2"		13,59
8001132	LIF0101GM6H	100	M6 Hembra	Acero Latonado 0,40 mm G	13,59
8001133	LIF1001D	10	W 1/4"		15,58
8001134	LIF1001DM6H	10	M6 Hembra		15,58
8001135	LIF1201D	12	W 1/4"		15,58
8001136	LIF1201DM6H	12	M6 Hembra		15,58
8001137	LIF1301D	13	W 1/4"		15,58
8001138	LIF1301DM6H	13	M6 Hembra		15,58
8001139	LIF1401D	14	W 1/4"		15,58
8001140	LIF1401DM6H	14	M6 Hembra	Acero Latonado 0,25 mm D	15,58
8001141	LIF1501D	15	W 1/4"		15,58
8001142	LIF1501DM6H	15	M6 Hembra		15,58
8001143	LIF1601D	16	W 1/4"		15,58
8001144	LIF1601DM6H	16	M6 Hembra		15,58
8001145	LIF1801D	18	W 1/4"		15,58
8001146	LIF1801DM6H	18	M6 Hembra		15,58
8001147	LIF2001D	20	W 1/4"		15,58
8001148	LIF2001DM6H	20	M6 Hembra		15,58

Ref.	Código	Diámetro mm	Rosca mm	Material	€/ u.
8001149	LIF2501G	25	W 1/2"		10,95
8001150	LIF2501GM6H	25	M6 Hembra		10,95
8001151	LIF3001G	30	W 1/2"		10,95
8001152	LIF3001GM6H	30	M6 Hembra		10,95
8001153	LIF3501G	35	W 1/2"		10,95
8001154	LIF3501GM6H	35	M6 Hembra		10,95
8001155	LIF4001G	40	W 1/2"		10,95
8001156	LIF4001GM6H	40	M6 Hembra		10,95
8001157	LIF4501G	45	W 1/2"		11,51
8001158	LIF4501GM6H	45	M6 Hembra		11,51
8001159	LIF5001G	50	W 1/2"		11,51
8001160	LIF5001GM6H	50	M6 Hembra		11,51
8001161	LIF5501G	55	W 1/2"	Acero Latonado 0,40 mm G	11,51
8001162	LIF5501GM6H	55	M6 Hembra		11,51
8001163	LIF6001G	60	W 1/2"		11,51
8001164	LIF6001GM6H	60	M6 Hembra		11,51
8001165	LIF6501G	65	W 1/2"		11,51
8001166	LIF6501GM6H	65	M6 Hembra		11,51
8001167	LIF7001G	70	W 1/2"		11,51
8001168	LIF7001GM6H	70	M6 Hembra		11,51
8001169	LIF7501G	75	W 1/2"		13,59
8001170	LIF7501GM6H	75	M6 Hembra		13,59
8001171	LIF8001G	80	W 1/2"		13,59
8001172	LIF8001GM6H	80	M6 Hembra		13,59
8001173	LIF9001G	90	W 1/2"		13,59
8001174	LIF9001GM6H	90	M6 Hembra		13,59

Cepillo manual universal modelo VIP



Ref.	Código	Longitud Saliente púa (S) mm	Longitud Total (L) mm	Longitud Útil (U) mm	Material	€/ u.
420900	VIP 1000F	28	225	123	Acero Latonado 0,35 F	2,69
421000	VIP 1000V	28	225	123	Acero Inox. 0,30 V	8,39
421100	VIP 1000Z	28	225	123	Latón 0,40 Z	8,91





Cepillo manual soldador modelo MS

Ref.	Código	Longitud Madera mm	Nº Hileras	Material	€/ u.
421200	MS 3000G	290	3	Acero Púa Plana 0,90 x 0,50 T	1,88
421201	MS 4000G	290	4		2,34
421202	MS 5000G	290	5		2,95
421300	MS 3000P	290	3	Acero Latonado 0,40 G	8,10
421301	MS 4000P	290	4		9,63
421302	MS 5000P	290	5		11,42
421400	MS 3000T	290	3	Acero Inox. 0,40 P	3,45
421401	MS 4000T	290	4		4,46
421402	MS 5000T	290	5		5,63
421500	MS 3000X	290	3	Latón 0,40 X	4,70
421501	MS 4000X	290	4		6,21
421502	MS 5000X	290	5		8,34



Cepillo manual con mango extralargo

Adecuado para la limpieza, la eliminación de óxido y la limpieza de cordones de soldadura y de superficies. Mango especialmente largo.

Ref.	Código	Espesor alambre mm	Longitud mm	Longitud útil mm	Nº Hileras	€/ u.
411860	HBU 40 Acero 0,35 LH	0,35	350	25	3	7,08
411861	HBU 30 Acero 0,35 LH	0,35	350	25	4	5,37



Cepillo manual para cordones angulares

Su forma en V los hace ideales para la limpieza y la eliminación de óxido de cordones angulares y en forma de V.

Ref.	Código	Espesor alambre mm	Longitud mm	Longitud útil mm	Nº Hileras	€/ u.
411870	HBK 30 Acero 0,35	0,35	290	35	3	6,90
411871	HBK 30 Inox 0,35	0,35	290	35	3	14,44



Cepillo manual fundición modelo MF

Ref.	Código	Longitud Madera mm	Saliente de púa mm	Material	€/ u.	Ref.	Código	Longitud Madera mm	Saliente de púa mm	Material	€/ u.
421600	MF 5030T	180	30	Acero Púa Plana 0,90 x 0,50 T	4,46	421702	MF 6050G	200	50	Acero Latonado 0,40 G	5,29
421601	MF 6035T	200	35	Acero Púa Plana 0,90 x 0,50 T	6,30	421800	MF 5030P	180	30	Acero Inox. 0,40 P	11,50
421602	MF 6050T	200	50	Acero Púa Plana 0,90 x 0,50 T	7,70	421801	MF 6035P	200	35	Acero Inox. 0,40 P	12,00
421700	MF 5030G	180	30	Acero Latonado 0,40 G	3,06	421900	MF 5030X	180	30	Latón 0,40 X	8,79
421701	MF 6035G	200	35	Acero Latonado 0,40 G	4,32	421901	MF 6035X	200	35	Latón 0,40 X	9,19



Cepillo manual bruza carretera madera plana MBCP

Ref.	Código	Ancho Madera mm	Longitud Madera mm	Nº Hileras	Saliente de púa mm	Material	€/ u.
422000	MBCP 7000G	65	360	7	50	Acero Latonado 0,40 G	20,64



Garra con mango modelo MGAR



Ref.	Código	Ø Mango mm	€ / u.
413960	MGAR 2820	28	2,14



Cepillo manual limpiabujías modelo MLB



Ref.	Código	Material	€ / u.
422100	MLB 4515	Acero	2,28
422202	MLB 4520	Latón	2,22
422301	MLB 4530	Nylon	2,05



Cepillo manual joyero modelo MJ



Ref.	Código	Ancho mm	Longitud mm	Nº Hileras	Saliente de púa mm	€ / u.
422400	MJ 4015	20	230	4	20	6,34
422401	MJ 5015	24	230	5	20	7,43



Cepillo nylon abrasivo



DNA



LNA

BNA

Ref.	Código	Modelo	Diámetro exterior mm	Ancho mm	Saliente mm	Eje rosca	Grano	€ / u.
422500	DNA 151199	DNA	150	13	27	13-16-20-22-26-30-50	120 Alto	48,56
422601	DNA 151299		150	13	27		180 Medio	48,56
422703	DNA 151399		150	13	27		320 Fino	48,56
422504	DNA 152199		150	28	27		120 Alto	89,06
422605	DNA 152299		150	28	27		180 Medio	89,06
422706	DNA 152399		150	28	27		320 Fino	89,06
422507	DNA 171199		175	16	40		120 Alto	57,69
422608	DNA 171299		175	16	40		180 Medio	57,69
422709	DNA 171399		175	16	40		320 Fino	57,69
422511	DNA 172199		175	29	40		120 Alto	103,23
422612	DNA 172299		175	29	40		180 Medio	103,23
422713	DNA 172399		175	29	40		320 Fino	103,23
422514	DNA 201199		200	16	40		120 Alto	72,89
422615	DNA 201299		200	16	40		180 Medio	72,89
422716	DNA 201399		200	16	40		320 Fino	72,89
422517	DNA 202199		200	29	40		120 Alto	121,47
422618	DNA 202299		200	29	40		180 Medio	121,47
422719	DNA 202399		200	29	40		320 Fino	121,47
422520	TNA 110199		TNA	110	-		35	22-M14
422621	TNA 110299	110		-	35	180 Medio	59,71	
422722	TNA 110399	110		-	35	320 Fino	59,71	
422623	BNA 2502	BNA	26	-	30	6 mm	180 Medio	10,98
422624	LNA 2012		20	-	-		180 Medio	10,98
422625	LNA 2512	LNA	25	-	-	W1/4" W1/2"	180 Medio	19,89
422626	LNA 4012		40	-	-		180 Medio	21,57
422627	LNA 5012		50	-	-		180 Medio	22,48



524
Soldadura
oxiacetilénica



532
Inverter
electrodo



541
Plasma



526
Soldadura
aerobutánica



534
Inverter TIG



542
Aspiradores
de humos



528
Manorreductores



537
Transformadores



542
Pinzas



529
Sopletes



538
Máquinas
de hilo



543
Antorchas



532
Soldadores



540
Soldadura por
puntos



546
Electrodos

SOLDADURA

05



Mango



Para Oxígeno-Acetileno

Ref.	Código	Descripción	€ / u.
300100	70200100	Mango universal, rosca izquierda	111,82



Lanza para soldar



Para Oxígeno-Acetileno

Ref.	Código	Descripción	€ / u.
300200	70400000	Núm. 0, consumo 75 l/h	39,66
300201	70400100	Núm. 1, consumo 150 l/h	42,84
300202	70400200	Núm. 2, consumo 300 l/h	44,61
300203	70400300	Núm. 3, consumo 500 l/h	46,73
300204	70400400	Núm. 4, consumo 750 l/h	49,32



Boquilla para lanzas de soldar



Para Oxígeno-Acetileno

Ref.	Código	Descripción	€ / u.
300300	70419001	Núm. 0, consumo 75 l/h	8,95
300301	70419101	Núm. 1, consumo 150 l/h	9,53
300302	70419201	Núm. 2, consumo 300 l/h	11,42
300303	70419301	Núm. 3, consumo 500 l/h	12,01
300304	70419401	Núm. 4, consumo 750 l/h	16,12



Boquilla exterior de corte



Para Oxígeno-Acetileno. Contiene 5 boquillas.



Ref.	Código	Descripción	€ / u.
300500	70119101P	Núm. 1, espesor de corte 2 - 10 mm	45,31
300501	70119102P	Núm. 2, espesor de corte 10 - 25 mm	45,31

Ref.	Código	Descripción	€ / u.
300502	70119103P	Núm. 3, espesor de corte 25-30/30-50/50-100 mm	45,31
300503	70119104P	Núm. 4, espesor de corte 100-150/150-200/200-300 mm	45,31

Dispositivo de corte



Para Oxígeno-Acetileno

Ref.	Código	Descripción	€ / u.
300400	70100000	Dispositivo de corte sin boquillas	100,52



Soplete soldador Minor



Ref.	Código	Descripción	€/ u.
300025	10500000	Soplete soldador MINOR para OX-AC con 6 boquillas y cruceta	64,74
300026	10502015	Lanza para incorporar al soplete soldador MINOR	27,78

Boquilla para soplete Minor



Para Oxígeno-Acetileno. Contiene 5 boquillas.



Ref.	Código	Descripción	€/ u.	Ref.	Código	Descripción	€/ u.
300900	10501117P	Núm. 1, consumo 50 l/h	31,54	300903	10501417P	Núm. 4, consumo 140 l/h	31,54
300901	10501217P	Núm. 2, consumo 70 l/h	31,54	300904	10501517P	Núm. 5, consumo 200 l/h	31,54
300902	10501317P	Núm. 3, consumo 100 l/h	31,54	300905	10501617P	Núm. 6, consumo 400 l/h	31,54

Soplete H-OPTIMUS



Ref.	Código	Características	€/ u.
300020	75800001	Soplete cortador H-OPTIMUS de 90° para OX-AC (sin boquillas)	110,05
300021	75801009	Soplete cortador H-OPTIMUS de 90° de 1 m para OX-AC (sin boquillas)	276,48

Boquilla para cortador H-OPTIMUS



Para Oxígeno-Acetileno. Contiene 5 boquillas.



Ref.	Código	Descripción	€/ u.	Ref.	Código	Descripción	€/ u.
301400	71400201P	Núm. 1, espesor de corte 4-9 mm	45,31	301404	71400205P	Núm. 5, espesor de corte 75-150 mm	45,31
301401	71400202P	Núm. 2, espesor de corte 9-25 mm	45,31	301405	71400206P	Núm. 6, espesor de corte 150-200 mm	45,31
301402	71400203P	Núm. 3, espesor de corte 25-50 mm	45,31	301406	71400207P	Núm. 7, espesor de corte 200-300 mm	45,31
301403	71400204P	Núm. 4, espesor de corte 50-75 mm	45,31				

Boquilla interior de corte



Para Oxígeno-Acetileno. Contiene 5 boquillas.



Ref.	Código	Descripción	€ / u.	Ref.	Código	Descripción	€ / u.
300600	70119201P	Núm. 1 , espesor de corte 2-10 mm	26,60	300602	70119203P	Núm. 3 , espesor de corte 25-30 mm	26,60
300601	70119202P	Núm. 2 , espesor de corte 10-25 mm	26,60	300603	70119204P	Núm. 4 , espesor de corte 30-50 mm	26,60

Soplete aerobutánico



Ref.	Código	Descripción	€ / u.
311000	14600285	Mango soldadura fuerte con economizador	54,02
311001	14600185	Mango soldadura fuerte sin economizador	44,73
311005	14600330	Lanza corta 50 mm para incorporar a mangos para soldadura aerobutánica	25,42
311003	14600430	Lanza larga 200mm para incorporar a mangos para soldadura aerobutánica	27,07
311002	14800030	Soplete chamuscador boquilla Ø 70 mm	58,26

Boquilla aerobutánica para soldadura fuerte



Ref.	Código	Descripción	€ / u.
302904	14600534	Nº 4 de Ø 19 mm. Consumo 260 g/h, 2.875 Kcal/h	25,31
302905	14600535	Nº 5 de Ø 25 mm. Consumo 650 g/h, 7.175 Kcal/h	25,54
302906	14600536	Nº 6 de Ø 29 mm. Consumo 1.200 g/h, 13.260 Kcal/h	26,36
302907	14600537	Nº 7 de Ø 32 mm. Consumo 2.000 gr/h, 22.100 Kcal/h	27,31
302908	14600538	Nº 8 de Ø 42 mm. Consumo 4.100 g/h, 43.305 Kcal/h	48,96



Soplete Monoblock



Mango ergonómico con conexión. Regulador de llama. Quemador 22 mm Ø.
Manguera de alta presión 2 m. Grifo para manguera azul.

Ref.	Código	Descripción	€ / u.
2400829	253000900	Soplete Monoblock 22 Mm	70,45



Soplete Airprop Plus



Soldadura blanda, dura y trabajo por calentamiento. Llama envolvente. Se usa con cartuchos de gas butano y propano. Válvula de ajuste de llama piloto, gatillo de empleo, mango ergonómico.

Ref.	Código	Descripción	€ / u.
2400830	P00508900	Soplete Airprop Plus	109,95



Soplete Eco



Quemador 22 mm Ø. Lanza 100 mm. Mango ergonómico M14X1 con regulador de llama.

Ref.	Código	Descripción	€ / u.
2400831	253000600	Soplete Eco 22Mm	85,45



Soplete MONOBLOCK



Mango con regulador, 2 m. de manguera de alta presión, boquilla Airprop de 22 mm. Ø y conexión salida W21,8.

Ref.	Código	€ / u.
1265500	253000916	70,45



Grifo escape libre y liras propano-butano



Ref.	Código	Descripción	€ / u.
303000	73211116	Conjunto tuerca y racor para grifo escape libre	10,36
303005	73200203	Grifo de escape	20,72
303001	72500230	Lira tubo blindado 8x14 (2,5m)	34,96
303002	72500130	Lira tubo blindado 5x10 (2,5m)	34,96
303003	72500330	Lira tubo sin blindar 6x12 (2,5m)	34,96



Conjunto butano-propano



El conjunto 2 incluye:

14600285 Mango con economizador
14600430 Lanza larga
14600535 Boquilla n°5
14600536 Boquilla n°6
14600537 Boquilla n°7
72500330 6 x 12 (2,50 m) lira de tubo sin blindar

El conjunto 4 incluye:

14600185 Mango sin economizador
73200203 Grifo de escape libre
72500335 6 x 12 (1,50 m) lira de tubo sin blindar
14600534 Boquilla n° 4

Ref.	Código	Descripción	€/ u.
302700	15000030	Conjunto fontanero, pintor y bricolaje N°1	32,37
302701	14600203	Conjunto instalador y electricista N°2	116,52
302703	14600602	Conjunto calefactor-fontanero N°4	84,16



Válvula de seguridad



Ref.	Código	Descripción	€/ u.
302200	73000000	Válvula de seguridad oxígeno, mango 1/4"	20,95
302201	73100020	Válvula de seguridad gases combustibles, mango 3/8" izquierda	20,95
302203	76000000	Válvula de seguridad oxígeno, manorreductor 1/4"	23,07
302204	76200000	Válvula de seguridad gases combustibles, manorreductor 3/8" izquierda	23,07
302206	77000000	Válvula seguridad oxígeno, manguera Ø 6-8	23,07
302207	77100000	Válvula seguridad gases combustibles, manguera Ø 8-10	23,07
302208	77100008	Válvula de seguridad gases combustibles para manguera Ø 6-9	23,07



Tubo de goma



Ref.	Código	Descripción	€/ u.
302300	77200000	Tubo de goma para oxígeno Ø 8 x 16 int/ext	4,35
302301	77300000	Tubo de goma para acetileno Ø 9 x 16 int/ext	4,35
302302	77400000	Tubo de goma para propano Ø 9 x 16 int/ext	4,35
302303	77500000	Manguera bitubo (oxígeno y acetileno/propano) Ø 6 + 6 x 12 int/ext	6,83
302304	77600000	Manguera bitubo (oxígeno y acetileno) Ø 8+ 8 x 15 int/ext	6,83
302305	77900000	Manguera bitubo (oxígeno y propano) Ø 8+ 8 x 15 int/ext	6,83



Alargadera



Ref.	Código	Descripción	€/ u.
302400	72000000	Alargadera para tubo goma G 1/4 RH, desmontable	14,95
302401	72100005	Alargadera para tubo goma G 3/8 LH, desmontable	15,54
302402	72400000	Para tubo de goma Ø 6-8, fija	14,95
302403	72500000	Para tubo de goma Ø 8-10, fija	15,54



Manorreductor modelo EN-2000



Ref.	Código	Caudal nominal (Nm3/h)	Gas	Presión de entrada bar	Presión de salida bar	€/ u.
300030	37000000	30	Oxígeno	200	10	121,35
300031	37500000	5	Acetileno	25	1,5	121,35
300032	37600000	25*	Argón-CO2	200	8	121,35
300033	37300000	5	Propano	25	1,5	121,35



Manorreductor GASWELD



Ref.	Código	Descripción	Caudal nominal (Nm ³ /h)	Presión de entrada bar	Presión de salida bar	€ / u.
300040	30500001	Oxígeno	20	200	10	99,84
300041	31400001	Acetileno	3	25	1,5	99,84
300042	36500001	Argón-CO2	25*	200	10	99,84
300043	32200001	Propano	3	25	1,5	99,84



Soplete Multifire



PACK SOPLETE MULTI FIRE+2 BTN 250 Soplete multiusos piezoeléctrico. Flambear, caramelizar, tostar, dar color y textura a la comida y mejorar la presentación de platos. Encender barbacoas y fuegos bajos. Descongelar tuberías. Trabajos manuales y modelismo.. Pack Multifire + 2 BTN 250

Ref.	Código	Descripción	€ / u.
1280701	1000000419	Pack Multifire + 2 BTN 250	33,45



Candileja ECO



PACK CANDILEJA ECO + 3 CARTUCHOS C200 . Candileja ECO PIEZO + 3 BTP C-200

Ref.	Código	Descripción	€ / u.
1266304	1000000364	Candileja ECO PIEZO + 3 BTP C-200	37,95



Recambio gas



Cartucho desechable con válvula de seguridad.
Se puede conectar y desconectar fácilmente.
Temperaturas extremas de llama, rendimiento máximo en soplete y ahorro garantizado en tiempo de trabajo.
De acuerdo a la norma UN 1077.

Ref.	Código	Descripción	Temperatura °C	€ / u.
1280755	35698	Gas MAPP US	2.400 °C	14,95



Soplete de calentamiento Romini



SOPLETE ROMINI boq.45mm. Lanza 250mm. Incluye boquilla antiviento de 45 mm. Lanza de 250 mm, regulador de llama. Gatillo de seguridad

Ref.	Código	Descripción	€ / u.
1266409	253500100	Soplete con boquilla antiviento	48,95



Soplete Tela Asfáltica



Conexion 3/8"

Ref.	Código	Descripción	€ / u.
2400832	1000003558	Soplete Tela Asfáltica	132,95



Soplete Pro-Fire



Soplete piezoeléctrico profesional para soldadura fuerte con llama envolvente. Ajuste preciso de llama. Diseño especial para un mejor agarre. Indicado para uso con GAS MAPP SUPER-EGO

Ref.	Código	Descripción	€ / u.
2400833	1500002772	Kit Soplete Pro-Fire+2 Botell. Gas Mapp	141,95



Soplete Segofire Piezo



Soldadura blanda, soldadura fuerte y termocontracción. Conexión roscada al depósito de gas [7/16" x 28]. Con cartucho gas butano/propano. BTP 300. Estabilizador de consumo de energía.

Ref.	Código	Descripción	€ / u.
2400834	P00555500	Soplete Segofire Piezo + 3 Bot. Btp300	67,45



Cartucho Romassgas



Cartucho desechable con válvula de seguridad. Se puede conectar y desconectar fácilmente.

Mezcla estabilizada de gas metil-acetileno con propadieno. 35% más rápido que el propano.

Temperatura: 2.400 °C.

Ref.	Código	Descripción	€ / u.
2400835	SEH024600	Cartucho Romassgas Super-Ego	22,45



Soplete Powerfire Compact



Soplete profesional para soldadura fuerte de tuberías de cobre hasta 35 mm con alto contenido de plata en las varillas de soldar. Recomendado para todo tipo de soldadura blanda. Llama envolvente.

Quemador en acero inox de 16 mm Ø.

Efecto Venturi para una mezcla óptima de gas/aire.

Ref.	Código	Descripción	€ / u.
2400836	254800100	Soplete Powerfire Compact+Mapp Us	116,45



Cartucho Btp 300



Cartucho desechable con válvula de seguridad. Se puede conectar y desconectar fácilmente. Contiene combinación 35% propano y 65% butano.

Temperatura: 1.925 °C.

Ref.	Código	Descripción	€ / u.
2400837	SEH020300	Cartucho Btp 300 Super Ego	8,35



Manguera y grifo

Manguera 2M W21,81 R3/8"1

Ref.	Código	Descripción	€ / u.
1266100	251290216	Manguera 2M W21,81 R3/8"1	38,95
1266101	254090116	Grifo para botella azul	14,45



Soplete Rofire

Soplete Rofire con Multi Gas 300 7/16" diámetro 22

Ref.	Código	€ / u.
1266400	35428	47,95



Soplete Rofire Piezo

ROFIRE PIEZO SET Multigas 300, 7/16"-E

Ref.	Código	€ / u.
1266401	35429	52,95



Soplete botella multigas 300

Cartucho multigas 300 (600 ml) con rosca de manguito 7/16"-EU

Ref.	Código	Descripción	€ / u.
1266402	035510-A	Botella multigas 300 ml	7,15



Pack Power- Fire compact

SOPLETE POWERFIRE COMPACT+MAPP US Recomendado también para todo tipo de soldadura blanda. Llama envolvente. Quemador de acero inox de 16 mm. Piezo eléctrico.

Ref.	Código	Descripción	€ / u.
1266407	254800100	Soplete profesional para soldadura fuerte de tubería de cobre hasta 35 mm.	116,45



3250 Soldador eléctrico pistola



Con punta inoxidable de larga duración Dotado con lámpara para iluminación del trabajo.

Ref.	Código	Longitud mm	°C máx.	V	W	€/ u.
1236400	325001000	210x165	400	230	100	83,42



3290 Rollo de estaño



Hilo de estaño de 1,5 mm.

Ref.	Código	%	Longitud mm	€/ u.
1236700	329000330	0.75 Cu 99.25 Sn	2	4,52
1236701	329000500	0.75 Cu 99.25 Sn	4	5,58



Gama INVERTER electrodo



Equipo portátil de tecnología inverter para la soldadura de electrodo revestido (MMA) y proceso TIG DC.



54000100



22290180AC



22300160MMA



22300200MMAVI



22300160PFC



22300160DGT



22300200DGT



22300400E

Ref.	Código	Tensión V/ph	Electrodo mm	Factor de marcha %	Intensidad A	Peso kg	€/ u.
311204	54000100	230/1	4	35	200	5,7	485,51
311206	22290180AC	230/1	4	35	180	4,7	358,83
311207	22290202AC	230/1	4	35	200	5,2	420,64
21044000	22300160MMA	230/1	3,25	35	160	3,2	283,59
21044001	22300200MMAVI	230/1	4	35	200	4,7	357,96
21044002	22300160PFC	230/1	3,25	40	160	6,4	660,66
21044003	22300160DGT	230/1	3,25	35	160	4,2	550,26
21044004	22300200DGT	230/1	4	35	200	4,2	605,28
21044005	22300400E	230-400/ 3	6	60	400	19	2.358,72

Gama INVERTER electrodo



4110



4229

Ref.	Código	Descripción	Tensión V/ph	Electrodo mm	Intensidad A	Rendimiento 40° %	Peso kg	€ / u.
304110	4110	STYL 205 PRO Di	230/1	Hasta 4 mm continuo	200	50	7,5	555,00
304229	4229	ICON 2055 PRO	230/1	Hasta 4 mm continuo	200	50	6,0	635,00

Gama INVERTER electrodo



Soldadura con electrodo MMA (METAL MANUAL ARC).

Este proceso utiliza un electrodo revestido, creando un arco eléctrico cuando entre en contacto con una pieza del mismo material, produciendo un baño de fusión entre ellos. En este baño de fusión se aportará el material del electrodo protegido por revestimiento de este, creando un cordón de soldadura con una capa de escoria.



1.2455



1.2570



1.2668



1.1617



1.1749



1.1750

Ref.	Código	Descripción	Intensidad A	Materiales	Rendimiento 30° %	Peso kg	€ / u.
2400838	1.2455	INVERTER PROGRESS 1200	120	Aceros, inoxidable.	100	2	239,00
2400839	1.2570	INVERTER PROGRESS 1600 K	160	Aceros, inoxidable.	100	2,4	362,00
2400840	1.2668	INVERTER PROGRESS 2021 GEK	200	Aceros, inoxidable y aluminio	100	5	520,00
2400841	1.1617	INVERTER PROGRESS 2100 PFC K	210	Aceros, inoxidable y aluminio	100	8,4	816,00
2400842	1.1749	INVERTER S 250 DV	250	Aceros, inoxidable y aluminio	60	18	1.274.00€
2400843	1.1750	INVERTER S 400 T	400	Aceros, inoxidable y aluminio	60	20	1.950.00€

Equipo a batería electrodo



Nuevo e innovador equipo autónomo de soldadura de electrodo revestido, a batería. Ideal para aquellos trabajos en los que la portabilidad es esencial y no se dispone de alimentación eléctrica en el área de trabajo.



Ref.	Código	Capacidad de la batería	Electrodo mm	Factor de marcha %	Intensidad A	Peso kg	€ / u.
2400844	22300150BT	48 v- 50.000mAh	3.25	10	150	21.6	2.860,00

Gama INVERTER TIG



Ref.	Código	Descripción	Tensión V/ph	Electrodo mm	Electrodo TIG mm	Frecuencia pulsado TIG Hz	Intensidad A	€ / u.
2400845	10464	TIG T-200 PRO	230/1	1,6-4,0	1,6-3,2	2.000	220	1.270,00

Gama INVERTER TIG



Equipo portátil de tecnología inverter para la soldadura de electrodo revestido (MMA) y proceso TIG DC. Alta frecuencia y electroválvula.



50500000



22300400T



22300310ACDCKIT

Ref.	Código	Tensión V/ph	Factor de marcha %	Intensidad A	Peso kg	€ / u.
300051	50500000	230/1	35	200	12,5	2.532,43
21044006	22300400T	230-400/ 3	50	400	30	4.633,20
21044007	22300310ACDCKIT	230-400/ 3	20	315	35	99,84

Gama INVERTER TIG



Soldadura TIG (TUNGSTEN INERT GAS)

Es el proceso de soldadura más estético.

En este proceso se utiliza un tungsteno (electrodo no consumible), que en el momento de crear el arco eléctrico (alta frecuencia, tig por contacto, tig raspado), produce un baño de fusión en la pieza bajo la protección de un gas (argón o helio), pudiendo aportar material con una varilla auxiliar (siendo del mismo material que la pieza a soldar).



2.317



1.2886



1.2887

Ref.	Código	Descripción	Tensión V/ph	Incluye	Intensidad A	Rendimiento %	Peso kg	€ / u.
2400846	2.317	POTENZA TIG 170 HF	230/1	Accesorio antorcha, Maletín	170	60	12.518	690,00
2400847	1.2886	TIG DC 200 HF P	230/1	Accesorio antorcha, Manguera de gas	200	60	14.927	1.295,00
2400848	1.2887	TIG AC/DC 200 HF PULSED	230/1	Accesorio antorcha, Manguera de gas	200	60	28.5	2.163,00

Gama INVERTER TIG



K0013



K0014



K0016



10201



10204

Ref.	Código	Descripción	Tensión V/ph	Incluye	Intensidad A	Rendimiento %	Peso kg	€ / u.
304176	K0013	KIT ICONTIG 1880HF	230/1	Equipo, conjunto masa y antorcha SR-17 4m	180	50	4,9	619,00
304173	K0014	KIT ICONTIG 1990HF PULSE	230/1	Equipo, conjunto masa y antorcha SR-17 4m	180	50	4,9	789,00
304194	K0016	KIT ICONTIG 2220HF PULSE	230/1	Equipo, conjunto masa y antorcha SR-17 4m	220	80	7,2	976,00
356133	10201	KIT AEROTIG 2330HF PULSE	230/1	Equipo, conjunto masa y antorcha SR-26 4m	200	40	14	2.049,00
356134	10204	KIT AEROTIG 4330HF PULSE REF	400/3	Equipo, conjunto masa y antorcha SR-18W 4m	350	40	26	4.990,00

Gama INVERTER TIG AC/DC



Equipo inverter para la soldadura TIG AC/DC. Función auxiliar de soldadura MMA de electrodo revestido. Sistema de cebado TIG AC/DC sin contacto (HF). Sistema automático de estabilización en modo TIG AC (sin HF). Modo pulsado TIG AC/DC. Control de variables de ciclo digital. Control de gas, parámetros de pre-gas y post-gas regulables. Modos de pulsación 2T/4T. Incluye: toma de masa.



Ref.	Código	Tensión V/ph	Factor de marcha %	Intensidad A	Peso kg	€ / u.
300055	22300200TACDC	230/1	25	200	7,18	1.887,60

Gama INVERTER Multifunción



Equipo portátil de tecnología inverter para la soldadura multiproceso (MIG/MAG, MMA y TIG DC). Hilo macizo 0.8-1.0 mm. Arco suave sin proyecciones. Control de inductancia. Cambio de polaridad. Aplicación con hilo animado SIN GAS. Carrete de hilo Ø200 (5 Kg). Carrito accesorio para incorporación con carretes de 15 Kg. Soldadura de electrodo revestido rutilos, básicos, inoxidable. Proceso de soldadura TIG DC (antorcha de válvula manual). Incluye: Tubo de gas, cable masa, cable pinza, careta y cepillo.



Ref.	Código	Alimentación V/ph	Factor de marcha %	Intensidad A	Peso kg	€/ u.
300060	22300200MP	230/1	35	200	9,8	1.141,14
21044008	54300000	230-400/ 3	45	200	18	1.868,25
21044009	22300350MP	230-400/ 3	40	350	51	2.233,66
21044010	22300500MPKIT	230-400/ 3	60	500	35	4.624,62

Gama INVERTER electrodo y TIG



Ref.	Código	Descripción	Tensión V/ph	Electrodo mm	Intensidad A	Rendimiento 40° %	Peso kg	€/ u.
304245	10217	INVERTER CORE 160i	230/1	2,5 continuo y hasta 3,25 mm	160	35	2,8	189,00
304246	10207	INVERTER CORE 200i	230/1	De 3,25 mm y hasta 4 mm	200	35	4,3	269,00
21105002	10096	INVERTER DIRT 200	230/1	Hasta 4 mm continuo	200	50	6	314,00

Gama INVERTER electrodo y TIG



Ref.	Código	Descripción	Tensión V/ph	Electrodo mm	Electrodo TIG mm	Intensidad A	Tecnologías	€/ u.
2400849	10461	INVERTER i-150 E	230/1	1,6-3,25	1,6-3,2	150	Generator OK, Anti STICK, Arc Force, Hot Start	184,00
2400850	10462	INVERTER i-160 E	230/1	1,6-3,25	1,0-2,4	160	Generator OK, Anti STICK, Arc Force, Hot Start	245,00
2400851	10463	INVERTER i-200 E	230/1	1,6-4,0	1,6-4,0	200	Generator OK, Anti STICK, Arc Force, Hot Start	292,00
2400852	10464	INVERTER i-200 E PRO CEL	230/1	1,6-4,0	1,6-3,2	200	Generator OK, Anti STICK, Arc Force, Hot Start, CEL/ALU	380,00

Rectificador electromecánico GAR T



Rectificador de soldadura de electrodo revestido y procedimiento TIG DC.



46886000



2600500



2600600

Ref.	Código	Descripción	Tensión V/ph	Electrodo mm	Factor de marcha %	Intensidad de soldadura A	Peso kg	€/ u.
311301	46886000	GAR 4T	220-380/ 3	6	40	300	123	2.567,40
300065	2600500	GAR 5T	230-400/ 3	6	45	500	160	CONSULTAR
303960	2600600	GAR 6T	230-400/ 3	8	45	600	170	CONSULTAR

Gama MIG compacta



Fuente de potencia MIG/MAG. Máquina compacta.



46900000



43800000



43988000



22300250

Ref.	Código	Tensión V/ph	Diámetro de hilo mm	Factor de marcha %	Intensidad de soldadura A	€/ u.
304411	46900000	230-400/3	1	35	250	1.562,94
304403	43800000	230-400/3	1	35	300	2.085,64
304412	43988000	230-400/3	1,2	35	392	2.748,41
21044011	22300250	230/1	35	250	68	1.938,30

Gama MIG industrial



Fuente de potencia MIG/MAG + Devanadora independiente + Carro porta botellas + Juego de cables



43990000KIT



43100000KIT



42100000KIT



43400000RKIT



43898000KIT

Ref.	Código	Descripción	Tensión V/ph	Diámetro de hilo mm	Factor de marcha %	Intensidad de soldadura A	€/ u.
304001	43990000KIT	GALA MIG 3800	230-400/3	1,2	60	300	2.244,30
304002	43100000KIT	GALA MIG 4007	230-400/3	1,2	60	380	3.180,49
304003	42100000KIT	GALA MIG 5100	230-400/3	1,2	60	425	4.348,66
304004	43400000RKIT	GALA MIG 6007	230-400/3	1,6	60	550	6.513,64
21044012	43898000KIT	GALA MIG 3000	230-400/3	1	35	300	2.788,43

Máquina de hilo



10466



10467



10468

Ref.	Código	Descripción	Tensión V/ph	Bobina de hilo máx	Ø hilo mm	Intensidad A	Electrodo mm	Electrodo TIG mm	Dotación	Tecnologías	€ / u.
2400853	10466	MIG M-200	230/1	D300-15kg	0,6-1,2	200	1,6-4,0	1,6-3,2	Máquina, conjunto masa y antorcha SX-25 4 m	Digital, Gas/No gas, Multiprocess, Sinergic, TIG lift.	1.780,00
2400854	10467	MIG M-300 C	400/3	D300-15kg	0,6-1,2	320	1,6-4,0	1,6-3,2	Máquina, conjunto masa y antorcha SX-36 4 m	Wifi, WAAS, Wi Panel, Geolocalización	3.800,00
2400855	10468	MIG M-400 PULSE DVW	400/3	D300-15kg	0,6-1,2	400	1,6-4,0	1,6-3,2	Máquina, conjunto masa y antorcha SX-501 4 m	Wifi, WAAS, Wi Panel, Geolocalización	7.870,00

Máquina de hilo



10132

54004

K0222



10109



10212



10107

Ref.	Código	Descripción	Tensión V/ph	Incluye	Ø hilo mm	Posiciones regulación	Rango intensidad A	Rendimiento %	Peso kg	€ / u.
2400856	10132	SOLMIG 170i	230/1	Equipo, conjunto masa y antorcha SX-15 2 m	0,6-0,8	Sinérgica	20 - 150	35	7,7	399,00
354004	54004	SOLMIG 180	230/1	Equipo, conjunto masa y antorcha SX-15 3 m	0,6-0,8-1	6	30 - 180	15	48	700,00
356168	K0222	KIT AEROPROCESS 2000 1mm	230/1	Equipo, conjunto masa y antorcha SX-25 4 m	0,6-0,8-1	Sinérgica	20 - 200	45	19	1.242,00
356169	10109	KIT AEROPROCESS 320C	400/3	Equipo, conjunto masa y antorcha SX-25 4 m	0,6-0,8-1-1,2	Sinérgica	20 - 320	40	36	2.790,00
356175	10212	KIT AEROPROCESS 400 DV	400/3	Equipo, conjunto masa, antorcha SX-36 4 m, carro carro, conexión devanador 5m	0,6-0,8-1-1,2-1,6	Sinérgica	10 - 420	45	65	4.164,00
21105001	10107	KIT AEROPROCESS 400DV W	400/3	Equipo, conjunto masa, antorcha SX-501 4 m, carro, conexión devanador 5m.	0,6-0,8-1-1,2-1,6	Sinérgica	10 - 400	35	85	5.242,00

Máquina de hilo



Soldadura con hilo MIG /MAG (METAL INERT GAS/ METAL ACTIVE GAS) / Soldadura con hilo SIN GAS (MIG 131)

Este proceso crea un arco eléctrico producido por el avance de un hilo continuo que se funde al entrar en contacto con una pieza del mismo material. Este baño de fusión puede ser protegido por un gas inerte (argón, helio), un gas activo (dióxido de carbono, oxígeno) o sin gas en el caso del hilo flux.



2682



12688



1739



12678



12401



12679

Ref.	Código	Descripción	Tensión V/ph	Ø hilo mm	Posiciones regulación	Rango intensidad A	Rendimiento %	Peso kg	€ / u.
2400857	12682	MIG 131	230/1	0,9-1,0	Sinérgica	20-120	30	4,9	385,00
2400858	12688	MIG 165 MULTI	230/1	0,6-1,0	Sinérgica	20-160	60	13	669,00
2400859	1739	MIG 200 MULTI	230/1	0,8-1,0	Manual	10-200	60	22	1.489,00€
2400860	12678	MIG 200 DOUBLE PULSED	400/3	0,8-1,0-1,2	Sinérgica	20-200	60	17,5	2.105,00€
2400861	12401	MIG 280 DUAL PULSED	400/3	0,8-1,0-1,2-1,6	Sinérgica	20-280	60	34	2.832,00€
2400862	12679	MIG 350 DOBLE PULSO	400/3	0,8-1,0-1,2-1,6	Sinérgica	20-350	60	46,5	3.900,00€

Gala Pulse Synergic 2300



Equipo Multiproceso de soldadura MIG/MAG - TIG DC - MMA - Procesos: MIG/MAG Pulse / Bi-Pulse - Tubular sin Gas TIG Lift Arc - TIG Pulse - MMA y MMA CEL - Materiales base y aleaciones: Acero al carbono, inoxidable, aluminio, cobre. - Aplicaciones: Carpintería metálica media - Industria del automóvil Industria química y papelera - Fabricación de carrocerías Instalaciones deportivas y ganaderas - Mobiliario urbano Mantenimiento - Construcción - Centros de formación Instituciones públicas - Automatización



Ref.	Código	Descripción	Tensión V/ph	Factor de marcha %	Intensidad A	Peso kg	€ / u.
303992	53200000	Synergic 2300	230/1	40	200	25	3.829,72

Gama MMA sinérgico



Equipo portátil para la soldadura en corriente continua de electrodo revestido MMA y TIG DC. Tecnología IGBT inverter de alto rendimiento.



Ref.	Código	Tensión V/ph	Factor de marcha %	Intensidad A	Peso kg	€ / u.
2400863	22300120MS	230/1	35	120	2,5	185,00

Gala Cleaner Basic



Equipo portátil de uso sencillo y seguro para limpieza de superficies soldadas mediante la aplicación de ácidos e hidrólisis sobre los cordones de soldadura. Limpieza de la totalidad de superficies soldadas, especialmente para soldadura TIG sobre aceros inoxidable.

Ref.	Código	Tensión V/ph	Tensión de salida	Potencia máxima P1max / P1eff	Peso kg	€ / u.
2400864	52500000	230/1	12 V	150 VA	5	1.118,15



Gala Cleaner 800



Equipo portátil de uso sencillo y seguro para la limpieza de superficies soldadas mediante la aplicación de ácidos e hidrólisis sobre los cordones de soldadura. Además incorpora sistema de marcado electroquímico de uso industrial (Opcional)

Ref.	Código	Tensión V/ph	Tensión de salida	Potencia máxima P1max / P1eff	Peso kg	€ / u.
2400865	52800000	230/1	9 V	150 W	10.5	1.790,00



Gala Spot



Máquinas de soldadura por puntos

Ref.	Código	Tensión V/ph	Capacidad de soldadura	Modelo	Profundidad de brazos mm	€ / u.
305150	29080001	400/2	4+4	30 Mecánica	340-380	5.177,33
305151	29080002	400/2	4+4	30 Neumática	340-380	5.717,40
305152	29080003	400/2	5+5	50 Mecánica	340-380	5.408,79
305153	29080004	400/2	5+5	50 Neumática	340-380	5.961,03



Gama Solspot



10367



10368

Ref.	Código	Descripción	Alimentación V/ph	Kva Max	Amp Max	Tiempo soldadura	Peso kg	€ / u.
2400866	10367	SOLSPOT 5000 STEEL + KIT STUDDER	230/1	12	1.800	0,5--9	16	830,00
2400867	10368	SOLSPOT 9000 + PINZA NEUMATICA + KIT STUDDER	400/1	50	8.000	1-99	105	3.990,00

Gama Plasma



Ref.	Código	Descripción	Tensión V/ph	Factor de marcha %	Intensidad máxima de corte A	Peso kg	€ / u.
21044014	2230045PFC	Smart CUT 45 PFC	230/1	35	45	10	1.418,62
300070	46300000	GALA CUT 700	400/3	60	70	25	3.867,27
303901	50900000	GALA CUT 350 K	230/1	35	35	25	3.091,74

Gama Plasma



Ref.	Código	Descripción	Alimentación V/ph	Compresor	Intensidad 30A @	Capacidad corte max mm	Peso kg	€ / u.
2400868	10351	SOLCUT 5000K PFC	230/1	Incluido	1	8	20	1.399,00
2400869	10360	SOLCUT 6000K PFC DUAL	230/1	Incluido	0.35	10	23	1.699,00
2400870	10133	SOLCUT 50	230/1	Externo	0.5	12	12	1.199,00
2400871	14012	SOLCUT 60 PRO	400/3	Externo	0.4	22	18	1.690,00
2400872	14011	SOLCUT 100	400/3	Externo	0.6	30	30	2.790,00

Gama Plasma



CORTE POR PLASMA

Es un proceso de corte por sobrecalentamiento y aire.

La formación del arco comienza cuando el aire introducido es forzado a través de una boquilla dentro de un soplete que, junto a la generación de un arco eléctrico a partir de una fuente de alimentación externa, genera un flujo a alta presión. Esta mezcla de aire y arco eléctrico realiza un proceso de corte sobre una pieza de metal.



Ref.	Código	Descripción	Peso kg	€ / u.
2400873	1.1732	PLASMA MULTI 40	14.598	1.285.00€
2400874	1.1537	PLASMA 40 COM GE	22.024	1.645.00€
2400875	1.1538	PLASMA 100 T GE	32	3.079.00€

Aspirador de humos de soldadura



Ref.	Código	Descripción	€ / u.
305201	7603001400	Estación móvil alto vacío PHV con tubo de extracción EN-20	CONSULTAR
21044015	111449	Aspirador portátil + Brazo flexible (2 m. - Ø160 mm. - Filtro de 15 m2)	CONSULTAR
21044016	111470	Aspirador portátil + Brazo flexible (3 m. - Ø160 mm. - Filtro de 15 m2)	CONSULTAR
21044017	111476	Aspirador fijo de monobrazo flexible de 3 m.- Ø160 mm.	CONSULTAR
21044018	111488	Aspirador fijo de monobrazo flexible de 4 m.- Ø160 mm.	CONSULTAR

Estufa vertical DHF-5T



Con termómetro y termostato. Capacidad máxima de electrodos 5 kg - Temp. 50-300 °C

Ref.	Código	Dimensiones cm	Peso kg	€ / u.
300080	1705V5	24x22x68	5,5	364,94



Horno para secado de electrodos



Ref.	Código	Descripción	€ / u.
305405	1724000	Horno GE-24 hasta 200 OC	4.402,00
305406	1724001	Horno GE-24 hasta 300 OC	5.034,29
305407	1724002	Horno GE-24 hasta 350 OC	6.035,17



Pinza portaelectrodos



Ref.	Código	Descripción	€ / u.
305500	68500000	200 A. Abierta	6,54
305501	67000000	400 A. Cerrada	12,08
305502	67100000	400 A. Abierta	10,95
305503	68600000	500 A. Cerrada	16,61
305504	68200000	500 A. Abierta	14,47



68500000



67100000



68200000

Toma de masa



Ref.	Código	€ / u.
305600	67300020	2,77
305601	67300000	6,04
305602	67300500	7,80



67300000



67300500

Empalme para cable Solda



Ref.	Código	Descripción	€/ u.
305800	60400000	Empalme rápido 10-25 hembra	5,15
305801	58416328	Empalme rápido 10-25 macho	5,15
305802	60500000	Empalme rápido 35-50 hembra	5,72
305803	47716036	Empalme rápido 35-50 macho	5,72

Ref.	Código	Descripción	€/ u.
305804	60600000	Empalme rápido 50-70 hembra	8,24
305805	60700000	Empalme rápido 50-70 macho	8,24
305806	60800000	Empalme rápido 70-95 hembra	13,27
305807	60900000	Empalme rápido 70-95 macho	13,27

Cable Solda



Ref.	Código	Descripción	€/ u.
305900	130042	Cable 1 x 16 mm ²	CONSULTAR
305901	130044	Cable 1 x 25 mm ²	CONSULTAR
305902	130045	Cable 1 x 35 mm ²	CONSULTAR
305903	130047	Cable 1 x 50 mm ²	CONSULTAR
305904	130048	Cable 1 x 70 mm ²	CONSULTAR



Antorcha soldadura MIG-ECO



880015P



880025P



880036P



880501P

Ref.	Código	Descripción	€/ u.
300085	880015P	Antorcha mig 15, 4 metros	82,88
300086	880025P	Antorcha mig 25, 4 metros	109,99
300087	880036P	Antorcha mig 36, 4 metros	149,20
300088	880501P	Antorcha mig 501, 4 metros, refrigerada por agua	223,13

Antorcha MIG 7XM-501



Ref.	Código	Descripción	€/ u.
306725	8805013P	Antorcha MIG refrigerada por agua, 3m, 500 A	204,20



Repuestos para antorcha MIG 7XM-501

	Cuello	Porta-tubo M8	Difusor	Difusor especial	Tubo contacto 0,8 mm	Tubo contacto 1,1 mm	Tubo contacto 1,2 mm	Tubo contacto 1,6 mm	Tobera cónica	Aislante cuello
Ref.	306730	306731	306733	306734	306735	306736	306737	306738	306739	306740
Código	5857	6347B5	5858B5	88300570	5741B10	6134B10	6131B10	6135B10	5875B3	88305640
Unidades	1	5	5	1	10	10	10	10	3	1
€/ u.	36,61	7,44	2,63	1,37	9,50	8,24	8,69	8,81	14,19	0,92

Antorcha TIG 5XT-17



Ref.	Código	€ / u.
306750	T174030	293,57
306751	T178030	380,30



Repuestos para antorcha XT-17

	Cuerpo antorcha estandar XT-17	Cuerpo antorcha estandar XT-17V	Capuchón largo	Capuchón medio	Capuchón corto
Ref.	306755	306757	306759	306760	306765
Código	190520200	190520201	6297	19500347	6280
Unidades	1	1	1	1	1
€ / u.	16,24	26,88	2,86	1,72	1,72

Antorcha MIG 400 4m.



Ref.	Código	Descripción	€ / u.
21044019	PK4012	Antorcha para soldadura MIG 4 metros / 300 A	230,85



Repuestos para Antorcha MIG 400

Ref.	21044020	21044021	21044022	21044023	21044024	21044025	21044026	21044027
Código	PK401462	PK403145	PK4043	PK41511610B	PK40560	PK41312	PK30017K	PK4111
Unidades	3	5	3	1	1	1	1	1
€ / u.	10,87	1,37	6,52	9,38	33,75	241,61	10,07	12,47

Antorcha TIG 5XT-26



Ref.	Código	Descripción	€ / u.
306780	19052614P	Antorcha para soldadura TIG, 4m, 35-50mm ² , 130 A	158,19
306781	19052604P	Antorcha para soldadura TIG -V, 4m 35-50mm ² , 130 A	158,19
306782	19052634P	Antorcha para soldadura TIG, 4m, 130 A. Euroconector	267,98



Repuestos para antorcha XT-26

	Cuerpo antorcha estandar XT-26	Cuerpo antorcha estandar XT-26V	Capuchón largo XT-26	Capuchón medio XT-26	Capuchón cortoXT-26
Ref.	306810	306812	306814	306815	306820
Código	190520600	190520601	6297	19500347	6280
Unidades	1	1	1	1	1
€ / u.	23,80	68,98	2,86	1,72	1,72

Antorcha TIG 5XT-18



Ref.	Código	€ / u.
306785	19051814P	195,94
306786	T184030	397,72



Repuestos para antorcha XT-18

	Cuerpo antorcha estandar XT-18	Capuchón largo XT-18	Capuchón medio XT-18	Capuchón corto XT-18
Ref.	306830	306832	306833	306834
Código	190520300	6297	19500347	6280
Unidades	1	1	1	1
€ / u.	25,05	2,86	1,72	1,72

Repuestos para antorcha XT 17/18/26



	Porta-electrodo 1.0mm	Porta-electrodo 1.6mm	Porta-electrodo 2.0mm	Porta-electrodo 2.4mm	Porta-electrodo 3.2mm	Porta-electrodo 4.0mm
Ref.	306855	306856	306857	306858	306859	306860
Código	6300B10	6449B10	6450B10	6451B10	6452B10	6453B10
Unidades	5	5	5	5	5	5
€ / u.	6,86	6,86	6,86	6,86	6,86	6,86



	Porta-tobera 1.0mm	Porta-tobera 1.6mm	Porta-tobera 2.0mm	Porta-tobera 2.4mm	Porta-tobera 3.2mm	Porta-tobera 4.0mm
Ref.	306865	306866	306867	306868	306869	306870
Código	6299B10	6455B10	6507B10	6456B10	6457B10	6458B10
Unidades	5	5	5	5	5	5
€ / u.	12,36	12,36	12,36	12,36	12,36	12,36



	Tobera cerámica 6.4mm	Tobera cerámica 7.9mm	Tobera cerámica 9.5mm	Tobera cerámica 11.1mm	Tobera cerámica 12.7mm	Tobera cerámica 16.0mm	Tobera cerámica 19.0mm
Ref.	306875	306876	306877	306878	306879	306880	306881
Código	6298B10	6444B10	6445B10	6446B10	6447B10	6510B10	19500532B10
Unidades	5	5	5	5	5	5	5
€ / u.	5,72	5,72	5,72	5,72	5,72	5,72	5,72



Electrodos de Tungsteno



Cajas de 10 unidades.



	Verde Puro	Rojo 2% torio	Gris Cerio	Negro Lantano	Oro Lantano
Ref.	306910	306912	306913	306914	306916
Código	750100C	750102C	750103C	750104C	750106C
Ø mm	1,0	1,0	1,0	1,0	1,0
€ / u.	17,39	22,31	17,39	24,37	17,39

	Verde Puro	Rojo 2% torio	Gris Cerio	Negro Lantano	Oro Lantano
Ref.	306920	306922	306923	306924	306926
Código	750160C	750162C	750163C	750164C	750166C
Ø mm	1,6	1,6	1,6	1,6	1,6
€ / u.	20,82	26,08	20,94	27,11	22,65

	Verde Puro	Rojo 2% torio	Gris Cerio	Negro Lantano	Oro Lantano
Ref.	306930	306932	306933	306934	306936
Código	750200C	750202C	750203C	750204C	750206C
Ø mm	2,0	2,0	2,0	2,0	2,0
€ / u.	36,49	43,36	36,61	45,19	38,21

	Verde Puro	Rojo 2% torio	Gris Cerio	Negro Lantano	Oro Lantano
Ref.	306940	306942	306943	306944	306946
Código	750240C	750242C	750243C	750244C	750246C
Ø mm	2,4	2,4	2,4	2,4	2,4
€ / u.	43,47	52,17	43,47	53,67	46,90

	Verde Puro	Rojo 2% torio	Gris Cerio	Negro Lantano	Oro Lantano
Ref.	306950	306952	306953	306954	306956
Código	750320C	750322C	750323C	750324C	750326C
Ø mm	3,2	3,2	3,2	3,2	3,2
€ / u.	74,82	87,52	74,70	91,22	78,59

	Verde Puro	Rojo 2% torio	Gris Cerio	Negro Lantano	Oro Lantano
Ref.	306960	306962	306963	306964	306966
Código	750400C	750402C	750403C	750404C	750406C
Ø mm	4,0	4,0	4,0	4,0	4,0
€ / u.	121,49	142,54	121,49	121,49	121,49

Rutilo

Ref.	Código	Dimensiones mm	Norma	€/u.
309600	7160520Z	2 x 300	E-6013	CONSULTAR
309601	7160525E	2,5 x 350	E-6013	CONSULTAR

Ref.	Código	Dimensiones mm	Norma	€/u.
309602	716053M	3,25 x 350	E-6013	CONSULTAR
309603	7160540V	4 x 350	E-6013	CONSULTAR

Básico

Ref.	Código	Dimensiones mm	Norma	€/u.
309700	7081225J	2,5 x 350	E-7018	CONSULTAR
309701	7081232R	3,25 x 450	E-7018	CONSULTAR
309702	7081240A	4 x 450	E-7018	CONSULTAR

Ref.	Código	Dimensiones mm	Norma	€/u.
309703	7081825L	2,5 x 350	E-7016	CONSULTAR
309704	7081533T	3,25 x 450	E-7016	CONSULTAR
309705	7081840C	4 x 450	E-7016	CONSULTAR

Hierro fundido

Ref.	Código	Dimensiones mm	Norma	€/u.
309900	7280525G	2,5 x 350	E-NiCl	CONSULTAR
309901	7280532P	3,25 x 350	E-NiCl	CONSULTAR
309902	10810574	4 x 350	E-NiCl	CONSULTAR

Aluminio

Ref.	Código	Dimensiones mm	Norma	€/u.
310000	7420025U	2,5 x 355	E-ALSi12	CONSULTAR
310001	7420032C	3,25 x 355	E-ALSi12	CONSULTAR

Inoxidable

Ref.	Código	Dimensiones mm	Norma	€/u.
309800	7281320D	2 x 300	E-308L-16	CONSULTAR
309801	7281325J	2,5 x 300	E-308L-16	CONSULTAR

Ref.	Código	Dimensiones mm	Norma	€/u.
309802	7281332R	3,25 x 350	E-308L-16	CONSULTAR
309803	7281340A	4 x 350	E-308L-16	CONSULTAR

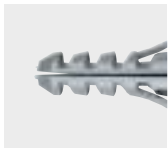

550
Tacos de nylon



574
Grapas

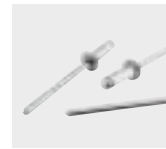

583
Remaches

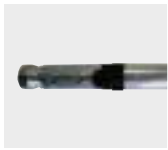

555
Anclajes metálicos



575
Grapa puente



591
Tornillería hexagonal



555
Anclajes metálicos inox



561
Abrazaderas colgantes



595
Tornillería Allen. DIN 912

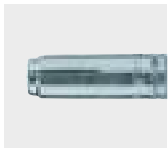

558
Anclaje de expansión



577
Abarcones



596
Tornillería Allen. DIN 7984



558
Fijadores de inyección



577
Grapillas



597
Tornillería Allen. DIN 7991



559
Ampolla de mortero



578
Bridas nylon



599
Tornillería Allen. Espárragos

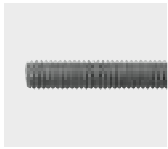

560
Anclajes químicos Varilla FIS A



578
Impulsión polvora



603
Tornillería metal. DIN 963



561
Abrazaderas isofónicas

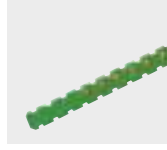

579
Impulsores de polvora

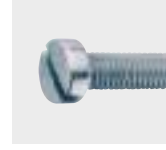

604
Tornillería metal. DIN 84



562
Abrazaderas alambre



580
Clavos

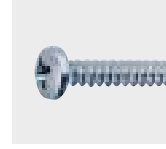

607
Tornillería rosca chapa. Philips



563
Abrazaderas metálicas



581
Puntas de acero



608
Autorroscantes para chapa



574
Abrazaderas metálicas P-clip

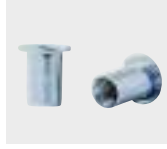

587
Tuercas remachables



610
Tornillos barraqueros DIN 571



610

Tornillos madera
y aglomerado



612

Tornillos
carrocero



613

Tornillos
de ojo



613

Tornillos
DIN 480



614

Varillas
roscadas

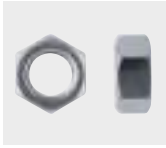

614

Tuercas
hexagonales

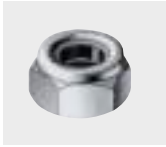

615

Tuercas
varias



617

Tuercas
soldables



617

Tuercas
rápidas



621

Arandelas



622

Arandelas
DIN 6798

06

FIJACIÓN

Taco S universal



BASE DE ANCLAJE
MATERIAL MACIZO



Ref.	Código	Tipo	Broca Ø mm	Longitud taco mm	Prof. mín. taladro mm	Tornillo rosca madera de/hasta Ø mm	€/100
800100	50104	S 4	4	20	25	2-3	7,42
800101	50105	S 5	5	25	35	3-4	4,42
800102	50106	S 6	6	30	40	4-5	5,54
800103	56106	S 7	7	30	40	4-5,5	8,48
800104	50108	S 8	8	40	55	4,5-6	10,40
800105	50110	S 10	10	50	70	6-8	9,21
800106	50112	S 12	12	60	80	8-10	9,23
800107	50114	S 14	14	75	90	10-12	13,18
800108	50116	S 16	16	80	100	12-[1/2']	9,58
800109	50120	S 20	20	90	120	16	16,81

Taco DUOPOWER



Nuevo taco fischer con tecnología 2K. Máximas cargas para todos los materiales.

BASE DE ANCLAJE
MATERIAL MACIZO

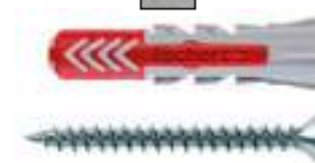

Ref.	Código	Tipo	Broca Ø mm	Profundidad mínima del taladro mm	Espesor mín. tablero mm	Longitud mín. tornillo mm	Tornillo rosca madera y aglomerado mm	€/100
800710	555005	DUOPOWER 5x25 / 100C	5	35	12,5	28	3-4	5,95
800711	555006	DUOPOWER 6x30 / 100C	6	40	12,5	34	4-5	8,10
800712	555008	DUOPOWER 8x40 / 100C	8	50	12,5	45	4,5-6	12,11
800713	555010	DUOPOWER 10x50 / 50C	10	60	12,5	56	6-8	11,66
800714	555106	DUOPOWER 6x30 S / 50C	6	40	12,5	34	4,5x40	10,87
8000219	555108	DUOPOWER 8x40 S / 50C	8	50	12,5	45	5,0x60	15,52

Taco SINEX



Taco de nylon de 4 segmentos para todo tipo de materiales. Estuche con ventana



Ref.	Código	Broca Ø mm	Profundidad mínima del taladro mm	€/100
8005368	05SISX	5	25	1,41
8005369	06SISX	6	30	1,46
8005370	08SISX	8	40	2,42
8005371	10SISX	10	50	4,20
8005372	12SISX	12	60	9,32

Taco SINEX



Taco de nylon de 4 segmentos para todo tipo de materiales. Envase de plástico.



Ref.	Código	Broca Ø mm	Pzs	Profundidad mínima del taladro mm	€/ u.
8005373	06SISXP	6	1.000	30	13,58
8005374	08SISXP	8	500	40	11,84

Taco universal UX



Fija también en pladur

Ref.	Código	Tipo	Broca Ø mm	Espesor mín. de tablero mm	Prof. mín. taladro mm	Tornillo rosca madera o aglomerado de/hasta Ø mm	€/100
801400	94721	UX 5 x 30	5	9,5	40	3-4	7,86
801401	62754	UX 6 x 35	6	9,5	45	4-5	11,84
801402	72094	UX 6 x 50	6	9,5	60	4-5	12,75
801403	77869	UX 8 x 50	8	9,5	60	4,5-6	16,56
801404	77871	UX 10 x 60	10	12,5	75	6-8	15,10
801405	62758	UX 12 x 70	12	-	85	8-10	12,24
801406	62757	UX 14 x 75	14	-	95	10-12	15,30
801407	94722	UX 5 x 30 R	5	9,5	40	3-4	7,84
801408	62756	UX 6 x 35 R	6	9,5	45	4-5	11,97
801409	72095	UX 6 x 50 R	6	9,5	60	4-5	12,86
801412	505483	UX 8 x 40 R	8	9,5	50	4,5-6	16,09
801410	77870	UX 8 x 50 R	8	9,5	60	4,5-6	16,56
801411	77872	UX 10 x 60 R	10	12,5	75	6-8	15,03

Con tornillo

Ref.	Código	Tipo	Broca Ø mm	Espesor mín. a fijar mm	Ø x L mm	Prof. mín. taladro mm	€/100
801500	94758	UX 6 x 35 R S/20	6	35	4,5 x 60	60	12,58
801501	94759	UX 6 x 50 R S/20	6	50	4,5 x 75	75	13,35
801503	94760	UX 8 x 50 R S/20	8	50	5 x 80	80	15,56
801504	94761	UX 10 x 60 R S/20	10	60	6 x 85	85	16,30

Taco N con clavo roscado, premontado



Ref.	Código	Tipo	Broca Ø mm	Clavo roscado Ø mm	Espesor máx. a fijar mm	Longitud taco mm	Prof. mín. anclaje mm	€/100
800302	50351	N 5x40/15 S	5	3,5 x 48	15	40	25	17,93
800303	50352	N 5x50/25 S	5	3,5 x 58	25	50	25	16,98
800304	50354	N 6x40/10 S	6	4 x 48	10	40	30	11,08
800305	50355	N 6x60/30 S	6	4 x 68	30	60	30	12,11
800306	50353	N 6x80/50 S	6	4 x 88	50	80	30	18,35
800309	50357	N 8x100/60 S	8	5 x 108	60	100	40	23,30
800310	50359	N 8x120/80 S	8	5 x 128	80	120	40	26,82
800307	50356	N 8x60/20 S	8	5 x 68	20	60	40	16,60
800308	50358	N 8x80/40 S	8	5 x 88	40	80	40	17,79
800311	50346	N 10x100/50 S	10	7 x 110	50	100	50	50,95
800313	50348	N 10x160/110 S	10	7 x 170	110	160	50	88,35

Taco N-Z-A2, con clavo roscado inoxidable A2 (AISI 304)

Ref. INOX	Código INOX	Tipo	Broca Ø mm	Clavo roscado Ø mm	Espesor máx. a fijar mm	Longitud taco mm	Prof. mín. anclaje mm	€/100
800501	50372	N 6 x 40 A2	6	4 x 48	10	40	30	24,85
800502	50373	N 6 x 60 A2	6	4 x 68	30	60	30	29,60
800504	50375	N 8 x 80 A2	8	5 x 88	40	80	40	57,60
800505	50376	N 8 x 100 A2	8	5 x 108	60	100	40	79,15

Taco N-FZ, con reborde plano y clavo roscado

Ref.	Código	Tipo	Broca Ø mm	Clavo roscado Ø mm	Espesor máx. a fijar mm	Longitud taco mm	Prof. mín. anclaje mm	€/100
800600	50338	N 5 x 30 FZ	5	3,5 x 38	5	30	25	17,04
800601	50339	N 6 x 40 FZ	6	4 x 48	7	40	30	11,73

Taco largo multimaterial SXR-T



SXR-T con tornillo de cabeza avellanada con engarce T-30 o T-40, de acero zincado

Ref.	Código	Tipo	Broca Ø mm	Espesor máx. a fijar mm	Longitud taco mm	Prof. mín. anclaje mm	€/100
814600	503000	SXR 8x80 T	8	30	80	90	46,50
814601	503001	SXR 8x100 T	8	50	100	110	57,25
814603	46263	SXR 10x80 T	10	30	80	90	70,80
814604	46264	SXR 10x100 T	10	50	100	110	79,80

Acero inoxidable A4 (AISI 316)

Ref. INOX	Código INOX	Tipo	Broca Ø mm	Espesor máx. a fijar mm	Longitud taco mm	Prof. mín. anclaje mm	€/100
814701	46274	SXR 10x100 T A4	10	50	100	110	268,00

Taco largo multimaterial SXR sin tornillo



Ref.	Código	Tipo	Broca Ø mm	Espesor máx. a fijar mm	Longitud taco mm	Prof. mín. anclaje mm	€/100
815102	506194	SXR 8x60	8	10	60	70	26,27
815103	506196	SXR 8x80	8	30	80	90	31,31
815104	506198	SXR 8x100	8	50	100	110	53,30

Taco largo multimaterial SXR FUS



SXR FUS con tornillo de cabeza hexagonal con arandela unida por moldeo y engarce T-40

Ref.	Código	Tipo	Broca Ø mm	Espesor máx. a fijar mm	Longitud taco mm	Prof. mín. anclaje mm	€/100
814801	46329	SXR 10x60 FUS	10	10	60	70	65,20
814802	46330	SXR 10x80 FUS	10	30	80	90	70,40
814803	46331	SXR 10x100 FUS	10	50	100	110	79,10

Acero inoxidable A4 [AISI 316]

Ref. INOX	Código INOX	Tipo	Broca Ø mm	Espesor máx. a fijar mm	Longitud taco mm	Prof. mín. anclaje mm	€/100
814900	46339	SXR 10x60 FUS A4	10	10	60	70	235,35
814901	46340	SXR 10x80 FUS A4	10	30	80	90	284,00

Taco largo multimaterial SXRL-T. Acero zincado



SXRL-T con tornillo de cabeza avellanada con engarce T-40, de acero zincado

Ref.	Código	Tipo	Broca Ø mm	Longitud mm	Min. longitud de anclaje h2	Longitud útil para Hef=70	Longitud útil para Hef=90	€/100
822698	522698	SXRL 10x80 T	10	80	90	10	-	86,85
822699	522699	SXRL 10x100 T	10	100	110	30	10	98,55
822700	522700	SXRL 10x120 T	10	120	130	50	30	114,80
822701	522701	SXRL 10x140 T	10	140	150	70	50	139,60
822703	522703	SXRL 10x160 T	10	160	170	90	70	181,65
822704	522704	SXRL 10x180 T	10	180	190	110	90	277,50

SXRL-T con tornillo de cabeza avellanada con engarce T-40, de acero inoxidable

Ref. INOX	Código INOX	Tipo	Broca Ø mm	Longitud mm	Min. longitud de anclaje h2	Longitud útil para Hef=70	Longitud útil para Hef=90	€/100
822709	522709	SXRL 10x80 T	10	80	90	10	-	387,50
822710	522710	SXRL 10x100 T	10	100	110	30	10	410,50
822711	522711	SXRL 10x120 T	10	120	130	50	30	427,00

Taco largo multimaterial SXRL-T. Acero zincado



SXRL FUS con tornillo de cabeza avellanada con engarce T-40/SW13, de acero zincado

Ref.	Código	Tipo	Broca Ø mm	Longitud mm	Min. longitud de anclaje h2	Longitud útil para Hef=70	Longitud útil para Hef=90	€/100
822719	522719	SXRL 10x80 FUS	10	80	90	10	-	98,55
822720	522720	SXRL 10x100 FUS	10	100	110	30	10	107,45
822721	522721	SXRL 10x120 FUS	10	120	130	50	30	124,35
822723	522723	SXRL 10x140 FUS	10	140	150	70	50	150,70
822724	522724	SXRL 10x160 FUS	10	160	170	90	70	164,05
822725	522725	SXRL 10x180 FUS	10	180	190	110	90	196,80

SXRL FUS con tornillo de cabeza avellanada con engarce T-40/SW13, de acero inoxidable

Ref. INOX	Código INOX	Tipo	Broca Ø mm	Longitud mm	Min. longitud de anclaje h2	Longitud útil para Hef=70	Longitud útil para Hef=90	€/100
822730	522730	SXRL 10x80 FUS	10	80	90	10	-	463,50
822731	522731	SXRL 10x100 FUS	10	100	110	30	10	473,50
822732	522732	SXRL 10x120 FUS	10	120	130	50	30	538,00

Taco SX Plus



Nuevo taco fischer evolución SX



Ref.	Código	Tipo	Broca Ø mm	Longitud taco mm	Prof. mín. taladro mm	€/100
2400876	568004	SX Plus 4 x 20	4	20	25	9,84
2400877	568005	SX Plus 5 x 25	5	25	35	5,26
2400878	568006	SX Plus 6 x 30	6	30	40	7,17
2400879	568008	SX Plus 8 x 40	8	40	50	10,72
2400880	568010	SX Plus 10 x 50	10	50	70	10,24
2400881	568012	SX Plus 12 x 60	12	60	80	8,81
2400882	568014	SX Plus 14 x 70	14	70	90	13,20

Taco DuoXpand



Nuevo taco largo multimaterial bicomponente



Ref.	Código	Tipo	Cabeza	Engarce TORX	Longitud taco mm	Prof. mín. anclaje mm	Prof. mín. taladro mm	€/100
2400883	562149	DuoXpand 8 x 80 T	8	T30	80	70	90	57,30
2400884	562150	DuoXpand 8 x 100 T	8	T30	100	70	110	69,45
2400885	562151	DuoXpand 8 x 120 T	8	T30	120	70	130	80,80
2400886	562163	DuoXpand 10 x 80 T	10	T40	80	70	90	325,00
2400887	562164	DuoXpand 10 x 100 T	10	T40	100	70	110	344,50
2400888	562166	DuoXpand 10 x 140 T	10	T40	140	70	150	504,00
2400889	562155	DuoXpand 10 x 80 T	10	T40	80	70	90	76,00
2400890	562156	DuoXpand 10 x 100 T	10	T40	100	70	110	86,20
2400891	562157	DuoXpand 10 x 120 T	10	T40	120	70	130	100,50
2400892	562158	DuoXpand 10 x 140 T	10	T40	140	70	150	122,15
2400893	562159	DuoXpand 10 x 160 T	10	T40	160	70	170	158,90
2400894	562152	DuoXpand 8 x 80 FUS	8	10	70	90	90	65,95
2400895	562153	DuoXpand 8 x 100 FUS	8	30	70	110	110	69,70
2400896	562154	DuoXpand 8 x 120 FUS	8	50	70	130	130	80,05
2400897	562167	DuoXpand 10 x 80 FUS	10	10	70	90	90	86,20
2400898	562168	DuoXpand 10 x 100 FUS	10	30	70	110	110	94,05
2400899	562169	DuoXpand 10 x 120 FUS	10	50	70	130	130	108,85
2400900	562170	DuoXpand 10 x 140 FUS	10	70	70	150	150	138,15
2400901	562171	DuoXpand 10 x 160 FUS	10	90	70	170	170	164,05
2400902	562175	DuoXpand 10 x 80 FUS	10	10	70	90	90	415,00
2400903	562176	DuoXpand 10 x 100 FUS	10	30	70	110	110	423,50

Taco largo S-H-R sin tornillo

BASE DE ANCLAJE
HORMIGÓN CELULAR

Ref.	Código	Tipo	Broca Ø mm	Longitud taco mm	Prof. mín. anclaje mm	Prof. mín. taladro mm	€/100
802208	59180	S 14 H 135 R	14	135	45	145	60,65
802212	59187	S 16 H 100 R	16	100	10	110	55,20

Anclaje de alta resistencia FH-S con tornillo de cabeza hexagonal



BASE DE ANCLAJE
HORMIGÓN



Ref.	Código	Tipo	Broca Ø mm	Espesor máx. a fijar mm	Long. del anclaje mm	Prof. mín. anclaje mm	€/100
803033	503133	FH II 10/10 S	10	10	84	50	172,85
803034	503134	FH II 10/25 S	10	25	99	50	215,25
803018	44884	FH II 12/10 S	12	10	95	60	249,70
803019	44885	FH II 12/25 S	12	25	110	60	295,50
803022	44888	FH II 15/25 S	15	25	126	70	204,75
803025	44894	FH II 18/25 S	18	25	138	80	242,80
803027	44898	FH II 24/25 S	24	25	190	125	249,70

Anclaje perno de alto rendimiento FAZ II / INOX



BASE DE ANCLAJE
HORMIGÓN



Ref.	Código	€/100	Ref. INOX	Código INOX	€/100	Tipo	Broca Ø mm en hormigón	Espesor máx. a fijar mm	Par de apriete Nm	Prof. mín. anclaje mm	Profundidad taladro mm
803301	94877	108,45				FAZ II 8/30	8	30	20	45	95
803305	94981	128,15				FAZ II 10/10	10	10	45	60	90
			803456	501406	461,50	FAZ II 10/20	10	20	45	60	100
			803470	501423	444,40	FAZ II 16/25	16	25	110	85	140

Anclaje perno para altas cargas



Eje y clip cincados.

Ref.	Código	Medida	Broca Ø mm en hormigón	Espesor máx. a fijar mm	€/100
8005268	08050SIWA	08x050	8	50	15,81
8005269	08075SIWA	08x075	8	75	16,54
8005270	08090SIWA	08x090	8	90	18,40
8005271	10070SIWA	10x070	10	70	24,54
8005272	10090SIWA	10x090	10	90	26,91
8005273	10120SIWA	10x120	10	120	33,42
8005274	12075SIWA	12x075	12	75	37,09
8005275	12090SIWA	12x090	12	90	39,20
8005276	12110SIWA	12x110	12	110	43,28
8005277	12140SIWA	12x140	12	140	53,52
8005278	12160SIWA	12x160	12	160	62,92
8005279	16125SIWA	16x125	16	125	91,95
8005280	16145SIWA	16x145	16	145	101,62
8005282	20170SIWA	20x170	20	170	189,84



06

Anclaje de alta resistencia FH II-SK con cabeza avellanada



BASE DE ANCLAJE
HORMIGÓN



Ref.	Código	Tipo	Broca Ø mm	Espesor máx. a fijar mm	Long. del anclaje mm	Prof. mín. anclaje mm	€/100
803150	44917	FH II 12/15 SK	12	15	90	60	137,25
803151	44918	FH II 12/25 SK	12	25	100	60	144,25
803152	44919	FH II 12/50 SK	12	50	125	60	158,50
803154	44921	FH II 15/25 SK	15	25	110	70	199,75

Anclaje perno FBN II



BASE DE ANCLAJE
HORMIGÓN



Ref.	Código	Tipo	Broca Ø mm	Espesor máx. a fijar mm	Long. del anclaje mm	Prof. mín. anclaje mm	€/100
803629	40662	FBN II 8/5 [8x66]	8	5/15	66	40/30	51,45
803630	40664	FBN II 8/10 [8x71]	8	10/20	71	40/30	51,25
803631	40669	FBN II 8/20 [8x81]	8	20/30	81	40/30	57,15
803632	40700	FBN II 8/30 [8x91]	8	30/40	91	40/30	59,95
803633	40771	FBN II 8/50 [8x111]	8	50/60	111	40/30	65,35
803635	40783	FBN II 8/100 [8x161]	8	100/110	161	40/30	36,56
803639	40827	FBN II 10/10 [10x86]	10	10/20	86	50/40	74,25
803640	40851	FBN II 10/20 [10x96]	10	20/30	96	50/40	76,05
803641	40854	FBN II 10/30 [10x106]	10	30/40	106	50/40	76,70
803642	40855	FBN II 10/50 [10x126]	10	50/60	126	50/40	37,06
803643	40931	FBN II 10/70 [10x146]	10	70/80	146	50/40	43,10
803644	40943	FBN II 10/100 [10x176]	10	100/110	176	50/40	45,48
803645	40944	FBN II 10/140 [10x216]	10	140/150	216	50/40	61,34
803646	40945	FBN II 10/160 [10x236]	10	160/170	236	50/40	66,54
803647	40946	FBN II 10/5 K [10x71]	10	-/5	71	-/40	73,35
803650	40950	FBN II 12/10 [12x106]	12	10/25	106	65/50	44,68
803651	44558	FBN II 12/20 [12x116]	12	20/35	116	65/50	49,14
803652	45263	FBN II 12/30 [12x126]	12	30/45	126	65/50	52,70
803653	45264	FBN II 12/50 [12x146]	12	50/65	146	65/50	56,70
803654	45265	FBN II 12/80 [12x176]	12	80/95	176	65/50	70,34
803655	45266	FBN II 12/100 [12x196]	12	100/115	196	65/50	80,80
803656	45267	FBN II 12/120 [12x216]	12	120/135	216	65/50	93,78
803657	45268	FBN II 12/140 [12x236]	12	140/155	236	65/50	102,52
803659	45272	FBN II 12/5 K [12x86]	12	-/5	86	-/50	44,24
803662	45564	FBN II 16/25 [16x145]	16	25/40	145	80/65	42,38
803663	45565	FBN II 16/50 [16x170]	16	50/85	170	80/65	69,30
803665	45567	FBN II 16/100 [16x220]	16	100/115	220	80/65	71,90
803669	45571	FBN II 16/15 K [16x120]	16	-/15	120	-/65	38,25
803671	45573	FBN II 20/30 [20x184]	20	30/55	184	105/80	103,00
803672	45574	FBN II 20/60 [20x214]	20	60/85	214	105/80	126,70

Anclaje metálico estándar FSL-RR: con tornillo hexagonal



BASE DE ANCLAJE
HORMIGÓN



Ref.	Código	Tipo	Broca Ø mm	Long. del anclaje mm	Prof. mín. anclaje mm	Rosca métrica	€/100
803816	45650	FSL M6x45 D8	8	45	55	M6	33,05
803817	45759	FSL M6x60 D8	8	60	70	M6	42,88
803820	45652	FSL M8x60 D10	10	60	70	M8	32,00
803821	45653	FSL M8x80 D10	10	80	90	M8	30,25
803824	45654	FSL M10x70 D12	12	70	80	M10	57,90
803825	45655	FSL M10x100 D12	12	100	110	M10	71,50
803828	45656	FSL M12x80 D16	16	80	95	M12	50,47
803829	45657	FSL M12x100 D16	16	110	125	M12	56,01

Anclaje metálico estándar FSL-EY: con hembrilla cerrada



BASE DE ANCLAJE
HORMIGÓN



Ref.	Código	Tipo	Broca Ø mm	Long. del anclaje mm	Prof. mín. anclaje mm	Rosca métrica	€/100
803850	45766	FSL M6x45 EY D8	8	45	55	M6	63,20
803852	45768	FSL M8x60 EY D10	10	60	70	M8	56,35
803854	45770	FSL M10x70 EY D12	12	70	80	M10	48,69
803856	45772	FSL M12x80 EY D16	16	80	95	M12	88,60

Anclaje metálico



Anclaje tornillo hexagonal

Ref.	Código	Medida	Broca Ø mm en hormigón	Espesor máx. a fijar mm	€/100
8005284	08045SICT	8x45	8	45	12,83
2400911	16080SICT	16x80	16	80	62,74
2400912	16110SICT	16x110	16	110	79,32



Anclaje metálico. Con argolla.



Ref.	Código	Medida	Broca Ø mm en hormigón	Espesor máx. a fijar mm	€/100
8005285	08045SICA	8x45	8	45	19,80
8005286	10060SICA	10x60	10	60	33,48
8005287	12070SICA	12x70	12	70	60,22
8005288	16080SICA	16x80	16	80	105,28



Anclaje metálico. Con gancho.



Ref.	Código	Medida	Broca Ø mm en hormigón	Espesor máx. a fijar mm	€/100
8005289	08045SICG	8x45	8	45	19,20
8005290	10060SICG	10x60	10	60	33,07
8005291	12070SICG	12x70	12	70	60,22



Anclaje metálico estándar FSL. FSL-H. Con gancho



BASE DE ANCLAJE
HORMIGÓN



Ref.	Código	Tipo	Broca Ø mm	Long. del anclaje mm	Prof. mín. anclaje mm	Rosca métrica	€/100
803870	45773	FSL M6x45 H D8	8	45	55	M6	59,70
803872	45775	FSL M8x60 H D10	10	60	70	M8	54,50
803874	45777	FSL M10x70 H D12	12	70	80	M10	60,00

Anclaje de expansión a golpes EA-N



BASE DE ANCLAJE
HORMIGÓN



Ref.	Código	Tipo	Broca Ø mm	Longitud taco mm	Prof. mín. anclaje mm	Prof. mín. taladro mm	Rosca mm	€/100
803906	90159	EA M 6 N	8	25	25	25	M 6	22,39
803907	90160	EA M 8 N	10	30	30	30	M 8	27,67
803908	90161	EA M 10 N	12	40	40	40	M 10	21,63
803909	90162	EA M 12 N	16	50	50	50	M 12	39,90
803910	90163	EA M 16 N	20	65	65	65	M 16	47,70

Casquillo de inyección FIS H N



BASE DE ANCLAJE
MATERIAL HUECO



Ref.	Código	Tipo	Broca Ø mm	Longitud taco mm	Prof. mín. anclaje mm	Prof. mín. taladro mm	Adecuado para	€/100
805100	50470	FIS H 16 x 85 N	16	85	85	95	Ø8/M8	56,68
805101	50472	FIS H 18 x 85 N	18	85	85	95	Ø10/M10 - FIS 18/M8 I	61,48
805102	50474	FIS H 20 x 85 N	20	85	85	95	Ø12/M12 - FIS 20/M10 I	70,02

Casquillo de inyección rígido FIS H K



BASE DE ANCLAJE
MATERIAL HUECO

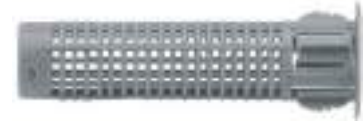

Ref.	Código	Tipo	Broca Ø mm	Longitud taco mm	Prof. mín. anclaje mm	Adecuado para	€/100
805203	41900	FIS H 12x50 K	12	50	60	M6-8	18,27
805204	41901	FIS H 12x85 K	12	85	95	M6-8	20,33
805205	41902	FIS H 16x85 K	16	85	95	M8-10	17,59
805206	41903	FIS H 16x130 K	16	130	140	M8-10	8,22
805207	41904	FIS H 20x85 K	20	85	95	M12-16	8,58

Casquillo metálico a metros FIS M L



BASE DE ANCLAJE
MATERIAL HUECO



Ref.	Código	Tipo	Broca Ø mm	Longitud total mm mm	Adecuado para	€/100
805500	50598	FIS H 12 x 1000 L	12	1.000	M6 - M8	113,30
805501	50599	FIS H 16 x 1000 L	16	1.000	M10 - M12	128,60

Casquillo de inyección FIS E



BASE DE ANCLAJE
MATERIAL HUECO



Ref.	Código	Tipo	Broca Ø mm	Longitud taco mm	Prof. mín. anclaje mm	Adecuado para	€/100
805602	43631	FIS E 11x85 M6	14	85	90	M6	39,96
805603	43632	FIS E 11x85 M8	14	85	90	M8	42,75
805605	43634	FIS E 15x85 M12	18	85	90	M12	60,90

Ampolla de mortero RM



BASE DE ANCLAJE
HORMIGÓN

Ref.	Código	Tipo	Apropiado para	Broca Ø mm	€/100
805700	539796	RM 8	RGM 8	10	32,56
805701	539797	RM 10	RGM 10	12	33,34
805702	539798	RM 12	RGM 12	14	34,27
805704	539800	RM 16	RGM 16	18	48,99
805705	539802	RM 20	RGM 20	25	86,20
805706	539803	RM 24	RGM 24	28	48,70



Varilla roscada RGM con tuerca y arandela en acero y acero inoxidable A4



BASE DE ANCLAJE
HORMIGÓN



Ref.	Código	€/100	Ref. INOX	Código INOX	€/100	Tipo	Apropiado para	Broca Ø mm	Espesor máx. a fijar mm	Profundidad anclaje mm	Profundidad taladro mm
805800	50256	17,70	805900	50263	46,33	RG M 8 x 110	RM 8	10	13	80	80
805801	95698	25,05				RG M 8 x 150	RM 8	10	60	80	80
805802	50257	23,99	805902	50264	71,30	RG M 10 x 130	RM 10	12	20	90	90
805803	50280	28,73				RG M 10 x 165	RM 10	12	57	90	90
805805	50258	34,84	805905	50265	99,20	RG M 12 x 160	RM 12	14	25	110	110
805806	50283	47,10				RG M 12 x 220	RM 12	14	90	110	110
			805907	95702	170,20	RG M 12 x 250	RM 12	14	120	110	110
805809	50259	66,40	805909	50266	210,30	RG M 16 x 190	RM 16	18	35	125	125
805810	50288	81,50	805910	50298	314,20	RG M 16 x 250	RM 16	18	98	125	125
805811	50260	123,10	805911	50267	436,50	RG M 20 x 260*	RM 20	25	65	170	170
805812	50261	218,00				RG M 24 x 300*	RM 24	28	65	210	210

Varilla roscada RG MI, con rosca interna



BASE DE ANCLAJE
HORMIGÓN



Ref.	Código	Tipo	Broca Ø mm	Profundidad atomillado mm	Profundidad anclaje mm	Rosca métrica	€/100
815800	48221	RG 8x75 M5 I	10	8/14	75	M5	35,03
815801	48222	RG 10x75 M6 I	12	10/16	75	M6	40,34

Varilla FIS A



BASE DE ANCLAJE
HORMIGÓN



Ref.	Código	Tipo	Broca Ø mm	Espesor a fijar	Homologado con	Profundidad taladro mm	€/100
806104	90275	FIS A M8x110	10	35/20/5	94404 FIS V 360 S y 17101 FIS V 950 S	65/80/95	19,12
806105	90276	FIS A M8x130	10	55/40/25	94404 FIS V 360 S y 17101 FIS V 950 S	65/80/95	23,86
806108	90279	FIS A M10x130	12	35/25/5	94404 FIS V 360 S y 17101 FIS V 950 S	80/90/110	24,07
806111	90283	FIS A M12x140	14	30/15/5	94404 FIS V 360 S y 17101 FIS V 950 S	95/110/120	30,75
806112	90284	FIS A M12x160	14	50/35/25	94404 FIS V 360 S y 17101 FIS V 950 S	95/110/120	34,09
806117	90289	FIS A M16x200	18	55/40/10	94404 FIS V 360 S y 17101 FIS V 950 S	125/140/170	65,50
806120	90292	FIS A M20x245	24	60/50/10	94404 FIS V 360 S y 17101 FIS V 950 S	160/170/210	119,60
806122	90294	FIS A M24x290	28	65/20/-	94404 FIS V 360 S y 17101 FIS V 950 S	190/240/-	103,05

Acero inoxidable A4 [AISI 316]

Ref. INOX	Código INOX	Tipo	Broca Ø mm	Espesor a fijar	Homologado con	Profundidad atomillado mm	€/100
806208	90447	FIS A M10x130 A4	12	35/25/5	94404 FIS V 360 S y 17101 FIS V 950 S	80/90/110	74,80

Abrazadera M6 cierre de doble tornillo



Ref.	Código	Ø mm	Ø nominal	€/100
807100	15500155	15	1/4"	32,34
807101	15500188	18	3/8"	34,61
807102	15500221	22	1/2"	37,89
807103	15500287	28	3/4"	44,21

Ref.	Código	Ø mm	Ø nominal	€/100
807104	15500350	35	1"	67,17
807105	15500421	42	1 1/4"	69,51
807106	15500500	50	1 1/2"	84,70

Abrazadera M8-M10 cierre de doble tornillo



Ref.	Código	Tipo	Ø mm	Ø nominal	€/100
807200	15520153	M8	15	1/4"	132,73
807201	15520186	M8	18	3/8"	123,89
807202	15520221	M8	22	1/2"	130,03
807203	15520285	M8	28	3/4"	139,68
807204	15520351	M8	35	1"	145,22
807205	15520423	M8	42	1 1/4"	163,26
807206	15520483	M8	48	1 1/2"	174,81
807207	15520542	M8	54	1 3/4"	211,09

Ref.	Código	Tipo	Ø mm	Ø nominal	€/100
807208	15520607	M8+M10	60	2"	161,44
807209	15530754	M8+M10	75	2 1/2"	199,40
807210	15530900	M8+M10	90	3"	220,94
807211	15531102	M8+M10	110	4"	264,00
807212	15531125	M8+M10	125	4 1/4"	309,76
807213	15531405	M8+M10	140	5"	394,06
807214	15531460	M8+M10	160	6"	402,34
807215	15531480	M8+M10	200	6 1/2"	514,79

Abrazadera colgante M10



Ref.	Código	Ø mm	Ø nominal	€/100
807300	15310102	34	1"	192,02
807301	15310142	42	1 1/4"	225,37
807302	15310120	48	1 1/2"	209,60
807303	15310203	60	2"	241,13

Ref.	Código	Ø mm	Ø nominal	€/100
807304	15310212	76	2 2/1"	259,88
807305	15310304	90	3"	340,24
807306	15310405	115	4"	360,56

Abrazadera de dos orejas



Ref.	Código	€/100	Ref. INOX	Código INOX	€/100	Ø d mín.	Ø d máx.
807600	3012101	21,95	807700	23012108	45,90	5	7
807601	3012110	23,22	807701	23012116	52,05	7	9
807602	3012128	23,32	807702	23012124	57,77	9	11
807603	3012099	23,85				10	12
807604	3012136	24,38	807704	23012132	63,71	11	13
807605	3012144	25,76	807705	23012140	74,52	13	15
807606	3012152	31,17	807706	23012159	79,40	14	17
807607	3012160	31,17	807707	23012167	84,80	15	18
807608	3012179	32,44	807708	23012175	90,42	17	20
807609	3012187	35,20	807709	23012183	97,10	18	21

Ref.	Código	€/100	Ref. INOX	Código INOX	€/100	Ø d mín.	Ø d máx.
807610	3012195	40,60	807710	23012191	101,02	20	23
807611	3012208	47,39	807711	23012204	124,02	22	25
807612	3012216	53,32				23	27
807613	3012224	55,12				25	28
807614	3012232	61,70				28	31
807615	3012240	63,87				31	34
807616	3012259	81,62				34	37
807617	3012267	92,75				37	40
807618	3012275	112,47				40	43
807619	3012283	119,47				43	46

Abrazadera alambre

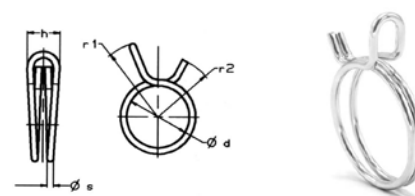

Ref.	Código	Ø d mín.	Ø d máx.	h max mm..	Ø s	r 1 máx.	r 2 máx.	€/100
807800	2016012	7,3	7,8	5,5	1	10,8	8,2	13,44
807801	2016020	7,8	8,3	5,5	1	10,8	8,3	13,89
807802	2016039	8,3	8,8	5,5	1	11	8,6	14,23
807803	2016047	8,8	9,3	5,5	1	11	9	15,24
807804	2016055	9,3	9,9	5,5	1	11,8	9	15,68
807805	2016063	9,8	10,4	6,3	1,2	13,5	10,5	16,36
807806	2016071	10,4	11	6,3	1,2	14,8	11,4	17,25
807807	2016080	11	11,6	6,3	1,5	14,8	11,9	17,81
807808	2016098	11,6	12,3	7,3	1,5	16,4	12,4	18,48
807809	2016100	12,1	13,1	7,3	1,5	17,2	13,7	19,04

Ref.	Código	Ø d mín.	Ø d máx.	h max mm..	Ø s	r 1 máx.	r 2 máx.	€/100
807810	2016119	12,9	13,6	7,3	1,5	17,5	14	19,60
807811	2016127	13,6	14,4	7,3	1,5	18	14,5	20,16
807812	2016135	14,4	15,1	8,4	1,5	19,6	16	21,84
807813	2016143	14,8	15,9	8,4	1,8	21	16,4	22,96
807814	2016151	15,9	16,8	8,4	1,8	22	16,6	23,86
807815	2016160	16,8	17,7	8,4	1,8	21,3	16,5	24,87
807816	2016178	17,7	18,7	9,9	2	22,7	17,7	26,88
807817	2016186	18,7	19,6	9,9	2	23,3	18	28,00
807818	2016194	19,6	20,6	9,9	2	24	18,5	29,12

Abrazadera muelle

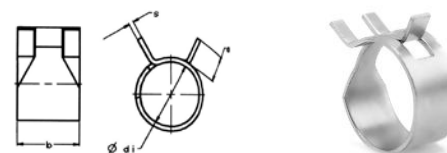

Ref.	Código	Ø d nom.	Ø di	b	a ± 0,5	s	Ø da mín.	Ø da máx.	€/100
807900	2014025	6	5,5 ± 0,1	7	3	0,5	5,9	6,1	20,72
807901	2014033	7	6,4 ± 0,1	7	3	0,5	6,9	7,1	18,60
807902	2014041	8	7,4 ± 0,15	8	3	0,6	7,9	8,2	18,71
807903	2014050	9	8,4 ± 0,15	8	3,5	0,6	8,9	9,3	20,39
807904	2014068	10	9,3 ± 0,2	8	3,5	0,7	9,9	10,4	20,50
807905	2014076	11	10,3 ± 0,2	8	4	0,7	10,9	11,5	23,64

Ref.	Código	Ø d nom.	Ø di	b	a ± 0,5	s	Ø da mín.	Ø da máx.	€/100
807906	2014084	12	11,1 ± 0,2	8	4	0,7	11,9	12,6	24,08
807907	2014092	14	12,9 ± 0,2	8	4	0,8	13,8	14,6	27,89
807908	2014105	15	13,5 ± 0,2	8	4,5	0,8	14,8	15,8	29,57
807909	2014113	17	15,6 ± 0,2	8	4,5	0,8	16,8	18	31,48
807910	2014121	20	18,4 ± 0,4	8	3,2	0,8	20	21,3	37,19

Abrazadera clip inoxidable W4



Ref. INOX	Código INOX	Color	Ø Aplicación	€/100
818600	3030410	Amarillo	8,5-9,5	51,90
818601	3030429	Violeta	9,5-10,5	54,04
818602	3030437	Neutro	10,5-11,5	56,18
818603	3030445	Verde	11,5-12,5	57,78
818604	3030453	Negro	12,5-14	60,99
818606	3030461	Amarillo	13,5-15	62,06
818607	3030470	Violeta	14,5-16	62,49
818608	3030488	Neutro	15,5-17	63,13
818609	3030496	Verde	16,5-18	63,88

Ref. INOX	Código INOX	Color	Ø Aplicación	€/100
818610	3030509	Negro	17,5-19	64,42
818611	3030517	Amarillo	18,5-20	65,27
818612	3030525	Violeta	19,5-21	65,92
818613	3030533	Neutro	20,5-22	66,88
818614	3030541	Verde	21,5-23	68,27
818615	3030550	Negro	22,5-24	69,02
818616	3030568	Amarillo	23,5-25	70,62
818617	3030576	Violeta	24,5-26	71,69

Abrazadera normal W1

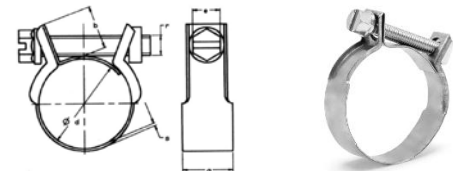

Ref.	Código	Ø d Aplicación	r	e	a	b	s	Ø da Par Nm	Ø da Press. Bar	€/100
808000	3010510	6	M3	-	8,4	9	0,5	0,4	15	31,59
808001	3010528	8	M3	-	9	9	0,5	0,4	14	32,82
808002	3010536	9	M4	6	10	10	0,5	1	15	36,96
808003	3010544	9,5-10	M4	6	10	10	0,5	1	14	37,08
808004	3010552	44510	M4	6	10	10	0,5	1	130	37,64
808005	3010560	41609	M4	6	10	10	0,5	1	12,5	37,75
808006	3010579	13-14	M4	6	10	10	0,5	1	12,5	37,97
808007	3010587	14-15	M4	6	10	10	0,5	1	12	39,09
808008	3010595	15-17	M4	6	10	10	0,5	1	12	39,65

Ref.	Código	Ø d Aplicación	r	e	a	b	s	Ø da Par Nm	Ø da Press. Bar	€/100
808009	3010608	16-18	M4	6	10	10	0,5	1	11,5	40,10
808010	3010616	18-20	M4	6	10	10	0,5	1	10,5	40,66
808011	3010624	19-21	M4	6	10	10	0,5	1	10,5	41,11
808012	3010632	20-22	M4	6	10	10	0,5	1	10,5	41,67
808013	3010640	22-25	M4	6	10	10	0,5	1	9,5	42,12
808014	3010659	23-26	M4	6	10	10	0,5	1	9	43,01
808015	3010667	25-28	M4	6	10	10	0,5	1	8,5	44,47
808016	3010675	26-29	M4	6	10	10	0,5	1	8,5	45,92
808017	3010683	29-32	M4	6	10	10	0,5	1	8	48,72

Abrazadera ASFA-L [7 mm] W1



Material: Cinta y cabezal de acero W1 (DIN 1.0935). Tornillo de acero Qst 36-3 (DIN 1.0213)

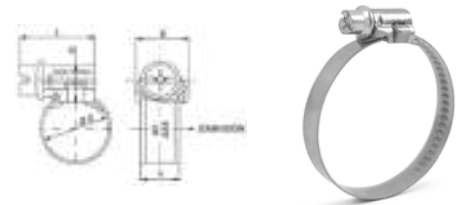

Ref.	Código	Ø d Aplicación	L +1 -0.5	H Máx.	B Máx.	A ±0.3	Ø da Par Nm	Ø da Press. Bar	€/100
2400913	3008745	8-12	18.5	9.2	11.5	7	1.5	15	26,94
2400914	3008746	10-16	18.5	9.2	11.5	7	1.5	15	27,04
2400915	3008747	12-22	18.5	9.2	11.5	7	1.5	15	30,16

Ref.	Código	Ø d Aplicación	L +1 -0.5	H Máx.	B Máx.	A ±0.3	Ø da Par Nm	Ø da Press. Bar	€/100
2400916	3008748	16-27	18.5	9.2	11.5	7	1.5	15	30,68
2400917	3008749	20-32	18.5	9.2	11.5	7	1.5	15	31,72
	3008750	25-40	18.5	9.2	11.5	7	1.5	15	

Abrazadera ASFA-L (7 mm) inoxidable W2

MIKALOR

Material: Cinta y cabezal de acero inoxidable X6Cr17 W2 AISI 430 (DIN 1.4016).
Tornillo de acero Qst 36-3(DIN 1.0213).

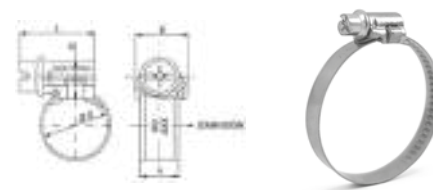

Ref. INOX	Código INOX	Ø d Aplicación	L +1 -0.5	H Máx.	B Máx.	A ±0.3	Ø da Par Nm	Ø da Press. Bar	€/100
2400919	3016508	8-12	18.5	9.2	11.5	7	15	1.5	36,20
2400920	3016509	10-16	18.5	9.2	11.5	7	15	1.5	36,40
2400921	3016510	12-22	18.5	9.2	11.5	7	15	1.5	39,52

Ref. INOX	Código INOX	Ø d Aplicación	L +1 -0.5	H Máx.	B Máx.	A ±0.3	Ø da Par Nm	Ø da Press. Bar	€/100
2400922	3016511	16-27	18.5	9.2	11.5	7	15	1.5	41,08
2400923	3016512	20-32	18.5	9.2	11.5	7	15	1.5	43,68
2400924	3016513	25-40	18.5	9.2	11.5	7	15	1.5	47,84

Abrazadera ASFA High Torque inoxidable W3

MIKALOR

Material: Cinta y cabezal acero inox. W3 AISI 430 X6Cr17 (DIN 1.4016) Tornillo de acero inoxidable W4 AISI 304 Cu

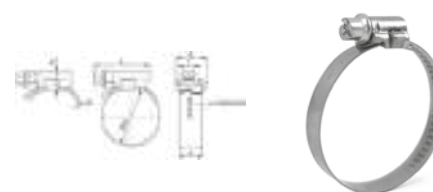

Ref. INOX	Código INOX	Ø d Aplicación	L Máx.	S ±0.1	H Máx.	B Máx.	Valores máx. (*) Par Nm	Valores máx. (*) Press. Bar	€/100
2400925	3066001	25-45	40	0.85	14	22	14	55	265,00
2400926	3066002	32-54	40	0.85	14	22	14	50	268,18
2400927	3066003	45-67	40	0.85	14	22	14	45	283,02
2400928	3066004	57-79	40	0.85	14	22	14	40	295,74
2400929	3066005	70-92	40	0.85	14	22	14	30	309,52
2400930	3066006	83-105	40	0.85	14	22	14	20	324,36
2400931	3066007	95-118	40	0.85	14	22	14	17	338,14
2400932	3066008	108-130	40	0.85	14	22	14	14	351,92

Ref. INOX	Código INOX	Ø d Aplicación	L Máx.	S ±0.1	H Máx.	B Máx.	Valores máx. (*) Par Nm	Valores máx. (*) Press. Bar	€/100
2400933	3066009	121-143	40	0.85	14	22	14	11	365,70
2400934	3066010	133-156	40	0.85	14	22	14	8	379,48
2400935	3066011	146-168	40	0.85	14	22	14	6	393,26
2400936	3066012	159-181	40	0.85	14	22	14	5	407,04
2400937	3066013	172-194	40	0.85	14	22	14	4	421,88
2400938	3066014	184-206	40	0.85	14	22	14	3	434,60
2400939	3066015	197-219	40	0.85	14	22	14	2	445,20
2400940	3066016	210-232	40	0.85	14	22	14	2	455,80

Abrazadera sin/fin L W1 serie ligera

MIKALOR

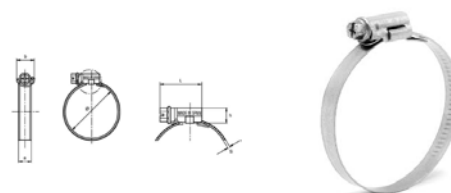

Ref.	Código	b máx.	h máx. mm.	L máx.	Ø d Aplicación	+0.1 s 0	+0.3 a -0.2	Valores máx. (*) Par Nm	Valores máx. (*) Press. Bar	€/100
818700	3008745	11.5	8.4	17.5	8-12	0.6	7	1.5	40	26,94
818701	3008753	14	10	22.1	8-16	0.6	9	3	45	43,16
818702	3008761	14	10	22.1	12-22	0.6	9	3	45	44,20
818703	3008770	14	10	23.6	16-27	0.7	9	3.5	42	47,32
818704	3008788	14	10	23.6	20-32	0.7	9	3.5	36	51,48
818706	3008796	14	10	25.6	25-40	0.7	9	4	32	55,64
818707	3008809	14	10	25.6	30-45	0.7	9	4	28	59,28
818708	3008817	14	10	25.6	32-50	0.7	9	4	24	61,36
818709	3008825	14	10	25.6	40-60	0.7	9	4	19	68,64
818710	3008833	14	10	29.6	50-70	0.7	9	4	17	88,40

Ref.	Código	b máx.	h máx. mm.	L máx.	Ø d Aplicación	+0.1 s 0	+0.3 a -0.2	Valores máx. (*) Par Nm	Valores máx. (*) Press. Bar	€/100
818711	3008841	14	10	29.6	60-80	0.7	9	4	15	94,64
818712	3008850	14	10	29.6	70-90	0.7	9	4	13	98,80
818713	3008868	14	10	29.6	80-100	0.7	9	4	11	106,08
818714	3008876	14	10	29.6	90-110	0.7	9	4	10	140,40
818715	3008884	14	10	29.6	100-120	0.7	9	4	9	160,16
818716	3008892	14	10	29.6	110-130	0.7	9	4	8	175,76
818717	3008905	14	10	29.6	120-140	0.7	9	4	7	193,44
818718	3008913	14	10	29.6	130-150	0.7	9	4	6	214,24
818719	3008921	14	10	29.6	140-160	0.7	9	4	5	230,88

Abrazadera sin/fin L INOX W2 serie ligera

MIKALOR

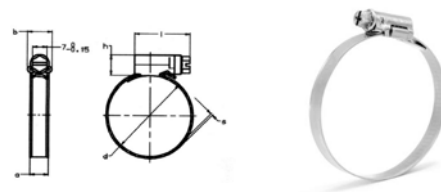

Ref. INOX	Código INOX	Ø d Aplicación	+0,1 s 0	l máx.	h máx. mm.	+0,3 a -0,2	b máx. a -0,2	Valores máx. (*) Par Nm	Valores máx. (*) Press. Bar	€/100
808300	3016508	8-12	0,6	18	9,5	7,5	11,5	1,5	40	36,20
808301	3016516	8-16	0,6	22,1	10	9	14	3	45	44,72
808302	3016524	12-22	0,6	23,6	10	9	14	3	45	45,76
808303	3016532	16-27	0,7	23,6	10	9	14	3,5	42	48,88
808304	3016540	20-32	0,7	23,6	10	9	14	3,5	36	53,04
808306	3016559	25-40	0,7	25,6	10	9	14	4	32	58,24
808307	3016567	30-45	0,7	25,6	10	9	14	4	28	61,36
808308	3016575	32-50	0,7	25,6	10	9	14	4	24	64,48
808309	3016583	40-60	0,7	25,6	10	9	14	4	19	72,80
808310	3016591	50-70	0,7	26,6	10	9	14	4	17	91,52

Ref. INOX	Código INOX	Ø d Aplicación	+0,1 s 0	l máx.	h máx. mm.	+0,3 a -0,2	b máx. a -0,2	Valores máx. (*) Par Nm	Valores máx. (*) Press. Bar	€/100
808311	3016604	60-80	0,7	26,6	10	9	14	4	15	98,80
808312	3016612	70-90	0,7	26,6	10	9	14	4	13	104,00
808313	3016620	80-100	0,7	26,6	10	9	14	4	11	111,28
808314	3016639	90-110	0,7	26,6	10	9	14	4	10	147,68
808315	3016647	100-120	0,7	26,6	10	9	14	4	9	167,86
808316	3016655	110-130	0,7	26,6	10	9	14	4	8	183,98
808317	3016663	120-140	0,7	26,6	10	9	14	4	7	203,43
808318	3016671	130-150	0,7	26,6	10	9	14	4	6	225,06
808319	3016680	140-160	0,7	26,6	10	9	14	4	5	242,32

Abrazadera sin/fin L INOX W3 serie ligera

MIKALOR

DIN 3017

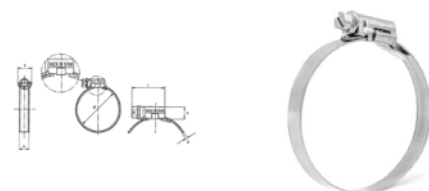

Ref. INOX	Código INOX	b máx.	h máx. mm.	L máx.	Ø d Aplicación	+0,1 s 0	+0,3 a -0,2	Valores máx. (*) Par Nm	Valores máx. (*) Press. Bar	€/100
816100	3016014	14	10	22,1	8-16	0,6	9	3	45	69,43
816101	3016022	14	10	22,1	12-22	0,6	9	3	45	74,20
816102	3016030	14	10	23,6	16-27	0,7	9	3,5	42	78,44
816103	3016049	14	10	23,6	20-32	0,7	9	3,5	36	79,50
816104	3016065	14	10	25,6	25-40	0,7	9	4	32	90,10
816105	3016073	14	10	25,6	30-45	0,7	9	4	28	93,81
816106	3016081	14	10	25,6	32-50	0,7	9	4	24	98,58
816107	3016090	14	10	25,6	40-60	0,7	9	4	19	108,12
816108	3016102	14	10	29,6	50-70	0,7	9	4	17	124,02

Ref. INOX	Código INOX	b máx.	h máx. mm.	L máx.	Ø d Aplicación	+0,1 s 0	+0,3 a -0,2	Valores máx. (*) Par Nm	Valores máx. (*) Press. Bar	€/100
816109	3016110	14	10	29,6	60-80	0,7	9	4	15	132,50
816110	3016129	14	10	29,6	70-90	0,7	9	4	13	138,86
816111	3016137	14	10	29,6	80-100	0,7	9	4	11	145,22
816112	3016145	14	10	29,6	90-110	0,7	9	4	10	167,48
816113	3016153	14	10	29,6	100-120	0,7	9	4	9	201,09
816114	3016161	14	10	29,6	110-130	0,7	9	4	8	221,65
816115	3016170	14	10	29,6	120-140	0,7	9	4	7	250,16
816116	3016188	14	10	29,6	130-150	0,7	9	4	6	277,41
816117	3016196	14	10	29,6	140-160	0,7	9	4	5	297,86

Abrazadera ASFA-L INOX W4 serie ligera

MIKALOR

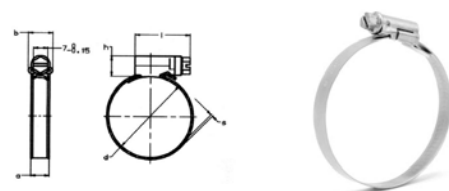

Ref. INOX	Código INOX	Ø d Aplicación	S ±0,05	l máx.	h máx. mm.	+0,3 a -0,2	b máx.	Valores máx. (*) Par Nm	Valores máx. (*) Press. Bar	€/100
808419	3014000	8-12	0,6	17,5	8,4	7	11,5	1,5	40	157,50
808400	3014019	8-16	0,6	22,1	10	9	14	3	45	137,03
808401	3014027	12-22	0,6	22,1	10	9	14	3	45	149,00
808402	3014035	16-27	0,7	23,6	10	9	14	3,5	42	154,98
808403	3014043	20-32	0,7	23,6	10	9	14	3,5	36	161,70
808405	3014051	25-40	0,7	25,6	10	9	14	4	32	178,50
808406	3014060	30-45	0,7	25,6	10	9	14	4	28	193,94
808407	3014078	32-50	0,7	25,6	10	9	14	4	24	207,27
808408	3014086	40-60	0,7	25,6	10	9	14	4	19	212,10
808409	3014094	50-70	0,7	29,6	10	9	14	4	17	220,50

Ref. INOX	Código INOX	Ø d Aplicación	S ±0,05	l máx.	h máx. mm.	+0,3 a -0,2	b máx.	Valores máx. (*) Par Nm	Valores máx. (*) Press. Bar	€/100
808410	3014107	60-80	0,7	29,6	10	9	14	4	15	225,75
808411	3014115	70-90	0,7	29,6	10	9	14	4	13	241,50
808412	3014123	80-100	0,7	29,6	10	9	14	4	11	266,70
808413	3014140	90-110	0,7	29,6	10	9	14	4	10	313,95
808414	3014158	100-120	0,7	29,6	10	9	14	4	9	337,05
808415	3014166	110-130	0,7	29,6	10	9	14	4	8	399,00
808416	3014174	120-140	0,7	29,6	10	9	14	4	7	428,40
808417	3014182	130-150	0,7	29,6	10	9	14	4	6	451,50
808418	3014190	140-160	0,7	29,6	10	9	14	4	5	484,05

06

Abrazadera sin/fin L INOX W5 serie ligera



DIN 3017

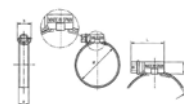

Ref. INOX	Código INOX	Ø d Aplicación	S ±0,05	l máx	h máx mm.	+0,3 a -0,2	b máx.	Valores máx.(*) Par Nm	Valores máx.(*) Press. Bar	€/100
816200	3015759	8-16	0,6	22,1	10	9	14	3	45	186,17
816201	3015767	12-22	0,6	22,1	10	9	14	3	45	192,15
816202	3015775	16-27	0,7	23,6	10	9	14	3,5	42	204,12
816203	3015783	20-32	0,7	23,6	10	9	14	3,5	36	211,26
816204	3015804	25-40	0,7	25,6	10	9	14	4	32	233,42
816205	3015812	30-45	0,7	25,6	10	9	14	4	28	240,45
816206	3015820	32-50	0,7	25,6	10	9	14	4	24	263,55
816207	3015839	40-60	0,7	25,6	10	9	14	4	19	279,30
816208	3015847	50-70	0,7	29,6	10	9	14	4	17	311,85

Ref. INOX	Código INOX	Ø d Aplicación	S ±0,05	l máx	h máx mm.	+0,3 a -0,2	b máx.	Valores máx.(*) Par Nm	Valores máx.(*) Press. Bar	€/100
816209	3015855	60-80	0,7	29,6	10	9	14	4	15	353,85
816210	3015863	70-90	0,7	29,6	10	9	14	4	13	368,55
816211	3015871	80-100	0,7	29,6	10	9	14	4	11	406,35
816212	3015880	90-110	0,7	29,6	10	9	14	4	10	434,70
816213	3015898	100-120	0,7	29,6	10	9	14	4	9	464,10
816214	3015900	110-130	0,7	29,6	10	9	14	4	8	498,75
816215	3015919	120-140	0,7	29,6	10	9	14	4	7	537,60
816216	3015927	130-150	0,7	29,6	10	9	14	4	6	574,35
816217	3015935	140-160	0,7	29,6	10	9	14	4	5	605,85

Abrazadera ASFA-S W1 serie pesada



DIN 3017

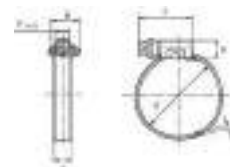

Ref.	Código	b máx.	h máx mm.	L máx.	Ø d Aplicación	+0,1 s 0	+0,4 a -0,2	Valores máx.(*) Par Nm	Valores máx.(*) Press. Bar	€/100
808100	3009001	18	11	29,6	16-27	0,8	12,2	4,2	45	73,84
808101	3009002	18	11	29,6	20-32	0,8	12,2	5,2	45	74,88
808102	3009003	18	11	29,6	25-40	0,8	12,2	5,2	40	78,00
808103	3009004	18	11	29,6	30-45	0,8	12,2	5,2	35	83,20
808104	3009005	18	11	29,6	32-50	0,8	12,2	6	35	85,28
808105	3009006	18	11	29,6	40-60	0,8	12,2	6	30	90,48
808106	3009007	18	11	31,6	50-70	0,8	12,2	6,8	25	98,80
808107	3009008	18	11	31,6	60-80	0,8	12,2	6,8	20	119,60
808108	3009009	18	11	31,6	70-90	0,8	12,2	6,8	17	128,96
808109	3009010	18	11	31,6	80-100	0,8	12,2	6,8	14	135,20
808110	3009011	18	11	31,6	90-110	0,8	12,2	6,8	12	165,36
808111	3009012	18	11	31,6	100-120	0,8	12,2	6,8	10	170,56

Ref.	Código	b máx.	h máx mm.	L máx.	Ø d Aplicación	+0,1 s 0	+0,4 a -0,2	Valores máx.(*) Par Nm	Valores máx.(*) Press. Bar	€/100
808112	3009013	18	11	31,6	110-130	0,8	12,2	6,8	8	188,24
808113	3009014	18	11	34,6	120-140	0,8	12,2	6,8	7	210,08
808114	3009015	18	11	34,6	130-150	0,8	12,2	6,8	6	229,84
808115	3009016	18	11	34,6	140-160	0,8	12,2	6,8	5	244,40
808116	3009017	18	11	34,6	150-170	0,8	12,2	6,8	4	256,88
808117	3009018	18	11	34,6	160-180	0,8	12,2	6,8	3	262,08
808118	3009019	18	11	34,6	170-190	0,8	12,2	6,8	2	270,40
808119	3009020	18	11	34,6	180-200	0,8	12,2	6,8	2	294,32
808120	3009021	18	11	34,6	190-210	0,8	12,2	6,8	1,8	308,88
808121	3009022	18	11	34,6	200-220	0,8	12,2	6,8	1,8	328,64
808122	3009023	18	11	34,6	210-230	0,8	12,2	6,8	1,6	346,32
808123	3009024	18	11	34,6	220-240	0,8	12,2	6,8	1,6	358,80

Abrazadera sin/fin S INOX W2 serie pesada

MIKALOR

DIN 3017

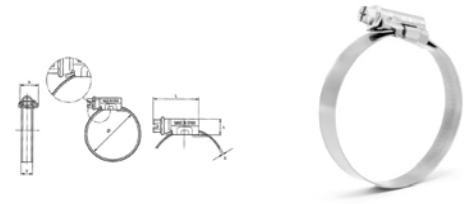

Ref. INOX	Código INOX	b máx.	h	Longitud mm	Ø d Aplicación	s +10	+0,4 a -0,2	Valores máx. (*) Par Nm	Valores máx. (*) Press. Bar	€/100
816300	3017017	18	11	29,6	16-27	0,8	12,2	4,2	45	113,36
816301	3017025	18	11	29,6	20-32	0,8	12,2	5,2	45	123,76
816302	3017033	18	11	29,6	25-40	0,8	12,2	5,2	40	128,96
816303	3017009	18	11	29,6	30-45	0,8	12,2	5,2	35	131,04
816304	3017041	18	11	29,6	32-50	0,8	12,2	6	35	135,20
816305	3017050	18	11	29,6	40-60	0,8	12,2	6	30	148,72
816306	3017068	18	11	31,6	50-70	0,8	12,2	6,8	25	166,40
816307	3017076	18	11	31,6	60-80	0,8	12,2	6,8	20	182,00
816308	3017084	18	11	31,6	70-90	0,8	12,2	6,8	17	199,68
816309	3017092	18	11	31,6	80-100	0,8	12,2	6,8	14	205,92
816310	3017105	18	11	31,6	90-110	0,8	12,2	6,8	12	222,56
816311	3017113	18	11	31,6	100-120	0,8	12,2	6,8	10	226,72

Ref. INOX	Código INOX	b máx.	h	Longitud mm	Ø d Aplicación	s +10	+0,4 a -0,2	Valores máx. (*) Par Nm	Valores máx. (*) Press. Bar	€/100
816312	3017121	18	11	31,6	110-130	0,8	12,2	6,8	8	244,40
816313	3017130	18	11	34,6	120-140	0,8	12,2	6,8	7	260,00
816314	3017148	18	11	34,6	130-150	0,8	12,2	6,8	6	267,28
816315	3017156	18	11	34,6	140-160	0,8	12,2	6,8	5	277,68
816316	3017164	18	11	34,6	150-170	0,8	12,2	6,8	4	323,44
816317	3017172	18	11	34,6	160-180	0,8	12,2	6,8	3	341,12
816318	3017180	18	11	34,6	170-190	0,8	12,2	6,8	2	371,28
816319	3017199	18	11	34,6	180-200	0,8	12,2	6,8	2	384,80
816320	3017201	18	11	34,6	190-210	0,8	12,2	6,8	1,8	400,40
816321	3017210	18	11	34,6	200-220	0,8	12,2	6,8	1,8	413,92
816322	3017228	18	11	34,6	210-230	0,8	12,2	6,8	1,6	436,80
816323	3017236	18	11	34,6	220-240	0,8	12,2	6,8	1,6	462,80

Abrazadera sin/fin S INOX W3 serie pesada

MIKALOR

DIN 3017

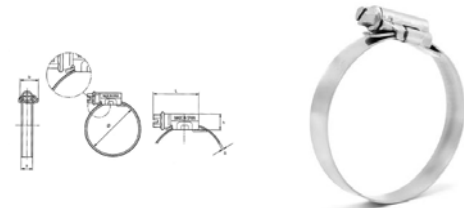

Ref. INOX	Código INOX	b máx.	h	Longitud mm	Ø d Aplicación	s +10	+0,4 a -0,2	Valores máx. (*) Par Nm	Valores máx. (*) Press. Bar	€/100
816400	3016209	18	11	29,6	16-27	0,8	12,2	4,2	45	169,60
816401	3016217	18	11	29,6	20-32	0,8	12,2	5,2	45	178,08
816402	3016225	18	11	29,6	25-40	0,8	12,2	5,2	40	184,44
816403	3016233	18	11	29,6	30-45	0,8	12,2	5,2	35	187,62
816404	3016241	18	11	29,6	32-50	0,8	12,2	6	35	191,86
816405	3016250	18	11	29,6	40-60	0,8	12,2	6	30	214,12
816406	3016268	18	11	31,6	50-70	0,8	12,2	6,8	25	239,56
816407	3016276	18	11	31,6	60-80	0,8	12,2	6,8	20	262,88
816408	3016284	18	11	31,6	70-90	0,8	12,2	6,8	17	288,32
816409	3016292	18	11	31,6	80-100	0,8	12,2	6,8	14	297,86
816410	3016305	18	11	31,6	90-110	0,8	12,2	6,8	12	321,18
816411	3016313	18	11	31,6	100-120	0,8	12,2	6,8	10	325,42

Ref. INOX	Código INOX	b máx.	h	Longitud mm	Ø d Aplicación	s +10	+0,4 a -0,2	Valores máx. (*) Par Nm	Valores máx. (*) Press. Bar	€/100
816412	3016321	18	11	31,6	110-130	0,8	12,2	6,8	8	354,04
816413	3016330	18	11	34,6	120-140	0,8	12,2	6,8	7	373,12
816414	3016348	18	11	34,6	130-150	0,8	12,2	6,8	6	386,90
816415	3016356	18	11	34,6	140-160	0,8	12,2	6,8	5	402,80
816416	3016364	18	11	34,6	150-170	0,8	12,2	6,8	4	469,58
816417	3016372	18	11	34,6	160-180	0,8	12,2	6,8	3	495,02
816418	3016380	18	11	34,6	170-190	0,8	12,2	6,8	2	539,54
816419	3016399	18	11	34,6	180-200	0,8	12,2	6,8	2	558,62
816420	3016428	18	11	34,6	190-210	0,8	12,2	6,8	1,8	581,94
816421	3016436	18	11	34,6	200-220	0,8	12,2	6,8	1,8	601,02
816422	3016444	18	11	34,6	210-230	0,8	12,2	6,8	1,6	633,88
816423	3016452	18	11	34,6	220-240	0,8	12,2	6,8	1,6	669,92

Abrazadera ASFA-S INOX W4 serie pesada

MIKALOR

DIN 3017

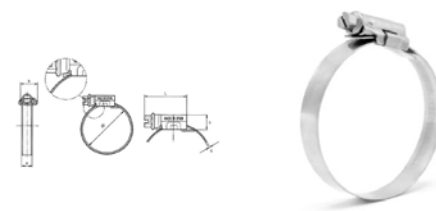

Ref. INOX	Código INOX	Ø d Aplicación	s ±0,05	l máx.	h máx. mm.	+0,4 a -0,2	b máx.	Valores máx. (*) Par Nm	Valores máx. (*) Press. Bar	€/100
808200	3014730	16-27	0,8	29,6	11	12,2	18	4,6	45	228,90
808201	3014510	20-32	0,8	29,6	11	12,2	18	5,6	45	237,30
808202	3014529	25-40	0,8	29,6	11	12,2	18	5,6	40	256,20
808203	3014748	30-45	0,8	29,6	11	12,2	18	5,6	35	266,70
808204	3014537	32-50	0,8	29,6	11	12,2	18	6,5	35	270,90
808205	3014545	40-60	0,8	29,6	11	12,2	18	6,5	30	288,75
808206	3014553	50-70	0,8	31,6	11	12,2	18	7	25	318,15
808207	3014561	60-80	0,8	31,6	11	12,2	18	7	20	351,75
808208	3014570	70-90	0,8	31,6	11	12,2	18	7	17	367,50
808209	3014588	80-100	0,8	31,6	11	12,2	18	7	14	383,25
808210	3014596	90-110	0,8	31,6	11	12,2	18	7	12	393,75
808211	3014609	100-120	0,8	31,6	11	12,2	18	7	10	425,25

Ref. INOX	Código INOX	Ø d Aplicación	s ±0,05	l máx.	h máx. mm.	+0,4 a -0,2	b máx.	Valores máx. (*) Par Nm	Valores máx. (*) Press. Bar	€/100
808212	3014617	110-130	0,8	31,6	11	12,2	18	7	8	428,40
808213	3014625	120-140	0,8	34,6	11	12,2	18	7	7	437,85
808214	3014633	130-150	0,8	34,6	11	12,2	18	7	6	455,70
808215	3014641	140-160	0,8	34,6	11	12,2	18	7	5	487,20
808216	3014650	150-170	0,8	34,6	11	12,2	18	7	4	515,55
808217	3014668	160-180	0,8	34,6	11	12,2	18	7	3	553,35
808218	3014676	170-190	0,8	34,6	11	12,2	18	7	2	579,60
808219	3014684	180-200	0,8	34,6	11	12,2	18	7	2	612,15
808220	3014692	190-210	0,8	34,6	11	12,2	18	7	1,8	636,30
808221	3014705	200-220	0,8	34,6	11	12,2	18	7	1,8	666,75
808222	3014713	210-230	0,8	34,6	11	12,2	18	7	1,6	693,00
808223	3014721	220-240	0,8	34,6	11	12,2	18	7	1,6	724,50

Abrazadera sin/fin S INOX W5 serie pesada

MIKALOR

DIN 3017



Ref. INOX	Código INOX	b máx.	h	L máx.	Ø d Aplicación	s ± 5	+0,4 a -0,2	Valores máx. (*) Par Nm	Valores máx. (*) Press. Bar	€/100
816500	3017720	18	11	29,6	16-27	0,8	12,2	4,6	45	336,00
816501	3017500	18	11	29,6	20-32	0,8	12,2	5,6	45	351,75
816502	3017519	18	11	29,6	25-40	0,8	12,2	5,6	40	367,50
816503	3017738	18	11	29,6	30-45	0,8	12,2	5,6	35	378,00
816504	3017527	18	11	29,6	32-50	0,8	12,2	6,5	35	388,50
816505	3017535	18	11	29,6	40-60	0,8	12,2	6,5	30	472,50
816506	3017543	18	11	31,6	50-70	0,8	12,2	7	25	493,50
816507	3017551	18	11	31,6	60-80	0,8	12,2	7	20	525,00
816508	3017560	18	11	31,6	70-90	0,8	12,2	7	17	551,25
816509	3017578	18	11	31,6	80-100	0,8	12,2	7	14	577,50
816510	3017586	18	11	31,6	90-110	0,8	12,2	7	12	603,75
816511	3017594	18	11	31,6	100-120	0,8	12,2	7	10	640,50

Ref. INOX	Código INOX	b máx.	h	L máx.	Ø d Aplicación	s ± 5	+0,4 a -0,2	Valores máx. (*) Par Nm	Valores máx. (*) Press. Bar	€/100
816512	3017607	18	11	31,6	110-130	0,8	12,2	7	8	709,80
816513	3017615	18	11	34,6	120-140	0,8	12,2	7	7	746,55
816514	3017623	18	11	34,6	130-150	0,8	12,2	7	6	777,00
816515	3017631	18	11	34,6	140-160	0,8	12,2	7	5	802,20
816516	3017640	18	11	34,6	150-170	0,8	12,2	7	4	898,80
816517	3017658	18	11	34,6	160-180	0,8	12,2	7	3	931,35
816518	3017666	18	11	34,6	170-190	0,8	12,2	7	2	961,80
816519	3017674	18	11	34,6	180-200	0,8	12,2	7	2	1.008,00
816520	3017682	18	11	34,6	190-210	0,8	12,2	7	1,8	1.123,50
816521	3017690	18	11	34,6	200-220	0,8	12,2	7	1,8	1.141,35
816522	3017703	18	11	34,6	210-230	0,8	12,2	7	1,6	1.182,30
816523	3017711	18	11	34,6	220-240	0,8	12,2	7	1,6	1.214,85

Abrazadera ASFA High Torque inoxidable W4

MIKALOR

Material: Cinta y cabezal acero inox. W4 AISI 304 X5Cr Ni 18/10 (DIN 1.4301).
Tornillo de acero inoxidable W4 AISI 30



Ref. INOX	Código INOX	ØD Aplicación	a ±0.2	L Máx.	S ±0.1	H Máx.	B Máx.	Valores máx. (*) Par Nm	Valores máx. (*) Press. Bar	€/100
2400941	3067001	25-45	16	40	0.8	14	22	14	55	390,60
2400942	3067002	32-54	16	40	0.8	14	22	14	50	396,90
2400943	3067003	45-67	16	40	0.8	14	22	14	45	404,25
2400944	3067004	57-79	16	40	0.8	14	22	14	40	417,90
2400945	3067005	70-92	16	40	0.8	14	22	14	30	424,20
2400946	3067006	83-105	16	40	0.8	14	22	14	20	437,85
2400947	3067007	95-118	16	40	0.8	14	22	14	17	448,35
2400948	3067008	108-130	16	40	0.8	14	22	14	14	464,10

Ref. INOX	Código INOX	ØD Aplicación	a ±0.2	L Máx.	S ±0.1	H Máx.	B Máx.	Valores máx. (*) Par Nm	Valores máx. (*) Press. Bar	€/100
2400949	3067009	121-143	16	40	0.8	14	22	14	11	494,55
2400950	3067010	133-156	16	40	0.8	14	22	14	8	507,15
2400951	3067011	146-168	16	40	0.8	14	22	14	6	512,40
2400952	3067012	159-181	16	40	0.8	14	22	14	5	531,30
2400953	3067013	172-194	16	40	0.8	14	22	14	4	572,25
2400954	3067014	184-206	16	40	0.8	14	22	14	3	585,90
2400955	3067015	197-219	16	40	0.8	14	22	14	2	619,50
2400956	3067016	210-232	16	40	0.8	14	22	14	2	630,00

Protector de cinta abrazadera ASFA "L" y "S"

MIKALOR

Evita lesiones al cubrir el extremo de la cinta de la abrazadera y además ayuda a identificar la calidad del material gracias a la disponibilidad de dos colores (Rojo: W1-W2 - Azul: W3- W4-W5).

Ref.	Código	Aplicación ancho banda mm.	Color	Envase	€/100
816552	2170441	12 - S	Rojo	100	24,84
816553	2170451	12 - S	Azul	100	24,84
816550	2170401	9 - L	Rojo	100	23,76
816551	2170411	9 - L	Azul	100	23,76



Collarín de seguridad abrazadera ASFA "L" y "S"

MIKALOR

Collar de plástico que se aplica en el tornillo y evita que el destornillador patine durante la aplicación. Disponible en 2 colores para identificar fácilmente la calidad del material (Rojo: W1-W2 - Azul: W3-W4-W5).

Ref.	Código	Color	Envase	Ø Aplicación	€/100
816560	2170371	Rojo	100	Todos Ø disponibles ASFA L y S	15,12
816561	2170380	Azul	100	Todos Ø disponibles ASFA L y S	15,12



Palomilla de apriete abrazadera ASFA L y S

MIKALOR

Permite un apretado fácil y rápido sin uso de herramientas. La palomilla se puede extraer una vez realizado el apriete.

Ref.	Código	Ø Aplicación	Ancho Banda mm	€/100
816570	2170461	Todos Ø disponibles	9-12	59,40



Abrazadera SUPER W1 serie gran presión

MIKALOR

DIN 3017

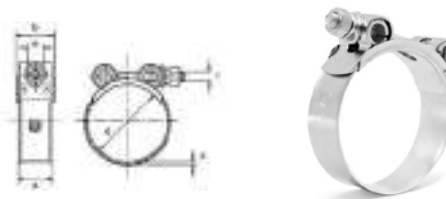

Ref.	Código	b	Ø d Aplicación	r	S	a	Valores máx. (*) Par Nm	Valores máx. (*) Press. Bar	€/100
808500	3018263	19,8	17-19	M5	0,6	18 +0,2	4,5	48	135,00
808501	3018271	19,8	20-22	M5	0,6	18 +0,2	4,5	48	139,00
808502	3018280	19,8	23-25	M5	0,6	18 +0,2	4,5	45	140,00
808503	3018298	19,8	26-28	M6	0,6	18 +0,2	4,5	45	148,00
808504	3018300	22,0	29-31	M6	0,8	20 +0,3	8	42	170,00
808505	3018319	22,0	32-35	M6	0,8	20 +0,3	8	42	180,00
808506	3018327	22,0	36-39	M6	0,8	20 +0,3	8	40	195,00
808507	3018335	22,0	40-43	M7	0,8	20 +0,3	8	40	198,00
808508	3018010	24,5	44-47	M7	1,2	22 +0,2	16	44	268,00
808509	3018028	24,5	48-51	M7	1,2	22 +0,2	16	44	280,00
808510	3018036	24,5	52-55	M7	1,2	22 +0,2	16	40	287,00
808511	3018044	24,5	56-59	M7	1,2	22 +0,2	16	40	293,00
808512	3018052	24,5	60-63	M7	1,2	22 +0,2	16	36	304,00
808513	3018060	24,5	64-67	M8	1,2	22 +0,2	16	36	312,00
808514	3018079	26,5	68-73	M8	1,5	24 +0,4	25	28	390,00
808515	3018087	26,5	74-79	M8	1,5	24 +0,4	25	28	395,00
808516	3018095	26,5	80-85	M8	1,5	24 +0,4	25	28	405,00

Ref.	Código	b	Ø d Aplicación	r	S	a	Valores máx. (*) Par Nm	Valores máx. (*) Press. Bar	€/100
808517	3018108	26,5	86-91	M8	1,5	24 +0,4	25	20	412,00
808518	3018116	26,5	92-97	M8	1,5	24 +0,4	25	20	432,00
808519	3018124	26,5	98-103	M8	1,5	24 +0,4	25	20	440,00
808520	3018132	26,5	104-112	M8	1,5	24 +0,4	25	12	470,00
808521	3018140	26,5	113-121	M8	1,5	24 +0,4	25	12	505,00
808522	3018159	26,5	122-130	M10	1,5	24 +0,4	25	12	545,00
808523	3018167	29,0	131-139	M10	1,7	26 +0,5	50	9	695,00
808524	3018175	29,0	140-148	M10	1,7	26 +0,5	50	9	710,00
808525	3018183	29,0	149-161	M10	1,7	26 +0,5	50	9	730,00
808526	3018191	29,0	162-174	M10	1,7	26 +0,5	50	6	790,00
808527	3018204	29,0	175-187	M10	1,7	26 +0,5	50	6	810,00
808528	3018212	29,0	188-200	M10	1,7	26 +0,5	50	6	820,00
808529	3018220	29,0	201-213	M10	1,7	26 +0,5	50	3	850,00
808530	3018239	29,0	214-226	M10	1,7	26 +0,5	50	3	800,00
808531	3018247	29,0	227-239	M10	1,7	26 +0,5	50	3	900,00
808533	3018255	29,0	240-252	M10	1,7	26 +0,5	50	3	950,00

Abrazadera SUPRA C/T INOX W2 serie gran presión

MIKALOR

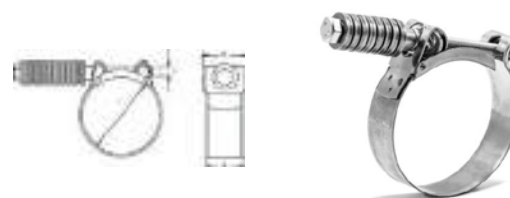

Ref. INOX	Código INOX	b	E mm	Ø d Aplicación	r	a	Valores máx. (*) Par Nm	Valores máx. (*) Press. Bar	€/100
808600	3020100	19,8	8	17-19	M6	18 +0,2	4,5	50	563,20
808601	3020118	19,8	8	19-21	M6	18 +0,2	4,5	50	569,80
808602	3020126	19,8	8	21-23	M6	18 +0,2	4,5	48	572,00
808603	3020134	19,8	8	23-25	M6	18 +0,2	4,5	48	576,40
808604	3020142	19,8	8	25-27	M6	18 +0,2	4,5	45	580,80
808605	3020150	19,8	8	27-29	M6	18 +0,2	4,5	45	585,20
808606	3020169	22	10	29-31	M7	20 +0,3	8	42	814,00
808607	3020177	22	10	31-34	M7	20 +0,3	8	42	825,00
808608	3020185	22	10	34-37	M7	20 +0,3	8	40	913,00
808609	3020193	22	10	37-40	M7	20 +0,3	8	40	924,00
808610	3020206	22	10	40-43	M7	20 +0,3	8	38	1.034,00
808611	3020214	22	10	43-47	M7	20 +0,3	10	38	1.111,00
808612	3020222	22	10	47-51	M7	20 +0,3	10	36	1.133,00
808613	3020230	22	10	51-55	M7	20 +0,3	10	36	1.144,00
808614	3020249	22	10	55-59	M7	20 +0,3	10	34	1.166,00
808615	3020257	22	10	59-63	M7	20 +0,3	10	34	1.177,00
808616	3020265	22	10	63-68	M7	20 +0,3	10	34	1.199,00
808617	3020273	27,5	13	68-73	M8	25 +0,4	25	28	2.090,00

Ref. INOX	Código INOX	b	E mm	Ø d Aplicación	r	a	Valores máx. (*) Par Nm	Valores máx. (*) Press. Bar	€/100
808618	3020281	27,5	13	73-79	M8	25 +0,4	25	28	2.106,50
808619	3020290	27,5	13	79-85	M8	25 +0,4	25	28	2.145,00
808620	3020302	27,5	13	85-91	M8	25 +0,4	25	20	2.167,00
808621	3020310	27,5	13	91-97	M8	25 +0,4	25	20	2.189,00
808622	3020329	27,5	13	91-104	M8	25 +0,4	25	20	2.860,00
808623	3020337	27,5	13	104-112	M8	25 +0,4	25	12	2.915,00
808624	3020345	27,5	13	112-121	M8	25 +0,4	25	12	3.080,00
808625	3020353	27,5	13	121-130	M8	25 +0,4	25	12	3.190,00
808626	3020409	31	15	130-140	M10	28 +0,4	50	9	4.400,00
808627	3020370	31	15	140-150	M10	28 +0,4	50	9	4.675,00
808628	3020388	31	15	150-162	M10	28 +0,4	50	9	4.730,00
808629	3020396	31	15	162-174	M10	28 +0,4	50	6	4.785,00
808630	3020409	31	15	174-187	M10	28 +0,4	50	6	4.840,00
808631	3020417	31	15	187-200	M10	28 +0,4	50	6	4.873,00
808632	3020425	31	15	200-213	M10	28 +0,4	50	3	4.928,00
808633	3020433	31	15	210-226	M10	28 +0,4	50	3	4.972,00
808634	3020441	31	15	226-239	M10	28 +0,4	50	3	5.060,00
808635	3020450	31	15	239-252	M10	28 +0,4	50	3	5.170,00

Abrazadera SUPRA INOX W2 serie gran presión

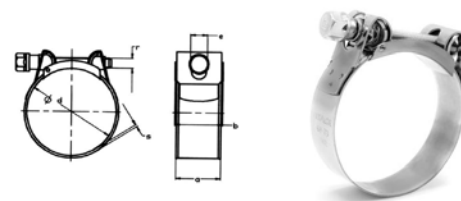

Ref. INOX	Código INOX	b	E mm	Ø d Aplicación	r	a	Valores máx. (*) Par Nm	Valores máx. (*) Press. Bar	€/100
808700	3019012	19,8	8	17-19	M6	18 +0,2	4,5	50	160,65
808701	3019020	19,8	8	19-21	M6	18 +0,2	4,5	50	162,75
808702	3019039	19,8	8	21-23	M6	18 +0,2	4,5	48	164,85
808703	3019047	19,8	8	23-25	M6	18 +0,2	4,5	48	165,90
808704	3019055	19,8	8	25-27	M6	18 +0,2	4,5	48	168,00
808705	3019063	19,8	8	27-29	M6	18 +0,2	4,5	45	173,25
808706	3019071	22,0	10	29-31	M7	20 +0,3	8	45	186,90
808707	3019080	22,0	10	31-34	M7	20 +0,3	8	42	192,15
808708	3019098	22,0	10	34-37	M7	20 +0,3	8	42	201,60
808709	3019100	22,0	10	37-40	M7	20 +0,3	8	40	203,70
808710	3019119	22,0	10	40-43	M7	20 +0,3	8	40	204,75
808711	3019127	22,0	10	43-47	M7	20 +0,3	10	38	285,60
808712	3019135	22,0	10	47-51	M7	20 +0,3	10	38	297,15
808713	3019143	22,0	10	51-55	M7	20 +0,3	10	36	304,50
808714	3019151	22,0	10	55-59	M7	20 +0,3	10	36	310,80
808715	3019160	22,0	10	59-63	M7	20 +0,3	10	34	323,40
808716	3019178	22,0	10	63-68	M7	20 +0,3	10	34	334,95
808717	3019186	27,5	13	68-73	M8	25 +0,4	25	34	426,30
808718	3019194	27,5	13	73-79	M8	25 +0,4	25	28	435,75
808719	3019207	27,5	13	79-85	M8	25 +0,4	25	28	441,00
808720	3019215	27,5	13	85-91	M8	25 +0,4	25	28	451,50
808721	3019223	27,5	13	91-97	M8	25 +0,4	25	20	462,00
808722	3019231	27,5	13	97-104	M8	25 +0,4	25	20	467,25
808723	3019240	27,5	13	104-112	M8	25 +0,4	25	20	505,05

Ref. INOX	Código INOX	b	E mm	Ø d Aplicación	r	a	Valores máx. (*) Par Nm	Valores máx. (*) Press. Bar	€/100
808724	3019258	27,5	13	112-121	M8	25 +0,4	25	12	535,50
808725	3019266	27,5	13	121-130	M8	25 +0,4	25	12	567,00
808726	3019274	31,0	15	130-140	M10	28 +0,4	50	12	724,50
808727	3019282	31,0	15	140-150	M10	28 +0,4	50	9	744,45
808728	3019290	31,0	15	150-162	M10	28 +0,4	50	9	788,55
808729	3019303	31,0	15	162-174	M10	28 +0,4	50	9	819,00
808730	3019311	31,0	15	174-187	M10	28 +0,4	50	6	838,95
808731	3019320	31,0	15	187-200	M10	28 +0,4	50	6	850,50
808732	3019338	31,0	15	200-213	M10	28 +0,4	50	6	871,50
808733	3019346	31,0	15	213-226	M10	28 +0,4	50	3	893,55
808736	3019354	31,0	15	226-239	M10	28 +0,4	45	3	964,95
808737	3019362	31,0	15	239-252	M10	28 +0,4	45	3	1.018,50
808738	3019370	31,0	15	252-265	M10	28 +0,4	45	3	1.212,75
808739	3019477	31,0	15	265-278	M10	28 +0,4	45	3	1.291,50
808740	3019392	31,0	15	278-291	M10	28 +0,4	45	3	1.365,00
808741	3019403	31,0	15	291-304	M10	28 +0,4	45	3	1.449,00
808742	3019411	31,0	15	304-317	M10	28 +0,4	45	3	1.533,00
808743	3019485	31,0	15	317-330	M10	28 +0,4	45	3	1.627,50
808744	3019422	31,0	15	330-343	M10	28 +0,4	45	3	1.732,50
808745	3019433	31,0	15	343-356	M10	28 +0,4	45	3	1.858,50
808746	3019444	31,0	15	356-369	M10	28 +0,4	45	3	1.995,00
808747	3019455	31,0	15	369-382	M10	28 +0,4	45	3	2.136,75
808748	3019499	31,0	15	382-395	M10	28 +0,4	45	3	2.341,50
808749	3019500	31,0	15	395-408	M10	28 +0,4	45	3	2.509,50

Abrazadera SUPRA W5 serie gran presión

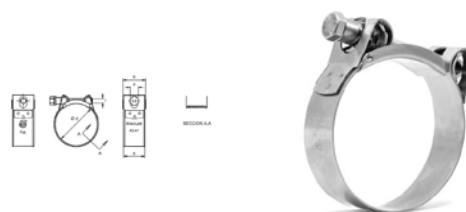

Ref.	Código	b	E mm	Ø d Aplicación	r	a	Valores máx. (*) Par Nm	Valores máx. (*) Press. Bar	€/100
816600	3013614	19,8	8	17-19	M6	18 +0,2	10	40	525,00
816601	3013622	19,8	8	19-21	M6	18 +0,2	10	40	537,60
816602	3013630	19,8	8	21-23	M6	18 +0,2	10	40	546,00
816603	3013649	19,8	8	23-25	M6	18 +0,2	10	40	564,90
816604	3013657	19,8	8	25-27	M6	18 +0,2	10	40	588,00
816605	3013665	19,8	8	27-29	M6	18 +0,2	10	40	598,50
816606	3013673	22,0	11	29-31	M7	20 +0,3	12	35	609,00
816607	3013681	22,0	11	31-34	M7	20 +0,3	12	35	624,75
816608	3013690	22,0	11	34-37	M7	20 +0,3	12	35	635,25
816609	3013702	22,0	11	37-40	M7	20 +0,3	12	35	729,75
816610	3013710	22,0	11	40-43	M7	20 +0,3	12	35	735,00
816611	3013729	22,0	11	43-47	M7	20 +0,3	12	35	1.018,50
816612	3013737	22,0	11	47-51	M7	20 +0,3	16	30	1.081,50
816613	3013745	22,0	11	51-55	M7	20 +0,3	16	30	1.102,50
816614	3013753	22,0	11	55-59	M7	20 +0,3	16	30	1.076,25
816615	3013761	22,0	11	59-63	M7	20 +0,3	16	30	1.165,50
816616	3013770	22,0	11	63-68	M7	20 +0,3	16	30	1.207,50
816617	3013788	27,5	13	68-73	M8	25 +0,4	30	20	1.512,00
816618	3013796	27,5	13	73-79	M8	25 +0,4	30	20	1.575,00
816619	3013809	27,5	13	79-85	M8	25 +0,4	30	20	1.590,75
816620	3013817	27,5	13	85-91	M8	25 +0,4	30	15	1.596,00
816621	3013825	27,5	13	91-97	M8	25 +0,4	30	15	1.680,00
816622	3013833	27,5	13	97-104	M8	25 +0,4	30	15	1.764,00
816623	3013841	27,5	13	104-112	M8	25 +0,4	30	10	1.837,50

Ref.	Código	b	E mm	Ø d Aplicación	r	a	Valores máx. (*) Par Nm	Valores máx. (*) Press. Bar	€/100
816624	3013850	27,5	13	112-121	M8	25 +0,4	30	10	1.974,00
816625	3013868	27,5	13	121-130	M8	25 +0,4	30	10	2.100,00
816626	3013876	31,0	15	130-140	M10	28 +0,4	45	6	2.900,10
816627	3013884	31,0	15	140-150	M10	28 +0,4	45	6	2.973,60
816628	3013892	31,0	15	150-162	M10	28 +0,4	45	6	3.069,15
816629	3013905	31,0	15	162-174	M10	28 +0,4	45	3	3.091,20
816630	3013913	31,0	15	174-187	M10	28 +0,4	45	3	3.140,55
816631	3013921	31,0	15	187-200	M10	28 +0,4	45	3	3.186,75
816632	3013930	31,0	15	200-213	M10	28 +0,4	45	3	3.234,00
816633	3013948	31,0	15	213-226	M10	28 +0,4	45	3	3.276,00
816635	3013964	31,0	15	239-252	M10	28 +0,4	45	3	3.370,50
816636	3013956	31,0	15	226-239	M10	28 +0,4	45	3	3.307,50
816638	3013971	31,0	15	252-265	M10	28 +0,4	45	3	3.790,50
816639	3013981	31,0	15	265-278	M10	28 +0,4	45	3	3.853,50
816640	3013982	31,0	15	278-291	M10	28 +0,4	45	3	3.927,00
816641	3013983	31,0	15	291-304	M10	28 +0,4	45	3	4.126,50
816642	3013984	31,0	15	304-317	M10	28 +0,4	45	3	4.221,00
816643	3013985	31,0	15	317-330	M10	28 +0,4	45	3	4.557,00
816644	3013986	31,0	15	330-343	M10	28 +0,4	45	3	4.924,50
816645	3013991	31,0	15	343-356	M10	28 +0,4	45	3	5.318,25
816646	3013992	31,0	15	356-369	M10	28 +0,4	45	3	5.738,25
816647	3013993	31,0	15	369-382	M10	28 +0,4	45	3	6.195,00
816648	3013994	31,0	15	382-395	M10	28 +0,4	45	3	6.930,00



Abrazadera SUPRA doble tornillo W2

MIKALOR

Material: Banda y puente de acero inoxidable W2 - AISI 430



Ref.	Código	Ø D +0.3-0.2	A ±0.3	Ø d Aplicación	S ±0.3	B ±0.5	Par de apriete (Nm)	€/100
2400957	3170001	280	28	270-280	1.2	31	40	3.212,10
2400958	3170003	290	28	280-290	1.2	31	40	3.228,85
2400959	3170005	295	28	285-295	1.2	31	40	3.245,59
2400960	3170007	325	28	315-325	1.2	31	40	3.282,05
2400961	3170009	355	28	345-355	1.2	31	40	3.319,48
2400962	3170011	385	28	370-385	1.2	31	40	3.357,91
2400963	3170013	410	28	395-410	1.2	31	40	3.398,30
2400964	3170015	435	28	420-435	1.2	31	40	3.406,32
2400965	3170017	460	28	445-460	1.2	31	40	3.444,97
2400966	3170019	485	28	470-485	1.2	31	40	3.450,67
2400967	3170021	510	28	495-510	1.2	31	40	3.523,23
2400968	3170023	535	28	520-535	1.2	31	40	3.788,46

Ref.	Código	Ø D +0.3-0.2	A ±0.3	Ø d Aplicación	S ±0.3	B ±0.5	Par de apriete (Nm)	€/100
2400969	3170025	560	28	545-560	1.2	31	40	3.868,20
2400970	3170027	585	28	570-585	1.2	31	40	3.953,49
2400971	3170029	610	28	595-610	1.2	31	40	4.039,80
2400972	3170031	635	28	620-635	1.2	31	40	4.129,17
2400973	3170033	665	28	650-665	1.2	31	40	4.176,88
2400974	3170035	695	28	680-695	1.2	31	40	4.322,20
2400975	3170037	730	28	715-730	1.2	31	40	4.666,78
2400976	3170039	755	28	740-755	1.2	31	40	4.870,60
2400977	3170041	780	28	765-780	1.2	31	40	5.088,69
2400978	3170043	805	28	790-805	1.2	31	40	5.496,91
2400979	3170045	835	28	820-835	1.2	31	40	5.838,92

Abrazadera SUPRA INOX W4 serie gran presión

MIKALOR

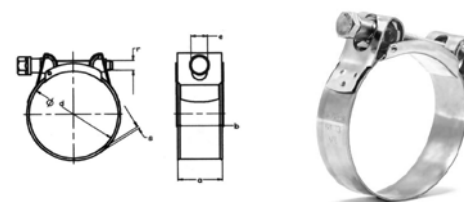

Ref. INOX	Código INOX	b	E mm	Ø d Aplicación	r	a	Valores máx. (*) Par Nm	Valores máx. (*) Press. Bar	€/100
808800	3013016	19,8	8	17-19	M6	18 +0,2	10	40	429,45
808801	3013024	19,8	8	19-21	M6	18 +0,2	10	40	451,50
808802	3013032	19,8	8	21-23	M6	18 +0,2	10	40	462,00
808803	3013040	19,8	8	23-25	M6	18 +0,2	10	40	467,25
808804	3013059	19,8	8	25-27	M6	18 +0,2	10	40	472,50
808805	3013067	19,8	8	27-29	M6	18 +0,2	10	40	514,50
808806	3013075	22,0	11	29-31	M7	20 +0,3	12	35	572,25
808807	3013083	22,0	11	31-34	M7	20 +0,3	12	35	580,00
808808	3013091	22,0	11	34-37	M7	20 +0,3	12	35	590,00
808809	3013104	22,0	11	37-40	M7	20 +0,3	12	35	635,25
808810	3013112	22,0	11	40-43	M7	20 +0,3	12	35	651,00
808811	3013120	22,0	11	43-47	M7	20 +0,3	12	35	840,00
808812	3013139	22,0	11	47-51	M7	20 +0,3	16	30	887,25
808813	3013147	22,0	11	51-55	M7	20 +0,3	16	30	903,00
808814	3013155	22,0	11	55-59	M7	20 +0,3	16	30	929,25
808815	3013163	22,0	11	59-63	M7	20 +0,3	16	30	955,50
808816	3013171	22,0	11	63-68	M7	20 +0,3	16	30	1.013,25
808817	3013180	27,5	13	68-73	M8	25 +0,4	30	20	1.302,00
808818	3013198	27,5	13	73-79	M8	25 +0,4	30	20	1.359,75
808819	3013200	27,5	13	79-85	M8	25 +0,4	30	20	1.375,50
808820	3013219	27,5	13	85-91	M8	25 +0,4	30	15	1.391,25
808821	3013227	27,5	13	91-97	M8	25 +0,4	30	15	1.449,00
808822	3013235	27,5	13	97-104	M8	25 +0,4	30	15	1.501,50
808823	3013243	27,5	13	104-112	M8	25 +0,4	30	10	1.575,00

Ref. INOX	Código INOX	b	E mm	Ø d Aplicación	r	a	Valores máx. (*) Par Nm	Valores máx. (*) Press. Bar	€/100
808824	3013251	27,5	13	112-121	M8	25 +0,4	30	10	1.601,25
808825	3013260	27,5	13	121-130	M8	25 +0,4	30	10	1.774,50
808826	3013278	31,0	15	130-140	M10	28 +0,4	45	6	2.614,50
808827	3013286	31,0	15	140-150	M10	28 +0,4	45	6	2.625,00
808828	3013294	31,0	15	150-162	M10	28 +0,4	45	6	2.730,00
808829	3013307	31,0	15	162-174	M10	28 +0,4	45	3	2.782,50
808830	3013315	31,0	15	174-187	M10	28 +0,4	45	3	2.808,75
808831	3013323	31,0	15	187-200	M10	28 +0,4	45	3	2.835,00
808832	3013331	31,0	15	200-213	M10	28 +0,4	45	3	2.887,50
808833	3013340	31,0	15	213-226	M10	28 +0,4	45	3	2.919,00
808834	3013358	31,0	15	226-239	M10	28 +0,4	45	3	2.992,50
808835	3013366	31,0	15	239-252	M10	28 +0,4	45	3	3.013,50
808836	3013374	31,0	15	252-265	M10	25 +0,4	45	3	3.360,00
808837	3013390	31,0	15	265-278	M10	25 +0,4	45	3	3.412,50
808838	3013422	31,0	15	278-291	M10	25 +0,4	45	3	3.465,00
808839	3013433	31,0	15	291-304	M10	28 +0,4	45	3	3.517,50
808840	3013444	31,0	15	304-317	M10	28 +0,4	45	3	3.727,50
808841	3013403	31,0	15	317-330	M10	28 +0,4	45	3	4.410,00
808842	3013455	31,0	15	330-343	M10	28 +0,4	45	3	4.690,00
808843	3013466	31,0	15	343-356	M10	28 +0,4	45	3	5.065,00
808844	3013477	31,0	15	356-369	M10	28 +0,4	45	3	5.465,00
808845	3013488	31,0	15	369-382	M10	28 +0,4	45	3	5.900,00
808846	3013499	31,0	15	382-395	M10	28 +0,4	45	3	6.600,00

Abrazadera SUPRA doble tornillo W4

MIKALOR

Material: Banda y puente de acero inoxidable W2 - AISI 430



Ref.	Código	Ø D +0.3 -0.2	A ±0.3	Ø d Aplicación	S ±0.3	B ±0.5	Par de apriete (Nm)	€/100
2400980	3180001	280	28	270-280	1.2	31	40	4.679,95
2400981	3180003	290	28	280-290	1.2	31	40	4.717,95
2400982	3180005	295	28	285-295	1.2	31	40	4.739,59
2400983	3180007	325	28	315-325	1.2	31	40	4.781,42
2400984	3180009	355	28	345-355	1.2	31	40	4.817,56
2400985	3180011	385	28	370-385	1.2	31	40	4.865,17
2400986	3180013	410	28	395-410	1.2	31	40	4.923,35
2400987	3180015	435	28	420-435	1.2	31	40	4.970,95
2400988	3180017	460	28	445-460	1.2	31	40	5.007,10
2400989	3180019	485	28	470-485	1.2	31	40	5.066,16
2400990	3180021	510	28	495-510	1.2	31	40	5.112,92
2400991	3180023	535	28	520-535	1.2	31	40	5.911,65

Ref.	Código	Ø D +0.3 -0.2	A ±0.3	Ø d Aplicación	S ±0.3	B ±0.5	Par de apriete (Nm)	€/100
2400992	3180025	560	28	545-560	1.2	31	40	6.202,64
2400993	3180027	585	28	570-585	1.2	31	40	6.342,69
2400994	3180029	610	28	595-610	1.2	31	40	6.513,95
2400995	3180031	635	28	620-635	1.2	31	40	6.847,07
2400996	3180033	665	28	650-665	1.2	31	40	7.203,52
2400997	3180035	695	28	680-695	1.2	31	40	8.228,38
2400998	3180037	730	28	715-730	1.2	31	40	8.672,64
2400999	3180039	755	28	740-755	1.2	31	40	9.446,03
2401000	3180041	780	28	765-780	1.2	31	40	9.973,84
2401001	3180043	805	28	790-805	1.2	31	40	10.892,71
2401002	3180045	835	28	820-835	1.2	31	40	11.519,80

Abrazadera SUPRA doble tornillo W5

MIKALOR

Material: Banda y puente de acero inoxidable W2 - AISI 430 W5 - AISI 316



Ref.	Código	Ø D +0.3 -0.2	A ±0.3	Ø d Aplicación	S ±0.3	B ±0.5	Par de apriete (Nm)	€/100
2401003	3190001	280	28	270-280	1.2	31	30	4.850,00
2401004	3190003	290	28	280-290	1.2	31	30	4.876,73
2401005	3190005	295	28	285-295	1.2	31	30	4.913,17
2401006	3190007	325	28	315-325	1.2	31	30	4.988,55
2401007	3190009	355	28	345-355	1.2	31	30	5.027,18
2401008	3190011	385	28	370-385	1.2	31	30	5.078,02
2401009	3190013	410	28	395-410	1.2	31	30	5.140,12
2401010	3190015	435	28	420-435	1.2	31	30	5.190,95
2401011	3190017	460	28	445-460	1.2	31	30	5.229,58
2401012	3190019	485	28	470-485	1.2	31	30	5.292,75
2401013	3190021	510	28	495-510	1.2	31	30	5.343,24
2401014	3190023	535	28	520-535	1.2	31	30	6.197,59

Ref.	Código	Ø D +0.3 -0.2	A ±0.3	Ø d Aplicación	S ±0.3	B ±0.5	Par de apriete (Nm)	€/100
2401015	3190025	560	28	545-560	1.2	31	30	6.530,77
2401016	3190027	585	28	570-585	1.2	31	30	6.888,96
2401017	3190029	610	28	595-610	1.2	31	30	7.274,01
2401018	3190031	635	28	620-635	1.2	31	30	7.687,94
2401019	3190033	665	28	650-665	1.2	31	30	8.162,57
2401020	3190035	695	28	680-695	1.2	31	30	8.675,18
2401021	3190037	730	28	715-730	1.2	31	30	9.228,79
2401022	3190039	755	28	740-755	1.2	31	30	9.826,69
2401023	3190041	780	28	765-780	1.2	31	30	10.472,43
2401024	3190043	805	28	790-805	1.2	31	30	11.169,82
2401025	3190045	835	28	820-835	1.2	31	30	12.431,41

Abrazadera P.GOMA DIN3016 AGD W1

MIKALOR



Ref.	Código	Ancho fleje	Ø d Aplicación	Para tornillos	€/100
818800	3003856	12	5	M5	40,88
818801	3003864	12	6	M5	41,53
818802	3003880	12	8	M5	43,39
818803	3003901	12	10	M5	45,24
818804	3003928	12	12	M5	54,07
818805	3003936	12	13	M5	55,16
818806	3003944	12	14	M5	57,99
818807	3003952	12	15	M5	60,39
818808	3003960	12	16	M5	63,33
818809	3003979	12	17	M5	63,88
818810	3003987	12	18	M5	65,30
818811	3003995	12	19	M5	65,73
818812	3004007	12	20	M5	66,60
818813	3004015	12	21	M5	73,03
818814	3004023	12	22	M5	73,36
818815	3004031	12	23	M5	75,21
818816	3004040	12	24	M5	76,96
818817	3004058	12	25	M5	77,39
818818	3004066	12	26	M5	78,81
818819	3004074	12	27	M5	81,65
818820	3004082	12	28	M5	82,52
818821	3004664	15	6	M6	46,55
818822	3004680	15	8	M6	47,31
818823	3004701	15	10	M6	48,51
818824	3004728	15	12	M6	62,03
818825	3004736	15	13	M6	63,44
818826	3004744	15	14	M6	64,86
818827	3004752	15	15	M6	66,82
818828	3004760	15	16	M6	68,67
818829	3004779	15	17	M6	70,96
818830	3004787	15	18	M6	72,93
818831	3004795	15	19	M6	74,02
818832	3004808	15	20	M6	76,30
818833	3004816	15	21	M6	78,05
818834	3004824	15	22	M6	79,25

Ref.	Código	Ancho fleje	Ø d Aplicación	Para tornillos	€/100
818835	3004832	15	23	M6	80,66
818836	3004859	15	25	M6	81,21
818837	3004867	15	26	M6	82,52
818838	3004883	15	28	M6	83,28
818839	3004904	15	30	M6	85,35
818840	3004920	15	32	M6	92,11
818841	3004947	15	34	M6	93,20
818842	3004955	15	35	M6	95,38
818843	3004971	15	37	M6	97,01
818844	3004980	15	38	M6	99,63
818845	3005000	15	40	M6	100,94
818846	3005510	20	11	M8	105,95
818847	3005528	20	12	M8	107,26
818848	3005536	20	13	M8	109,44
818849	3005544	20	14	M8	111,08
818850	3005552	20	15	M8	113,26
818851	3005560	20	16	M8	114,78
818852	3005562	20	17	M8	147,15
818853	3005579	20	18	M8	116,63
818854	3005587	20	19	M8	118,81
818855	3005595	20	20	M8	120,99
818856	3005608	20	21	M8	129,71
818857	3005616	20	22	M8	130,80
818858	3005624	20	23	M8	134,07
818859	3005632	20	24	M8	135,16
818860	3005640	20	25	M8	136,25
818861	3005667	20	27	M8	139,52
818862	3005675	20	28	M8	141,70
818863	3005691	20	30	M8	142,79
818864	3005712	20	32	M8	143,88
818865	3005739	20	34	M8	159,14
818866	3005747	20	35	M8	161,32
818867	3005755	20	36	M8	163,50
818868	3005771	20	38	M8	164,59
818869	3005798	20	40	M8	166,77

Grapa

desa



Ref.	Código	Ø	Ø mm	€/100
808900	11000066	-	6	8,40
808901	11000088	-	8	8,80
808902	11000101	1/8"	10	9,17
808903	11000121	-	12	10,10
808904	11000143	1/4"	14	11,93
808905	11000150	-	15	13,66
808906	11000165	-	16*	14,29
808907	11000187	3/8"	18	15,42

Ref.	Código	Ø	Ø mm	€/100
808908	11000202	-	20*	19,84
808909	11000220	1/2"	22	21,65
808910	11000250	-	25*	24,80
808911	11000264	3/4"	26	25,19
808912	11000286	-	28	25,97
808913	11000320	1"	32*	31,92
808914	11000400	-	40*	48,52
808915	11000500	-	50*	62,40

Abrazadera P. GOMA DIN3016 AGID W4

MIKALOR

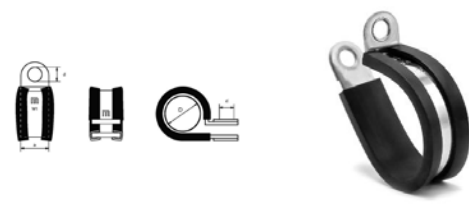

Ref.	Código	Ancho fleje	Ø d Aplicación	Para tornillos	€/100
818900	43003859	12	5	M5	59,63
818901	43003867	12	6	M5	60,50
818902	43003883	12	8	M5	71,73
818903	43003904	12	10	M5	73,14
818904	43003920	12	12	M5	86,39
818905	43003939	12	13	M5	96,47
818906	43003947	12	14	M5	97,23
818907	43003955	12	15	M5	98,54
818908	43003963	12	16	M5	99,09
818909	43003971	12	17	M5	100,18
818910	43003980	12	18	M5	101,81
818911	43003998	12	19	M5	102,36
818912	43004000	12	20	M5	102,90
818913	43004018	12	21	M5	103,88
818914	43004026	12	22	M5	104,54
818915	43004034	12	23	M5	105,84
818916	43004042	12	24	M5	106,17
818917	43004050	12	25	M5	106,50
818918	43004069	12	26	M5	107,81
818919	43004077	12	27	M5	108,57
818920	43004085	12	28	M5	110,09
818921	43004667	15	6	M6	79,59
818922	43004683	15	8	M6	80,45
818923	43004704	15	10	M6	80,99
818924	43004720	15	12	M6	87,53
818925	43004739	15	13	M6	103,55
818926	43004747	15	14	M6	104,43
818927	43004755	15	15	M6	104,75
818928	43004763	15	16	M6	105,73
818929	43004771	15	17	M6	106,82
818930	43004780	15	18	M6	107,91
818931	43004798	15	19	M6	109,00
818932	43004800	15	20	M6	110,09
818933	43004819	15	21	M6	111,18
818934	43004827	15	22	M6	112,27

Ref.	Código	Ancho fleje	Ø d Aplicación	Para tornillos	€/100
818935	43004835	15	23	M6	113,36
818936	43004851	15	25	M6	114,45
818937	43004860	15	26	M6	115,54
818938	43004886	15	28	M6	117,72
818939	43004907	15	30	M6	119,90
818940	43004923	15	32	M6	122,08
818941	43004940	15	34	M6	128,62
818942	43004958	15	35	M6	136,25
818943	43004974	15	37	M6	155,87
818944	43004982	15	38	M6	156,96
818945	43005002	15	40	M6	158,05
818946	43005512	20	11	M8	151,51
818947	43005520	20	12	M8	152,60
818948	43005539	20	13	M8	153,69
818949	43005547	20	14	M8	154,78
818950	43005555	20	15	M8	155,87
818951	43005563	20	16	M8	156,96
818952	43005571	20	18	M8	163,50
818953	43005580	20	19	M8	168,95
818954	43005598	20	20	M8	173,31
818955	43005600	20	21	M8	190,75
818956	43005619	20	22	M8	191,84
818957	43005627	20	23	M8	192,93
818958	43005635	20	24	M8	194,02
818959	43005643	20	25	M8	195,11
818960	43005661	20	27	M8	196,20
818961	43005670	20	28	M8	198,38
818962	43005696	20	30	M8	199,47
818963	43005715	20	32	M8	221,27
818964	43005731	20	34	M8	226,72
818965	43005740	20	35	M8	228,90
818966	43005758	20	36	M8	236,53
818967	43005774	20	38	M8	243,07
818968	43005790	20	40	M8	249,61

Grapa puente

desa



Ref.	Código	Ø	Ø mm	€/100
809000	11000252	-	25*	28,53
809001	11000321	1"	32*	35,42
809002	11000374	-	37	36,90
809003	11000402	1 1/4"	40*	46,27

Ref.	Código	Ø	Ø mm	€/100
809004	11000422	1 1/2"	42	53,11
809005	11000473	-	47	50,40
809006	11000502	-	50*	59,57

Abrazadera simple



Ref.	Código	Para tubo hierro	Para tubo de cobre mm	Para tubo plástico mm	Tipo	€/100
809201	60185	-	8	-	AM 8	34,85
809202	60186	1/8"	10	-	AM 10	34,35
809203	60187	-	12	-	AM 12	36,75
809204	60188	1/4"	14	16	AM 14	36,75
809205	60189	-	15	-	AM 15/16	35,80
809206	60190	3/8"	18	-	AM 18	36,10
809207	60191	-	-	20	AM 20	38,00

Ref.	Código	Para tubo hierro	Para tubo de cobre mm	Para tubo plástico mm	Tipo	€/100
809208	60192	1/2"	22	-	AM 22	39,80
809209	60193	-	-	-	AM 24	41,60
809210	60194	3/4"	-	25	AM 25/26	41,60
809211	60195	-	28	-	AM 28	42,50
809212	60196	-	-	-	AM 30	44,60
809213	60209	-	-	32	AM 32	24,71
809215	60211	-	-	-	AM 37	27,62

Abrazadera colgante M10



Ref.	Código	Ø	Ø mm	€/100
809500	15300102	1"	35	195,07
809501	15300142	1 1/4"	42	200,87
809502	15300120	1 1/2"	48	212,94
809503	15300203	2"	60	244,89
809504	15300212	2 1/2"	76	263,99
809505	15300304	2"	90	336,12
809506	15300405	4"	115	366,26
809507	15300506	5"	140	401,73
809508	15300607	6"	170	544,58



Abrazadera simple plastificada



Ref.	Código	Ø	Ø mm	Tipo	€/100
809300	15590018	3/8"	18	M8	115,70
809301	15590022	1/2"	22	M8	131,80
809302	15590028	3/4"	28	M8	142,32
809303	15590035	1"	35	M8	152,33
809304	15590042	1 1/4"	42	M8	164,84
809305	15590048	1 1/2"	48	M8	178,32
809306	15590054	1 3/4"	54	M8+M10	194,10

Ref.	Código	Ø	Ø mm	Tipo	€/100
809308	15590075	2 1/2"	75	M8+M10	238,10
809309	15590090	3"	90	M8+M10	252,63
809310	15590110	3 1/2"	110	M8+M10	273,67
809311	15590115	4"	115	M8+M10	310,87
809312	15590140	5"	140	M8+M10	350,06
809313	15590165	6"	165	M8+M10	412,56



Grapilla GC



Ref.	Código	Medidas clavo mm	Para cables mm	Tipo	€/100
PARA CABLE PARALELO					
810301	98864	1,5 x 16	2 x 0,4-2 x 0,7-2 x 1	GC 0-2	7,41
PARA CABLE PLANO O PARALELO					
810302	98850	1,5 x 16	2 x 0,75	GC 0-1	7,39
810303	98865	1,8 x 16	2 x 1-3 x 0,7	GC 0-3	7,51
PARA CABLE PLANO					
810304	98851	2 x 20	2 x 1	GC 1	8,77
810305	98852	2 x 20	2 x 1,5 -2 x 2,5	GC 2	9,60
810306	98853	2 x 25	3 x 1	GC 3	10,48

Ref.	Código	Medidas clavo mm	Para cables mm	Tipo	€/100
PARA CABLE REDONDO					
810307	98854	2 x 20	1 x 1-2 x 0,5	GC 4	9,17
810308	98855	2 x 20	1 x 1,5-2 x 0,75	GC 5	9,26
810309	98856	2 x 20	2 x 1	GC 6	9,92
810310	98857	2 x 25	2 x 1-2 x 1,5	GC 7	10,66
810311	98858	2 x 25	2 x 2,5	GC 8	10,89
810312	98859	2 x 30	2 x 4-3 x 2,5	GC 9	11,98
810313	98860	2 x 30	2 x 4-3 x 4	GC 10	13,34
810314	98861	2 x 30	3 x 6-4 x 2,5	GC 12	15,66
810315	98866	2 x 35	4 x 6	GC 14	19,35
810316	98863	2,50 x 30	Coaxial TV	GC TV	11,22

Abarcón M6/M8



Ref.	Código	Ø	Ø mm	Tipo	€/100
809600	15800014	1/4"	13	M6	37,50
809601	15800038	3/8"	16	M6	38,70
809602	15800120	1/2"	21	M6	43,55
809603	15800340	3/4"	28	M6	51,97
809604	15801000	1"	33	M6	57,20
809605	15801013	1 1/4"	42	M6	74,88

Ref.	Código	Ø	Ø mm	Tipo	€/100
809606	15801014	1 1/4"	42	M8	100,79
809607	15801120	1 1/4"	48	M8	117,93
809608	15802000	2"	60	M8	130,36
809609	15802120	2 1/2"	75	M8	160,81
809610	15803000	3"	88	M8	177,31

Conjunto cinta perforada + cabezales



Ref.	Código	Contenido	Envase	Ancho Banda mm	€/100
819000	3035101	Conjunto cinta perforada + cabezales W2	3 m + 8 cabezales	8	1.962,00
819001	3035111	Cinta perforada W2	25 m	8	9.792,00
819002	3035121	Cabezales para cinta sin fin continua W2	50 unidades	8	93,10
819003	3035601	Conjunto cinta perforada + cabezales W2	3 m + 6 cabezales	14	2.346,00
819004	3035611	Cinta perforada W2	25 m	14	11.304,00
819005	3035621	Cabezales para cinta sin fin continua W2	50 Unidades	14	110,16
819006	3035301	Conjunto cinta perforada + cabezales W4	3 m + 8 cabezales	8	3.606,00
819007	3035311	Cinta perforada W4	25 m	8	12.307,00
819008	3035321	Cabezales para cinta sin fin continua W4	50 unidades	8	150,12
819009	3035801	Conjunto cinta perforada + cabezales W4	3 m + 6 cabezales	14	4.315,00
819010	3035811	Cinta perforada W4	25 m	14	17.122,00
819011	3035821	Cabezales para cinta sin fin continua W4	50 unidades	14	224,64

06



Carril metálico para grapa pinza CSG



Ref.	Código	Tipo	€/100
816899	508332	CSG 20x10 2 m	15,44



Brida Nylon



Ref.	Código	Tipo	€/100
837489	37489	Brida BN 2,5x160 natural	3,27
837490	37490	Brida BN 3,6x300 natural	7,36
837573	37573	Brida UBN 3,6x200 negra	5,05
837582	37582	Brida BN 4,8x250 natural	8,04
837583	37583	Brida BN 4,8x370 natural	14,39
837653	37653	Brida BN 4,8x350 natural	11,22
837708	37708	Brida BN 4,8x430 natural	18,32
837949	37949	Brida BN 7,6x300 natural	18,17
837996	37996	Brida BN 7,6x450 natural	36,63
837997	37997	Brida BN 7,6x550 natural	45,56
837998	37998	Brida BN 8,8x760 natural	73,70
838000	38000	Brida BN 8,8x810 natural	79,10
838002	38002	Brida BN 8,8x1168 natural	137,10
869363	69363	Brida UBN 2,5x160 negra	3,27
869364	69364	Brida UBN 3,6x300 negra	7,36

Ref.	Código	Tipo	€/100
869365	69365	Brida UBN 4,5x150 negra	5,24
869366	69366	Brida UBN 4,5x190 negra	5,30
869367	69367	Brida UBN 4,8x250 negra	8,04
869368	69368	Brida UBN 4,8x350 negra	11,22
869369	69369	Brida UBN 4,8x370 negra	14,39
869370	69370	Brida UBN 4,8x430 negra	18,32
869372	69372	Brida UBN 7,2x200 negra	14,91
869373	69373	Brida UBN 7,6x300 negra	18,17
869374	69374	Brida UBN 7,6x450 negra	36,63
869375	69375	Brida UBN 7,6x550 negra	45,56
869376	69376	Brida UBN 8,8x760 negra	73,70
869377	69377	Brida UBN 8,8x810 negra	79,10
869378	69378	Brida UBN 12,6x550 negra	77,80
869379	69379	Brida UBN 8,8x1168 negra	145,40



Herramienta PRO-08



Homologada reglamento CIP, banco oficial de pruebas de armas de fuego nº77/99. Semiautomática de tiro indirecto a través de buterola. Con regulador de potencia, antirretroceso y silenciador, uso de impulsor ROJO Y AMARILLO. Suministro con buterola C-12. Utilizable con clavos tipo C-12, CE, LM6-8, LM6-12, FT



Ref.	Código	Tipo	€/ u.
810700	2000008	PRO-08	854,00
810701	9000001	Buterola C-8 PRO-08	84,36
810605	9000031	Spray de aceite	21,20

Herramienta PRO-12



Homologada reglamento CIP, banco oficial de pruebas de armas de fuego nº77/99. Semiautomática de tiro indirecto a través de buterola. Con regulador de potencia, antirretroceso y silenciador, uso de impulsor ROJO Y AMARILLO. Suministro con buterola C-12. Utilizable con clavos tipo C-12, CE, LM6-8, LM6-12, FT



Ref.	Código	Tipo	€/ u.
810600	2000012	PRO-12	1.531,84
810601	9000020	Buterola C-12	154,19
810602	9000021	Buterola LM6-8	119,56
810603	9000022	Buterola LM6-12	160,88
810604	9000023	Buterola FT	162,68

Herramienta PRO-06 GAS



Herramienta a carga de gas para clavos P-C6 y P-CE M6 en peine. Peso: 3,86 kg. Total antiretroceso. Gran autonomía de disparo con cargador de 40 clavos. Pasa trabajos intensivos de fijación: Electricistas, fontaneros y plaquistas.



Ref.	Código	Tipo	€/u.
816800	800001	Herramienta PRO-06 40	2.149,75
816801	800005	Herramienta PRO-06 20	1.705,44
816802	800002	Batería PRO-06	265,37
816803	800003	Cargador de batería PRO-06	85,27

Clavo y carga de gas para PRO-06 GAS. Clavo P-CE en peine con carga de gas



Ref.	Código	Características	Long.	€/100
816900	800017	Clavo P-16DD con carga de gas	16DD	19,84
816901	800020	Clavo P-20 con carga de gas	20	16,92
816902	800025	Clavo P-25 con carga de gas	25	17,37
816903	800030	Clavo P-30 con carga de gas	30	18,29
816904	800035	Clavo P-35 con carga de gas	35	19,73
816905	800040	Clavo P-40 con carga de gas	40	21,10
816906	800043	Clavo P-43 con carga de gas	43	23,75

Ref.	Código	Características	Long.	€/100
816907	801117	Clavo P-700 16DD con carga de gas	16DD	26,07
816908	801120	Clavo P-700 20 con carga de gas	20	21,57
816909	801125	Clavo P-700 25 con carga de gas	25	22,02
816910	801130	Clavo P-700 30 con carga de gas	30	23,38
816911	801135	Clavo P-700 35 con carga de gas	35	24,94
816912	801140	Clavo P-700 40 con carga de gas	40	25,10
816913	801143	Clavo P-700 43 con carga de gas	43	25,66

Clavo y carga de gas para PRO-06 GAS. Carga de gas adicional



Ref.	Código	Descripción	€/100
816950	802100	Carga de gas P-1000	34,56
816951	802070	Carga de gas P-700	34,70



Clavo P-C8 en peine



Peines de 10 clavos C8. Para herramientas: PRO-08 AUTO

Ref.	Código	Longitud mm	€/100	Ref.	Código	Longitud mm	€/100
811000	1100116	16	27,57	811005	1100137	37	31,60
811004	1100119	19	25,51	811006	1100142	42	33,53
811001	1100122	22	26,43	811007	1100147	47	35,54
811002	1100127	27	29,17	811008	1100152	52	36,98
811003	1100132	32	31,20				



Impulsor de pólvora



Peines de 10 impulsores calibre Ø 6,8 x 11mm.
Verde: Baja potencia. Amarillo: Potencia media.
Rojo: Alta potencia. Manipular según instrucciones de seguridad.

Ref.	Código	Tipo	€/100
810800	7000011	Impulsor verde 6,8 x 11	39,13
810802	7000034	Impulsor rojo 6,8 x 11	39,13





Accesorios para PRO-06 GAS. Arandela plástica

Arandela plástica

Ref.	Código	Características	Ø mm	€/100
810780	401020	Para fijación de canaletas y cajas de distribución eléctrica Fijación con pistola de gas	20	30,43



Grapa ciega metálica

Ref.	Código	Características	Ø mm	€/100
810770	11003160	Grapa ciega metálica de una pata Acero cincado electrolítico Carga máxima de trabajo entre 25 daN y 40 daN Para fijación de todo tipo de tubos Fijación con pistola de gas	16	14,46
810771	11003182		18	17,65
810772	11003200		20	19,34
810773	11003221		22	22,06
810774	11003252		25	25,58
810775	11003258		28	29,89
810776	11003320	32	35,68	



Desa-multitube gas

Ref.	Código	Características	Color	Ø mm	€/100
810750	15060015	Abrazadera plástica con sistema de cierre de seguridad. Fijación con pistola de gas PRO-06 GAS. Rápida y fácil colocación. Para fijación de todo tipo de tubos	Gris	15-18	68,06
810751	15060020		Gris	20-25	81,19
810752	15060025		Gris	25-32	98,18



Clavo C8

Acero templado Ø 3,8 mm. Cincado blanco. Para herramientas: PRO-08, PRO-08 PLUS.

Ref.	Código	Longitud mm	€/100	Ref.	Código	Longitud mm	€/100
810900	1100016	16	15,38	810905	1100042	42	27,60
810907	1100019	19	16,73	810906	1100052	52	28,86
810901	1100022	22	17,33	810908	1100057	57	32,06
810902	1100027	27	18,11	810909	1100062	62	36,31
810903	1100032	32	20,37	810910	1100072	72	46,30
810904	1100037	37	22,80				



Clavo C-12 (1 arandela)

Acero templado Ø 3,8 mm, cabeza tonel. Arandela Ø 12 mm. Cincado blanco.

Ref.	Código	Longitud mm	€/100	Ref.	Código	Longitud mm	€/100
811600	2112220	22	20,82	811603	2112422	42	28,83
811601	2112275	27	22,33	811604	2112550	55	33,87
811602	2112321	32	23,64				



Clavo LM6-12

Acero templado Ø 3,8 mm, cabeza roscada M6 x 8. Arandela Ø 12 mm. Cincado blanco.

Ref.	Código	Longitud mm	€/100	Ref.	Código	Longitud mm	€/100
811500	1412125	12	44,45	811503	1412279	27	47,56
811501	1412171	17	45,34	811504	1412323	32	50,45
811502	1412224	22	46,21	811505	1412400	40	54,85



Clavo LM6-8



Acero templado Ø 3,8 mm, cabeza roscada M6 x 8. Arandela Ø 12 mm.
Cincado blanco.

Ref.	Código	Longitud mm	€/100
811400	1408121	12	43,35
811402	1408220	22	44,68
811403	1408275	27	48,00



Clavo suspensión techo ST-C8



Pieza para colgar varilla.

Ref.	Código	Longitud mm	€/100
811300	6100032	32	71,31



Clavo C8 + arandela metálica



Clavado de material blando sobre hormigón.

Ref.	Código	Longitud mm	Ø Arandela mm	€/100
811202	1100352	52	20	43,70
811200	1100272	27	25	36,55
811201	1100283	37	25	38,49
811203	1100274	27	35	56,34
811204	1100290	37	35	61,40



Clavo C8 + arandela plástica



Clavado de material blando sobre hormigón.

Ref.	Código	Longitud mm	Ø Arandela mm	€/100
811100	1303037	34	35	52,47
811101	1303047	47	35	60,73
811102	1303237	37	60	84,95



Punta cabeza plana CPL



Punta de acero templado para clavado sobre hormigón. UNE I7022-B1. Acero cincado y punta de diamante (4 caras piramidales). Clavado aproximado 20% de longitud sobre hormigón de 200 kg/cm² máximo. Para clavar maderas en hormigón.

Ref.	Código	Clavado en hormigón mm	Dimen. mm	Espesor madera mm	Longitud mm	Ø mm	€/100
812040	60501515	5	1,5x15	10	15	1,5	0,75
812041	60501525	10	1,5x25	15	25	1,5	1,10
812056	60502330	8	2,25x30	12	30	2,25	2,17
812042	60502520	8	2,5x20	12	20	2,5	1,62
812043	60502525	10	2,5x25	15	25	2,5	1,88
812044	60502530	10	2,5x30	20	30	2,5	2,17
812057	60502540	10	2,5x40	20	40	2,5	3,76
812058	60502550	10	2,5x50	20	50	2,5	4,87
812059	60502730	15	2,7x30	35	30	2,7	4,07
812046	60503040	12	3x40	28	40	3	3,82



Ref.	Código	Clavado en hormigón mm	Dimen. mm	Espesor madera mm	Longitud mm	Ø mm	€/100
812047	60503050	15	3x50	35	50	3	4,44
812048	60503060	15	3x60	45	60	3	5,66
812049	60503070	20	3x70	50	70	3	6,70
812050	60503530	10	3,5x30	20	30	3,5	3,61
812051	60503540	12	3,5x40	28	40	3,5	3,93
812052	60503550	15	3,5x50	35	50	3,5	5,40
812053	60503560	15	3,5x60	45	60	3,5	5,78
812054	60503570	20	3,5x70	50	70	3,5	6,95
812055	60503580	20	3,5x80	60	80	3,5	9,53

Clavo FT-VR C12



Acero templado Ø 3,8 mm. Cincado blanco. Para colgar varilla ROSCADA de M6.



Ref.	Código	Longitud mm	€/100
812000	6100108	32	151,21

Clavo CE (2 arandelas)



Acero templado Ø 3,8 mm, cabeza tonel. Arandela Ø 12 mm. Cincado blanco. Para clavado en estructuras de acero.



Ref.	Código	Longitud mm	€/100
811900	2312167	16	28,94
811901	2312192	19	29,53

Clavo CE (1 arandela)



Acero templado Ø 3,8 mm, cabeza tonel. Arandela Ø 12 mm. Cincado blanco.



Ref.	Código	Descripción	Longitud mm	€/100
811800	2312166	Para clavado en estructuras de acero.	16	22,48
811801	2312190	Para clavado en estructuras de acero.	19	23,71

Clavo C-12 (2 arandelas)



Acero templado Ø 3,8 mm, cabeza tonel. Arandela Ø 12 mm. Cincado blanco.



Ref.	Código	Longitud mm	€/100
811700	2212221	22	28,77
811701	2212276	27	29,76
811702	2212320	32	31,00

Ref.	Código	Longitud mm	€/100
811703	2212421	42	34,09
811704	2212551	55	39,68

Punta cabeza plana reforzada



Punta reforzada de acero templado para clavado sobre hormigón. Cabeza de superficie moleteada y reforzada: punta ojiva. Clavado aproximado 25% de longitud sobre hormigón de 250 kg/cm2 máximo. Para clavar maderas en hormigón. Acero cincado.



Ref.	Código	Clavado en hormigón mm	Dimen. mm	Espesor madera mm	Longitud mm	Ø mm	€/100
812060	60003440	15	3,5x40	25	40	3,5	4,71
812061	60003450	18	3,5x50	32	50	3,5	6,20

Ref.	Código	Clavado en hormigón mm	Dimen. mm	Espesor madera mm	Longitud mm	Ø mm	€/100
812062	60003460	18	3,5x60	42	60	3,5	6,95
812063	60003470	22	3,5x70	48	70	3,5	7,99

Aluminio/Acero remache estándar. Cabeza alomada UNE - EN ISO 15977



CABEZA: Aluminio Al Mg 3,5. VÁSTAGO: Acero protección cincado 3 μ.

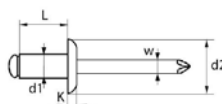

Ref.	Código	d1 Ø mm	d2 Ø mm	Rango de espesor mm	Diámetro del taladro mm	k mm	Longitud mm	W Ø mm	€/1.000
800261	10100048352	4,8	9,50	27,0 - 30,0	4,90	1,50	35	2,65	117,70
800210	1010002404	2,4	5,00	0,5 - 2,0	2,50	0,60	4	1,45	31,50
800211	1010002406	2,4	5,00	2,0 - 4,0	2,50	0,60	6	1,45	35,80
800212	1010002408	2,4	5,00	4,0 - 6,0	2,50	0,60	8	1,45	37,70
800213	1010002410	2,4	5,00	6,0 - 8,0	2,50	0,60	10	1,45	39,10
800214	1010002412	2,4	5,00	8,0 - 9,5	2,50	0,60	12	1,45	42,90
800215	1010003004	3,0	6,00	0,5 - 1,5	3,10	1,00	4	1,80	26,80
800216	1010003005	3,0	6,00	1,5 - 2,5	3,10	1,00	5	1,80	27,00
800217	1010003006	3,0	6,00	1,5 - 3,5	3,10	1,00	6	1,80	28,00
800218	1010003007	3,0	6,00	1,5 - 4,5	3,10	1,00	7	1,80	29,60
800219	1010003008	3,0	6,00	3,5 - 5,0	3,10	1,00	8	1,80	31,60
800220	1010003009	3,0	6,00	4,5 - 6,0	3,10	1,00	9	1,80	31,60
800221	1010003010	3,0	6,00	5,0 - 7,0	3,10	1,00	10	1,80	32,10
800222	1010003012	3,0	6,00	7,0 - 9,0	3,10	1,00	12	1,80	37,10
800223	1010003014	3,0	6,00	9,0 - 11,0	3,10	1,00	14	1,80	43,60
800224	1010003016	3,0	6,00	11,0 - 13,0	3,10	1,00	16	1,80	46,10
800225	1010003018	3,0	6,00	13,0 - 15,0	3,10	1,00	18	1,80	56,20
800226	1010003204	3,2	6,40	0,5 - 1,5	3,30	1,00	4	1,80	26,80
800227	1010003205	3,2	6,40	1,5 - 2,5	3,30	1,00	5	1,80	27,00
800228	1010003206	3,2	6,40	1,5 - 3,5	3,30	1,00	6	1,80	28,00
800229	1010003208	3,2	6,40	3,5 - 5,0	3,30	1,00	8	1,80	31,60
800230	1010003210	3,2	6,40	5,0 - 7,0	3,30	1,00	10	1,80	32,10
800231	1010003212	3,2	6,40	7,0 - 9,0	3,30	1,00	12	1,80	37,10
800232	1010003215	3,2	6,40	9,0 - 12,0	3,30	1,00	15	1,80	43,60
800233	1010003218	3,2	6,40	12,0 - 15,0	3,30	1,00	18	1,80	56,20
800234	1010003220	3,2	6,40	15,0 - 17,0	3,30	1,00	20	1,80	70,70
800235	1010004005	4,0	8,00	0,5 - 2,5	4,10	1,40	5	2,20	28,50
800236	1010004006	4,0	8,00	1,0 - 3,0	4,10	1,40	6	2,20	30,00
800237	1010004007	4,0	8,00	3,0 - 4,5	4,10	1,40	7	2,20	31,00
800238	1010004008	4,0	8,00	3,0 - 5,0	4,10	1,40	8	2,20	31,60
800239	1010004010	4,0	8,00	5,0 - 6,5	4,10	1,40	10	2,20	33,90
800240	1010004012	4,0	8,00	6,5 - 8,5	4,10	1,40	12	2,20	40,10
800241	1010004014	4,0	8,00	8,5 - 10,5	4,10	1,40	14	2,20	42,40
800242	1010004016	4,0	8,00	10,5 - 12,5	4,10	1,40	16	2,20	46,10
800243	1010004018	4,0	8,00	12,5 - 14,5	4,10	1,40	18	2,20	50,10
800244	1010004020	4,0	8,00	14,5 - 16,5	4,10	1,40	20	2,20	73,20
800245	1010004025	4,0	8,00	16,5 - 21,0	4,10	1,40	25	2,20	90,90
800246	1010004030	4,0	8,00	21,0 - 26,0	4,10	1,40	30	2,20	109,70
800247	1010004035	4,0	8,00	26,0 - 31,0	4,10	1,40	35	2,20	134,10
800248	1010004040	4,0	8,00	31,0 - 36,0	4,10	1,40	40	2,20	152,10
800249	1010004806	4,8	9,50	0,5 - 3,0	4,90	1,50	6	2,65	35,80
800250	1010004808	4,8	9,50	3,0 - 4,5	4,90	1,50	8	2,65	41,10
800251	1010004810	4,8	9,50	4,5 - 6,0	4,90	1,50	10	2,65	45,30
800252	1010004812	4,8	9,50	6,0 - 8,0	4,90	1,50	12	2,65	51,50
800253	1010004814	4,8	9,50	8,0 - 10,0	4,90	1,50	14	2,65	56,70

Ref.	Código	d1 Ø mm	d2 Ø mm	Rango de espesor mm	Diámetro del taladro mm	k mm	Longitud mm	W Ø mm	€/1.000
800254	1010004816	4,8	9,50	10,0 - 12,0	4,90	1,50	16	2,65	60,10
800255	1010004818	4,8	9,50	12,0 - 14,0	4,90	1,50	18	2,65	65,90
800256	1010004821	4,8	9,50	14,0 - 17,0	4,90	1,50	21	2,65	79,20
800257	1010004824	4,8	9,50	17,0 - 20,0	4,90	1,50	24	2,65	87,70
800258	1010004827	4,8	9,50	20,0 - 23,0	4,90	1,50	27	2,65	92,40
800259	1010004830	4,8	9,50	23,0 - 25,0	4,90	1,50	30	2,65	103,10
800260	1010004832	4,8	9,50	25,0 - 27,0	4,90	1,50	32	2,65	109,90
800262	1010004840	4,8	9,50	30,0 - 35,0	4,90	1,50	40	2,65	131,90
800263	1010004845	4,8	9,50	35,0 - 40,0	4,90	1,50	45	2,65	145,50
800264	1010004850	4,8	9,50	40,0 - 45,0	4,90	1,50	50	2,65	165,70
800265	1010005006	5,0	9,50	0,5 - 3,0	5,10	1,60	6	2,65	37,10
800266	1010005008	5,0	9,50	3,0 - 4,5	5,10	1,60	8	2,65	42,40
800267	1010005010	5,0	9,50	4,5 - 6,0	5,10	1,60	10	2,65	47,00
800268	1010005012	5,0	9,50	6,0 - 8,0	5,10	1,60	12	2,65	52,90
800269	1010005014	5,0	9,50	8,0 - 10,0	5,10	1,60	14	2,65	63,10
800270	1010005016	5,0	9,50	10,0 - 12,0	5,10	1,60	16	2,65	68,50
800271	1010005018	5,0	9,50	12,0 - 14,0	5,10	1,60	18	2,65	75,60
800272	1010005020	5,0	9,50	14,0 - 16,0	5,10	1,60	20	2,65	83,40
800273	1010005025	5,0	9,50	16,0 - 21,0	5,10	1,60	25	2,65	94,90
800274	1010005030	5,0	9,50	21,0 - 25,0	5,10	1,60	30	2,65	111,30
800275	1010005035	5,0	9,50	25,0 - 30,0	5,10	1,60	35	2,65	126,80
800276	1010005040	5,0	9,50	30,0 - 35,0	5,10	1,60	40	2,65	144,80
800277	1010005045	5,0	9,50	35,0 - 40,0	5,10	1,60	45	2,65	160,30
800278	1010005050	5,0	9,50	40,0 - 45,0	5,10	1,60	50	2,65	182,10
800279	1010006008	6,0	12,0	2,0 - 3,0	6,10	1,80	8	3,20	91,80
800280	1010006010	6,0	12,0	3,0 - 5,0	6,10	1,80	10	3,20	95,90
800281	1010006012	6,0	12,0	5,0 - 7,0	6,10	1,80	12	3,20	100,00
800282	1010006014	6,0	12,0	7,0 - 9,0	6,10	1,80	14	3,20	102,90
800283	1010006016	6,0	12,0	9,0 - 11,0	6,10	1,80	16	3,20	105,70
800284	1010006018	6,0	12,0	11,0 - 13,0	6,10	1,80	18	3,20	108,50
800285	1010006020	6,0	12,0	13,0 - 15,0	6,10	1,80	20	3,20	116,00
800286	1010006025	6,0	12,0	15,0 - 20,0	6,10	1,80	25	3,20	127,60
800287	1010006030	6,0	12,0	20,0 - 25,0	6,10	1,80	30	3,20	139,20
800288	1010006035	6,0	12,0	25,0 - 30,0	6,10	1,80	35	3,20	167,40
800289	1010006412	6,4	13,0	3,0 - 6,0	6,50	2,20	12	3,60	108,50
800290	1010006415	6,4	13,0	6,0 - 9,0	6,50	2,20	15	3,60	119,60
800291	1010006418	6,4	13,0	9,0 - 12,0	6,50	2,20	18	3,60	130,10
800292	1010006422	6,4	13,0	12,0 - 16,0	6,50	2,20	22	3,60	141,70
800293	1010006426	6,4	13,0	16,0 - 20,0	6,50	2,20	26	3,60	177,30
800294	1010006430	6,4	13,0	20,0 - 24,0	6,50	2,20	30	3,60	227,80
800295	1010006435	6,4	13,0	24,0 - 29,0	6,50	2,20	35	3,60	273,30
800296	1010006450	6,4	13,0	29,0 - 42,0	6,50	2,20	50	3,60	351,60
800297	G1010007815	7,8	13,5	6,0 - 9,0	8,00	2,20	15	3,60	151,30
800298	G1010007822	7,8	13,5	9,0 - 16,0	8,00	2,20	22	3,60	173,10

06



Aluminio/Acero remache estándar. Cabeza alomada



Ref.	Código	€/1.000	Ref.	Código	€/1.000	d1 Ø mm	Longitud mm
800115	01010BL2404	43,80	800150	01010N02404	43,80	2,4	4
			800151	01010N02406	46,30	2,4	6
800118	01010BL3206	37,20	800153	01010N03206	37,20	3,2	6
800119	01010BL3208	39,20	800154	01010N03208	39,20	3,2	8
800120	01010BL3210	41,60	800155	01010N03210	41,60	3,2	10
800121	01010BL3212	43,80	800156	01010N03212	43,80	3,2	12
800122	01010BL3215	53,30	800157	01010N03215	53,30	3,2	15
800123	01010BL3218	71,00	800158	01010N03218	71,00	3,2	18
800124	01010BL4006	44,90	800159	01010N04006	44,90	4,0	6
800126	01010BL4008	45,70	800161	01010N04008	45,70	4,0	8
800127	01010BL4010	49,10	800162	01010N04010	49,10	4,0	10
800128	01010BL4012	51,70	800163	01010N04012	51,70	4,0	12
800129	01010BL4014	54,70	800164	01010N04014	54,70	4,0	14
800130	01010BL4016	63,60	800165	01010N04016	63,60	4,0	16
800131	01010BL4018	70,10	800166	01010N04018	70,10	4,0	18

Ref.	Código	€/1.000	Ref.	Código	€/1.000	d1 Ø mm	Longitud mm
800132	01010BL4020	92,20	800167	01010N04020	92,20	4,0	20
800133	01010BL4025	109,30	800168	01010N04025	109,30	4,0	25
800134	01010BL4030	127,30	800169	01010N04030	127,30	4,0	30
800135	01010BL4806	54,30	800170	01010N04806	54,30	4,8	6
800136	01010BL4808	54,70	800171	01010N04808	54,70	4,8	8
800137	01010BL4810	59,30	800172	01010N04810	59,30	4,8	10
800138	01010BL4812	65,70	800173	01010N04812	65,70	4,8	12
800139	01010BL4814	70,90	800174	01010N04814	70,90	4,8	14
800140	01010BL4816	77,50	800175	01010N04816	77,50	4,8	16
800141	01010BL4818	87,70	800176	01010N04818	87,70	4,8	18
800142	01010BL4821	100,00	800177	01010N04821	100,00	4,8	21
800143	01010BL4824	114,20	800178	01010N04824	114,20	4,8	24
800144	01010BL4827	121,30	800179	01010N04827	121,30	4,8	27
800145	01010BL4830	129,90	800180	01010N04830	129,90	4,8	30
			800182	01010N04840	189,10	4,8	40

Aluminio/Acero remache estándar. Cabeza ancha



CABEZA: Aluminio Al Mg 3,5. VÁSTAGO: Acero protección cincado 3 µ.

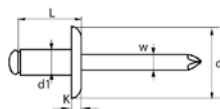

Ref.	Código	d1 Ø mm	d2 Ø mm	Rango de espesor mm	Diámetro del taladro mm	k mm	Longitud mm	W Ø mm	€/1.000
800315	1030003206	3,2	9,50	0,5 - 3,5	3,30	1,10	6	1,80	46,20
800316	1030003208	3,2	9,50	3,5 - 5,0	3,30	1,10	8	1,80	51,10
800317	1030003210	3,2	9,50	5,0 - 7,0	3,30	1,10	10	1,80	58,10
800318	1030003212	3,2	9,50	7,0 - 9,0	3,30	1,10	12	1,80	63,40
800319	1030003216	3,2	9,50	9,0 - 13,0	3,30	1,10	16	1,80	69,30
800320	1040004008	4,0	12,00	3,0 - 5,0	4,10	1,40	8	2,20	49,80
800321	1040004010	4,0	12,00	5,0 - 6,5	4,10	1,40	10	2,20	53,70
800322	1040004012	4,0	12,00	6,5 - 8,5	4,10	1,40	12	2,20	65,70
800323	1040004014	4,0	12,00	8,5 - 10,5	4,10	1,40	14	2,20	75,80
800324	1040004016	4,0	12,00	10,5 - 12,5	4,10	1,40	16	2,20	77,60
800325	1040004018	4,0	12,00	12,5 - 14,5	4,10	1,40	18	2,20	82,60
800326	1040004020	4,0	12,00	14,5 - 16,5	4,10	1,40	20	2,20	92,00
800327	1040004810	4,8	14,00	4,5 - 6,0	4,90	1,80	10	2,65	68,90
800328	1040004812	4,8	14,00	6,0 - 8,0	4,90	1,80	12	2,65	77,60
800329	1040004814	4,8	14,00	8,0 - 10,0	4,90	1,80	14	2,65	93,20
800330	1040004816	4,8	14,00	10,0 - 12,0	4,90	1,80	16	2,65	100,20
800331	1040004818	4,8	14,00	12,0 - 14,0	4,90	1,80	18	2,65	111,10
800332	1040004821	4,8	14,00	14,0 - 17,0	4,90	1,80	21	2,65	124,80
800333	1040004824	4,8	14,00	17,0 - 20,0	4,90	1,80	24	2,65	137,30
800334	1040004827	4,8	14,00	20,0 - 23,0	4,90	1,80	27	2,65	149,70
800335	1040004830	4,8	14,00	23,0 - 25,0	4,90	1,80	30	2,65	165,00
800336	1040004835	4,8	14,00	25,0 - 30,0	4,90	1,80	35	2,65	218,60
800337	1030004810	4,8	14,00	30,0 - 35,0	4,90	1,80	40	2,65	62,50
800338	1030004812	4,8	14,00	35,0 - 40,0	4,90	1,80	45	2,65	70,40
800339	1030004814	4,8	14,00	40,0 - 45,0	4,90	1,80	50	2,65	84,60
800340	1030004816	4,8	16,00	4,5 - 6,0	4,90	1,80	10	2,65	91,30
800341	1030004818	4,8	16,00	6,0 - 8,0	4,90	1,80	12	2,65	101,20
800342	1030004821	4,8	16,00	8,0 - 10,0	4,90	1,80	14	2,65	114,80

Ref.	Código	d1 Ø mm	d2 Ø mm	Rango de espesor mm	Diámetro del taladro mm	k mm	Longitud mm	W Ø mm	€/1.000
800343	1030004824	4,8	16,00	10,0 - 12,0	4,90	1,80	16	2,65	127,60
800344	1030004827	4,8	16,00	12,0 - 14,0	4,90	1,80	18	2,65	135,70
800345	1030004830	4,8	16,00	14,0 - 17,0	4,90	1,80	21	2,65	150,00
800346	1030004835	4,8	16,00	17,0 - 20,0	4,90	1,80	24	2,65	198,30
800347	1030004840	4,8	16,00	20,0 - 23,0	4,90	1,80	27	2,65	221,50
800348	1030004845	4,8	16,00	23,0 - 25,0	4,90	1,80	30	2,65	272,10
800349	1030004850	4,8	16,00	25,0 - 30,0	4,90	1,80	35	2,65	324,40
800350	1031005008	5,0	11,00	3,0 - 4,5	5,10	1,60	8	2,65	59,30
800351	1031005010	5,0	11,00	4,5 - 6,0	5,10	1,60	10	2,65	65,20
800352	1031005012	5,0	11,00	6,0 - 8,0	5,10	1,60	12	2,65	73,10
800353	1031005014	5,0	11,00	8,0 - 10,0	5,10	1,60	14	2,65	88,70
800354	1031005016	5,0	11,00	10,0 - 12,0	5,10	1,60	16	2,65	95,50
800355	1031005018	5,0	11,00	12,0 - 14,0	5,10	1,60	18	2,65	105,80
800356	1031005020	5,0	11,00	14,0 - 16,0	5,10	1,60	20	2,65	115,40
800357	1031005025	5,0	11,00	16,0 - 21,0	5,10	1,60	25	2,65	131,10
800358	1031005030	5,0	11,00	21,0 - 25,0	5,10	1,60	30	2,65	155,60
800359	1030005008	5,0	14,00	3,0 - 4,5	5,10	1,80	8	2,65	52,40
800360	1030005010	5,0	14,00	4,5 - 6,0	5,10	1,80	10	2,65	56,30
800361	1030005012	5,0	14,00	6,0 - 8,0	5,10	1,80	12	2,65	63,90
800362	1030005014	5,0	14,00	8,0 - 10,0	5,10	1,80	14	2,65	76,10
800363	1030005016	5,0	14,00	10,0 - 12,0	5,10	1,80	16	2,65	82,60
800364	1030005018	5,0	14,00	12,0 - 14,0	5,10	1,80	18	2,65	90,50
800365	1030005020	5,0	14,00	14,0 - 16,0	5,10	1,80	20	2,65	100,80
800366	1030005025	5,0	14,00	16,0 - 21,0	5,10	1,80	25	2,65	114,70
800367	1030005030	5,0	14,00	21,0 - 25,0	5,10	1,80	30	2,65	134,80
21023009	G1035006410	6,4	10	2,0-4,0	6,5	2	10	3,6	114,40
21023010	G1035006412	6,4	12,00	3,0-6,0	6,5	2	12	3,6	121,50

Remache flor



Elemento de fijación de aleación de aluminio con una gran superficie posterior de apoyo en forma de flor con cuatro patillas o pétalos. El remache Flor es ideal para aplicaciones sobre materiales plásticos o de baja resistencia. El remache Flor Bralo está disponible en una infinidad de lacados con pintura epóxica. Del blanco al negro, contamos con una paleta de más de 100 colores según RAL y podemos realizar también lacados especiales bajo petición.



Ref.	Código	d1 Ø mm	Longitud mm	€/1.000
800415	01130N04008	4,0	8	61,50
800416	01130N04010	4,0	10	64,20
800417	01130N04012	4,0	12	71,70
800418	01130N04014	4,0	14	75,30
800419	01130N04016	4,0	16	85,00
800420	01130N04018	4,0	18	92,40
800421	01130N04020	4,0	20	106,00
21023011	01130N04025	4,0	25	114,40
800422	01130N04810	4,8	10	76,60

Ref.	Código	d1 Ø mm	Longitud mm	€/1.000
800423	01130N04812	4,8	12	82,90
800424	01130N04814	4,8	14	93,00
800425	01130N04816	4,8	16	98,20
800426	01130N04818	4,8	18	105,30
800427	01130N04821	4,8	21	116,30
800428	01130N04824	4,8	24	125,60
800429	01130N04827	4,8	27	145,00
800430	01130N04830	4,8	30	156,60

Aluminio/Acero remache flor. Cabeza alomada



CABEZA: Aluminio Al Mg 3,5. VÁSTAGO: Acero protección cincado 3 µ.

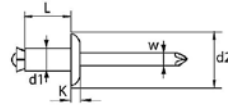

Ref.	Código	d1 Ø mm	d2 Ø mm	Rango de espesor mm	Diámetro del taladro mm	k mm	Longitud mm	W Ø mm	€/1.000
800510	1130003208	3,2	6,50	3,5	3,40	0,80	8	1,80	42,70
800511	1130003210	3,2	6,50	5,0	3,40	0,80	10	1,80	55,20
800512	1130003212	3,2	6,50	7,0	3,40	0,80	12	1,80	64,90
800513	1130003214	3,2	6,50	9,0	3,40	0,80	14	1,80	73,10
800514	1130003216	3,2	6,50	11,0	3,40	0,80	16	1,80	83,00
800515	1130003218	3,2	6,50	13,0	3,40	0,80	18	1,80	91,90
800516	1130004008	4,0	8,00	4,0	4,20	1,00	8	2,20	42,70
800517	1130004010	4,0	8,00	6,0	4,20	1,00	10	2,20	46,70
800518	1130004012	4,0	8,00	8,0	4,20	1,00	12	2,20	55,80
800519	1130004014	4,0	8,00	10,0	4,20	1,00	14	2,20	60,50
800520	1130004016	4,0	8,00	12,0	4,20	1,00	16	2,20	68,40
800521	1130004018	4,0	8,00	14,0	4,20	1,00	18	2,20	78,90
800522	1130004020	4,0	8,00	16,0	4,20	1,00	20	2,20	95,90
800523	1130004025	4,0	8,00	21,0	4,20	1,00	25	2,20	112,30
800524	1130004810	4,8	9,50	5,0	5,00	1,10	10	2,73	58,80
800525	1130004812	4,8	9,50	7,0	5,00	1,10	12	2,73	66,80
800526	1130004814	4,8	9,50	9,0	5,00	1,10	14	2,73	79,30
800527	1130004816	4,8	9,50	11,0	5,00	1,10	16	2,73	86,20
800528	1130004818	4,8	9,50	13,0	5,00	1,10	18	2,73	95,00
800529	1130004821	4,8	9,50	16,0	5,00	1,10	21	2,73	108,40
800530	1130004824	4,8	9,50	19,0	5,00	1,10	24	2,73	120,40
800531	1130004827	4,8	9,50	22,0	5,00	1,10	27	2,73	128,50
800532	1130004830	4,8	9,50	25,0	5,00	1,10	30	2,73	141,60
800533	1130004832	4,8	9,50	27,0	5,00	1,10	32	2,73	142,00
800535	1130004840	4,8	9,50	32,0	5,00	1,10	40	2,73	177,40
800536	1130004845	4,8	9,50	37,0	5,00	1,10	45	2,73	189,40
800537	1130004850	4,8	9,50	42,0	5,00	1,10	50	2,73	229,50
800538	1130005040	5,0*	9,30	32,0	5,20	1,50	40	2,73	234,20

Ref.	Código	d1 Ø mm	d2 Ø mm	Rango de espesor mm	Diámetro del taladro mm	k mm	Longitud mm	W Ø mm	€/1.000
800539	1130005045	5,0*	9,30	37,0	5,20	1,50	45	2,73	252,10
800540	1130005050	5,0*	9,30	42,0	5,20	1,50	50	2,73	303,90
800541	1130005055	5,0*	9,30	47,0	5,20	1,50	55	2,73	324,80
800542	G1130005060	5,0*	9,30	52,0	5,20	1,50	60	2,73	355,70
800543	G1130005065	5,0*	9,30	57,0	5,20	1,50	65	2,73	376,80
800544	G1130005070	5,0*	9,30	62,0	5,20	1,50	70	2,73	417,70
800545	G1130005075	5,0*	9,30	68,0	5,20	1,50	75	2,73	455,10
800546	G1130005080	5,0*	9,30	72,0	5,20	1,50	80	2,73	479,50
800547	G1130005090	5,0*	9,30	80,0	5,20	1,50	90	2,73	696,00
800548	G11300050100	5,0*	9,30	90,0	5,20	1,50	100	2,73	807,50
800549	G11300050110	5,0*	9,30	100,0	5,20	1,50	110	2,73	921,60
800550	G11300050120	5,0*	9,30	110,0	5,20	1,50	120	2,73	1.040,50
800551	G11300050130	5,0*	9,30	120,0	5,20	1,50	130	2,73	1.126,40
800552	G11300050140	5,0*	9,30	130,0	5,20	1,50	140	2,73	1.263,50
800553	G11300050150	5,0*	9,30	140,0	5,20	1,50	150	2,73	1.373,80
800554	G11300050160	5,0*	9,30	150,0	5,20	1,50	160	2,73	1.476,20
800555	G11300050170	5,0*	9,30	160,0	5,20	1,50	170	2,73	1.594,30
800556	G11300050180	5,0*	9,30	170,0	5,20	1,50	180	2,73	1.704,80
800557	G11300050190	5,0*	9,30	180,0	5,20	1,50	190	2,73	1.815,50
800558	1130006435	6,4*	13,00	25,0	6,60	2,00	35	3,50	388,70
800559	G1130006450	6,4*	13,00	40,0	6,60	2,00	50	3,50	516,20
800560	G1130006480	6,4*	13,00	70,0	6,60	2,00	80	3,50	525,30
800561	G11300064100	6,4*	13,00	90,0	6,60	2,00	100	3,50	1.052,10
800562	G11300064120	6,4*	13,00	110,0	6,60	2,00	120	3,50	1.253,50
800563	G11300064150	6,4*	13,00	140,0	6,60	2,00	150	3,50	1.549,30
800564	G11300064175	6,4*	13,00	165,0	6,60	2,00	175	3,50	1.789,40
800565	G11300064200	6,4*	13,00	180,0	6,60	2,00	190	3,50	1.876,00

06



Inox A2/Inox A2 remache estándar. Cabeza ancha



CABEZA: Inox 304. VÁSTAGO: Inox 304.

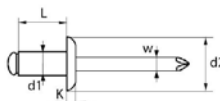

Ref. INOX	Código INOX	d1 Ø mm	d2 Ø mm	Rango de espesor mm	Diámetro del taladro mm	k mm	Longitud mm	W Ø mm	€/1.000
800383	11300048352	4,8	16,00	16,0 - 19,0	4,90	2,20	25	3,10	145,60
800370	1310003210	3,2	9,50	5,0 - 6,5	3,30	1,40	10	2,10	178,00
800371	1310004010	4,0	12,00	4,5 - 6,5	4,10	1,80	10	2,40	257,80
800372	1310004013	4,0	12,00	6,5 - 9,5	4,10	1,80	13	2,40	272,80
800373	1310004016	4,0	12,00	9,5 - 12,0	4,10	1,80	16	2,40	371,30
800374	1311004808	4,8	14,00	2,0 - 4,0	4,90	2,20	8	3,10	314,00
800375	1310004808	4,8	16,00	2,0 - 4,0	4,90	2,20	8	3,10	323,40
800376	1310004810	4,8	16,00	4,0 - 6,0	4,90	2,20	10	3,10	355,70

Ref. INOX	Código INOX	d1 Ø mm	d2 Ø mm	Rango de espesor mm	Diámetro del taladro mm	k mm	Longitud mm	W Ø mm	€/1.000
800377	1310004812	4,8	16,00	6,0 - 8,0	4,90	2,20	12	3,10	397,40
800378	1310004814	4,8	16,00	8,0 - 10,0	4,90	2,20	14	3,10	425,40
800379	1310004816	4,8	16,00	9,5 - 11,0	4,90	2,20	16	3,10	433,20
800380	1310004818	4,8	16,00	11,0 - 13,0	4,90	2,20	18	3,10	463,70
800381	1310004820	4,8	16,00	13,0 - 16,0	4,90	2,20	20	3,10	502,80
800382	1310004822	4,8	16,00	16,0 - 18,0	4,90	2,20	22	3,10	542,60
800385	1310004835	4,8	16,00	24,0 - 29,0	4,90	2,20	35	3,10	676,50

Inox remache estándar. Cabeza alomada UNE - EN ISO 15983



CABEZA: Inox 304. VÁSTAGO: Inox 304.

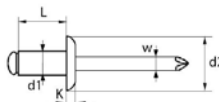

Ref. INOX	Código INOX	d1 Ø mm	d2 Ø mm	Rango de espesor mm	Diámetro del taladro mm	k mm	Longitud mm	W Ø mm	€/1.000
800610	1260002406	2,4	5,00	2,0 - 3,5	2,50	0,60	6	1,50	110,30
800611	1260002408	2,4	5,00	3,5 - 5,5	2,50	0,60	8	1,50	112,90
800612	1260002410	2,4	5,00	5,5 - 7,5	2,50	0,60	10	1,50	116,50
800613	1260002412	2,4	5,00	7,5 - 9,5	2,50	0,60	12	1,50	119,30
800614	1260003005	3,0	6,00	0,5 - 2,5	3,10	1,00	5	2,00	102,70
800615	1260003006	3,0	6,00	0,5 - 3,0	3,10	1,00	6	2,00	110,10
800616	1260003008	3,0	6,00	3,0 - 5,0	3,10	1,00	8	2,00	121,90
800617	1260003010	3,0	6,00	5,0 - 6,5	3,10	1,00	10	2,00	128,70
800618	1260003012	3,0	6,00	6,5 - 8,5	3,10	1,00	12	2,00	149,60
800619	1260003014	3,0	6,00	8,5 - 10,5	3,10	1,00	14	2,00	203,00
800620	1260003206	3,2	6,40	0,5 - 3,0	3,30	1,00	6	2,10	110,10
800621	1260003208	3,2	6,40	3,0 - 5,0	3,30	1,00	8	2,10	121,90
800622	1260003210	3,2	6,40	5,0 - 6,5	3,30	1,00	10	2,10	128,70
800623	1260003212	3,2	6,40	6,5 - 8,5	3,30	1,00	12	2,10	149,60
800624	1260003215	3,2	6,40	8,5 - 12,0	3,30	1,00	15	2,10	206,00
800625	1260003218	3,2	6,40	12,0 - 15,0	3,30	1,00	18	2,10	336,10
800626	1260004006	4,0	8,00	1,0 - 2,5	4,10	1,30	6	2,40	145,60
800627	1260004008	4,0	8,00	2,5 - 4,5	4,10	1,30	8	2,40	160,50
800628	1260004010	4,0	8,00	4,5 - 6,5	4,10	1,30	10	2,40	178,40
800629	1260004012	4,0	8,00	6,5 - 8,5	4,10	1,30	12	2,40	196,10
800630	1260004014	4,0	8,00	8,5 - 10,0	4,10	1,30	14	2,40	216,90
800631	1260004016	4,0	8,00	10,0 - 12,0	4,10	1,30	16	2,40	246,70
800632	1260004018	4,0	8,00	12,0 - 14,0	4,10	1,30	18	2,40	345,60
800633	1260004020	4,0	8,00	14,0 - 16,0	4,10	1,30	20	2,40	365,00
800634	1260004025	4,0	8,00	16,0 - 21,0	4,10	1,30	25	2,40	383,90
800635	1260004808	4,8	9,00	2,0 - 4,0	4,90	1,60	8	3,10	177,60

Ref. INOX	Código INOX	d1 Ø mm	d2 Ø mm	Rango de espesor mm	Diámetro del taladro mm	k mm	Longitud mm	W Ø mm	€/1.000
800636	1260004810	4,8	9,00	4,0 - 6,0	4,90	1,60	10	3,10	193,10
800637	1260004812	4,8	9,00	6,0 - 8,0	4,90	1,60	12	3,10	208,30
800638	1260004814	4,8	9,00	8,0 - 9,5	4,90	1,60	14	3,10	246,70
800639	1260004816	4,8	9,00	9,5 - 11,0	4,90	1,60	16	3,10	276,20
800640	1260004818	4,8	9,00	11,0 - 13,0	4,90	1,60	18	3,10	181,20
800641	1260004820	4,8	9,00	13,0 - 16,0	4,90	1,60	20	3,10	456,70
800642	1260004825	4,8	9,00	16,0 - 19,0	4,90	1,60	25	3,10	548,80
800643	1260004830	4,8	9,00	19,0 - 24,0	4,90	1,60	30	3,10	668,50
800644	1260004835	4,8	9,00	24,0 - 29,0	4,90	1,60	35	3,10	687,50
800645	1260004840	4,8	9,00	29,0 - 34,0	4,90	1,60	40	3,10	685,90
800646	1260005008	5,0	9,00	2,0 - 4,0	5,10	1,60	8	3,10	186,40
800647	1260005010	5,0	9,00	4,0 - 6,0	5,10	1,60	10	3,10	202,70
800648	1260005012	5,0	9,00	6,0 - 8,0	5,10	1,60	12	3,10	218,50
800649	1260005014	5,0	9,00	8,0 - 9,5	5,10	1,60	14	3,10	259,20
800650	1260005016	5,0	9,00	9,5 - 11,0	5,10	1,60	16	3,10	290,00
800651	1260005020	5,0	9,00	13,0 - 16,0	5,10	1,60	20	3,10	460,90
800652	1260005025	5,0	9,00	16,0 - 19,0	5,10	1,60	25	3,10	550,20
800653	1260005030	5,0	9,00	19,0 - 24,0	5,10	1,60	30	3,10	678,60
800654	1260005035	5,0	9,00	24,0 - 29,0	5,10	1,60	35	3,10	686,80
800655	1260005040	5,0	9,00	29,0 - 34,0	5,10	1,60	40	3,10	715,80
800656	1260006412	6,4	12,50	2,0 - 6,0	6,50	2,20	12	3,85	365,80
800657	1260006415	6,4	12,50	6,0 - 9,0	6,50	2,20	15	3,85	439,30
800658	1260006418	6,4	12,50	9,0 - 12,0	6,50	2,20	18	3,85	475,10
800659	1260006420	6,4	12,50	12,0 - 14,0	6,50	2,20	20	3,85	510,90
800660	1260006425	6,4	12,50	14,0 - 18,0	6,50	2,20	25	3,85	600,30

Inox A2/Inox A2 remache estándar. Cabeza avellanada 120° UNE - EN ISO 15984



CABEZA: Inox 304. VÁSTAGO: Inox 304.

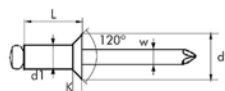

Ref. INOX	Código INOX	d1 Ø mm	d2 Ø mm	Rango de espesor mm	Diámetro del taladro mm	k mm	Longitud mm	W Ø mm	€/1.000
800450	1270003206	3,2	6,30	1,5 - 3,0	3,30	1,00	6	2,10	142,40
800451	1270003208	3,2	6,30	3,0 - 5,0	3,30	1,00	8	2,10	150,90
800452	1270003210	3,2	6,30	5,0 - 6,5	3,30	1,00	10	2,10	170,50
800453	1270003212	3,2	6,30	6,5 - 8,5	3,30	1,00	12	2,10	183,30
800454	1270004008	4,0	7,60	2,5 - 4,5	4,10	1,30	8	2,40	215,10
800455	1270004010	4,0	7,60	4,5 - 6,5	4,10	1,30	10	2,40	230,70
800456	1270004012	4,0	7,60	6,5 - 8,5	4,10	1,30	12	2,40	264,30

Ref. INOX	Código INOX	d1 Ø mm	d2 Ø mm	Rango de espesor mm	Diámetro del taladro mm	k mm	Longitud mm	W Ø mm	€/1.000
800457	1270004014	4,0	7,60	8,5 - 10,0	4,10	1,30	14	2,40	282,30
800458	1270004808	4,8	9,50	2,5 - 4,0	4,90	1,40	8	3,10	276,60
800459	1270004810	4,8	9,50	4,0 - 6,0	4,90	1,40	10	3,10	301,60
800460	1270004812	4,8	9,50	6,0 - 8,0	4,90	1,40	12	3,10	327,90
800461	1270004814	4,8	9,50	8,0 - 10,0	4,90	1,40	14	3,10	355,80
800462	1270004818	4,8	9,50	12,0 - 14,0	4,90	1,40	18	3,10	499,70

Acero tuerca lisa. Cabeza ancha. Fondo abierto



Acero protección cincado 8 µ.

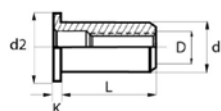

Ref.	Código	D mm	Longitud mm	d1 Ø mm	d2 Ø mm	K mm	Diámetro del taladro mm	Rango de espesor mm	€/1.000
800465	301104006	M 4	9,5	5,9	9	1	6,1	0,5 - 2,0	92,60
800466	301114006	M 4	12,25	5,9	9	1	6,1	2,0 - 4,0	98,70
800467	301105007	M 5	12	6,9	10	1	7,1	0,5 - 3,0	112,60
800468	301115007	M 5	15	6,9	10	1	7,1	3,0 - 5,5	125,70
800469	301185007	M 5	18	6,9	10	1	7,1	5,5 - 8,0	140,20
800470	301106009	M 6	14,5	8,9	13	1,5	9,1	0,5 - 3,0	124,10
800471	301116009	M 6	16,5	8,9	13	1,5	9,1	3,0 - 5,5	155,50

Ref.	Código	D mm	Longitud mm	d1 Ø mm	d2 Ø mm	K mm	Diámetro del taladro mm	Rango de espesor mm	€/1.000
800472	301186009	M 6	21,5	8,9	13	1,5	9,1	5,5 - 8,0	189,40
800473	301108011	M 8	16,5	8,9	13	1,5	9,1	0,5 - 3,0	175,40
800474	301118011	M 8	18,5	10,9	16	1,5	11,1	3,0 - 5,5	196,00
800475	301188011	M 8	22,5	10,9	16	1,5	11,1	5,5 - 8,0	226,20
800476	301108011	M 8	25,5	10,9	16	1,5	11,1	8,0 - 10,5	424,60
800477	301101012	M 10	17,5	11,9	16	1,7	12,1	1,0 - 3,5	285,00
800481	G301101216	M 12	25	15,9	23	2	16,1	1,0 - 4,0	543,10

Acero tuerca ranurada. Cabeza ancha. Fondo abierto



Acero protección cincado 8 µ.

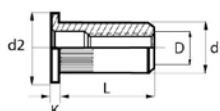

Ref.	Código	d	d1 Ø mm	d2 Ø mm	Rango de espesor mm	Diámetro del taladro mm	k mm	Longitud mm	€/1.000
800485	371103005	M 3	4,90	8,00	0,25 - 2,5	5,10	1,00	10,50	102,00
800486	371104006	M 4	5,90	9,00	0,5 - 2,0	6,10	1,00	9,50	97,30
800487	371114006	M 4	5,90	9,00	2,0 - 4,5	6,10	1,00	12,25	103,10
800488	371105007	M 5	6,90	10,00	0,5 - 3,0	7,10	1,00	12,00	116,50
800489	371115007	M 5	6,90	10,00	3,0 - 5,5	7,10	1,00	15,00	131,50
800490	371106009	M 6	8,90	13,00	0,5 - 3,0	9,10	1,50	14,50	136,30
800491	371116009	M 6	8,90	13,00	3,0 - 5,5	9,10	1,50	16,50	165,30

Ref.	Código	d	d1 Ø mm	d2 Ø mm	Rango de espesor mm	Diámetro del taladro mm	k mm	Longitud mm	€/1.000
800493	371108011	M 8	10,90	16,00	0,5 - 3,0	11,10	1,50	16,50	199,10
800494	371118011	M 8	10,90	16,00	3,0 - 5,5	11,10	1,50	18,50	218,40
800495	371101013	M 10	12,90	19,00	1,0 - 3,5	13,10	2,00	19,50	330,20
800496	371110103	M 10	12,90	19,00	3,5 - 6,0	13,10	2,00	21,50	349,40
800497	G371121013	M 10	12,90	19,00	2,4 - 4,0	13,10	2,00	19,50	330,20
800498	G371101216	M 12	15,90	23,00	1,0 - 4,0	16,10	2,00	25,00	554,10



Acero tuerca lisa. Cabeza baja. Fondo abierto. Pulgadas

Acero protección cincado 8 µ.



Pulgadas

Ref.	Código	D mm	Longitud mm	d1 Ø mm	d2 Ø mm	Diámetro del taladro mm	Rango de espesor mm	€/1.000
800190	301203005	M 3	8,7	4,65	5,4	5,1	0,5 - 1,5	134,40
800191	301204006	M 4	10,4	6,3	6,7	6,4	0,5 - 2,0	93,00
800192	301205007	M 5	11,5	7,1	7,9	7,2	0,5 - 3,0	103,30
800193	301206009	M 6	14,5	9,5	10,6	9,6	0,5 - 3,0	124,20
800194	301208011	M 8	16	10,5	11,6	10,6	0,5 - 3,0	154,80
21023007	301201013	M 10	21	12,95		13,10	0,7 - 3,5	330,10

Milímetros

Ref.	Código	D mm	Longitud mm	d1 Ø mm	d2 Ø mm	Diámetro del taladro mm	Rango de espesor mm	€/100
800195	301204005	M 4	10	5,9	7	6	0,5 - 2,0	119,10
800196	301205006	M 5	12	6,9	8	7	0,5 - 3,0	129,80
800197	301206008	M 6	15	8,9	10	9	0,5 - 3,0	168,80
800198	301208010	M 8	16	10,9	12	11	0,5 - 3,0	254,10

Acero tuerca ranurada. Cabeza baja. Fondo abierto



Acero protección cincado 8 µ.



Ref.	Código	d	d1 Ø mm	d2 Ø mm	Rango de espesor mm	Diámetro del taladro mm	Longitud mm	€/1.000
800390	371204006	M 4	5,90	7,00	0,5 - 2,0	6,10	10,40	113,70
800391	371205007	M 5	6,90	8,00	0,5 - 3,0	7,10	11,50	124,20
800392	371206009	M 6	8,90	10,00	0,5 - 3,0	9,10	14,50	133,70
800393	371216009	M 6	8,90	10,00	3,0 - 5,5	9,10	16,50	166,00
800394	371208011	M 8	10,90	12,00	0,5 - 3,0	11,10	16,80	195,30

Ref.	Código	d	d1 Ø mm	d2 Ø mm	Rango de espesor mm	Diámetro del taladro mm	Longitud mm	€/1.000
800395	371218011	M 8	10,90	12,00	3,0 - 5,5	11,10	18,50	212,80
800396	371201013	M 10	12,90	14,00	0,7 - 3,5	13,10	21,00	330,10
800397	G371211013	M 10	12,90	14,00	3,0 - 5,5	13,10	23,50	346,90
800398	G371201216	M 12	15,90	17,00	1,0 - 3,5	16,10	24,20	521,90

Acero tuerca ranurada. Cabeza avellanada. Fondo abierto



Acero protección cincado 8 µ.



Ref.	Código	d	d1 Ø mm	d2 Ø mm	Rango de espesor mm	Diámetro del taladro mm	Longitud mm	€/1.000
800570	371304006	M 4	8,50	1,50	1,5 - 3,0	6,10	5,90	156,30
800571	371305007	M 5	10,00	1,50	1,5 - 4,0	7,10	6,90	161,10
800572	371306009	M 6	12,00	1,50	1,5 - 4,0	9,10	8,90	166,10

Ref.	Código	d	d1 Ø mm	d2 Ø mm	Rango de espesor mm	Diámetro del taladro mm	Longitud mm	€/1.000
800573	371308011	M 8	13,50	1,50	1,5 - 4,0	11,10	10,90	200,00
800574	371328011	M 8	13,50	1,50	2,0 - 4,5	11,10	10,90	218,40
800575	371301013	M 10	16,00	1,50	1,5 - 4,5	13,10	12,90	331,90

DIN 933 métrica

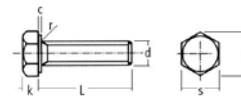

Ref. 8.8	€/100 8.8	Ref. 8.8 Zn	€/100 8.8 Zn	Ref. 10.9	€/100 10.9	Ref. A2	€/100 A2	Longitud mm
						501530	11,80	04x006
						501531	12,40	04x008
		501003	4,48			501532	13,40	04x010
		501004	4,92			501533	14,70	04x012
		501005	5,78			501534	17,16	04x016
		501006	6,58			501535	19,74	04x020
		501007	7,64			501536	22,88	04x025
		501008	8,68			501537	26,10	04x030
						501538	31,64	04x035
						501539	35,10	04x040
						501540	41,42	04x045
						501541	45,14	04x050
						501542	12,30	05x008
		501014	5,64			501543	12,90	05x010
		501015	6,14			501544	14,10	05x012
		501016	7,20			501545	16,56	05x016
		501017	8,32			501546	18,98	05x020
		501018	9,62			501547	22,02	05x025
		501019	10,92			501548	25,06	05x030
		501020	12,22			501549	28,08	05x035
		501021	13,66			501550	31,14	05x040
		501022	15,02			501551	34,30	05x045
		501023	16,52			501552	37,70	05x050
						501553	44,80	05x055
						501554	48,12	05x060
504932	7,98	501029	8,68			501558	20,60	06x010
504933	8,64	501030	9,44			501559	21,72	06x012
504935	9,56	501031	10,42			501560	24,76	06x016
504937	10,82	501033	11,86			501562	28,08	06x020
504938	12,46	501034	13,66			501563	32,18	06x025
504939	14,04	501035	15,36			501564	36,34	06x030
504940	15,58	501036	17,06			501565	40,48	06x035
504941	17,26	501037	18,86			501566	44,64	06x040
504942	18,86	501038	20,64			501567	48,86	06x045
504943	20,54	501039	22,46			501568	53,22	06x050
504944	22,20	501040	24,32			501569	58,42	06x055
504945	23,76	501041	26,00			501570	62,32	06x060
		501042	28,66			501571	68,58	06x065
504947	27,66	501043	30,40			501572	72,62	06x070
		501044	32,18			501573	79,28	06x075
504949	31,14	501045	34,12			501574	83,90	06x080
504950	34,60	501046	37,84			501575	98,12	06x090
504951	38,02	501047	41,68			501576	107,96	06x100
504971	16,18	501048	17,76			501577	44,20	08x010
504972	17,42	501049	19,04			501578	45,04	08x012
504974	19,78	501050	21,58	501314	28,74	501579	46,64	08x016
504975	21,90	501051	23,94	501315	31,80	501580	51,64	08x020
504977	24,70	501052	27,10	501316	35,96	501581	58,34	08x025
504979	27,58	501053	30,16	501317	40,06	501582	65,14	08x030
504980	30,40	501054	33,22	501318	44,20	501583	71,82	08x035
504981	33,18	501055	36,40	501319	48,36	501584	78,52	08x040
504982	36,12	501056	39,50	501320	52,46	501585	85,28	08x045
504983	38,74	501057	42,46	501321	56,36	501586	91,52	08x050
504984	41,62	501058	45,52			501587	98,28	08x055
504985	44,40	501059	48,68	501323	64,64	501588	104,98	08x060
504986	47,20	501060	51,80			501589	113,50	08x065
504987	50,10	501061	54,86			501590	120,30	08x070
504988	52,88	501062	57,98			501591	127,14	08x075
504989	55,74	501063	61,16			501592	133,96	08x080
504990	61,46	501064	67,36			501593	149,86	08x090
504992	66,98	501066	73,42			501595	168,22	08x100
504993	104,36	501067	107,70					08x110

Ref. 8.8	€/100 8.8	Ref. 8.8 Zn	€/100 8.8 Zn	Ref. 10.9	€/100 10.9	Ref. A2	€/100 A2	Longitud mm
504994	112,74	501068	116,22			501600	85,72	10x016
504997	34,12	501071	37,38			501601	93,22	10x020
504998	37,70	501072	41,24	501336	54,76	501602	104,18	10x025
504999	42,12	501073	46,08	501337	61,26	501604	115,24	10x030
505001	46,56	501075	51,04	501339	67,70	501605	126,20	10x035
505002	51,04	501076	55,82	501340	74,16	501606	137,18	10x040
505003	55,46	501077	60,72	501341	80,62	501607	148,14	10x045
505004	59,82	501078	65,62	501342	87,12	501608	159,20	10x050
505005	64,30	501079	70,48	501343	93,58	501609	170,14	10x055
505006	68,78	501080	75,30			501610	181,56	10x060
505007	73,42	501081	80,36	501345	106,80	501611	192,54	10x065
505008	77,82	501082	85,28			501612	203,58	10x070
505009	82,24	501083	90,16	501347	119,60	501613	214,56	10x075
505010	86,76	501084	95,00			501614	225,52	10x080
505011	91,16	501085	99,84	501349	132,60	501615	236,46	10x085
505013	100,02	501087	109,60			501616	247,42	10x090
505014	108,88	501088	119,32			501617	258,38	10x095
505015	121,48	501089	133,14			501618	269,34	10x100
505016	130,60	501090	143,18			501619	280,30	10x105
505017	139,78	501091	153,24			501620	291,26	10x110
505018	148,96	501092	163,20			501621	302,22	10x115
						501622	313,18	10x120
505020	55,02	501094	60,32	501358	80,18	501623	324,14	10x125
505021	60,58	501095	66,36	501359	88,12	501624	335,10	10x130
505022	66,98	501096	73,42	501360	97,42	501625	346,06	10x135
505023	73,42	501097	80,36	501361	106,80	501626	357,02	10x140
505024	79,76	501098	87,36	501362	116,04	501627	367,98	10x145
505025	86,22	501099	94,46	501363	125,40	501628	378,94	10x150
505026	92,40	501100	101,24	501364	134,40	501629	389,90	10x155
505027	98,72	501101	108,22			501630	400,86	10x160
505028	103,38	501102	113,30	501366	150,46	501631	411,82	10x165
505029	111,56	501103	122,22			501632	422,78	10x170
505030	118,02	501104	129,22	501368	171,66	501633	433,74	10x175
505031	124,28	501105	136,24			501634	444,70	10x180
505032	130,78	501106	143,26	501370	190,24	501635	455,66	10x185
505034	143,50	501107	157,20			501636	466,62	10x190
505035	156,26	501108	171,28			501637	477,58	10x195
505036	169,10	501109	185,28			501638	488,54	10x200
505037	181,12	501110	198,48			501639	499,50	10x205
505038	199,42	501111	218,54			501640	510,46	10x210
505039	212,22	501112	232,54			501641	521,42	10x215
505040	225,04	501113	246,56			501642	532,38	10x220
505043	94,06	501114	103,14			501643	543,34	10x225
505044	102,88	501115	112,66	501379	149,64	501644	554,30	10x230
505045	111,74	501116	122,48	501380	162,52	501645	565,26	10x235
505046	120,62	501117	132,16	501381	175,50	501646	576,22	10x240
505047	129,54	501118	141,88	501382	188,40	501647	587,18	10x245
505048	138,34	501119	151,60	501383	201,34	501648	598,14	10x250
505049	147,08	501120	161,18			501649	609,10	10x255
505050	156,02	501121	170,90	501385	226,96	501650	620,06	10x260
505051	164,90	501122	180,62			501651	631,02	10x265
505052	173,88	501123	190,56	501387	253,00	501652	641,98	10x270
505053	181,12	501124	198,48			501653	652,94	10x275
505054	190,06	501125	208,24	501389	276,52	501654	663,90	10x280
505055	207,80	501126	227,70			501655	674,86	10x285
505056	225,52	501127	247,18			501656	685,82	10x290
505057	243,34	501128	266,66			501657	696,78	10x295
505058	261,14	501129	286,06			501658	707,74	10x300
505059	287,22	501130	314,76					10x305
505060	305,58	501131	334,76					10x310
505061	323,84	501132	354,84					10x315
505063	124,72	501133	136,60			501662	340,86	16x025

06



DIN 933 métrica



Ref. 8.8	€/ 100 8.8	Ref. 8.8 Zn	€/ 100 8.8 Zn	Ref. 10.9	€/ 100 10.9	Ref. A2	€/ 100 A2	Longitud mm	Ref. 8.8	€/ 100 8.8	Ref. 8.8 Zn	€/ 100 8.8 Zn	Ref. 10.9	€/ 100 10.9	Ref. A2	€/ 100 A2	Longitud mm
505064	136,60	501134	149,64	501398	198,74	501663	348,20	16x030	505139	524,00	501197	574,16					22x080
505065	148,34	501135	162,48	501399	215,80	501664	378,06	16x035	505141	570,18	501198	624,76					22x090
505066	160,24	501136	175,56	501400	233,16	501665	408,40	16x040	505142	614,58	501199	673,38					22x100
505067	172,44	501137	189,00	501401	250,96	501666	439,66	16x045	505143	659,00	501200	722,04					22x110
505068	182,94	501138	200,46	501402	266,22	501667	466,36	16x050	505144	705,18	501201	772,70					22x120
505069	195,40	501139	214,06			501668	498,06	16x055	505145	747,78	501202	819,34					22x130
505070	207,80	501140	227,70	501404	302,36	501669	529,76	16x060	505146	795,70	501203	871,92					22x140
505071	218,48	501141	239,40			501670	556,90	16x065	505147	840,16	501204	920,60					22x150
505072	230,88	501142	253,06	501406	336,06	501671	588,58	16x070	505153	433,40	501205	474,94	501469	630,66	501734	1.496,44	24x040
505073	243,34	501143	266,66			501672	620,28	16x075	505154	460,08	501206	504,06	501470	669,34	501735	1.517,80	24x045
505074	255,74	501144	280,28	501408	372,20	501673	651,98	16x080	505155	486,64	501207	533,28	501471	708,16	501736	1.568,34	24x050
505075	278,86	501145	305,58	501409	405,78	501674	710,84	16x090	505156	513,34	501208	562,44			501737	1.654,22	24x055
505076	302,00	501146	330,88	501410	439,32	501675	780,88	16x100	505157	540,00	501209	591,70	501473	785,66	501738	1.657,22	24x060
505077	326,80	501147	358,12	501411	475,54	501676	845,20	16x110	505158	566,56	501210	620,90			501739	1.739,02	24x065
505078	349,98	501148	383,42	501412	509,10	501677	930,78	16x120	505159	593,26	501211	650,06	501475	863,22	501740	1.820,80	24x070
505079	373,00	501149	408,72			501678	1.019,70	16x130	505160	618,12	501212	677,30			501741	1.897,06	24x075
505080	397,90	501150	436,00			501679	1.087,72	16x140	505161	644,80	501213	706,48	501477	938,14	501742	1.978,86	24x080
505081	420,92	501151	461,30			501680	1.150,84	16x150	505163	698,04	501215	764,90	501479	1.015,66	501744	2.142,38	24x090
505085	198,98							18x030	505164	751,38	501216	823,30	501480	1.093,24	501745	2.305,96	24x100
505086	198,98	501153	217,98					18x035	505165	804,64	501217	881,58	501481	1.170,76	501746	2.469,48	24x110
505087	213,12	501154	233,62					18x040	505166	857,92	501218	940,08	501482	1.248,28	501747	2.633,08	24x120
505088	227,40	501155	249,16					18x045	505167	911,24	501219	998,42			501748	2.936,44	24x130
505089	241,60	501156	264,70					18x050	505168	964,52	501220	1.056,84			501749	3.182,12	24x140
505090	257,60	501157	282,20					18x055	505169	1.016,02	501221	1.113,26			501750	3.430,02	24x150
505091	271,80	501158	297,78					18x060	505179	896,88	501226	982,72	501490	1.304,94	501755	2.551,28	27x060
505092	286,00	501159	313,32					18x065	505180	937,84	501227	1.027,68			501756	2.667,80	27x065
505093	300,12	501160	328,96					18x070	505181	978,78	501228	1.072,48	501492	1.424,20	501757	2.784,32	27x070
505094	314,40	501161	344,52					18x075	505182	1.019,74	501229	1.117,42			501758	2.900,82	27x075
505095	330,38	501162	361,94					18x080	505183	1.060,74	501230	1.162,26	501494	1.543,44	501759	3.017,36	27x080
505097	358,80	501163	393,20					18x090	505185	1.144,92	501231	1.254,40	501495	1.665,72	501760	3.256,52	27x090
505098	387,20	501164	424,30					18x100	505186	1.226,76	501232	1.344,18	501496	1.784,96	501761	3.489,62	27x100
505099	417,40	501165	457,40					18x110	505187	1.310,80	501233	1.436,34	501497	1.907,24	501762	3.728,80	27x110
505100	445,80	501166	488,60					18x120	505188	1.394,92	501234	1.528,48	501498	2.029,66	501763	3.967,96	27x120
505101	476,04	501167	521,58					18x130	505189	1.573,80	501235	1.724,58			501764	4.477,02	27x130
505102	504,40	501168	552,76					18x140	505190	1.638,50	501236	1.795,46			501765	4.660,96	27x140
505103	532,92	501169	583,88					18x150	505191	1.724,82	501237	1.889,86			501766	4.906,28	27x150
505104	257,60					501699	712,28	20x030	505202	1.272,00	501238	1.393,88	501502	1.850,82			30x070
505105	257,60	501171	282,20			501700	750,96	20x035	505203	1.322,70	501239	1.449,30					30x075
505106	275,32	501172	301,68	501436	400,58	501701	781,58	20x040	505204	1.373,34	501240	1.504,86	501504	1.998,26	501769	3.906,64	30x080
505107	293,12	501173	321,16	501437	426,42	501702	832,06	20x045	505205	1.476,82	501241	1.618,22	501505	2.148,78	501770	4.201,00	30x090
505108	312,60	501174	342,56	501438	454,84	501703	863,48	20x050	505206	1.578,18	501242	1.729,28	501506	2.296,24	501771	4.489,26	30x100
505109	330,38	501175	361,94			501704	912,54	20x055	505207	1.679,52	501243	1.840,36	501507	2.443,68	501772	4.777,50	30x110
505110	348,14	501176	381,50	501440	506,56	501705	961,66	20x060	505208	1.782,92	501244	1.953,62	501508	2.594,26	501773	5.071,88	30x120
505111	367,74	501177	402,88			501706	1.015,62	20x065	505209	1.961,94	501245	2.149,76			501774	5.580,90	30x130
505112	385,46	501178	422,38	501442	560,82	501707	1.064,64	20x070	505210	2.069,70	501246	2.267,82			501775	5.887,54	30x140
505113	403,26	501179	441,82			501708	1.113,72	20x075	505211	2.177,50	501247	2.386,04			501776	6.194,18	30x150
505114	422,78	501180	463,22	501444	615,14	501709	1.167,72	20x080	505218	1.871,36	501248	2.050,54	501512	2.722,88			33x080
505116	458,28	501182	502,16	501446	666,80	501711	1.265,82	20x090	505219	2.010,66	501249	2.203,24	501513	2.925,58			33x090
505118	495,54	501183	543,02	501447	721,06	501712	1.368,88	20x100	505220	2.136,06	501250	2.340,58	501514	3.107,94			33x100
505119	532,92	501184	583,88	501448	775,38	501713	1.471,86	20x110	505221	2.270,60	501251	2.488,14	501515	3.303,96			33x110
505120	568,46	501185	622,84	501449	826,96	501714	1.570,04	20x120	505222	2.414,62	501252	2.645,90	501516	3.513,44			33x120
505121	603,88	501186	661,72			501715	1.714,44	20x130	505223	2.589,92	501253	2.837,96					33x130
505122	641,18	501187	702,66			501716	1.869,54	20x140	505224	2.762,86	501254	3.027,46					33x140
505123	676,70	501188	741,52			501717	1.973,16	20x150	505225	2.902,20	501255	3.180,12					33x150
505131	337,48	501189	369,82					22x040	505231	2.298,58	501256	2.518,64	501520	3.344,46			36x080
505132	365,88	501190	400,98					22x045	505232	2.461,10	501257	2.696,74	501521	3.580,96			36x090
505133	388,98	501191	426,28					22x050	505233	2.646,78	501258	2.900,28	501522	3.851,20			36x100
505134	412,12	501192	451,50					22x055	505234	2.786,14	501259	3.052,92	501523	4.053,92			36x110
505135	433,40	501193	474,94					22x060	505235	2.925,40	501260	3.205,56	501524	4.256,62			36x120
505136	456,54	501194	500,18					22x065	505236	3.134,44	501261	3.434,54					36x130
505137	477,78	501195	523,56					22x070	505237	3.343,40	501262	3.663,50					36x140
505138	500,94	501196	548,86					22x075	505238	3.522,16	501263	3.859,44					36x150



DIN 961 métrica fina. 8.8

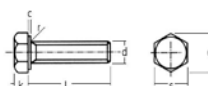

Ref. 8.8	Longitud mm	€/100 8.8	Ref. 8.8	Longitud mm	€/100 8.8	Ref. 8.8	Longitud mm	€/100 8.8	Ref. 8.8	Longitud mm	€/100 8.8
506300	08x1,00x016	57,26	506332	10x1,25x050	159,74	506364	14x1,50x030	288,44	506396	18x1,50x060	799,34
506301	08x1,00x020	61,08	506333	10x1,25x055	179,94	506365	14x1,50x035	304,70	506397	18x1,50x065	868,50
506302	08x1,00x025	65,42	506334	10x1,25x060	179,94	506366	14x1,50x040	317,82	506398	18x1,50x070	868,50
506303	08x1,00x030	70,34	506335	10x1,25x065	194,64	506367	14x1,50x045	340,78	506399	18x1,50x080	946,94
506304	08x1,00x035	76,32	506336	10x1,25x070	209,38	506368	14x1,50x050	363,74	506400	20x1,50x030	750,16
506305	08x1,00x040	83,96	506337	10x1,25x080	239,36	506369	14x1,50x055	382,82	506401	20x1,50x035	773,12
506306	08x1,00x045	92,72	506338	12x1,25x020	161,96	506370	14x1,50x060	402,50	506402	20x1,50x040	799,34
506307	08x1,00x050	101,98	506339	12x1,25x025	169,02	506371	14x1,50x065	421,00	506403	20x1,50x045	848,82
506308	08x1,00x055	110,68	506340	12x1,25x030	183,74	506372	14x1,50x070	439,48	506404	20x1,50x050	898,02
506309	08x1,00x060	119,42	506341	12x1,25x035	191,94	506373	14x1,50x080	475,86	506405	20x1,50x055	943,64
506310	08x1,00x070	140,42	506342	12x1,25x040	199,00	506374	14x1,50x090	521,18	506406	20x1,50x060	983,00
506311	08x1,00x080	161,38	506343	12x1,25x045	216,46	506375	14x1,50x100	560,50	506407	20x1,50x065	1.094,22
506312	10x1,00x016	108,84	506344	12x1,25x050	231,72	506376	14x1,50x120	717,36	506408	20x1,50x070	1.094,22
506313	10x1,00x020	109,02	506345	12x1,25x055	252,98	506377	16x1,50x025	338,10	506409	20x1,50x080	1.176,50
506314	10x1,00x025	116,66	506346	12x1,25x060	273,70	506378	16x1,50x030	384,90	506410	22x1,50x040	1.113,90
506315	10x1,00x030	124,30	506347	12x1,25x065	291,70	506379	16x1,50x035	404,02	506411	22x1,50x045	1.179,78
506316	10x1,00x035	131,92	506348	12x1,25x070	313,98	506380	16x1,50x040	423,68	506412	22x1,50x050	1.248,66
506317	10x1,00x040	140,66	506349	12x1,25x080	359,86	506381	16x1,50x045	444,24	506413	22x1,50x055	1.310,66
506318	10x1,00x045	149,94	506350	12x1,50x020	161,96	506382	16x1,50x050	460,64	506414	22x1,50x060	1.375,98
506319	10x1,00x050	159,74	506351	12x1,50x025	169,02	506383	16x1,50x055	501,48	506415	22x1,50x065	1.441,54
506320	10x1,00x055	179,94	506352	12x1,50x030	183,74	506384	16x1,50x060	501,48	506416	22x1,50x070	1.441,54
506321	10x1,00x060	179,94	506353	12x1,50x035	191,94	506385	16x1,50x065	521,18	506417	22x1,50x080	1.635,06
506322	10x1,00x065	194,64	506354	12x1,50x040	199,00	506386	16x1,50x070	537,56	506418	24x1,50x110	2.683,62
506323	10x1,00x070	209,38	506355	12x1,50x045	216,46	506387	16x1,50x080	605,86	506419	24x2,00x040	1.375,98
506324	10x1,00x080	239,36	506356	12x1,50x050	231,72	506388	16x1,50x090	669,92	506420	24x2,00x045	1.458,54
506325	10x1,25x016	109,02	506357	12x1,50x055	252,98	506389	16x1,50x100	730,48	506421	24x2,00x050	1.523,86
506326	10x1,25x020	109,02	506358	12x1,50x060	273,70	506390	18x1,50x030	590,04	506422	24x2,00x055	1.592,42
506327	10x1,25x025	116,66	506359	12x1,50x065	291,70	506391	18x1,50x035	606,14	506423	24x2,00x060	1.677,68
506328	10x1,25x030	124,30	506360	12x1,50x070	313,98	506392	18x1,50x040	642,20	506424	24x2,00x065	1.752,82
506329	10x1,25x035	131,92	506361	12x1,50x080	359,86	506393	18x1,50x045	681,56	506425	24x2,00x070	1.828,56
506330	10x1,25x040	140,66	506362	14x1,50x020	275,34	506394	18x1,50x050	717,36	506426	24x2,00x080	1.998,80
506331	10x1,25x045	149,94	506363	14x1,50x025	275,34	506395	18x1,50x055	753,42	506427	24x2,00x090	2.129,98

06



DIN 931 métrica

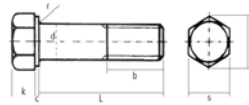

Ref. 8.8	€/ 100 8.8	Ref. 8.8 Zn	€/ 100 8.8 Zn	Ref. 10.9	€/ 100 10.9	Ref. A2	€/ 100 A2	Longitud mm
506511	17,16	520500	18,48					06x030
506512	19,48	520501	20,98					06x035
506513	21,72	520502	23,38			520929	51,40	06x040
506514	24,12	520503	25,92			520930	51,40	06x045
506515	26,24	520504	28,22			520931	60,32	06x050
506516	28,66	520505	30,76			520932	65,72	06x055
506517	30,70	520506	33,04			520933	70,64	06x060
506518	33,12	520507	35,52			520934	76,06	06x065
506519	35,18	520508	37,84			520935	80,92	06x070
506520	39,68	520509	42,72			520936	93,80	06x075
506521	39,68	520510	42,72			520940	93,80	06x080
506522	49,60	520511	53,32			520941	107,70	06x090
506523	54,80	520512	58,92			520942	122,22	06x100
521073	58,68	520513	63,06			520943	140,84	06x110
521074	63,38	520514	68,22			520944	152,24	06x120
521075	30,32	520515	32,64					08x030
506524	35,18	520516	37,84	520820	46,88			08x035
506525	39,98	520517	43,06	520821	53,32	520945	104,36	08x040
506526	42,90	520518	46,08	520822	57,26	520946	111,94	08x045
506527	46,78	520519	50,32	520823	62,32	520947	115,46	08x050
506528	49,86	520520	53,58	520824	66,54	520948	123,08	08x055
506529	53,76	520521	57,80	520825	71,64	520949	132,60	08x060
506530	57,60	520522	61,96			520950	142,12	08x065
506531	61,46	520523	66,12	520826	81,90	520951	151,68	08x070
506532	65,14	520524	70,10			520952	179,32	08x075
506533	68,96	520525	74,16	520827	110,58	520953	170,30	08x080
506534	76,54	520526	82,30	520828	102,08	520954	188,90	08x090
506535	84,22	520527	90,66	520829	112,38	520955	208,00	08x100
506536	95,30	520528	102,50	520830	127,14	520956	239,56	08x110
506537	103,38	520529	111,18	520831	137,86	520957	259,68	08x120
506538	125,32	520530	134,84			520958	287,44	08x130
506539	134,40	520531	144,50			520959	316,26	08x140
506540	143,42	520532	154,24			520960	346,16	08x150
506544	62,76	520533	74,96	520832	92,90	520961	160,30	10x040
506545	69,70	520534	81,36	520833	100,90	520962	174,02	10x045
506546	75,66	520535	79,66	520834	98,86	520963	177,74	10x050
506547	74,10	520536	84,96	520835	105,30	520964	189,44	10x055
506548	79,02	520537	90,98			520965	202,86	10x060
506549	84,58	520538	96,92	520836	112,74	520966	216,24	10x065
506550	90,16	520539	102,98	520837	127,68	520967	229,64	10x070
506551	95,74	520540	109,02			520968	243,08	10x075
506552	101,34	520541	120,84	520838	149,82	520969	269,44	10x080
506553	112,38	520542	132,84	520839	164,76	520970	296,22	10x090
506554	123,52							10x095
506555	140,14	520544	150,74	520840	186,84	520971	336,06	10x100
506556	151,38	520545	162,70	520841	201,78	520972	362,84	10x110
506557	162,26	520546	174,52	520842	216,42	520973	389,22	10x120
506558	191,54	520547	206,02	520843	255,38	520974	428,30	10x130
506559	203,08	520548	218,42	520844	270,82	520975	467,06	10x140
506560	215,04	520549	231,22	520845	286,68	520976	508,30	10x150
506561	257,48	520550	276,88					10x160
506562	286,06	520551	307,64					10x170
506563	300,38	520552	323,00					10x180
506565	329,04	520553	353,76					10x200
506566	94,96	520554	102,00			520977	218,58	12x040
506567	103,56	520555	111,36	520846	138,16	520978	238,60	12x045
506568	104,80	520556	112,66	520847	139,70	520979	251,26	12x050
506569	112,92	520557	121,42	520848	150,56	520980	270,74	12x055
506570	120,84	520558	129,98	520849	161,12	520981	289,78	12x060
506571	126,80	520559	136,38			520982	304,04	12x065
506572	134,84	520560	144,84	520850	179,58	520983	323,08	12x070
506573	142,64	520561	153,42			520984	342,10	12x075
506574	150,80	520562	162,16	520851	201,06	520985	361,58	12x080
506576	164,86	520563	179,22	520852	222,20	520986	399,60	12x090
506578	180,38	520564	193,96	520853	240,50	520987	432,48	12x100
506579	196,58	520565	211,32	520854	262,14	520988	471,40	12x110
506580	212,86	520566	228,88	520855	283,76	520989	510,36	12x120
506581	238,00	520567	255,92	520856	317,30	520990	565,42	12x130
506582	254,80	520568	274,04	520857	339,76	520991	605,46	12x140
506583	271,76	520569	292,18	520858	362,28	520992	645,52	12x150
506584	345,56	520570	371,52			520993	739,54	12x160
506585	394,08	520571	423,70					12x170
506586	415,98	520572	447,28			520994	913,54	12x180

Ref. 8.8	€/ 100 8.8	Ref. 8.8 Zn	€/ 100 8.8 Zn	Ref. 10.9	€/ 100 10.9	Ref. A2	€/ 100 A2	Longitud mm
506588	459,68	520573	494,28			520995	1.009,72	12x200
521076	609,00	520574	654,88					12x220
521077	661,64	520575	711,52					12x240
521078	706,14	520576	768,18					12x260
521079	767,14	520577	824,88					12x280
521080	819,78	520578	881,54					12x300
506589	158,80	520579	170,80	520859	211,82	520996	392,10	14x050
506590	170,58	520580	183,48	520860	227,50	520997	421,18	14x055
506591	182,26	520581	195,96	520861	242,98	520998	449,82	14x060
506592	193,28	520582	207,88			520999	476,98	14x065
506593	204,88	520583	220,28	520862	273,10	521000	505,64	14x070
506594	216,42	520584	232,72			521001	534,22	14x075
506595	228,00	520585	245,20	520863	304,04	521002	562,84	14x080
506597	247,36	520586	265,96	520864	329,84	521003	610,56	14x090
506598	270,56	520587	290,88	520865	360,70	521004	667,78	14x100
506599	293,68	520588	315,90	520866	391,62	521005	725,02	14x110
506600	318,86	520589	342,94	520867	425,08	521006	787,02	14x120
506601	351,36	520590	377,76	520868	468,50	521007	834,78	14x130
506602	375,46	520591	403,76	520869	500,60	521008	892,00	14x140
506603	399,54	520592	429,60	520870	532,74	521009	949,26	14x150
506604	476,52	520593	512,46			521010	1.092,76	14x160
506605	542,46	520594	583,20					14x170
506606	571,62	520595	614,64			521011	1.345,12	14x180
506608	632,46	520596	680,08			521012	1.488,24	14x200
521081	799,32	520597	859,46					14x220
521082	863,66	520598	928,72					14x240
521083	928,12	520599	998,02					14x260
521084	992,60	520600	1.067,32					14x280
521085	1.056,96	520601	1.136,52					14x300
506610	192,92	520602	207,50	520871	257,28	521013	476,38	16x050
506611	207,42	520603	222,98	520872	276,52	521014	511,96	16x055
506612	221,88	520604	238,60	520873	295,80	521015	531,94	16x060
506613	236,34	520605	254,04			521016	566,52	16x065
506614	250,72	520606	269,56	520874	334,26	521017	601,14	16x070
506615	265,14	520607	285,06			521018	635,72	16x075
506616	279,56	520608	300,56	520875	372,68	521019	670,34	16x080
506618	308,36	520609	331,64	520876	411,20	521020	739,54	16x090
506620	335,40	520610	360,78	520877	447,28	521021	804,38	16x100
506621	364,26	520611	391,72	520878	485,70	521022	873,60	16x110
506622	393,20	520612	422,78	520879	524,24	521023	942,82	16x120
506623	444,50	520613	477,98	520880	592,62	521024	1.023,96	16x130
506624	475,30	520614	511,16	520881	633,80	521025	1.095,22	16x140
506625	506,30	520615	544,44	520882	675,06	521026	1.166,42	16x150
506626	593,00	520616	637,66			521027	1.237,66	16x160
506627	627,18	520617	674,42					16x170
506628	661,28	520618	711,02			521028	1.605,44	16x180
506630	729,54	520619	784,44			521029	1.771,20	16x200
521086	1.010,82	520620	1.086,86			521030	2.293,70	16x220
521087	1.097,28	520621	1.179,88			521031	2.489,96	16x240
521088	1.183,70	520622	1.272,84			521032	2.686,22	16x260
521089	1.270,20	520623	1.365,92			521033	2.882,46	16x280
521090	1.356,74	520624	1.458,78			521034		



DIN 931 métrica

Ref. 8.8	€/ 100 8.8	Ref. 8.8 Zn	€/ 100 8.8 Zn	Ref. 10.9	€/ 100 10.9	Ref. A2	€/ 100 A2	Longitud mm
506650	1.286,48	520646	1.383,26					18x220
506652	1.394,54	520647	1.499,56					18x240
521096	1.502,68	520648	1.615,80					18x260
521097	1.610,78	520649	1.732,02					18x280
521098	1.718,86	520650	1.848,28					18x300
521099	2.474,00	520651	2.660,16					18x320
521100	2.620,48	520652	2.817,62					18x340
521101	2.766,76	520653	2.975,06					18x360
521102	2.913,18	520654	3.132,50					18x380
521103	3.059,58	520655	3.289,88					18x400
521104	373,30	520656	401,46	520883	497,82	521035	921,60	20x060
506654	394,94	520657	424,72			521036	975,00	20x065
506655	416,66	520658	447,96	520884	555,50	521037	999,06	20x070
506656	438,28	520659	471,28			521038	1.050,94	20x075
506657	459,92	520660	494,54	520885	613,22	521039	1.102,84	20x080
506659	503,24	520661	541,12	520886	670,96	521040	1.206,60	20x090
506661	546,50	520662	587,60	520887	728,62	521041	1.310,40	20x100
506662	589,78	520663	634,20	520888	786,34	521042	1.515,22	20x110
506663	633,04	520664	680,68	520889	844,04	521043	1.626,46	20x120
506664	658,30	520665	707,86	520890	877,76	521044	1.741,04	20x130
506665	701,58	520666	754,34	520891	935,40	521045	1.855,54	20x140
506666	762,92	520667	820,28	520892	1.017,22	521046	2.017,70	20x150
506667	953,52	520668	1.025,28			521047	2.132,20	20x160
506668	1.002,58	520669	1.077,98					20x170
506669	1.055,92	520670	1.135,48			521049	2.563,54	20x180
506671	118,04	520671	1.250,06			521050	2.822,46	20x200
506673	1.605,38	520672	1.726,16			521051	3.642,92	20x220
521105	1.740,44	520673	1.871,50			521052	3.949,54	20x240
521106	1.875,56	520674	2.016,76			521053	4.256,18	20x260
521107	2.010,76	520675	2.162,10			521054	4.562,84	20x280
521108	2.145,94	520676	2.307,48			521055	4.869,46	20x300
521109	3.088,86	520677	3.521,40					20x320
521110	3.286,54	520678	3.533,82					20x340
521111	3.462,14	520679	3.722,78					20x360
521112	3.645,20	520680	3.919,52					20x380
521113	3.828,18	520681	4.116,22					20x400
506674	564,18	520682	606,60					22x070
506675	594,26	520683	639,00					22x075
506676	624,36	520684	671,40					22x080
506678	684,58	520685	736,14					22x090
506679	742,82	520686	798,74					22x100
506680	803,04	520687	863,56					22x110
506681	863,22	520688	928,30					22x120
506682	903,42	520689	971,38					22x130
506683	963,70	520690	1.036,20					22x140
506684	1.023,90	520691	1.100,94					22x150
506685	1.151,90	520692	1.238,66					22x160
506686	1.215,90	520693	1.307,42					22x170
506687	1.279,88	520694	1.376,26					22x180
506689	1.407,82	520695	1.513,86					22x200
521114	1.945,86	520696	2.092,36					22x220
521115	2.108,02	520697	2.266,74					22x240
521116	2.275,66	520698	2.446,92					22x260
521117	2.432,32	520699	2.618,48					22x280
521118	2.594,48	520700	2.789,78					22x300
521119	3.733,00	520701	4.014,04					22x320
521120	3.952,66	520702	4.250,12					22x340
521121	4.172,16	520703	4.486,24					22x360
521122	4.391,74	520704	4.722,32					22x380
521123	4.611,30	520705	4.958,38					22x400
506690	694,64	520706	746,98			521056	1.839,04	24x070
506691	730,78	520707	785,80			521057	1.934,72	24x075
506692	766,94	520708	824,62	520893	1.022,56	521058	1.978,32	24x080
506694	859,28	520709	923,96	520894	1.145,70	521059	2.216,56	24x090
506695	931,52	520710	1.001,66	520895	1.242,08	521060	2.403,02	24x100
506696	1.003,80	520711	1.079,36	520896	1.338,42	521061	2.589,42	24x110
506697	1.074,06	520712	1.154,92	520897	1.432,18	521062	2.770,66	24x120
506698	1.124,32	520713	1.208,90	520898	1.499,10	521063	2.900,14	24x130
506699	1.194,58	520714	1.284,48	520899	1.592,70	521064	3.081,40	24x140
506700	1.264,82	520715	1.360,00	520900	1.686,42	521065	3.262,66	24x150
506701	1.418,54	520716	1.525,34			521066	3.443,94	24x160
506702	1.493,20	520720	1.605,50					24x170
506703	1.567,86	520721	1.685,86			521067	4.530,76	24x180
506705	1.717,18	520722	1.846,46			521068	4.962,28	24x200
521124	2.351,32	520723	2.528,22			521069	5.746,06	24x220
521125	2.526,92	520724	2.717,08			521070	6.175,34	24x240
521126	2.702,60	520725	2.906,04			521071	7.338,44	24x260
521127	2.878,30	520726	3.094,94			521072	7.815,50	24x280
521128	3.054,02	520727	3.283,80					24x300
521129	4.373,44	520728	4.702,64					24x320
521130	4.611,30	520729	4.958,38					24x340
521131	4.849,18	520730	5.214,24					24x360
521132	5.087,10	520731	5.470,04					24x380
521133	5.324,98	520732	5.725,74					24x400

Ref. 8.8	€/ 100 8.8	Ref. 8.8 Zn	€/ 100 8.8 Zn	Ref. 10.9	€/ 100 10.9	Ref. A2	€/ 100 A2	Longitud mm
506706	1.218,30	520733	1.309,96	520901	1.624,36			27x080
506707	1.327,96	520734	1.427,92	520902	1.770,58			27x090
506708	1.437,64	520735	1.545,78	520903	1.916,80			27x100
506709	1.549,66	520736	1.666,22	520904	2.066,16			27x110
506710	1.656,90	520737	1.781,68	520905	2.209,30			27x120
506711	1.740,44	520738	1.871,40	520906	2.320,56			27x130
506712	1.823,84	520739	1.961,16	520907	2.431,78			27x140
506713	1.931,12	520740	2.076,38	520908	2.574,86			27x150
506714	2.038,40	520741	2.191,82					27x160
506715	2.145,68	520742	2.307,16					27x170
506716	2.252,96	520743	2.422,56					27x180
506718	2.455,60	520744	2.640,44					27x200
521134	3.119,40	520745	3.354,18					27x220
521135	3.363,84	520746	3.621,34					27x240
521136	3.616,32	520747	3.888,54					27x260
521137	3.864,72	520748	4.155,60					27x280
521138	4.113,20	520749	4.422,76					27x300
521139	5.551,18	520750	5.969,02					27x320
521140	5.867,40	520751	6.308,96					27x340
521141	6.183,58	520752	6.649,00					27x360
521142	6.499,84	520753	6.989,04					27x380
521143	6.816,04	520754	7.329,08					27x400
521144	1.648,86	520755	1.772,88	520909	2.198,38			30x080
506719	1.786,82	520756	1.921,32	520910	2.382,44			30x090
506720	1.924,78	520757	2.069,70	520911	2.566,46			30x100
506721	2.065,36	520758	2.220,90	520912	2.753,80			30x110
506722	2.208,44	520759	2.374,64	520913	2.944,52			30x120
506723	2.308,80	520760	2.482,64	520914	3.078,42			30x130
506724	2.446,86	520761	2.631,02	520915	3.262,48			30x140
506725	2.584,82	520762	2.779,48	520916	3.446,50			30x150
506726	2.722,88	520763	2.927,80					30x160
506727	2.860,88	520764	3.076,24					30x170
506728	3.011,50	520765	3.238,18					30x180
506730	3.287,52	520766	3.534,96					30x200
521145	4.098,18	520767	4.406,56					30x220
521146	4.415,60	520768	4.748,00					30x240
521147	4.733,04	520769	5.089,30					30x260
521148	5.050,48	520770	5.430,64					30x280
521149	5.367,96	520771	5.772,02					30x300
521150	7.453,78	520772	8.014,86					30x320
521151	7.870,02	520773	8.462,38					30x340
521152	8.286,28	520774	8.909,88					30x360
521153	8.700,56	520775	9.357,46					30x380
521154	9.118,64	520776	9.804,96					30x400
521155	2.625,24	520777	2.822,84	520917	3.500,32			33x100
521156	2.815,74	520778	3.027,72	520918	3.754,32			33x110
521160	3.008,98	520779	3.235,44	520919	4.011,98			33x120
521161	3.202,18	520780	3.443,24	520920	4.269,56			33x130
521162	3.367,84	520781	3.621,34	520921	4.490,46			33x140
521163	3.561,06	520782	3.829,12	520922	4.748,12			33x150
521164	3.726,68	520783	4.00					

DIN 960 métrica fina. 8.8

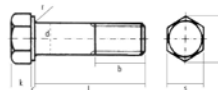

Ref. 8.8	Longitud mm	€/ 100 8.8	Ref. 8.8	Longitud mm	€/ 100 8.8	Ref. 8.8	Longitud mm	€/ 100 8.8	Ref. 8.8	Longitud mm	€/ 100 8.8
508000	08x1,00x030	81,80	508036	10x1,25x100	334,24	508072	14x1,50x055	376,84	508108	18x1,50x100	1.163,40
508001	08x1,00x035	85,08	508037	10x1,25x110	360,46	508073	14x1,50x060	409,34	508109	18x1,50x110	1.300,84
508002	08x1,00x040	88,30	508038	10x1,25x120	409,34	508074	14x1,50x065	425,76	508110	18x1,50x120	1.402,20
508003	08x1,00x045	98,16	508039	10x1,25x130	442,16	508075	14x1,50x070	442,16	508111	18x1,50x130	1.491,04
508004	08x1,00x050	104,68	508040	12x1,25x040	203,38	508076	14x1,50x080	474,94	508112	18x1,50x140	1.602,26
508005	08x1,00x055	117,76	508041	12x1,25x045	209,90	508077	14x1,50x090	531,00	508113	18x1,50x150	1.713,46
508006	08x1,00x060	134,10	508042	12x1,25x050	216,46	508078	14x1,50x100	583,46	508114	18x1,50x160	1.802,32
508007	08x1,00x065	150,48	508043	12x1,25x055	265,52	508079	14x1,50x110	661,88	508115	18x1,50x180	2.129,98
508008	08x1,00x070	153,76	508044	12x1,25x060	288,44	508080	14x1,50x120	717,36	508116	18x1,50x200	2.293,64
508009	08x1,00x080	173,92	508045	12x1,25x065	314,54	508081	14x1,50x130	769,84	508117	20x1,50x060	1.022,38
508010	08x1,00x090	196,80	508046	12x1,25x070	327,66	508082	14x1,50x140	832,42	508118	20x1,50x065	1.077,80
508011	08x1,00x100	222,98	508047	12x1,25x080	363,74	508083	14x1,50x150	907,84	508119	20x1,50x070	1.113,90
508012	10x1,00x035	140,66	508048	12x1,25x090	422,48	508084	14x1,50x160	1.051,58	508120	20x1,50x080	1.179,78
508013	10x1,00x040	147,18	508049	12x1,25x100	474,94	508085	14x1,50x180	1.156,84	508121	20x1,50x090	1.310,66
508014	10x1,00x045	153,76	508050	12x1,25x110	547,40	508086	14x1,50x200	1.258,50	508122	20x1,50x100	1.441,54
508015	10x1,00x050	167,36	508051	12x1,25x120	583,46	508087	16x1,50x050	465,12	508123	20x1,50x110	1.621,94
508016	10x1,00x055	187,00	508052	12x1,25x130	619,24	508088	16x1,50x055	474,94	508124	20x1,50x120	1.729,86
508017	10x1,00x060	200,10	508053	12x1,25x140	655,34	508089	16x1,50x060	484,78	508125	20x1,50x130	1.864,62
508018	10x1,00x065	219,70	508054	12x1,25x150	694,66	508090	16x1,50x065	534,28	508126	20x1,50x140	1.988,94
508019	10x1,00x070	229,56	508055	12x1,50x040	203,38	508091	16x1,50x070	553,96	508127	20x1,50x150	2.129,98
508020	10x1,00x080	268,78	508056	12x1,50x045	209,90	508092	16x1,50x080	619,24	508128	20x1,50x160	2.231,64
508021	10x1,00x090	301,42	508057	12x1,50x050	216,46	508093	16x1,50x090	688,12	508129	20x1,50x180	2.438,26
508022	10x1,00x100	334,24	508058	12x1,50x055	265,52	508094	16x1,50x100	753,42	508130	20x1,50x200	2.686,92
508023	10x1,00x110	360,46	508059	12x1,50x060	288,44	508095	16x1,50x110	848,82	508131	22x1,50x070	1.546,82
508024	10x1,00x120	409,34	508060	12x1,50x065	314,54	508096	16x1,50x120	927,52	508132	22x1,50x080	1.710,18
508025	10x1,00x130	442,16	508061	12x1,50x070	327,66	508097	16x1,50x130	1.002,70	508133	22x1,50x090	1.841,66
508026	10x1,25x035	140,66	508062	12x1,50x080	363,74	508098	16x1,50x140	1.176,50	508134	22x1,50x100	1.979,12
508027	10x1,25x040	147,18	508063	12x1,50x090	422,48	508099	16x1,50x150	1.199,46	508135	22x1,50x110	2.211,98
508028	10x1,25x045	153,76	508064	12x1,50x100	474,94	508100	16x1,50x160	1.284,42	508136	22x1,50x120	2.368,78
508029	10x1,25x050	167,36	508065	12x1,50x110	547,40	508101	16x1,50x180	1.458,54	508137	22x1,50x130	2.539,62
508030	10x1,25x055	187,00	508066	12x1,50x120	583,46	508102	16x1,50x200	1.618,66	508138	22x1,50x140	2.683,62
508031	10x1,25x060	200,10	508067	12x1,50x130	619,24	508103	18x1,50x060	813,04	508143	24x2,00x080	2.073,92
508032	10x1,25x065	219,70	508068	12x1,50x140	655,34	508104	18x1,50x065	861,96	508144	24x2,00x090	2.238,22
508033	10x1,25x070	229,56	508069	12x1,50x150	694,66	508105	18x1,50x070	911,14	508145	24x2,00x100	2.408,14
508034	10x1,25x080	268,78	508070	14x1,50x045	344,06	508106	18x1,50x080	999,42	508146	24x2,00x110	2.683,62
508035	10x1,25x090	301,42	508071	14x1,50x050	360,46	508107	18x1,50x090	1.015,80			

DIN 912 métrica

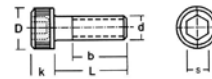

Ref. 8.8	€/ 100 8.8	Ref. 8.8 Zn	€/ 100 8.8 Zn	Ref. 10.9	€/ 100 10.9	Ref. A2	€/ 100 A2	Longitud mm
508212	11,60	521320	29,00					04x006
508213	11,86	521321	29,65	521531	12,54	521741	9,44	04x008
508214	12,40	521322	31,00	521532	13,78	521742	10,30	04x010
508215	12,46	521323	31,15	521533	14,10	521743	11,16	04x012
508217	12,58	521324	31,45	521534	14,70	521744	12,90	04x016
508219	14,04	521326	35,10	521536	16,32	521746	15,18	04x020
508221	16,44	521328	41,10	521538	17,42	521748	18,04	04x025
508222	18,18	521329	45,45	521539	21,84	521749	20,88	04x030
508223	24,54	521330	61,35	521540	24,98	521750	23,76	04x035
508224	27,22	521331	68,05	521541	28,22	521751	26,60	04x040
508235	13,10	521333	32,75	521543	15,62	521753	12,58	05x008
508236	13,28	521334	33,20	521544	15,76	521754	13,78	05x010
508237	13,66	521335	34,15	521545	16,62	521755	15,02	05x012
508239	15,52	521336	38,80	521546	19,40	521756	17,56	05x016
508241	16,92	521338	42,30	521548	21,64	521758	20,38	05x020
508243	18,00	521340	45,00	521550	24,00	521760	24,32	05x025
508244	18,36	521341	45,90	521551	26,60	521761	28,34	05x030
508245	23,56	521342	58,90	521552	32,68	521762	32,24	05x035
508246	27,36	521343	68,40	521553	36,46	521763	36,12	05x040
508247	30,16	521344	75,40	521554	40,44	521764	40,12	05x045
508248	32,90	521345	82,25	521555	44,14	521765	44,10	05x050
508264	22,20	521346	55,50					06x008
508265	22,56	521347	56,40	521557	17,60	521767	20,54	06x010
508266	13,20	521348	33,00	521558	17,66	521768	21,98	06x012
508268	15,08	521349	37,70	521559	17,86	521769	24,98	06x016
508270	17,00	521351	42,50	521561	19,66	521771	28,22	06x020
508272	19,24	521353	48,10	521563	22,52	521773	32,78	06x025
508273	21,84	521354	56,60	521564	25,80	521774	37,20	06x030
508274	24,50	521355	61,25	521565	29,02	521775	42,90	06x035
508275	27,22	521356	68,05	521566	32,50	521776	48,42	06x040
508276	30,66	521357	76,65	521567	35,78	521777	53,64	06x045
508277	35,62	521358	89,05	521568	39,68	521778	58,42	06x050
508278	43,56	521359	108,90	521569	47,20	521779	64,56	06x055
508279	46,34	521360	115,85	521570	50,42	521780	69,44	06x060
508280	50,86	521361	127,15	521571	61,82			06x065
508281	54,80	521362	137,00	521572	65,78	521782	83,78	06x070
508283	64,92	521364	162,30	521574	74,68	521784	98,22	06x080
508284	73,98	521365	184,95	521575	89,78	521785	116,28	06x090
508285	82,24	521366	205,60	521576	99,26	521786	128,28	06x100
508286	97,96	521367	244,90	521577	116,54			06x110
508287	123,04	521368	307,60	521578	136,74			06x120
508295	42,06	521369	105,15	521579	34,52	521789	49,92	08x012
508297	30,66	521370	76,65	521580	35,62	521790	53,22	08x016
508299	33,80	521372	84,50	521582	38,74	521792	58,84	08x020
508301	37,34	521374	93,35	521584	43,10	521794	64,88	08x025
508302	41,86	521375	104,65	521585	48,08	521795	73,12	08x030
508303	45,90	521376	114,75	521586	53,22	521796	81,74	08x035
508304	51,40	521377	128,50	521587	59,04	521797	90,42	08x040
508305	56,76	521378	141,90	521588	65,24	521798	99,04	08x045
508306	61,64	521379	154,10	521589	70,60	521799	107,70	08x050
508307	67,16	521380	167,90	521590	76,60	521800	119,76	08x055
508308	72,44	521381	181,10	521591	82,60	521801	128,68	08x060
508309	82,78	521382	206,95	521592	102,44			08x065
508310	100,76	521383	251,90	521593	108,40	521803	151,12	08x070
508312	112,82	521385	282,05	521595	120,44	521805	169,42	08x080
508313	124,56	521386	311,40	521596	134,14	521806	192,98	08x090
508314	138,30	521387	345,75	521597	148,14	521807	217,54	08x100
508315	204,20	521388	510,50	521598	216,98	521808	249,34	08x110
508316	230,18	521389	575,45	521599	255,78	521809	283,14	08x120
508317	286,44	521390	716,10	521600	311,48			08x130

Ref. 8.8	€/ 100 8.8	Ref. 8.8 Zn	€/ 100 8.8 Zn	Ref. 10.9	€/ 100 10.9	Ref. A2	€/ 100 A2	Longitud mm
508318	291,20	521391	728,00	521601	322,34			08x140
508319	325,08	521392	812,70	521602	343,92			08x150
508326	52,96	521393	132,40	521603	66,54	521813	93,08	10x016
508328	57,30	521395	143,25	521605	66,62	521815	99,04	10x020
508330	63,76	521397	159,40	521607	73,74	521817	109,82	10x025
508331	69,88	521398	174,70	521608	80,92	521818	120,70	10x030
508332	76,34	521399	190,85	521609	88,74	521819	131,46	10x035
508333	85,08	521400	212,70	521610	97,86	521820	142,32	10x040
508334	94,20	521401	235,50	521611	107,46	521821	156,16	10x045
508335	100,86	521402	252,15	521612	116,58	521822	169,96	10x050
508336	110,64	521403	276,60	521613	127,74	521823	183,80	10x055
508337	117,20	521404	293,00	521614	138,66	521824	197,62	10x060
508338	126,64	521405	316,60	521615	154,24			10x065
508339	132,34	521406	330,85	521616	163,20	521826	225,36	10x070
508341	160,24	521408	400,60	521618	195,16	521828	267,88	10x080
508342	192,04	521409	480,10	521619	228,00	521829	297,20	10x090
508343	211,82	521410	529,55	521620	251,52	521830	326,98	10x100
508344	231,42	521411	578,55	521621	274,76	521831	364,76	10x110
508345	249,28	521412	623,20	521622	295,96	521832	405,06	10x120
508346	288,52	521413	721,30	521623	342,60	521833	446,96	10x130
508347	308,70	521414	771,75	521624	366,50	521834	491,02	10x140
508348	325,14	521415	812,85	521625	386,00	521835	535,58	10x150
508358	101,58	521416	253,95	521626	104,72	521836	142,92	12x020
508359	92,72	521417	231,80	521627	108,84	521837	154,42	12x025
508360	102,38	521418	255,95	521628	121,74	521838	170,40	12x030
508361	113,10	521419	282,75	521629	132,50	521839	185,54	12x035
508362	120,98	521420	302,45	521630	141,68	521840	201,12	12x040
508363	132,76	521421	331,90	521631	156,16	521841	216,68	12x045
508364	142,68	521422	356,70	521632	168,56	521842	235,70	12x050
508365	154,90	521423	387,25	521633	180,62	521843	254,74	12x055
508366	174,08	521424	435,20	521634	196,32	521844	274,22	12x060
508367	179,28	521425	448,20	521635	210,02			12x065
508368	188,26	521426	470,65	521636	222,74	521846	317,44	12x070
508370	218,42	521428	546,05	521638	247,78	521848	367,26	12x080
508371	262,80	521429	657,00	521639	311,48	521849	408,02	12x090
508372	288,28	521430	720,70	521640	343,28	521850	448,76	12x100
508373	330,28	521431	825,70	521641	373,44	521851	503,56	12x110
508374	347,56	521432	868,90	521642	399,24	521852	560,72	12x120
508375	408,66	521433	1.021,65	521643	426,58	521853	620,10	12x130
508376	444,18	521434	1.110,45	521644	463,64	521854	686,86	12x140
508377	468,36	521435	1.170,90	521645	487,44	521855	745,82	12x150
508378	702,00	521436	1.755,00	521646	714,50			12x160
508380	774,44	521438	1.936,10	521648	788,16			12x180
508382	910,36	521440	2.275,90	521650	975,18			12x200
508417	217,68	521441	544,20			521861	408,18	16x025
508418	224,88	521442	562,20	521652	248,44	521862	371,12	16x030
508419	241,60	521443	604,00	521653	266,90	521863	402,56	16x035
508420	262,80	521444	657,00	521654	287,72	521864	434,08	16x040
508421	275,70	521445	689,25	521655	304,60	521865	465,58	16x045
508422	299,78	521446	749,45	521656	331,18	521866	505,64	16x050
508423	318,18	521447	795,45	521657	351,52	521867	543,76	16x055
508424	341,56	521448	853,90	521658	377,42	521868	581,96	16x060
508425	365,56	521449	913,90	521659	403,94			16x065
508426	388,80	521450	972,00	521660	429,60	521870	658,24	16x070
508428	429,54	521452	1.073,85	521662	474,64	521872	755,58	16x080
508429	468,06	521453	1.170,15	521663	517,16	521873	857,22	16x090
508430	594,30	521454	1.485,75	521664	574,60	521874	937,90	16x100
5								

DIN 912 métrica



Ref. 8.8	€/100 8.8	Ref. 8.8 Zn	€/100 8.8 Zn	Ref. 10.9	€/100 10.9	Ref. A2	€/100 A2	Longitud mm
508434	851,32	521458	2.128,30	521668	866,40	521878	1.396,90	16x140
508435	902,26	521459	2.255,65	521669	918,20	521879	1.522,62	16x150
508436	989,98	521460	2.474,95	521670	1.143,46			16x160
508438	1.099,12	521462	2.747,80	521672	1.269,48			16x180
508440	1.207,52	521464	3.018,80	521674	1.394,66			16x200
508477	361,04	521465	902,60	521675	536,96	521885	1.087,56	20x040
508478	571,24	521466	1.428,10	521676	578,86	521886	1.167,32	20x045
508479	600,54	521467	1.501,35	521677	615,88	521887	1.247,10	20x050
508480	633,54	521468	1.583,85	521678	644,72	521888	1.326,84	20x055
508481	674,06	521469	1.685,15	521679	686,04	521889	1.413,82	20x060
508482	725,72	521470	1.814,30	521680	738,56			20x065
508483	746,66	521471	1.866,65	521681	759,88	521891	1.580,56	20x070
508485	838,18	521473	2.095,45	521683	853,00	521893	1.793,32	20x080
508487	926,74	521475	2.316,85	521685	943,18	521895	2.030,10	20x090
508489	984,62	521477	2.461,55	521687	1.002,02	521897	2.220,90	20x100
508490	1.128,64	521478	2.821,60	521688	1.148,62	521898	2.532,30	20x110
508491	1.207,86	521479	3.019,65	521689	1.229,18	521899	2.732,66	20x120
508492	1.397,90	521480	3.494,75	521690	1.422,64	521900	3.002,82	20x130
508493	1.484,42	521481	3.711,05	521691	1.510,70	521901	3.282,50	20x140
508494	1.575,36	521482	3.938,40	521692	1.603,26	521902	3.571,78	20x150
508495	1.741,04	521483	4.352,60	521693	1.687,48			20x160
508497	2.047,26	521485	5.118,15	521695	2.367,58			20x180
508499	2.226,58	521487	5.566,45	521697	2.575,04			20x200
				521698	1.353,50			24x050
				521699	1.356,08			24x055
				521700	1.364,92			24x060
				521701	1.421,22			24x065

Ref. 8.8	€/100 8.8	Ref. 8.8 Zn	€/100 8.8 Zn	Ref. 10.9	€/100 10.9	Ref. A2	€/100 A2	Longitud mm
				521702	1.475,04			24x070
				521704	1.633,04			24x080
				521706	1.700,28			24x090
				521707	1.943,58			24x100
				521708	2.062,50			24x110
				521709	2.204,52			24x120
				521710	2.546,66			24x130
				521711	2.690,58			24x140
				521712	2.847,14			24x150
				521713	3.271,84			24x160
				521715	3.625,90			24x180
				521717	3.979,06			24x200
				521718	2.750,46			30x060
				521719	2.929,56			30x065
				521720	2.987,58			30x070
				521722	3.224,70			30x080
				521723	3.414,40			30x090
				521724	3.714,10			30x100
				521725	4.450,84			30x110
				521726	4.737,70			30x120
				521727	5.019,14			30x130
				521728	5.303,30			30x140
				521729	5.576,88			30x150
				521730	6.259,74			30x160
				521732	6.942,58			30x180
				521734	7.511,64			30x200

DIN 7984 cabeza rebajada. 8.8

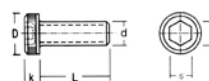

Ref. 8.8	Longitud mm	€/100 8.8
509600	03x006	17,86
509601	03x008	18,48
509602	03x010	19,65
509603	03x012	20,32
509604	03x016	21,96
509605	03x020	22,44
509606	03x025	33,26
509607	03x030	40,50
509608	04x006	16,92
509609	04x008	17,88
509610	04x010	18,96
509611	04x012	19,56
509612	04x016	20,54
509613	04x020	21,58
509614	04x025	22,44
509615	04x030	27,48
509616	04x035	32,50
509617	04x040	37,08
509618	05x008	18,30
509619	05x010	19,65
509620	05x012	20,32
509621	05x016	21,65
509622	05x020	22,01
509623	05x025	23,65

Ref. 8.8	Longitud mm	€/100 8.8
509624	05x030	26,08
509625	05x035	32,74
509626	05x040	37,54
509627	05x045	41,22
509628	05x050	62,92
509629	06x008	17,85
509630	06x010	18,78
509631	06x012	19,88
509632	06x016	20,16
509633	06x020	22,20
509634	06x025	27,22
509635	06x030	32,26
509636	06x035	34,56
509637	06x040	38,66
509638	06x045	47,84
509639	06x050	59,08
509640	06x055	72,08
509641	06x060	83,54
509642	08x010	38,85
509643	08x012	39,85
509644	08x016	41,25
509645	08x020	43,65
509646	08x025	44,85
509647	08x030	46,85

Ref. 8.8	Longitud mm	€/100 8.8
509648	08x035	51,94
509649	08x040	65,24
509650	08x045	78,26
509651	08x050	89,46
509652	08x055	103,42
509653	08x060	113,28
509654	08x070	143,02
509655	10x016	76,88
509656	10x020	71,86
509657	10x025	73,22
509658	10x030	78,06
509659	10x035	80,32
509660	10x040	86,26
509661	10x045	92,02
509662	10x050	102,78
509663	10x055	127,24
509664	10x060	142,36
509665	10x070	194,50
509666	10x080	251,50
509667	10x090	355,40
509668	10x100	456,48
509669	12x020	108,50
509670	12x025	102,98
509671	12x030	110,76

Ref. 8.8	Longitud mm	€/100 8.8
509672	12x035	114,58
509673	12x040	122,00
509674	12x045	149,60
509675	12x050	160,68
509676	12x055	189,48
509677	12x060	221,08
509678	12x070	273,26
509679	12x080	346,00
509680	12x090	456,48
509681	12x100	557,98
509682	16x025	623,64
509683	16x030	296,14
509684	16x035	317,88
509685	16x040	338,44
509686	16x045	359,98
509687	16x050	381,04
509688	16x055	423,46
509689	16x060	465,64
509690	16x070	552,00
509691	16x080	632,78
509692	16x090	1.131,02
509693	16x100	1.425,56

DIN 7991 métrica

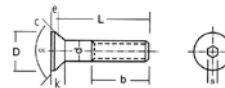

Ref. 10.9	€/100 10.9	Ref. Zn	€/100 Zn	Ref. A2	€/100 A2	Longitud mm
				522050	31,20	03x006
509701	16,88	504750	18,54	522051	3,54	03x008
509702	16,12	504751	17,82	522052	3,84	03x010
509703	16,88	504752	18,54	522053	3,98	03x012
509705	17,60	504753	19,30	522055	5,10	03x016
509707	19,56	504754	21,48	522057	7,98	03x020
509708	21,14	504755	23,50	522058	9,80	03x025
509709	22,70	504756	25,20	522059	11,06	03x030
				522062	60,80	04x006
				522063	6,26	04x008
509713	18,30			522064	6,58	04x010
509714	12,30	504757	13,52	522065	7,60	04x012
509715	12,80	504758	13,94	522067	8,74	04x016
509717	13,20	504759	14,70	522069	10,06	04x020
509719	13,94	504760	15,94	522070	12,14	04x025
509720	15,36	504761	17,60	522071	15,80	04x030
509721	18,30	504762	21,22	522072	18,54	04x035
509722	20,98	504763	24,80	522073	21,26	04x040
509723	24,80	504764	28,92	522074	24,00	04x045
509724	42,18	504765	46,56	522075	26,72	04x050
509725	48,08			522079	10,92	05x008
509729	12,80	504766	14,70	522080	11,36	05x010
509730	12,80	504767	14,70	522081	11,46	05x012
509731	13,20	504768	15,36	522083	14,14	05x016
509733	13,52	504769	16,38	522085	16,88	05x020
509735	14,70	504770	18,10	522086	20,22	05x025
509736	15,94	504771	19,56	522087	23,60	05x030
509737	19,56	504772	23,82	522088	29,56	05x035
509738	23,12	504773	28,92	522089	33,80	05x040
509739	27,66	504774	34,24	522090	38,02	05x045
509740	35,46	504775	44,96	522091	42,18	05x050
509741	45,78	504776	54,22	522095	149,60	06x008
				522096	15,44	06x010
509746	17,36	504777	19,78	522097	16,32	06x012
509747	16,62	504778	19,30	522099	22,70	06x016
509749	15,36	504779	18,80	522101	31,64	06x020
509751	16,12	504780	20,60	522102	36,16	06x025
509752	17,36	504781	21,98	522103	44,96	06x030
509753	20,22	504782	25,80	522104	50,50	06x035
509754	24,06	504783	30,06	522105	56,00	06x040
509755	27,66	504784	34,66	522106	61,52	06x045
509756	33,72	504785	41,42	522107	67,02	06x050
509757	41,18	504786	49,60	522108	78,08	06x055
509758	53,46	504787	62,90	522109	78,08	06x060
509759	65,72	504788	76,10	522110	81,48	06x070
509760	90,30	504789	102,84	522111	81,48	06x080
509761	101,02	504790	112,82	522112	92,18	06x090
509762	118,12	504791	126,98	522113	106,36	06x100
509763	127,42	504792	141,62	522114	347,80	08x010
				522115	35,90	08x012
509765	27,66	504793	34,42	522117	47,06	08x016
509767	27,66	504794	34,42	522119	62,50	08x020
509769	28,42	504795	36,40	522120	71,08	08x025
509770	29,90	504796	39,50	522121	79,06	08x030
509771	33,00	504797	43,84	522122	92,72	08x035
509772	36,66	504798	48,94	522123	106,28	08x040
509773	41,18	504799	54,96	522124	119,94	08x045
509774	45,78	504800	60,98	522125	132,50	08x050
509775	50,10	504801	66,72	522126	158,68	08x055
509776	64,04	504802	83,86	522127	158,68	08x060
509777	77,82	504803	97,04	522128	184,84	08x070
509778	94,52	504804	117,76	522129	184,84	08x080
509779	123,26	504805	149,08	522130	211,02	08x090
509780	193,18	504806	221,80	522131	237,18	08x100
509781	287,62	504807	319,36			08x110
509782	433,70					08x120
509783	508,38					10x016
509786	70,10	504808	79,50	522136	76,96	10x020
509788	50,10	504809	61,90	522138	80,76	10x025
509789	52,28	504810	65,72	522139	88,68	10x030
509790	53,96	504811	69,66	522140	102,08	

Ref. 10.9	€/100 10.9	Ref. Zn	€/100 Zn	Ref. A2	€/100 A2	Longitud mm
509791	59,22	504812	77,10	522141	115,38	10x035
509792	65,06	504813	84,78	522142	128,72	10x040
509793	71,08	504814	92,96	522143	144,80	10x045
509794	80,42	504815	104,58	522144	160,78	10x050
509795	91,28	504816	118,24	522145	175,76	10x055
509796	114,40	504817	142,32	522146	190,74	10x060
509797	136,82	504818	170,96	522147	220,14	10x070
509798	185,00	504819	226,40	522148	249,48	10x080
509799	258,90	504820	305,58	522149	278,86	10x090
509800	328,46	504821	380,04	522150	308,26	10x100
509801	585,36	504822	650,42			10x110
509802	636,98	504823	707,80			10x120
509805	109,82	504824	127,20	522155	121,34	12x020
509806	110,52	504825	131,28	522156	132,50	12x025
509807	111,26	504826	136,56	522157	152,24	12x030
509808	113,26	504827	139,96	522158	171,52	12x035
509809	115,84	504828	147,14	522159	190,74	12x040
509810	123,26	504829	155,82	522160	210,24	12x045
509811	131,50	504830	168,56	522161	229,74	12x050
509812	146,22	504831	185,00	522162	259,10	12x055
509813	164,26	504832	198,44	522163	288,48	12x060
509814	180,62	504833	232,86	522164	360,04	12x065
509815	180,62	504834	232,86	522165	411,00	12x070
509816	246,36	504835	308,02	522166	461,92	12x080
509817	591,58	504836	709,88	522167	512,90	12x090
509818	591,58	504837	851,82			12x100
509819	892,34	504838	1.101,60			12x110
509820	1.020,38	504839	1.259,76			12x120
509822	209,80	504840	241,28			14x030
509823	220,56	504841	255,98			14x035
509824	230,68	504842	270,42			14x040
509825	246,36	504843	305,90			14x045
509826	262,32	504844	310,68			14x050
509827	283,22	504845	335,48			14x055
509828	304,48	504846	360,54			14x060
509829	440,46	504847	505,08			14x070
509830	590,54	504848	663,26			14x080
509831	828,16	504849	1.035,22			14x090
509832	946,48	504850	1.183,10			14x100
				522183	4.312,40	16x025
509834	209,80	504851	252,90	522184	494,16	16x030
509835	220,56	504852	269,02	522185	517,34	16x035
509836	230,68	504853	284,70	522186	558,98	16x040
509837	246,36	504854	305,90	522187	641,08	16x045
509838	262,32	504855	327,54	522188	641,08	16x050
509839	283,22	504856	353,76	522189	695,44	16x055
509840	304,48	504857	380,30	522190	749,82	16x060
509841	440,46	504858	506,94	522191	983,30	16x070
509842	590,54	504859	690,98	522192	1.211,58	16x080
509843	828,16	504860	1.035,22	522193	1.364,22	16x090
509844	946,48	504861	1.183,10	522194	1.516,90	16x100
509845	1.164,86	504862	1.397,84			16x110
509846	1.183,10	504863	1.419,74			16x120
509847	1.460,04	504864	1.752,04			16x130
509848	1.607,60	504865	1.929,14			16x140
509849	1.755,18	504866	2.106,24			16x150
509857	628,08	504867	712,60	522207	11.677,20	20x040
509858	651,46	504868	744,92	522208	12.593,20	20x045
509859	675,30	504869	777,16	522209	14.081,40	20x050
509860	698,68	504870	809,74	522210	14.997,00	20x055
509861	736,48	504871	855,20	522211	16.370,60	20x060
509862	798,14	504872	933,92	522212	18.774,60	20x070
509863	944,04	504873	1.098,70	522213	22.896,20	20x080
509864	1.656,30	504874	2.070,38	522214	25.872,60	20x090
509865	1.892,94	504875	2.366,18	522215	28.963,80	20x100
509866	2.324,42	504876	2.789,36			20x110
509867	2.366,18	504877	2.839,46			20x120
509868	2.746,10	504878	3.295,34			20x130
509869	2.956,92	504879	3.548,36			20x140
509870	3.125,62	504880	3.750,76			20x150

06



ISO 7380 métrica

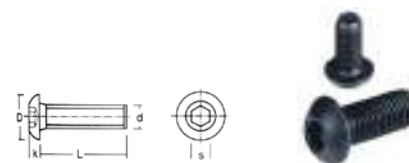

Ref. 10.9	€/ 100 10.9	Ref. A2	€/ 100 A2	Longitud mm	Ref. 10.9	€/ 100 10.9	Ref. A2	€/ 100 A2	Longitud mm	Ref. 10.9	€/ 100 10.9	Ref. A2	€/ 100 A2	Longitud mm
509901	32,50			03x008	509933	34,78			05x045	509964	104,42			08x055
509902	18,54			03x010	509934	46,44			05x050	509965	127,56			08x060
509903	18,54			03x012	509935	24,36			06x008	509966	185,58			08x070
509905	19,74			03x016	509936	23,22	522286	70,36	06x010	509967	92,76	522317	310,57	10x016
509906	20,88			03x020	509937	23,22	522287	74,32	06x012	509969	69,60	522319	334,06	10x020
509907	22,08			03x025	509939	24,36	522289	75,52	06x016	509970	71,94	522320	365,03	10x025
509908	23,28			03x030	509941	25,56	522291	84,72	06x020	509971	76,60	522321	385,97	10x030
509910	20,88	522260	36,52	04x008	509943	26,72	522293	97,72	06x025	509972	85,88	522322	419,44	10x035
509911	18,54	522261	35,20	04x010	509944	28,96	522294	109,40	06x030	509973	92,76	522323	447,83	10x040
509912	18,54	522262	39,12	04x012	509945	32,50	522295	123,80	06x035	509974	104,42	522324	497,31	10x045
509914	19,74	522264	39,12	04x016	509946	34,78	522296	144,60	06x040	509975	116,04	522325	561,68	10x050
509915	20,88	522265	44,24	04x020	509947	41,80	522297	170,68	06x045	509976	127,56	522326	600,06	10x055
509917	22,08	522267	50,84	04x025	509948	69,60	522298	190,12	06x050	509977	139,20	522327	679,21	10x060
509918	23,22	522268	65,12	04x030	509949	81,26			06x055	509979	174,02			10x070
509919	30,06	522269	78,16	04x035	509950	92,76			06x060	509980	150,80			12x020
509920	31,20	522270	91,16	04x040	509951	34,78			08x010	509981	139,20			12x025
509921	19,74	522271	46,92	05x008	509952	32,50			08x012	509982	150,80			12x030
509922	18,54	522272	50,84	05x010	509954	32,50	522304	149,80	08x016	509983	162,42			12x035
509923	18,54	522273	50,84	05x012	509956	34,78	522306	166,68	08x020	509984	174,02			12x040
509925	19,74	522275	54,72	05x016	509958	39,44	522308	184,92	08x025	509985	185,58			12x045
509927	20,88	522277	59,92	05x020	509959	41,80	522309	214,92	08x030	509986	197,18			12x050
509929	22,08	522279	71,72	05x025	509960	46,44	522310	242,20	08x035	509987	208,80			12x055
509930	23,22	522280	91,16	05x030	509961	57,98	522311	272,24	08x040	509988	220,40			12x060
509931	25,56	522281	104,16	05x035	509962	81,26	522312	298,28	08x045	509990	255,20			12x070
509932	30,16	522282	123,80	05x040	509963	81,26	522313	321,71	08x050					

DIN 913 espárrago allen punta plana

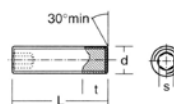

Ref. 45 H	€/ 100 45 H	Ref. A2	€/ 100 A2	Medida mm	Ref. 45 H	€/ 100 45 H	Ref. A2	€/ 100 A2	Medida mm	Ref. 45 H	€/ 100 45 H	Ref. A2	€/ 100 A2	Medida mm
520000	5,50	522350	31,00	2x3	510013	13,70	522410	25,00	6x30	520069	198,00			12x100
520001	6,30	522351	32,00	2x4	510014	16,40	522411	27,00	6x35	520070	26,60			14x12
520002	6,40	522352	33,00	2x5	520044	18,40	522412	30,00	6x40	520071	36,80			14x14
520003	4,90	522353	35,00	2x6	520045	21,80	522413	32,00	6x45	520072	40,20			14x16
520004	5,00	522354	40,00	2x8	520046	23,90	522414	36,00	6x50	520073	51,80			14x20
520005	6,80	522355	44,00	2x10	520047	25,90			6x55	520074	62,00			14x25
520006	5,60	522356	24,00	2,5x3	520048	28,00	522416	46,00	6x60	520075	81,70			14x30
520007	5,70	522357	24,75	2,5x4	520049	3,60			8x6	520076	74,00			14x35
520008	5,80	522358	25,50	2,5x5	510015	5,20	522418	10,00	8x8	520077	112,00			14x40
520009	5,90	522359	27,00	2,5x6	510016	6,40	522419	11,00	8x10	520078	118,00			14x45
520010	6,00	522360	31,00	2,5x8	510017	8,30	522420	14,00	8x12	520079	130,00			14x50
520011	6,40	522361	33,00	2,5x10	510018	9,50			8x14	520080	168,00			14x55
520012	6,50	522362	36,50	2,5x12	510059	11,60	522422	19,00	8x16	520081	184,00			14x60
520013	2,90	522363	5,80	3x3	510019	14,60	522423	30,00	8x20	520082	218,00			14x70
520014	3,00	522364	6,00	3x4	510020	20,00	522424	38,00	8x25	520083	256,00			14x80
520015	3,30	522365	6,20	3x5	510021	23,90	522425	50,00	8x30	520084	287,00			14x90
520016	3,40	522366	6,40	3x6	510022	28,60	522426	60,00	8x35	520085	313,00			14x100
520017	3,60	522367	6,50	3x8	510023	32,00	522427	70,00	8x40	520086	81,00			16x12
520018	4,10	522368	6,90	3x10	520050	38,00	522428	80,00	8x45	510045	82,00			16x14
520019	4,50	522369	8,90	3x12	520051	42,30	522429	95,00	8x50	510062	83,00			16x16
520020	5,90	522370	11,00	3x16	520052	47,00			8x55	510046	84,00			16x20
520021	9,40	522371	14,00	3x20	520053	51,10			8x60	510047	85,00			16x25
520022	12,00			3x25	520054	60,00			8x70	510048	101,00			16x30
520023	13,70			3x30	520055	70,20			8x80	510049	120,00			16x35
520024	2,90			4x3	520056	80,00			8x90	510050	139,00			16x40
520025	3,00	522375	3,80	4x4	520057	90,00			8x100	510051	158,00			16x45
520026	3,10	522376	4,00	4x5	520058	8,90			10x8	510052	181,00			16x50
520027	3,20	522377	5,00	4x6	510024	10,00	522437	19,00	10x10	510053	203,00			16x55
520028	3,30	522378	6,00	4x8	510025	13,30	522438	21,00	10x12	510054	218,00			16x60
520029	3,40	522379	7,00	4x10	510026	15,00			10x14	510055	249,00			16x70
520030	4,40	522380	8,00	4x12	510060	19,20	522440	24,00	10x16	520087	286,00			16x80
520031	5,90	522381	10,00	4x16	510027	24,50	522441	39,00	10x20	520088	293,00			16x90
520032	7,40	522382	12,00	4x20	510028	30,00	522442	42,00	10x25	520089	371,00			16x100
520033	10,90	522383	14,00	4x25	510029	35,00	522443	47,00	10x30	520103	102,00			20x20
520034	15,20	522384	18,00	4x30	510030	38,00	522444	63,00	10x35	520104	113,00			20x25
520035	17,40			4x35	510031	45,60	522445	72,00	10x40	520105	170,00			20x30
520036	18,60			4x40	510032	56,80	522446	82,00	10x45	520106	211,00			20x35
520037	3,50			5x4	510033	60,90	522447	95,00	10x50	520107	239,00			20x40
520038	3,60	522388	4,00	5x5	520059	77,00			10x55	520108	232,00			20x45
510000	3,70	522389	5,00	5x6	520060	80,40	522449	145,00	10x60	520109	320,00			20x50
510001	3,80	522390	6,00	5x8	520061	94,00	522450	165,00	10x70	520110	333,00			20x55
510002	3,90	522391	8,00	5x10	520062	109,00			10x80	520111	388,00			20x60
510003	4,00	522392	10,00	5x12	520063	128,00			10x90	520112	368,00			20x70
510004	5,70			5x14	520064	135,00			10x100	520113	440,00			20x80
510056	6,00	522394	12,00	5x16	520065	11,30			12x10	520114	515,00			20x90
510005	6,60	522395	14,00	5x20	510034	19,10			12x12	520115	702,00			20x100
510057	9,60	522396	16,00	5x25	510035	23,50			12x14	520118	986,00			22x35
520039	13,50	522397	18,00	5x30	510061	27,30			12x16	520119	1.011,00			22x40
520040	15,70	522398	23,00	5x35	510036	33,80			12x20	520121	1.100,00			22x50
520041	18,40	522399	30,00	5x40	510037	45,70			12x25	520122	1.137,00			22x55
520042	19,50			5x45	510038	48,80			12x30	520127	844,00			24x25
520043	3,40	522401	6,00	6x5	510039	53,00			12x35	520128	865,00			24x30
510006	3,50	522402	7,00	6x6	510040	58,20			12x40	520129	900,00			24x35
510007	3,60	522403	8,00	6x8	510041	79,60			12x45	520130	1.030,00			24x40
510008	3,70	522404	10,00	6x10	510042	82,20			12x50	520131	1.050,00			24x45
510009	3,80	522405	12,00	6x12	510043	97,40			12x55	520132	1.100,00			24x50
510010	5,40			6x14	510044	115,80			12x60	520133	1.150,00			24x55
510058	6,60	522407	14,00	6x16	520066	136,00			12x70	520134	1.200,00			24x60
510011	8,30	522408	16,00	6x20	520067	156,00			12x80	520135	1.300,00			24x70
510012	10,90	522409	18,00	6x25	520068	165,00			12x90	520136	1.400,00			24x80

06



DIN 914 espárrago allen punta cónica

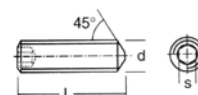

Ref. 45 H	€/ 100 45 H	Ref. A2	€/ 100 A2	Medida mm	Ref. 45 H	€/ 100 45 H	Ref. A2	€/ 100 A2	Medida mm	Ref. 45 H	€/ 100 45 H	Ref. A2	€/ 100 A2	Medida mm
510100	8,90	522550	46,00	2x3	510158	20,80	522608	71,60	6x40	510211	41,00			14x16
510101	10,70	522551	32,00	2x4	510159	23,00	522609	14,00	6x45	510212	52,84			14x20
510102	10,80	522552	35,50	2x5	510160	25,70	522610	23,00	6x50	510213	63,24			14x25
510103	10,90	522553	35,60	2x6	510161	29,00	522611	25,00	6x55	510214	83,33			14x30
510104	10,95	522554	36,00	2x8	510162	33,40	522612	29,00	6x60	510215	82,00			14x35
510105	11,00	522555	38,00	2x10	510238	423,00			6x100	510216	114,24			14x40
510113	6,30	522563	11,50	3x3	510163	5,80	522613	34,00	8x8	510217	128,00			14x45
510114	6,40	522564	12,00	3x4	510164	8,20	522614	44,00	8x10	510218	132,00			14x50
510115	6,50	522565	12,50	3x5	510165	9,90	522615	60,00	8x12	510219	171,36			14x55
510116	6,60	522566	16,00	3x6	510166	13,10	522616	70,00	8x16	510220	187,68			14x60
510117	6,70	522567	17,00	3x8	510167	19,50	522617	76,00	8x20	510221	222,36			14x70
510118	6,80	522568	18,00	3x10	510168	23,00	522618	80,00	8x25	510222	261,12			14x80
510119	8,20	522569	19,00	3x12	510169	27,50	522619	90,00	8x30	510223	292,74			14x90
510120	11,90	522570	21,00	3x16	510170	33,00	522620	28,00	8x35	510225	84,66			16x16
510121	12,80	522571	23,00	3x20	510171	35,00	522621	45,00	8x40	510226	85,68			16x20
510122	12,50	522572	13,00	3x25	510172	39,00	522622	53,00	8x45	510227	86,70			16x25
510123	20,40	522573	13,50	3x30	510173	48,00	522623	62,00	8x50	510228	103,02			16x30
510124	3,90	522574	14,00	4x4	510174	49,00	522624	69,00	8x55	510229	122,40			16x35
510125	5,60	522575	15,00	4x5	510175	52,12	522625	95,00	8x60	510230	141,78			16x40
510126	3,90	522576	12,00	4x6	510176	61,20	522626	105,00	8x70	510231	161,16			16x45
510127	4,70	522577	13,00	4x8	510177	71,60	522627	178,95	8x80	510232	164,62			16x50
510128	5,30	522578	15,00	4x10	510178	81,60	522628	195,40	8x90	510233	207,06			16x55
510129	5,40	522579	19,00	4x12	510179	91,80	522629	37,75	8x100	510234	222,36			16x60
510130	6,30	522580	31,00	4x16	510180	10,40	522630	42,00	10x10	510235	292,00			16x70
510131	9,60	522581	41,00	4x20	510181	11,50	522631	28,50	10x12	510236	300,00			16x80
510132	17,00	522582	43,00	4x25	510182	19,58	522632	29,00	10x16	510237	311,00			16x90
510133	19,50	522583	45,94	4x30	510183	24,99	522633	29,50	10x20	510239	89,00			20x20
510134	22,00	522584	9,00	4x35	510184	30,60	522634	30,50	10x25	510240	117,00			20x25
510135	23,50	522585	10,00	4x40	510185	42,70	522635	35,00	10x30	510241	145,00			20x30
510106	9,30	522556	43,00	5x3	510186	38,20			10x35	510242	175,00			20x35
510107	9,40	522557	13,00	5x4	510187	58,10			10x40	510243	245,00			20x40
510136	3,90			5x5	510188	66,80			10x45	510244	290,00			20x45
510137	4,60			5x6	510189	70,00			10x50	510245	354,00			20x50
510138	5,80			5x8	510190	78,54			10x55	510246	358,00			20x55
510139	6,40			5x10	510191	82,01			10x60	510247	360,00			20x60
510140	6,80			5x12	510192	95,88			10x70	510248	380,00			20x70
510141	8,90	522591	32,20	5x16	510193	111,18			10x80	510249	504,00			20x80
510142	13,00	522592	43,00	5x20	510194	130,56			10x90	510250	586,00			20x90
510143	15,40	522593	46,00	5x25	510195	137,70			10x100	510251	600,00			20x100
510144	18,90	522594	49,00	5x30	510196	11,60			12x12	510252	126,00			24x25
510145	21,00	522595	58,00	5x35	510197	29,70			12x16	510253	137,00			24x30
510146	23,80	522596	60,00	5x40	510198	38,50			12x20	510254	212,00			24x35
510147	25,00	522597	11,00	5x45	510199	46,00			12x25	510255	229,00			24x40
510148	27,00	522598	12,00	5x50	510200	53,00			12x30	510256	300,00			24x45
510149	5,10	522599	16,00	6x6	510201	59,00			12x35	510257	325,00			24x50
510150	5,20	522600	18,00	6x8	510202	62,00			12x40	510258	350,00			24x55
510151	5,50	522601	22,00	6x10	510203	81,19			12x45	510259	377,00			24x60
510152	5,80	522602	36,00	6x12	510204	107,00			12x50	510260	503,90			24x70
510153	9,50	522603	38,00	6x16	510205	110,00			12x55	510261	517,00			24x80
510154	11,10	522604	42,00	6x20	510206	118,12			12x60	510262	624,59			24x90
510155	12,30	522605	44,00	6x25	510207	138,72			12x70	510263	750,00			24x100
510156	14,40	522606	47,00	6x30	510208	159,12			12x80					
510157	17,20	522607	50,00	6x35	510209	168,30			12x90					

DIN 915 espárrago allen con pivote. 45 H

MIKALOR

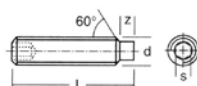

Ref. 45 H	Medida mm	€/ 100 45 H	Ref. 45 H	Medida mm	€/ 100 45 H	Ref. 45 H	Medida mm	€/ 100 45 H	Ref. 45 H	Medida mm	€/ 100 45 H
510300	2x3	30,00	510346	5x40	25,17	510387	10x40	59,84	510429	16x35	126,07
510301	2x4	32,00	510347	5x45	25,75	510388	10x45	68,80	510430	16x40	146,03
510302	2x5	34,00	510348	5x50	27,81	510389	10x50	72,10	510431	16x45	179,00
510303	2x6	36,00	510349	6x6	7,65	510390	10x55	77,25	510432	16x50	185,00
510304	2x8	37,00	510350	6x8	7,76	510391	10x60	82,40	510433	16x55	213,27
510305	2x10	49,00	510351	6x10	7,88	510392	10x70	98,76	510434	16x60	225,00
510313	3x3	6,49	510352	6x12	9,50	510393	10x80	114,52	510435	16x70	300,76
510314	3x4	6,59	510353	6x16	13,79	510394	10x90	134,48	510436	16x80	309,00
510315	3x5	6,70	510354	6x20	14,83	510395	10x100	141,83	510437	16x90	320,33
510316	3x6	6,80	510355	6x25	14,48	510396	12x12	16,00	510438	16x100	435,69
510317	3x8	6,90	510356	6x30	23,64	510397	12x16	31,00	510439	20x20	95,00
510318	3x10	7,00	510357	6x35	24,51	510398	12x20	39,66	510440	20x25	135,00
510319	3x12	8,45	510358	6x40	26,18	510399	12x25	47,38	510441	20x30	166,00
510320	3x16	12,26	510359	6x45	26,78	510400	12x30	63,00	510442	20x35	185,00
510321	3x20	13,18	510360	6x50	28,92	510401	12x35	64,00	510443	20x40	252,00
510322	3x25	12,88	510361	6x55	29,87	510402	12x40	66,00	510444	20x45	298,70
510323	3x30	21,01	510362	6x60	34,40	510403	12x45	97,00	510445	20x50	364,62
510324	4x4	4,02	510363	8x8	8,07	510404	12x50	110,21	510446	20x55	368,74
510325	4x5	7,10	510364	8x10	8,19	510405	12x55	113,30	510447	20x60	370,80
510326	4x6	7,07	510365	8x12	10,20	510406	12x60	115,36	510448	20x70	394,00
510327	4x8	7,18	510366	8x16	14,10	510407	12x70	117,42	510449	20x80	556,00
510328	4x10	7,28	510367	8x20	20,09	510408	12x80	128,75	510450	20x90	603,58
510329	4x12	8,78	510368	8x25	23,10	510409	12x90	147,29	510451	20x100	606,00
510330	4x16	12,75	510369	8x30	28,40	510410	12x100	159,65	510452	24x25	129,78
510331	4x20	13,71	510370	8x35	33,99	510411	14x16	32,96	510453	24x30	150,00
510332	4x25	13,39	510371	8x40	36,05	510412	14x20	49,44	510454	24x35	218,36
510333	4x30	21,85	510372	8x45	40,17	510413	14x25	65,14	510455	24x40	235,87
510334	4x35	22,66	510373	8x50	49,44	510414	14x30	85,83	510456	24x45	309,00
510335	4x40	24,21	510374	8x55	50,47	510415	14x35	109,00	510457	24x50	327,00
510336	5x5	7,38	510375	8x60	51,50	510416	14x40	120,00	510458	24x55	360,50
510337	5x6	7,35	510376	8x70	52,53	510417	14x45	143,00	510459	24x60	393,00
510338	5x8	7,46	510377	8x80	63,86	510418	14x50	160,00	510460	24x70	650,00
510311	5x10	26,00	510378	8x90	84,05	510420	14x60	193,31	510461	24x80	700,00
510339	5x10	7,58	510379	8x100	81,37	510421	14x70	229,03	510462	24x90	725,00
510312	5x12	27,50	510380	10x10	10,71	510422	14x80	268,95	510463	24x100	772,50
510340	5x12	9,14	510381	10x12	11,85	510423	14x90	301,52	510306	25x3	23,00
510341	5x16	13,26	510382	10x16	20,17	510424	14x100	340,00	510307	25x4	23,25
510342	5x20	14,26	510383	10x20	25,74	510425	16x16	44,29	510308	25x5	23,75
510343	5x25	13,93	510384	10x25	31,52	510426	16x20	64,89	510309	25x6	24,50
510344	5x30	22,73	510385	10x30	44,30	510427	16x25	92,00	510310	25x8	25,00
510345	5x35	23,57	510386	10x35	51,60	510428	16x30	106,11			

06



DIN 916 espárrago allen chaflán afilado

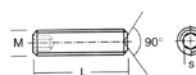

Ref. 45 H	€/100 45 H	Ref. A2	€/100 A2	Medida mm	Ref. 45 H	€/100 45 H	Ref. A2	€/100 A2	Medida mm	Ref. 45 H	€/100 45 H	Ref. A2	€/100 A2	Medida mm
520200	5,94	522900	44,88	2x3	510515	7,70	522952	13,26	8x10	520266	88,24	523004	73,03	14x30
520201	6,80	522901	61,20	2x4	510516	9,80	522953	15,05	8x12	520267	86,00	523005	75,95	14x35
520202	6,91	522902	71,40	2x5	510517	13,70	522954	18,36	8x16	520268	120,96	523006	78,99	14x40
520203	5,30	522903	77,52	2x6	510518	17,20	522955	27,54	8x20	520269	127,44	523007	82,15	14x45
520204	5,57	522904	81,60	2x8	510519	23,00			8x25	520270	130,00	523008	85,44	14x50
520205	7,34	522905	91,80	2x10	510520	26,00	522957	11,22	8x30	520271	181,44	523009	36,72	14x55
520206	6,05	522906	95,47	2,5x3	510521	32,00	522958	11,48	8x35	520272	198,72			14x60
520207	6,16	522907	99,29	2,5x4	510522	34,00	522959	11,73	8x40	520273	235,44			14x70
520208	6,26	522908	103,26	2,5x5	520236	41,04	522960	12,24	8x45	520274	258,00			14x80
520209	6,37	522909	107,39	2,5x6	520237	45,68	522961	12,75	8x50	520275	309,96			14x90
520210	6,48	522910	70,38	2,5x8	520238	50,76	522962	16,32	8x55	520276	338,04			14x100
520211	6,91	522911	96,90	2,5x10	520239	55,19	522963	17,34	8x60	520277	89,64			16x16
520212	7,02	522912	107,10	2,5x12	520240	64,80	522964	18,36	8x70	510537	90,72			16x20
520213	3,00	522913	182,53	3x3	520241	75,82	522965	19,38	8x80	510538	91,80			16x25
520214	3,20	522914	199,31	3x4	520242	86,40	522966	21,42	8x90	510539	109,08			16x30
520215	3,30	522915	150,00	3x5	520243	97,20	522967	23,46	8x100	510540	129,60			16x35
520216	3,80	522916	160,00	3x6	520244	9,61	522968	13,26	10x8	510541	150,12			16x40
520217	3,90	522917	165,00	3x8	510542	10,80	522969	13,77	10x10	520278	170,64			16x45
520218	4,60	522918	170,00	3x10	510524	14,36	522970	14,28	10x12	520279	195,48			16x50
520219	4,80	522919	100,78	3x12	510525	21,00	522971	15,30	10x16	520280	219,24			16x55
520220	6,70	522920	111,38	3x16	510526	26,46	522972	13,26	10x20	520281	235,44			16x60
520221	10,15	522921	189,83	3x20	510527	32,40	522973	15,30	10x25	520282	268,92			16x70
520222	13,20	522922	207,28	3x25	510528	40,00	522974	19,38	10x30	520283	308,88			16x80
520223	14,00	522923	165,00	3x30	510529	49,00	522975	31,62	10x35	520284	306,00			16x90
520224	3,10	522924	175,00	4x3	510530	54,00	522976	41,82	10x40	520285	400,68			16x100
520225	3,30	522925	180,00	4x4	520245	62,00	522977	43,86	10x45	520286	95,00			20x20
520226	3,50	522926	190,00	4x5	520246	73,00	522978	46,86	10x50	520287	100,00			20x25
520227	3,80	522927	196,00	4x6	520247	78,00	522979	9,18	10x55	520288	106,00			20x30
520228	4,00	522928	210,00	4x8	520248	86,00	522980	25,50	10x60	520289	129,00			20x35
520229	4,30	522929	225,00	4x10	520249	101,52	522981	30,00	10x70	520290	156,00			20x40
520230	5,60	522930	245,00	4x12	520250	117,72	522982	10,20	10x80	520291	190,00			20x45
510500	3,80	522931	255,00	5x6	520251	138,24	522983	11,22	10x90	520292	276,00			20x50
510501	4,30	522932	275,00	5x8	520252	145,80	522984	12,24	10x100	520293	285,00			20x55
510502	4,80	522933	285,00	5x10	520253	12,50	522985	21,42	12x10	520294	292,00			20x60
510503	5,00	522934	300,00	5x12	520254	20,80	522986	32,84	12x12	520295	309,00			20x70
510504	6,48	522935	310,00	5x16	510531	29,48	522987	43,86	12x16	520296	488,00			20x80
510505	7,10	522936	320,00	5x20	510532	36,50	522988	46,92	12x20	520297	525,00			20x90
510506	10,00	522937	360,00	5x25	510533	49,00	522989	49,98	12x25	520298	581,00			20x100
510507	4,90	522938	38,51	6x8	510534	54,00	522990	59,16	12x30	520299	911,52			24x25
510508	5,20	522939	42,84	6x10	510535	62,00	522991	61,20	12x35	520300	934,20			24x30
510509	5,50	522940	29,07	6x12	510536	81,00	522992	34,00	12x40	520301	900,00			24x35
510510	7,70	522941	29,58	6x16	520255	87,00	522993	36,00	12x45	520302	1.112,40			24x40
510511	8,50	522942	30,09	6x20	520256	93,00	522994	13,26	12x50	520303	1.134,00			24x45
510512	11,77	522943	31,11	6x25	520257	115,00	522995	50,00	12x55	520304	1.188,00			24x50
510513	15,10	522944	35,70	6x30	520258	120,00	522996	14,28	12x60	520305	1.242,00			24x55
510514	18,00	522945	54,00	6x35	520259	146,88	522997	104,94	12x70	520306	1.296,00			24x60
520231	22,00	522946	42,00	6x45	520260	168,48	522998	15,30	12x80	520307	1.404,00			24x70
520232	24,00	522947	43,00	6x50	520261	178,20	522999	38,76	12x90	520308	1.512,00			24x80
520233	27,00	522948	45,00	6x55	520262	213,84	523000	42,84	12x100	520309	1.620,00			24x90
520234	30,00	522949	46,00	6x60	520263	43,42	523001	44,88	14x16	520310	1.728,00			24x100
520235	3,90	522950	48,00	8x6	520264	55,94	523002	47,94	14x20					
510523	5,62	522951	50,00	8x8	520265	66,96	523003	51,00	14x25					

DIN 916 espárrago allen chaflán afilado moleteado. 45 H

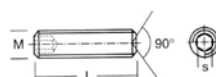

Ref. 45 H	Medida mm	€/ 100 45 H	Ref. 45 H	Medida mm	€/ 100 45 H	Ref. 45 H	Medida mm	€/ 100 45 H	Ref. 45 H	Medida mm	€/ 100 45 H
514800	3x3	3,50	514815	4x20	9,40	514830	6x30	16,31	514845	10x30	43,20
514801	3x4	5,40	514816	5x5	4,00	514831	8x8	6,07	514846	10x35	52,92
514802	3x5	5,60	514817	5x6	4,30	514832	8x10	7,90	514847	10x40	58,32
514803	3x6	6,10	514818	5x8	4,70	514833	8x12	10,20	514848	10x45	69,00
514804	3x8	6,42	514819	5x10	4,90	514834	8x16	14,20	514849	10x50	79,00
514805	3x10	7,00	514820	5x12	6,50	514835	8x20	18,00	514850	12x12	21,50
514806	3x12	8,50	514821	5x16	7,10	514836	8x25	24,84	514851	12x16	31,84
514807	3x16	9,50	514822	5x20	9,20	514837	8x30	28,00	514852	12x20	39,42
514808	4x4	3,40	514823	6x6	4,35	514838	8x35	34,56	514853	12x25	52,92
514809	4x5	3,90	514824	6x8	5,40	514839	8x40	36,72	514854	12x30	58,32
514810	4x6	4,20	514825	6x10	5,80	514840	10x10	11,66	514855	12x35	66,96
514811	4x8	5,30	514826	6x12	6,80	514841	10x12	15,51	514856	12x40	87,48
514812	4x10	5,90	514827	6x16	7,80	514842	10x16	22,00	514857	12x45	93,96
514813	4x12	6,20	514828	6x20	9,18	514843	10x20	28,58	514858	12x50	121,00
514814	4x16	6,50	514829	6x25	12,71	514844	10x25	34,99			

DIN 963 métrica

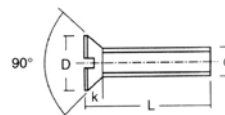

Ref. Zn	€/ 100 Zn	Ref. A2	€/ 100 A2	Longitud mm	Ref. Zn	€/ 100 Zn	Ref. A2	€/ 100 A2	Longitud mm	Ref. Zn	€/ 100 Zn	Ref. A2	€/ 100 A2	Longitud mm
510543	27,54			03x005	510571	78,58	523158	165,02	05x008	510593	161,04	523180	338,18	06x050
510544	29,90	523131	62,79	03x006	510572	87,12	523159	182,95	05x010	510594	193,62	523181	406,60	06x060
510545	32,14	523132	67,49	03x008	510573	95,40	523160	200,34	05x012	510597	209,14			08x010
510546	34,52	523133	72,49	03x010	510574	125,76	523161	264,10	05x016	510598	224,88	523185	472,25	08x012
510547	41,32	523134	86,77	03x012	510575	136,48	523162	286,61	05x020	510599	241,72	523186	507,61	08x016
510548	41,32	523135	86,77	03x016	510576	158,26	523163	332,35	05x025	510600	255,92	523187	537,43	08x020
510549	46,34	523136	97,31	03x020	510577	168,30	523164	353,43	05x030	510601	293,98	523188	617,36	08x025
510550	51,24	523137	107,60	03x025	510578	179,64	523165	377,24	05x035	510602	327,54	523189	687,83	08x030
510551	56,10			03x030	510579	49,42	523166	103,78	05x040	510603	359,72	523190	755,41	08x035
510557	28,96	523144	60,82	04x006	510580	54,76	523167	115,00	05x045	510604	140,90	523191	295,89	08x040
510558	32,14	523145	67,49	04x008	510581	60,32	523168	126,67	05x050	510605	141,28	523192	296,69	08x045
510559	35,68	523146	74,93	04x010	510582	65,62			05x060	510606	141,28	523193	296,69	08x050
510560	39,68	523147	83,33	04x012	510584	71,32	523171	149,77	06x010	510607	143,50	523194	301,35	08x060
510561	43,84	523148	92,06	04x016	510585	78,62	523172	165,10	06x012	510611	144,50			10x020
510562	48,02	523149	100,84	04x020	510586	84,58	523173	177,62	06x016	510612	154,60			10x025
510563	52,34	523150	109,91	04x025	510587	90,42	523174	189,88	06x020	510613	165,44			10x030
510564	56,10	523151	117,81	04x030	510588	98,22	523175	206,26	06x025	510614	186,34			10x035
510565	60,32	523152	126,67	04x035	510589	111,80	523176	234,78	06x030	510615	205,28			10x040
510566	70,26	523153	147,55	04x040	510590	111,80	523177	234,78	06x035	510616	238,76			10x045
510567	70,26	523154	147,55	04x045	510591	125,26	523178	263,05	06x040	510617	261,74			10x050
510568	78,58	523155	165,02	04x050	510592	147,08	523179	308,87	06x045	510618	313,82			10x060

06



DIN 84 métrica

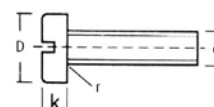

Ref. Zn	€/ 100 Zn	Ref. A2	€/ 100 A2	Longitud mm	Ref. Zn	€/ 100 Zn	Ref. A2	€/ 100 A2	Longitud mm	Ref. Zn	€/ 100 Zn	Ref. A2	€/ 100 A2	Longitud mm
510708	8,74			03x005	510733	108,63	523263	228,12	04x045	510759	216,75	523289	455,18	06x020
510709	10,78	523239	22,64	03x006	510734	110,56	523264	232,18	04x050	510760	242,36	523290	508,96	06x025
510710	12,80	523240	26,88	03x008	510738	16,89	523268	35,47	05x006	510761	300,58	523291	631,22	06x030
510711	19,04	523241	39,98	03x010	510739	20,63	523269	43,32	05x008	510762	370,80	523292	778,68	06x035
510712	27,54	523242	57,83	03x012	510740	24,56	523270	51,58	05x010	510763	400,21	523293	840,44	06x040
510714	36,66	523244	76,99	03x016	510741	54,63	523271	114,72	05x012	510764	412,58	523294	866,42	06x045
510715	54,32	523245	114,07	03x020	510743	72,65	523273	152,57	05x016	510765	440,88	523295	925,85	06x050
510716	60,88	523246	127,85	03x025	510744	108,99	523274	228,88	05x020	510766	572,47	523296	1.202,19	06x060
510717	75,62	523247	158,80	03x030	510745	121,00	523275	254,10	05x025	510770	85,98	523300	180,56	08x010
510722	12,14	523252	25,49	04x006	510746	150,23	523276	315,48	05x030	510771	120,58	523301	253,22	08x012
510723	15,90	523253	33,39	04x008	510747	185,30	523277	389,13	05x035	510773	175,69	523303	368,95	08x016
510724	25,48	523254	53,51	04x010	510748	195,34	523278	410,21	05x040	510774	430,25	523304	903,53	08x020
510725	31,00	523255	65,10	04x012	510749	206,87	523279	434,43	05x045	510775	484,00	523305	1.016,40	08x025
510727	38,26	523257	80,35	04x016	510750	220,57	523280	463,20	05x050	510776	600,21	523306	1.260,44	08x030
510728	56,32	523258	118,27	04x020	510751	236,52			05x060	510777	640,55	523307	1.345,16	08x035
510729	65,96	523259	138,52	04x025	510754	40,52	523284	85,09	06x008	510778	802,57	523308	1.685,40	08x040
510730	91,23	523260	191,58	04x030	510755	48,39	523285	101,61	06x010	510779	825,22	523309	1.732,96	08x045
510731	95,63	523261	200,82	04x035	510756	108,35	523286	227,54	06x012	510780	880,55	523310	1.849,16	08x050
510732	99,00	523262	207,90	04x040	510758	142,39	523288	299,01	06x016	510781	1.002,33	523311	2.104,89	08x060

DIN 85 métrica. Cincado

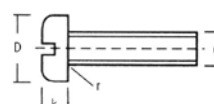

Ref. Zn	Longitud mm	€/ 100 Zn	Ref. Zn	Longitud mm	€/ 100 Zn	Ref. Zn	Longitud mm	€/ 100 Zn	Ref. Zn	Longitud mm	€/ 100 Zn
510800	03x004	18,90	510812	04x006	19,80	510824	05x008	32,33	510836	06x012	48,66
510801	03x005	15,68	510813	04x008	20,42	510825	05x010	37,42	510837	06x015	56,33
510802	03x006	16,48	510814	04x010	21,16	510826	05x012	42,30	510838	06x016	58,34
510803	03x008	17,10	510815	04x012	22,86	510827	05x015	44,56	510839	06x020	62,55
510804	03x010	17,40	510816	04x015	23,36	510828	05x020	48,96	510840	06x025	65,37
510805	03x012	18,10	510817	04x020	25,66	510829	05x025	52,33	510841	06x030	68,14
510806	03x015	18,90	510818	04x025	32,33	510830	05x030	55,88	510842	06x035	72,52
510807	03x020	19,18	510819	04x030	35,56	510831	05x035	61,33	510843	06x040	81,00
510808	03x025	19,20	510820	04x035	55,88	510832	05x040	63,33	510844	06x050	92,50
510809	03x030	21,21	510821	04x040	62,32	510833	05x050	66,88	510845	06x060	97,65
510810	03x040	17,76	510822	04x050	68,66	510834	06x008	42,55			
510811	04x005	18,36	510823	05x006	26,32	510835	06x010	45,33			

DIN 965 métrica



Ref. Zn	€/100 Zn	Ref. A2	€/100 A2	Longitud mm	Ref. Zn	€/100 Zn	Ref. A2	€/100 A2	Longitud mm	Ref. Zn	€/100 Zn	Ref. A2	€/100 A2	Longitud mm
510900	4,60			03x005	510916	65,88	523386	138,35	04x025	510930	110,43	523400	231,90	05x045
510901	5,02	523371	10,54	03x006	510917	71,24	523387	149,60	04x030	510931	125,67	523401	263,91	05x050
510902	10,30	523372	21,63	03x008	510918	75,55	523388	158,66	04x035	510932	135,98			05x060
510903	17,00	523373	35,70	03x010	510919	81,55	523389	171,26	04x040	510935	42,58	523405	89,42	06x010
510904	29,32	523374	61,57	03x012	510920	83,87	523390	176,13	04x050	510936	45,36	523406	95,26	06x012
510905	48,18	523375	101,18	03x015	510921	32,65	523391	68,57	05x008	510937	58,24	523407	122,30	06x015
510906	75,30	523376	158,13	03x020	510922	35,66	523392	74,89	05x010	510938	68,57	523408	144,00	06x020
510907	16,38	523377	34,40	03x025	510923	42,55	523393	89,36	05x012	510939	84,27	523409	176,97	06x025
510908	16,88			03x030	510924	55,22	523394	115,96	05x015	510940	95,52	523410	200,59	06x030
510911	17,42	523381	36,58	04x008	510925	65,25	523395	137,03	05x020	510941	101,25	523411	212,63	06x035
510912	23,22	523382	48,76	04x010	510926	75,24	523396	158,00	05x025	510942	110,25	523412	231,53	06x040
510913	29,52	523383	61,99	04x012	510927	85,63	523397	179,82	05x030	510943	125,20	523413	262,92	06x045
510914	50,10	523384	105,21	04x015	510928	92,51	523398	194,27	05x035	510944	145,28	523414	305,09	06x050
510915	62,35	523385	130,94	04x020	510929	101,57	523399	213,30	05x040	510945	148,32	523415	311,47	06x060

DIN 966 métrica. Cincado



Ref. Zn	Longitud mm	€/100 Zn	Ref. Zn	Longitud mm	€/100 Zn	Ref. Zn	Longitud mm	€/100 Zn	Ref. Zn	Longitud mm	€/100 Zn
511000	03x005	15,23	511009	04x008	75,32	511018	05x015	110,25	511027	06x020	102,35
511001	03x006	27,36	511010	04x010	85,27	511019	05x020	118,69	511028	06x025	135,25
511002	03x008	32,54	511011	04x012	92,27	511020	05x025	123,25	511029	06x030	158,20
511003	03x010	35,58	511012	04x015	95,27	511021	05x030	132,21	511030	06x035	152,39
511004	03x012	39,57	511013	04x020	99,77	511022	05x035	145,87	511031	06x040	158,58
511005	03x015	45,21	511014	04x025	105,36	511023	05x040	152,54	511032	06x050	165,38
511006	03x020	52,21	511015	04x030	115,27	511024	06x010	88,32			
511007	03x025	55,87	511016	05x010	89,31	511025	06x012	91,32			
511008	03x030	65,27	511017	05x012	103,20	511026	06x015	99,25			

DIN 7985 métrica



Ref. Zn	€/100 Zn	Ref. A2	€/100 A2	Longitud mm	Ref. Zn	€/100 Zn	Ref. A2	€/100 A2	Longitud mm	Ref. Zn	€/100 Zn	Ref. A2	€/100 A2	Longitud mm
511101	7,42			03x005	511120	27,98	523500	61,72	04x030	511136	38,39	523516	80,62	05x050
511102	9,62	523482	26,88	03x006	511121	29,39	523501	68,42	04x035	511137	45,36			05x060
511103	12,80	523483	30,66	03x008	511122	32,58	523502	74,04	04x040	511138	18,36	523518	38,56	06x008
511104	14,60	523484	34,13	03x010	511123	35,28			04x045	511139	22,39	523519	47,02	06x010
511105	16,25	523485	41,69	03x012	511124	36,87			04x050	511140	24,21	523520	50,84	06x012
511106	19,85	523486	44,77	03x015	511125	14,25			05x006	511141	26,35	523521	55,34	06x015
511107	21,32	523487	49,12	03x020	511126	16,20	523506	34,02	05x008	511142	27,85	523522	58,49	06x020
511108	23,39	523488	53,91	03x025	511127	18,69	523507	39,25	05x010	511143	32,35	523523	67,94	06x025
511109	25,67	523489	25,73	03x030	511128	20,30	523508	42,63	05x012	511144	35,87	523524	75,33	06x030
511113	12,25	523493	29,95	04x006	511129	23,36	523509	49,06	05x015	511145	39,38	523525	82,70	06x035
511114	14,26	523494	35,43	04x008	511130	24,65	523510	51,77	05x020	511146	42,88	523526	90,05	06x040
511115	16,87	523495	39,84	04x010	511131	27,36	523511	57,46	05x025	511147	52,32	523527	109,87	06x045
511116	18,97	523496	44,77	04x012	511132	32,68	523512	68,63	05x030	511148	55,87	523528	117,33	06x050
511117	21,32	523497	49,06	04x015	511133	34,28	523513	71,99	05x035	511149	62,32	523529	130,87	06x060
511118	23,36	523498	53,49	04x020	511134	38,39	523514	80,62	05x040					
511119	25,47	523499	58,76	04x025	511135	40,32	523515	84,67	05x045					



06

DIN 7981 cabeza alomada

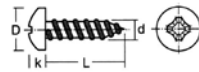

Ref. Zn	€/100 Zn	Ref. A2	€/100 A2	Longitud mm	Ref. Zn	€/100 Zn	Ref. A2	€/100 A2	Longitud mm	Ref. Zn	€/100 Zn	Ref. A2	€/100 A2	Longitud mm
523550	22,22	511200	10,58	2,9x006,5	523571	32,92	511221	15,68	3,9x022,0	523597	90,97	511247	43,32	4,8x032,0
523551	29,57	511201	14,08	2,9x009,5	523572	37,42	511222	17,82	3,9x025,0	523598	99,05	511248	47,17	4,8x038,0
523552	33,73	511202	16,06	2,9x013,0	523573	43,17	511223	20,56	3,9x032,0	523599	120,86	511249	57,55	4,8x045,0
523553	37,54	511203	17,88	2,9x016,0	523574	46,89	511224	22,33	3,9x038,0	523600	129,06	511250	61,46	4,8x050,0
523554	45,85	511204	21,84	2,9x019,0	523577	53,96	511227	25,70	4,2x009,5	523601	37,74			4,8x060,0
523555	49,25	511205	23,45	2,9x022,0	523578	56,94	511228	27,12	4,2x013,0	523602	42,70			4,8x070,0
523556	54,03	511206	25,73	2,9x025,0	523579	63,20	511229	30,10	4,2x016,0	523603	50,14			4,8x080,0
523557	59,30	511207	28,24	3,5x006,5	523580	75,49	511230	35,95	4,2x019,0	523608	20,00	511258	68,55	5,5x013,0
523558	28,30	511208	13,48	3,5x009,5	523581	79,19	511231	37,71	4,2x022,0	523609	19,94	511259	72,65	5,5x016,0
523559	32,94	511209	15,69	3,5x013,0	523582	88,68	511232	42,23	4,2x025,0	523610	22,24	511260	75,32	5,5x019,0
523560	38,97	511210	18,56	3,5x016,0	523583	93,14	511233	44,35	4,2x032,0	523611	24,28	511261	78,38	5,5x022,0
523561	43,82	511211	20,87	3,5x019,0	523584	88,68	511234	42,23	4,2x038,0	523612	26,00	511262	82,21	5,5x025,0
523562	49,25	511212	23,45	3,5x022,0	523585	104,78	511235	49,90	4,2x045,0	523613	30,64	511263	85,33	5,5x032,0
523563	53,96	511213	25,70	3,5x025,0	523586	42,41	511236	20,20	4,2x050,0	523614	34,34	511264	87,22	5,5x038,0
523564	58,84	511214	28,02	3,5x032,0	523591	51,72	511241	24,63	4,8x009,5	523615	38,30	511265	89,33	5,5x045,0
523565	64,63	511215	30,78	3,5x038,0	523592	55,93	511242	26,63	4,8x013,0	523616	41,70	511266	92,57	5,5x050,0
523567	67,89	511217	32,33	3,5x009,5	523593	60,87	511243	28,99	4,8x016,0	523617	48,04	511267	95,18	5,5x060,0
523568	75,26	511218	35,84	3,9x013,0	523594	64,33	511244	30,64	4,8x019,0	523618	54,30	511268	102,39	5,5x070,0
523569	81,50	511219	38,81	3,9x016,0	523595	74,73	511245	35,59	4,8x022,0	523619	62,68			5,5x080,0
523570	85,17	511220	40,56	3,9x019,0	523596	82,86	511246	39,46	4,8x025,0					

DIN 7982 cabeza avellanada

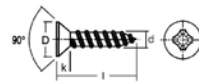
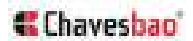

Ref. Zn	€/100 Zn	Ref. A2	€/100 A2	Longitud mm	Ref. Zn	€/100 Zn	Ref. A2	€/100 A2	Longitud mm	Ref. Zn	€/100 Zn	Ref. A2	€/100 A2	Longitud mm
511300	5,33	523650	53,35	2,9x006,5	511318	16,34	523668	23,90	3,9x019,0	511341	25,78	523691	47,09	4,8x025,0
511301	6,41	523651	68,11	2,9x009,5	511319	17,42	523669	26,28	3,9x022,0	511342	30,02	523692	51,34	4,8x032,0
511302	7,13	523652	85,68	2,9x013,0	511320	21,10	523670	29,38	3,9x025,0	511343	31,75	523693	56,02	4,8x038,0
511303	7,99	523653	24,55	2,9x016,0	511321	23,62	523671	32,98	3,9x032,0	511344	34,78	523694	60,84	4,8x045,0
511304	9,14	523654	17,21	2,9x019,0	511322	10,73	523672	36,07	3,9x038,0	511345	39,02	523695	66,31	4,8x050,0
511305	10,73	523655	17,21	2,9x022,0	511326	12,02	523676	39,67	4,2x013,0			523696	80,06	4,8x060,0
511306	7,56	523656	18,94	2,9x025,0	511327	13,25	523677	48,46	4,2x016,0			523697	90,50	4,8x070,0
511307	9,14	523657	20,30	3,5x009,5	511328	14,47	523678	56,02	4,2x019,0	511348	44,28	523698	101,38	5,5x013,0
511308	10,08	523658	22,10	3,5x013,0	511329	18,00	523679	33,12	4,2x022,0	511349	65,38	523699	114,84	5,5x016,0
511309	11,02	523659	23,76	3,5x016,0	511330	19,22	523680	31,75	4,2x025,0	511350	22,82	523700	135,86	5,5x019,0
511310	12,24	523660	23,47	3,5x019,0	511331	22,39	523681	35,42	4,2x032,0	511351	29,45	523701	153,72	5,5x022,0
511311	15,41	523661	23,04	3,5x022,0	511332	25,13	523682	39,02	4,2x038,0	511352	31,82	523702	180,50	5,5x025,0
511312	17,86	523662	25,78	3,5x025,0	511333	27,43	523683	42,41	4,2x045,0	511353	34,13	523703	72,00	5,5x032,0
511313	18,58	523663	27,86	3,5x032,0	511334	29,52	523684	46,15	4,2x050,0	511354	39,38	523704	71,78	5,5x038,0
511314	9,58	523664	30,38	3,5x038,0	511337	16,70	523687	57,82	4,8x013,0	511355	44,28	523705	80,06	5,5x045,0
511315	10,73	523665	32,98	3,9x009,5	511338	19,94	523688	64,94	4,8x016,0	511356	46,15	523706	87,41	5,5x050,0
511316	11,95	523666	41,04	3,9x013,0	511339	21,53	523689	73,37	4,8x019,0	511357	50,62	523707	93,60	5,5x060,0
511317	12,82	523667	46,01	3,9x016,0	511340	23,98	523690	82,58	4,8x022,0			523708	110,30	5,5x070,0



DIN 7983 cabeza gota sebo



Ref. Zn	€/100 Zn	Ref. A2	€/100 A2	Longitud mm	Ref. Zn	€/100 Zn	Ref. A2	€/100 A2	Longitud mm	Ref. Zn	€/100 Zn	Ref. A2	€/100 A2	Longitud mm
511400	1,48	523730	6,82	2,9x006,5	511419	4,54	523749	10,02	3,9x022,0	511442	8,34	523772	22,24	4,8x032,0
511401	1,78	523731	4,78	2,9x009,5	511420	4,84	523750	11,02	3,9x025,0	511443	8,82	523773	25,14	4,8x038,0
511402	1,98	523732	4,78	2,9x013,0	511421	5,86	523751	13,46	3,9x032,0	511444	9,66	523774	28,16	4,8x045,0
511403	2,22	523733	5,26	2,9x016,0	511422	6,56	523752	15,56	3,9x038,0	511445	10,84	523775	31,90	4,8x050,0
		523734	5,64	2,9x019,0	511425	2,98	523755	9,20	4,2x009,5	511446	12,30	523776	37,74	4,8x060,0
511405	2,54	523735	6,14	2,9x022,0	511426	3,34	523756	8,82	4,2x013,0	511447	18,16	523777	42,70	4,8x070,0
511406	2,98	523736	6,60	2,9x025,0	511427	3,68	523757	9,84	4,2x016,0	511448	6,34	523778	50,14	5,5x013,0
511407	2,10	523737	6,52	3,5x009,5	511428	4,02	523758	10,84	4,2x019,0	511449	8,18	523779	20,00	5,5x016,0
511408	2,54	523738	6,40	3,5x013,0	511429	5,00	523759	11,78	4,2x022,0	511450	8,84	523780	19,94	5,5x019,0
511409	2,80	523739	7,16	3,5x016,0	511430	5,34	523760	12,82	4,2x025,0	511451	9,48	523781	22,24	5,5x022,0
511410	3,06	523740	7,74	3,5x019,0	511431	6,22	523761	16,06	4,2x032,0	511452	10,94	523782	24,28	5,5x025,0
511411	3,40	523741	8,44	3,5x022,0	511432	6,98	523762	18,04	4,2x038,0	511453	12,30	523783	26,00	5,5x032,0
511412	4,28	523742	9,16	3,5x025,0	511433	7,62	523763	20,38	4,2x045,0	511454	12,82	523784	30,64	5,5x038,0
511413	4,96	523743	11,40	3,5x032,0	511434	8,20	523764	22,94	4,2x050,0	511455	14,06	523785	34,34	5,5x045,0
511414	5,16	523744	12,78	3,5x038,0	511437	4,64	523767	13,08	4,8x013,0	511456	14,82	523786	38,30	5,5x050,0
511415	2,66	523745	6,64	3,9x009,5	511438	5,54	523768	14,26	4,8x016,0	511457	18,92	523787	41,70	5,5x060,0
511416	2,98	523746	7,30	3,9x013,0	511439	5,98	523769	15,56	4,8x019,0	511458	23,80	523788	48,04	5,5x070,0
511417	3,32	523747	8,16	3,9x016,0	511440	6,66	523770	16,90	4,8x022,0					
511418	3,56	523748	9,16	3,9x019,0	511441	7,16	523771	18,42	4,8x025,0					

DIN 7504-N cabeza alomada punta broca



Ref.	Longitud mm	€/100	Ref.	Longitud mm	€/100	Ref.	Longitud mm	€/100	Ref.	Longitud mm	€/100
511500	3,5x009,5	2,86	511511	3,9x025,0	5,16	511520	4,2x038,0	8,06	511529	4,8x045,0	12,22
511502	3,5x013,0	3,20	511512	3,9x032,0	6,14	511521	4,2x050,0	9,64	511530	4,8x050,0	13,40
511503	3,5x016,0	3,66	511513	3,9x038,0	6,82	511522	4,8x013,0	5,44	511531	4,8x060,0	16,46
511504	3,5x019,0	4,00	511514	4,2x013,0	4,04	511523	4,8x016,0	6,02	511532	5,5x019,0	10,40
511505	3,5x022,0	4,34	511515	4,2x016,0	4,44	511524	4,8x019,0	6,52	511533	5,5x022,0	11,22
511506	3,5x025,0	4,78	511516	4,2x019,0	4,92	511525	4,8x022,0	7,02	511534	5,5x032,0	11,98
511508	3,9x013,0	3,92	511517	4,2x022,0	5,26	511526	4,8x025,0	7,44	511535	5,5x045,0	14,46
511509	3,9x016,0	4,20	511518	4,2x025,0	5,64	511527	4,8x032,0	9,64			
511510	3,9x022,0	4,88	511519	4,2x032,0	7,26	511528	4,8x038,0	10,80			

DIN 7504-P cabeza avellanada punta broca



Ref.	Longitud mm	€/100	Ref.	Longitud mm	€/100	Ref.	Longitud mm	€/100	Ref.	Longitud mm	€/100
511600	3,5x009,5	16,18	511609	3,9x019,0	24,28	511617	4,2x022,0	27,28	511625	4,8x032,0	52,58
511602	3,5x013,0	18,24	511610	3,9x022,0	26,28	511618	4,2x025,0	28,28	511626	4,8x038,0	56,62
511603	3,5x016,0	20,22	511611	3,9x025,0	28,28	511619	4,2x032,0	32,36	511627	4,8x050,0	70,78
511604	3,5x019,0	22,28	511612	3,9x032,0	30,34	511620	4,2x038,0	36,40	511628	5,5x019,0	54,00
511605	3,5x022,0	24,28	511613	3,9x038,0	34,38	511621	4,8x013,0	34,38	511629	5,5x025,0	60,10
511606	3,5x025,0	26,28	511614	4,2x013,0	20,22	511622	4,8x016,0	36,40	511630	5,5x032,0	71,88
511607	3,9x013,0	18,24	511615	4,2x016,0	22,28	511623	4,8x019,0	40,44	511631	5,5x038,0	78,14
511608	3,9x016,0	20,22	511616	4,2x019,0	25,30	511624	4,8x025,0	44,46	511632	5,5x050,0	99,60



06

Tornillo autotaladrante C/ Alomada. Zincado



Tornillo autotaladrante de cabeza alomada y huella Ph. Cincado. Huella Ph

Ref.	Código	Medida mm	€/100
8005292	3509SIBR	3,5 x 9,5	1,44
8005293	3513SIBR	3,5 x 13	1,74
8005294	3516SIBR	3,5 x 16	1,84
8005295	3519SIBR	3,5 x 19	2,02
8005296	3913SIBR	3,9 x 13	2,11
8005302	4225SIBR	4,2 x 25	3,35
8005303	4816SIBR	4,8 x 16	3,23
8005304	4819SIBR	4,8 x 19	3,52
8005305	4825SIBR	4,8 x 25	4,30
8005306	4832SIBR	4,8 x 32	5,12
8005307	4838SIBR	4,8 x 38	5,70
8005308	4845SIBR	4,8 x 45	6,77
8005309	4850SIBR	4,8 x 50	7,48
8005310	4860SIBR	4,8 x 60	9,12
8005311	4880SIBR	4,8 x 80	12,30



Tornillo autotaladrante C/ Avellanada. Zincado. Phillips



Tornillo autotaladrante con cabeza avellanada y huella Ph. Cincado. Huella Ph

Ref.	Código	Medida mm	€/100
8005312	3513SIBP	3,5 x 13	1,52
8005313	3516SIBP	3,5 x 16	1,71
8005314	3519SIBP	3,5 x 19	1,87
8005315	3525SIBP	3,9 x 25	2,30
8005316	3913SIBP	3,9 x 13	1,72
8005317	3916SIBP	3,9 x 16	1,99
8005318	3919SIBP	3,9 x 19	2,21
8005319	3925SIBP	3,9 x 25	2,64
8005320	4216SIBP	4,2 x 16	2,18
8005321	4219SIBP	4,2 x 19	2,40
8005322	4225SIBP	4,2 x 25	3,05
8005323	4232SIBP	4,2 x 32	3,42
8005324	4238SIBP	4,2 x 38	4,09
8005325	4819SIBP	4,8 x 19	3,15
8005326	4825SIBP	4,8 x 25	3,55
8005327	4832SIBP	4,8 x 32	4,71
8005328	4838SIBP	4,8 x 38	5,19
8005329	4850SIBP	4,8 x 50	6,82
8005330	5550SIBP	5,5 x 50	9,14



Cabeza hexagonal punta broca con arandela EPDM



Tornillo autotaladrante de cabeza hexagonal. Tornillo con arandela vulcanizada de acero-EPDM

Ref.	Código	Medida mm	€/100
8005351	481914SIBE	4,8 x 19 P14	3,35
8005352	482514SIBE	4,8 x 25 P14	4,46
8005353	481916SIBE	4,8 x 19 P16	3,62
8005354	482516SIBE	4,8 x 25 P16	4,15
8005356	552216SIBE	5,5 x 22 P16	4,41
8005357	552516SIBE	5,5 x 25 P16	5,32
8005358	553216SIBE	5,5 x 32 P16	5,63
8005359	553816SIBE	5,5 x 38 P16	6,44
8005360	555016SIBE	5,5 x 50 P16	7,43
8005361	632516SIBE	6,3 x 25 P16	5,99
8005362	633816SIBE	6,3 x 38 P16	7,83
8005363	481914SIBEP	4,8 x 19 P14. Bote plástico	43,59
8005364	552216SIBEP	5,5 x 22 P16. Bote plástico	55,72



DIN 7504-K cabeza hexagonal punta broca

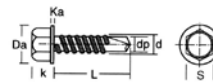

Ref.	Longitud mm	€/100	Ref.	Longitud mm	€/100	Ref.	Longitud mm	€/100	Ref.	Longitud mm	€/100
511701	3,5x013,0	4,58	511707	4,2x016,0	5,68	511713	4,8x016,0	6,68	511719	5,5x022,0	10,26
511702	3,5x016,0	4,82	511708	4,2x019,0	6,22	511714	4,8x019,0	7,26	511720	5,5x025,0	10,84
511703	3,5x019,0	5,20	511709	4,2x025,0	6,98	511715	4,8x025,0	8,12	511721	5,5x032,0	12,74
511704	3,5x025,0	5,58	511710	4,2x032,0	8,16	511716	4,8x032,0	10,26	511722	5,5x038,0	13,98
511705	3,5x032,0	5,96	511711	4,2x038,0	8,92	511717	4,8x038,0	11,68			
511706	4,2x013,0	7,30	511712	4,8x013,0	6,06	511718	5,5x019,0	9,54			

Cabeza hexagonal punta broca



Tornillo autotaladrante de cabeza hexagonal. Tornillo

Ref.	Código	Medida mm	€/100
8005331	4213SIBE	4,2 x 13	3,13
8005332	4216SIBE	4,2 x 16	3,45
8005333	4219SIBE	4,2 x 19	3,84
8005334	4816SIBE	4,8 x 16	4,26
8005335	4819SIBE	4,8 x 19	4,49
8005336	4825SIBE	4,8 x 25	5,46
8005337	5519SIBE	5,5 x 19	6,11
8005338	5522SIBE	5,5 x 22	6,23
8005339	5525SIBE	5,5 x 25	6,87
8005340	5532SIBE	5,5 x 32	8,14
8005341	5538SIBE	5,5 x 38	9,25
8005342	5550SIBE	5,5 x 50	11,02
8005343	5563SIBE	5,5 x 63	13,06
8005344	6325SIBE	6,3 x 25	10,06
8005345	6332SIBE	6,3 x 32	12,18
8005346	6338SIBE	6,3 x 38	13,18
8005347	6350SIBE	6,3 x 50	15,90
8005348	6363SIBE	6,3 x 63	19,06
8005349	6375SIBE	6,3 x 75	22,90
8005350	6380SIBE	6,3 x 80	24,83

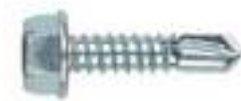

Arandela vulcanizada de acero



Arandela vulcanizada de acero-EPDM. Pregalvanizada

Ref.	Código	Medida	€/100
8005365	16SIAR	EPDM P16	2,48
8005366	18SIAR	EPDM P18	3,13
8005367	25SIAR	EPDM P25	5,72



DIN 571 . Cincado

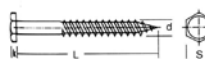

Ref. Zn	Longitud mm	€/ 100 Zn	Ref. Zn	Longitud mm	€/ 100 Zn	Ref. Zn	Longitud mm	€/ 100 Zn	Ref. Zn	Longitud mm	€/ 100 Zn
511810	06x025	7,98	511828	07x060	19,56	511843	08x080	32,58	511861	10x080	63,50
511811	06x030	8,50	511829	07x070	22,28	511844	08x090	38,46	511862	10x090	66,74
511812	06x035	9,58	511830	07x080	25,14	511845	08x100	42,20	511863	10x100	78,34
511813	06x040	9,92	511831	07x090	29,10	511846	08x110	45,36	511864	10x110	82,00
511814	06x045	10,60	511832	07x100	32,16	511847	08x120	48,70	511865	10x120	92,34
511815	06x050	11,50	511833	07x110	34,54	511848	08x130	56,40	511866	10x130	103,46
511816	06x060	13,66	511834	07x120	36,26	511849	08x140	59,82	511867	10x140	114,48
511817	06x070	15,18	511836	08x030	18,70	511850	08x150	63,34	511868	10x150	125,58
511818	06x080	18,16	511837	08x035	19,18	511851	08x160	66,92	511869	10x160	138,00
511823	07x030	14,92	511838	08x040	19,76	511852	08x180	83,86	511870	10x180	151,80
511824	07x035	15,46	511839	08x045	20,84	511853	08x200	92,12	511871	10x200	168,10
511825	07x040	15,84	511840	08x050	22,24	511858	10x050	43,16			
511826	07x045	16,56	511841	08x060	25,42	511859	10x060	49,60			
511827	07x050	17,12	511842	08x070	28,82	511860	10x070	56,52			

SPAX Cabeza plana WIROX



Ref.	Código	Longitud mm	€/100	Ref.	Código	Longitud mm	€/100	Ref.	Código	Longitud mm	€/100
523950	1081010250105	2,5x10	3,74	523976	1081010350305	3,5x30	5,99	524001	1081010450355	4,5x35	12,09
523951	1081010250125	2,5x12	3,88	523977	1081010350355	3,5x35	7,08	524002	1081010450405	4,5x40	12,62
523953	1081010250165	2,5x16	3,59	523978	1081010350405	3,5x40	8,54	524003	1081010450455	4,5x45	14,31
523954	1081010250205	2,5x20	4,39	523979	1081010350455	3,5x45	10,14	524004	1081010450505	4,5x50	16,01
523955	1081010250255	2,5x25	4,71	523980	1081010350505	3,5x50	10,31	524005	1081010450555	4,5x55	20,23
523956	1081010300105	3,0x10	4,00	523981	1081010400125	4,0x12	6,41	524006	1081010450605	4,5x60	23,90
523957	1081010300125	3,0x12	4,24	523982	1081010400155	4,0x15	6,76	524007	1081010450705	4,5x70	26,04
523958	1081010300135	3,0x13	5,16	523983	1081010400165	4,0x16	6,08	524008	1081010450805	4,5x80	30,36
523959	1081010300155	3,0x15	4,89	523984	1081010400175	4,0x17	6,23	524009	1081010500165	5,0x16	12,71
523960	1081010300165	3,0x16	3,87	523986	1081010400205	4,0x20	6,59	524010	1081010500205	5,0x20	13,14
523961	1081010300205	3,0x20	4,25	523987	1081010400255	4,0x25	7,29	524011	1081010500255	5,0x25	14,34
523962	1081010300255	3,0x25	5,23	523988	1081010400305	4,0x30	7,55	524012	1081010500305	5,0x30	15,44
523963	1081010300305	3,0x30	6,15	523989	1081010400355	4,0x35	7,99	524013	1081010500355	5,0x35	17,06
523964	1081010300355	3,0x35	8,54	523990	1081010400405	4,0x40	9,94	524014	1081010500405	5,0x40	14,99
523965	1081010300405	3,0x40	9,25	523991	1081010400455	4,0x45	11,28	524015	1081010500455	5,0x45	16,69
523966	1081010300455	3,0x45	9,95	523992	1081010400505	4,0x50	12,98	524016	1081010500505	5,0x50	16,85
523967	1081010300175	3,0x17	4,55	523993	1081010400555	4,0x55	16,89	524017	1081010500555	5,0x55	22,08
523969	1081010350125	3,5x12	5,09	523994	1081010400605	4,0x60	18,73	524018	1081010500605	5,0x60	22,40
523970	1081010350135	3,5x13	5,09	523995	1081010400705	4,0x70	24,55	524020	1081010500705	5,0x70	23,59
523971	1081010350155	3,5x15	4,89	523996	1081010400805	4,0x80	28,43	524021	1081010500805	5,0x80	28,48
523972	1081010350165	3,5x16	4,38	523997	1081010450165	4,5x16	8,35	524022	1081010500905	5,0x90	43,13
523973	1081010350175	3,5x17	4,38	523998	1081010450205	4,5x20	9,04	524023	1081010501005	5,0x100	51,10
523974	1081010350205	3,5x20	4,55	523999	1081010450255	4,5x25	9,78	524024	1081010501105	5,0x110	57,66
523975	1081010350255	3,5x25	5,33	524000	1081010450305	4,5x30	10,44	524025	1081010501205	5,0x120	61,34



SPAX Cabeza plana YELLOX



Ref.	Código	Longitud mm	€/100
524060	1081020200105	2,0x12	8,25
524061	1081020200125	2,0x12	8,25
524062	1081020200165	2,0x16	8,66
524063	1081020250105	2,5x10	3,74
524064	1081020250125	2,5x12	3,88
524066	1081020250165	2,5x16	3,59
524067	1081020250205	2,5x20	4,39
524068	1081020250255	2,5x25	4,71
524069	1081020300105	3,0x10	4,00
524070	1081020300125	3,0x12	4,24
524073	1081020300165	3,0x16	3,87
524075	1081020300205	3,0x20	4,25
524076	1081020300255	3,0x25	5,23
524077	1081020300305	3,0x30	6,15
524078	1081020300355	3,0x35	8,54
524079	1081020300405	3,0x40	9,25
524080	1081020300455	3,0x45	9,95
524082	1081020350125	3,5x12	5,09
524084	1081020350155	3,5x15	4,89
524085	1081020350165	3,5x16	4,38
524087	1081020350205	3,5x20	4,55
524088	1081020350255	3,5x25	5,33

Ref.	Código	Longitud mm	€/100
524089	1081020350305	3,5x30	5,99
524090	1081020350355	3,5x35	7,08
524091	1081020350405	3,5x40	8,54
524092	1081020350455	3,5x45	10,14
524093	1081020350505	3,5x50	10,31
524094	1081020400125	4,0x12	6,41
524095	1081020400155	4,0x15	6,76
524096	1081020400165	4,0x16	6,08
524098	1081020400205	4,0x20	6,59
524099	1081020400255	4,0x25	7,29
524100	1081020400305	4,0x30	7,55
524101	1081020400355	4,0x35	7,99
524102	1081020400405	4,0x40	9,94
524103	1081020400455	4,0x45	11,28
524104	1081020400505	4,0x50	12,98
524105	1081020400555	4,0x55	16,89
524106	1081020400605	4,0x60	18,73
524107	1081020400705	4,0x70	24,55
524108	1081020400805	4,0x80	28,43
524109	1081020450165	4,5x16	8,35
524110	1081020450205	4,5x20	9,04
524111	1081020450255	4,5x25	9,78

Ref.	Código	Longitud mm	€/100
524112	1081020450305	4,5x30	10,44
524113	1081020450355	4,5x35	12,09
524114	1081020450405	4,5x40	12,62
524115	1081020450455	4,5x45	14,31
524116	1081020450505	4,5x50	16,01
524118	1081020450605	4,5x60	23,90
524119	1081020450705	4,5x70	26,04
524120	1081020450805	4,5x80	30,36
524122	1081020500205	5,0x20	13,14
524123	1081020500255	5,0x25	14,34
524124	1081020500305	5,0x30	15,44
524125	1081020500355	5,0x35	17,06
524126	1081020500405	5,0x40	14,99
524127	1081020500455	5,0x45	16,69
524128	1081020500505	5,0x50	16,85
524130	1081020500605	5,0x60	22,40
524134	1081020500705	5,0x70	23,59
524136	1081020500805	5,0x80	28,48
524138	1081020500905	5,0x90	43,13
524139	1081020501005	5,0x100	51,10
524140	1081020501105	5,0x110	57,66
524141	1081020501205	5,0x120	61,34

SPAX-RA Cabeza plana galvanizada



Anclaje de marcos directo a la mampostería. No precisa taco, más seguro y duradero



Ref.	Código	Longitud mm	€/100
524180	1021010750405	7,5x40	31,08
524181	1021010750605	7,5x60	37,28
524182	1021010750805	7,5x80	44,75

Ref.	Código	Longitud mm	€/100
524183	1021010751005	7,5x100	53,69
524184	1021010751205	7,5x120	64,43
524186	1021010751505	7,5x150	96,65

Ref.	Código	Longitud mm	€/100
524187	1021010751805	7,5x180	154,63
524188	1021010752105	7,5x210	189,43

SPAX-RA Cabeza cilíndrica galvanizada



Anclaje de marcos directo a la mampostería. No precisa taco, más seguro y duradero.



Ref.	Código	Longitud mm	€/100
524200	1031010750605	7,5x60	37,28
524201	1031010750805	7,5x80	44,75

Ref.	Código	Longitud mm	€/100
524202	1031010751005	7,5x100	53,69
524203	1031010751205	7,5x120	70,90

Ref.	Código	Longitud mm	€/100
524204	1031010751505	7,5x150	101,90

SPAX Cabeza plana negro T10 TR



Reduce de forma eficiente la rotura del material de madera, incluso con distancias reducidas de los bordes. Mecanizado rápido y seguro con poco esfuerzo

Ref.	Código	Longitud mm	€/100
2401026	1191040300163	3x16	6,01
2401027	1191040300203	3x20	6,40
2401028	1191040300253	3x25	6,90
2401029	1191040300303	3x30	9,33



SPAX CABEZA PLANA NEGRO T20 TR



Reduce de forma eficiente la rotura del material de madera, incluso con distancias reducidas de los bordes. Mecanizado rápido y seguro con poco esfuerzo

Ref.	Código	Longitud mm	€/100
2401030	1191040350163	3,5x16	6,90
2401031	1191040350203	3,5x20	7,79
2401032	1191040350303	3,5x30	9,60
2401033	1191040350403	3,5x40	13,16
2401034	1191040400163	4x16	8,31
2401035	1191040400203	4x20	8,83
2401036	1191040400253	4x25	10,35
2401037	1191040400303	4x30	10,99
2401038	1191040400353	4x35	12,93
2401039	1191040400403	4x40	15,34
2401040	1191040400503	4x50	18,51
2401041	1191040400603	4x60	31,58
2401042	1191040450203	4,5x20	12,76
2401043	1191040450253	4,5x25	14,04
2401044	1191040450303	4,5x30	15,08
2401045	1191040450403	4,5x40	18,13
2401046	1191040500203	5x20	17,24
2401047	1191040500303	5x30	18,78
2401048	1191040500403	5x40	23,75
2401049	1191040500503	5x50	27,99



DIN 603-934 cabeza redonda cuello cuadrado



Ref.	Longitud mm	€/100	Ref.	Longitud mm	€/100	Ref.	Longitud mm	€/100	Ref.	Longitud mm	€/100
512400	05x016	7,86	512429	08x025	24,72	512457	10x050	65,06	512490	12x090	183,66
512401	05x020	8,82	512430	08x030	27,44	512458	10x055	69,56	512491	12x100	201,34
512402	05x025	10,02	512431	08x035	30,52	512459	10x060	75,56	512492	12x110	241,40
512403	05x030	11,50	512432	08x040	33,72	512460	10x065	86,00	512493	12x120	260,30
512404	05x035	13,02	512433	08x045	36,94	512461	10x070	86,00	512494	12x130	279,24
512405	05x040	14,74	512434	08x050	40,26	512462	10x080	96,36	512495	12x140	297,98
512406	05x050	17,66	512435	08x055	43,16	512463	10x090	113,14	512496	12x150	316,72
512407	05x055	20,34	512436	08x060	46,40	512464	10x100	123,88	512497	12x160	335,62
512408	05x060	21,90	512437	08x065	54,04	512465	10x110	148,94	512499	12x180	374,58
512411	06x016	12,26	512438	08x070	54,04	512466	10x120	160,88	512501	12x200	412,12
512412	06x020	12,44	512439	08x080	60,44	512467	10x130	172,98	512511	16x060	371,40
512413	06x025	13,92	512440	08x090	60,44	512468	10x140	185,94	512513	16x070	396,86
512414	06x030	15,68	512441	08x100	67,02	512469	10x150	196,86	512514	16x080	422,20
512415	06x035	17,56	512442	08x110	73,38	512470	10x160	226,14	512515	16x090	447,72
512416	06x040	19,38	512443	08x120	96,74	512472	10x180	251,96	512516	16x100	473,14
512417	06x045	21,18	512444	08x130	104,98	512474	10x200	276,70	512517	16x110	506,20
512418	06x050	23,00	512445	08x140	121,74	512479	12x030	108,38	512518	16x120	579,98
512419	06x055	24,72	512446	08x150	129,46	512480	12x035	108,68	512519	16x130	590,10
512420	06x060	26,56	512447	08x160	138,18	512481	12x040	108,68	512520	16x140	605,46
512421	06x065	31,78	512451	10x020	38,02	512482	12x045	110,38	512521	16x150	630,82
512422	06x070	31,78	512452	10x025	42,12	512483	12x050	111,16	512522	16x160	681,68
512423	06x080	35,64	512453	10x030	46,40	512484	12x055	118,92	512523	16x180	763,12
512424	06x090	39,42	512454	10x035	50,48	512485	12x060	127,26	512524	16x200	814,10
512425	06x100	43,16	512455	10x040	54,86	512487	12x070	143,34			
512428	08x020	22,28	512456	10x045	60,48	512489	12x080	157,90			

DIN 444-B

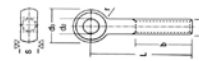

Ref.	Longitud mm	d1	d2 mm	d3 mm	Longitud mm	S mm	€/100
512600	30	M5	5	12	30	6	15,04
512601	35	M6	5	12	30	6	15,04
512602	40	M7	5	12	30	6	15,04
512603	60	M8	5	12	30	6	15,04
512604	80	M9	5	12	30	6	10,14
512605	30	M6	6	10	30	7	14,68
512606	40	M7	6	10	30	7	15,10
512607	50	M8	6	10	30	7	15,10
512608	60	M9	6	10	30	7	15,22
512609	70	M10	6	10	30	7	15,22
512610	75	M11	6	10	30	7	15,38
512611	80	M12	6	10	30	7	15,38
512612	50	M8	8	18	50	9	15,98
512613	60	M9	8	18	50	9	16,20
512614	70	M10	8	18	50	9	16,40
512615	75	M11	8	18	50	9	16,54

Ref.	Longitud mm	d1	d2 mm	d3 mm	Longitud mm	S mm	€/100
512616	80	M8	8	18	80	9	16,88
512617	90	M9	8	18	80	9	17,16
512618	100	M10	8	18	80	9	17,42
512619	120	M11	8	18	80	9	20,46
512620	50	M10	-	20	50	12	18,74
512621	60	M11	-	20	50	12	19,30
512622	70	M12	-	20	50	12	19,44
512623	75	M13	-	20	50	12	20,06
512624	80	M14	-	20	50	12	20,34
512625	90	M15	-	20	50	12	20,54
512626	100	M16	-	20	50	12	20,74
512627	120	M17	-	20	50	12	21,64
512628	60	M12	12	25	60	14	22,12
512629	70	M13	12	25	60	14	22,66
512630	75	M14	12	25	60	14	23,08
512631	80	M15	12	25	60	14	23,36

Ref.	Longitud mm	d1	d2 mm	d3 mm	Longitud mm	S mm	€/100
512632	90	M12	12	25	90	14	23,64
512633	100	M13	12	25	90	14	24,18
512634	120	M14	12	25	90	14	25,50
512635	130	M15	12	25	90	14	28,82
512636	150	M16	12	25	90	14	35,34
512637	160	M17	12	25	90	14	40,30
512638	80	M16	16	32	80	17	36,44
512639	100	M17	16	32	80	17	40,66
512640	120	M18	16	32	80	17	43,34
512641	130	M19	16	32	80	17	45,62
512642	140	M20	16	32	80	17	51,68
512643	180	M21	16	32	80	17	53,20
512644	140	M20	18	40	140	22	57,74
512645	180	M21	18	40	140	22	78,28

DIN 480 métrica

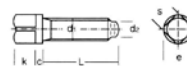

Ref.	d1	l mm	S mm	e mm	€/100
512700	M6	20	6	8	14,54
512701	M6	30	6	8	14,54
512702	M6	40	6	8	13,66
512703	M8	20	8	10	11,58
512704	M8	25	8	10	11,86
512705	M8	30	8	10	12,40
512706	M8	35	8	10	12,96
512707	M8	40	8	10	13,38
512708	M8	45	8	10	13,66
512709	M8	50	8	10	14,54
512710	M10	25	10	13	12,06
512711	M10	30	10	13	12,68
512712	M10	35	10	13	13,16
512713	M10	40	10	13	13,38
512714	M10	45	10	13	13,92

Ref.	d1	l mm	S mm	e mm	€/100
512715	M10	50	10	13	14,54
512716	M10	60	10	13	14,76
512717	M12	25	13	17	12,96
512718	M12	30	13	17	13,38
512719	M12	35	13	17	13,66
512720	M12	40	13	17	14,12
512721	M12	45	13	17	14,54
512722	M12	50	13	17	14,94
512723	M12	60	13	17	15,50
512724	M12	70	13	17	16,04
512725	M14	50	14	18	16,20
512726	M14	60	14	18	16,74
512727	M14	70	14	18	17,02
512728	M16	60	17	22	19,78
512729	M16	70	17	22	20,26



DIN 975 varilla roscada, métrica normal

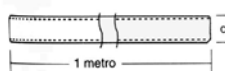

Ref. 4.8	€/ 100 4.8	Ref. 4.8 Zn	€/ 100 4.8 Zn	Ref. 8.8	€/ 100 8.8	Ref. 8.8 Zn	€/ 100 8.8 Zn	Ref. A2	€/ 100 A2	d	Paso
512900	112,60	524270	97,22					521950	431,58	M3	0,50
512901	112,60	524271	111,04					521951	470,86	M4	0,70
512902	134,66	524272	143,58					521952	482,58	M5	0,80
512903	143,58	524273	150,12	524303	197,82	524333	220,10	521953	526,56	M6	1,00
512905	242,04	524274	251,86	524304	360,72	524334	401,30	521954	960,22	M8	1,25
512906	378,02	524275	403,46	524305	581,80	524335	593,50	521955	1.471,30	M10	1,50
512907	564,76	524276	584,80	524306	814,52	524336	906,10	521956	2.168,20	M12	1,75
512908	772,94	524277	828,12	524307	1.163,60	524337	1.248,70	521957	2.942,52	M14	2,00
512909	1.010,78	524278	1.082,90	524308	1.512,70	524338	1.598,68	521958	4.026,64	M16	2,00
512910	1.265,50	524279	1.336,08	524309	1.885,02	524339	1.936,96	521959	5.017,80	M18	2,50
512911	1.579,78	524280	1.698,70	524310	2.327,18	524340	2.474,68	521960	6.194,80	M20	2,50
512912	2.055,34	524281	2.208,24	524311	2.943,90	524341	3.144,72	521961	7.444,64	M22	2,50
512913	2.412,10	524282	2.535,02	524312	3.490,84	524342	3.758,76	521962	8.827,60	M24	3,00
512914	3.100,08	524283	3.312,44	524313	4.468,20	524343	4.970,68	521963	11.894,04	M27	3,00
512915	3.821,96	524284	4.076,74	524314	5.445,66	524344	6.058,00	521964	16.066,22	M30	3,50
512916	4.968,62	524285	5.308,24	524315	6.655,82	524345	7.404,18	521965	21.260,56	M33	3,50
512917	5.945,28	524286	6.369,96	524316	7.889,20	524346	8.776,28	521966	25.900,48	M36	4,00
512918	7.219,26	524287	7.643,98	524317	9.366,98	524347	10.420,20	521967	33.245,48	M39	4,00
512919	8.705,54	524288	9.342,56	524318	11.054,18	524348	12.297,20	521968	41.195,44	M42	4,50
512920	9.979,60	524289	10.616,54	524319	12.799,62	524349	14.238,84			M45	4,50
512921	11.041,26	524290	11.890,58	524320	14.428,68	524350	16.051,06			M48	5,00
512922	14.013,84	524291	14.863,18	524321	17.163,14	524351	19.092,98			M52	5,00

DIN 934 tuerca hexagonal

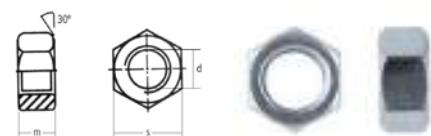

Ref. 4.8	€/ 100 4.8	Ref. 4.8 Zn	€/ 100 4.8 Zn	Ref. 8.8	€/ 100 8.8	Ref. 8.8 Zn	€/ 100 8.8 Zn	d	m mm	Paso	S mm
513000	0,72	524370	0,76					M3	2,4	0,50	5,5
513001	1,18	524371	1,26					M4	3,2	0,70	7
513002	1,34	524372	1,44					M5	4	0,80	8
513003	2,10	524373	2,24	524403	2,86	524433	3,10	M6	5	1,00	10
513006	4,44	524375	4,62	524405	6,06	524435	6,48	M8	6,5	1,25	13
513011	9,84	524376	10,34	524406	13,40	524436	14,46	M10	8	150	17
513018	14,64	524377	15,42	524407	20,04	524437	21,56	M12	10	175	19
513021	21,18	524378	22,28	524408	28,96	524438	31,20	M14	11	200	22
513023	28,20	524379	29,68	524409	38,54	524439	41,56	M16	13	200	24
513026	41,78	524380	44,04	524410	57,20	524440	61,62	M18	15	250	27
513029	54,52	524381	57,38	524411	74,60	524441	80,36	M20	16	250	30
513032	73,56	524382	77,46	524412	100,70	524442	108,42	M22	16	250	32
513035	102,42	524383	107,80	524413	140,16	524443	150,96	M24	19	300	36
513038	167,62	524384	176,44	524414	229,34	524444	247,00	M27	22	300	41
513041	226,52	524385	238,46	524415	310,00	524445	333,86	M30	24	350	46
513044	316,92	524386	333,66	524416	433,68	524446	467,08	M33	26	350	50
513048	432,50	524387	455,30	524417	591,82	524447	637,38	M36	29	400	55
513052	552,48	524388	581,56	524418	756,00	524448	814,14	M39	31	400	60
513056	717,52	524389	755,34	524419	981,86	524449	1.057,42	M42	32	450	65
513064	1.075,20	524390	1.131,78	524420	1.471,36	524450	1.584,50	M48	38	500	75
513067	1.342,62	524391	1.413,26	524421	1.837,26	524451	1.978,60	M52	40	500	80

DIN 936 contratuerca. Cincado



Ref. Zn	d	Hilos	m mm	S mm	€/100 Zn
513100	M5	0,80	3	8	2,28
513101	M6	1	4	10	2,78
513102	M8	1	5	13	5,72
513110	M12	1,75	7	19	18,28
513112	M14	2	8	22	29,68
513114	M16	2	8	24	36,54

Ref. Zn	d	Hilos	m mm	S mm	€/100 Zn
513117	M18	2,50	9	27	57,10
513120	M20	2,50	9	30	68,50
513121	M22	1,50	10	32	114,20
513125	M24	3	10	36	159,90
513128	M27	3	12	41	228,44
513131	M30	3,50	12	46	296,92

DIN 985 tuerca autoblocante

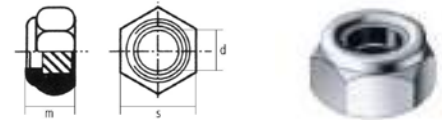

Ref. Zn	€/100 Zn	Ref. A2	€/100 A2	d	m mm	Paso	S mm
513305	7,26	524480	21,04	M8	8	1	13
513308	16,84	524481	49,14	M10	10	1	17
513311	24,00	524483	76,42	M12	12	1,25	19
513314	43,66	524485	171,96	M14	14	1,5	22
513316	49,18	524486	188,32	M16	16	1,5	24
513318	78,22	524487	818,88	M18	18	1,5	27
513321	100,46	524488	955,34	M20	20	1,5	30
513324	167,52	524490	1.637,68	M22	22	1,5	32

Ref. Zn	€/100 Zn	Ref. A2	€/100 A2	d	m mm	Paso	S mm
513327	223,34	524491	2.047,14	M24	24	1,5	36
513332	725,90			M30	30	2	46
513334	2.233,54			M33	33	2	50
513336	2.791,98			M36	36	3	55
513338	3.350,30			M39	39	3	60
513340	3.908,68			M42	42	3	65
513342	5.025,44			M45	45	3	70

DIN 935 tuerca almenada

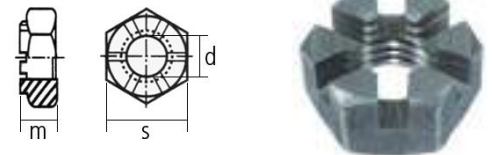

Ref.	d	Hilos	m mm	S mm	€/100
513201	M8	1,25	9,5	13	131,68
513204	M10	1,30	12	17	85,28
513207	M12	1,75	15	19	120,84
513209	M14	2	16	22	148,38
513211	M16	2	19	24	319,00
513213	M18	2,5	21	27	435,92
513215	M20	2,5	22	30	502,90

Ref.	d	Hilos	m mm	S mm	€/100
513220	M24	3	27	36	885,44
513223	M27	3	30	41	1.329,92
513226	M30	3,5	33	46	2.057,60
513229	M33	3,5	35	50	2.345,86
513233	M36	4	38	55	3.668,38
513239	M42	2	44	65	3.895,50
513241	M42	4,5	44	65	4.080,16

06



DIN 6915 tuerca para estructuras

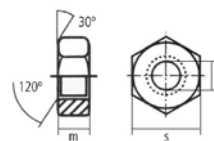

Ref.	d	m mm	Paso	S mm	€/100
513500	M12	10	1,75	22	51,36
513501	M16	13	2	27	98,78
513502	M20	16	2,50	32	162,94
513503	M22	18	2,50	36	235,06

Ref.	d	m mm	Paso	S mm	€/100
513504	M24	19	3	41	360,16
513505	M27	22	3	46	520,50
513506	M30	24	3,5	50	710,64
513507	M36	29	4	60	1.219,96

DIN 6923 tuerca de base grafilada

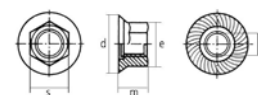

Ref. Zn	€/100 Zn	Ref. A2	€/100 A2	d	d mm	m mm	Paso	S mm
513600	2,86	524510	11,78	M4	9,2	3,5	0,70	6
513601	3,54	524511	12,98	M5	14,2	4,3	0,80	8
513602	3,86	524512	21,10	M6	14,2	6	1	10
513603	7,92	524513	43,80	M8	16,9	8	1,25	13

Ref. Zn	€/100 Zn	Ref. A2	€/100 A2	d	d mm	m mm	Paso	S mm
513604	13,08	524514	73,00	M10	21,8	10	1,50	15
513605	22,56	524515	141,92	M12	26	12	1,75	18
513606	37,06			M14	29,9	14	2	21
513607	57,92			M16	34,5	16	2	24

DIN 315 tuerca mariposa



Ref. Zn	€/100 Zn	Ref. A2	€/100 A2	d	Longitud mm	m mm	Paso	a mm
513700	12,60	524520	69,36	M3	11,5	4	0,50	9,5
513701	12,98	524521	70,78	M4	11,5	4	0,70	9,5
513702	13,40	524522	80,90	M5	11,5	4	0,80	9,5
513703	17,86	524523	121,34	M6	13,2	4,3	1	11,9
513704	22,70	524524	151,68	M8	16	5,4	1,25	13,5

Ref. Zn	€/100 Zn	Ref. A2	€/100 A2	d	Longitud mm	m mm	Paso	a mm
513705	38,54	524525	242,70	M10	18,2	6,3	1,50	15,3
513706	101,36	524526	505,62	M12	23,8	7,9	1,75	20,5
513708	303,38	524528	1.213,44	M16	32,5	10,6	2	25
513710	364,00			M20	32,9	12,2	2,50	29,3

DIN 1587 tuerca ciega

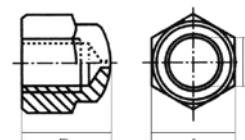

Ref. Zn	€/100 Zn	Ref. A2	€/100 A2	d	m mm	Paso	S mm
524540	20,22	513800	8,56	M4	8	0,70	7
524541	21,32	513801	9,20	M5	10	0,80	8
524542	28,92	513802	11,10	M6	12	1	10
524543	54,10	513803	23,20	M8	15	1,25	13
524544	109,38	513804	43,36	M10	18	1,50	17

Ref. Zn	€/100 Zn	Ref. A2	€/100 A2	d	m mm	Paso	S mm
524545	166,30	513805	67,54	M12	22	1,75	19
524546	886,50	513806	92,52	M14	25	2	22
524547	462,12	513807	148,38	M16	28	2	24
		513808	463,56	M18	32	2,50	27
524549	1.386,32	513809	556,66	M20	34	2,50	30

DIN 928 tuerca soldable cuadrada. Cincado

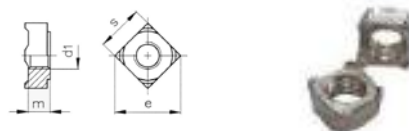

Ref.	d1	E mm	M	S	€/100
513901	M6	13	5	10	6,30
513902	M8	18	6,5	14	16,36

Ref.	d1	E mm	M	S	€/100
513903	M10	22	8	17	28,54
513904	M12	25	9,5	19	41,12

DIN 929 tuerca soldable hexagonal. Cincado

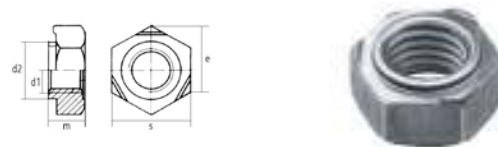

Ref.	d1	d2 mm	E mm	M	S	€/100
514001	M5	7	10,95	4	10	6,30
514002	M6	8	12,02	5	11	7,16
514003	M8	10,5	15,38	6,5	14	13,46

Ref.	d1	d2 mm	E mm	M	S	€/100
514004	M10	12,5	18,74	8	17	24,34
514005	M12	14,8	20,91	10	19	34,84

Tuerca rápida de seguridad Denominación "U" para tornillo rosca DIN 7970



Acero para muelles. HRc 43/49 [HV 420-500]. Aceitado Antioxidante.

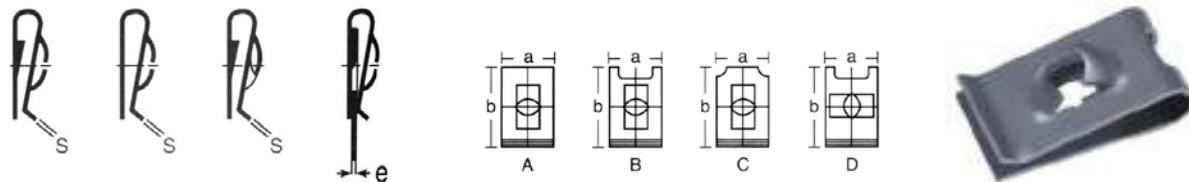

Ref.	b	c	d	E mm	Fig.	Ø Din 7970	S	x mín.	y mín.	a	€/100
501900	16±0,3	8,5-0,3	6 +0,2	0,6-1,2	3	2,9 [ISO-4]	0,4	9,5	8,5	9 ±0,2	28,75
501901	11±0,3	4,5-0,3	5 +0,2	0,7-1,2	1	2,9 [ISO-4]	0,5	8,5	6	8 ±0,2	21,85
501902	12±0,3	5-0,3	4,7 +0,2	2,0-3,0	1	2,9 [ISO-4]	0,5	8,5	8	8 ±0,2	33,35
501903	12±0,3	6,5-0,3	5 +0,2	0,7-1,0	1	3,5 [ISO-6]	0,6	9,5	7	9 ±0,2	25,30
501904	12±0,3	6-0,3	5 +0,2	1,1-1,5	1	3,5 [ISO-6]	0,6	9,5	7	9 ±0,2	24,15
501905	12±0,3	6-0,3	5 +0,2	1,6-2,0	1	3,5 [ISO-6]	0,6	9,5	7	9 ±0,2	25,30
501906	11,5±0,3	5-0,3	5 +0,2	2,1-2,5	1	3,5 [ISO-6]	0,6	9,5	7,5	9 ±0,2	26,45
501907	12±0,3	6,5-0,3	6 +0,2	0,7-1,0	1	3,9 [ISO-7]	0,6	9,5	7	9 ±0,2	27,60
501908	12±0,3	6-0,3	6 +0,2	1,1-1,5	1	3,9 [ISO-7]	0,6	9,5	7	9 ±0,2	28,75
501909	11,7±0,3	5-0,3	6,5 +0,2	0,6-0,8	1	4,2 [ISO-8]	0,6	16,5	7	16 ±0,2	29,90
501910	10,5±0,3	5,3-0,3	6 +0,2	0,6-1,1	1	4,2 [ISO-8]	0,6	9,5	6	9 ±0,2	23,00
501911	12±0,3	6,5-0,3	6 +0,2	0,7-1,0	1	4,2 [ISO-8]	0,6	9,5	7	9 ±0,2	26,45
501912	17,6±0,3	8-0,3	7 +0,2	0,7-1,6	1	4,2 [ISO-8]	0,6	11,5	8,5	11 ±0,2	25,30
501913	19±0,3	12-0,3	7 +0,2	0,8-1,5	1	4,2 [ISO-8]	0,6	9,5	12	9 ±0,2	40,25
501914	12±0,3	6-0,3	6 +0,2	1,1-1,5	1	4,2 [ISO-8]	0,6	9,5	7	9 ±0,2	25,30
501915	10,5±0,3	4,5-0,3	6 +0,2	1,4-1,6	1	4,2 [ISO-8]	0,6	9,5	6	9 ±0,2	23,00
501916	12±0,3	6-0,3	6 +0,2	1,6-2,0	1	4,2 [ISO-8]	0,6	9,5	7	9 ±0,2	25,30
501917	15,5±0,3	6-0,3	6 +0,2	1,7-2,2	1	4,2 [ISO-8]	0,6	16,5	8,5	16 ±0,2	36,80
501918	11,5±0,3	5-0,3	6 +0,2	2,1-2,5	1	4,2 [ISO-8]	0,6	9,5	7,5	9 ±0,2	25,30
501919	16±0,3	6,5-0,3	6 +0,2	3,5-4,8	2	4,2 [ISO-8]	0,6	11,5	8,5	11 ±0,2	26,45
501920	21±0,3	9,5-0,3	7 +0,2	0,6-1,0	1	4,8 [ISO-10]	0,7	12,5	12	12 ±0,2	40,25
501922	21±0,3	9-0,3	7 +0,2	1,1-2,5	1	4,8 [ISO-10]	0,7	12,5	12	12 ±0,2	41,40
501923	15±0,3	6-0,3	7 +0,2	1,5-2,4	1	4,8 [ISO-10]	0,7	12,5	10	12 ±0,2	28,75
501924	21±0,3	9-0,3	6 +0,2	1,5-3,0	2	4,8 [ISO-10]	0,7	12,5	12	12 ±0,2	43,70
501925	15±0,3	5,5-0,3	7 +0,2	2,5-3,2	1	4,8 [ISO-10]	0,7	12,5	10	12 ±0,2	28,75
501926	21±0,3	8-0,3	7 +0,2	2,6-3,8	1	4,8 [ISO-10]	0,7	12,5	12	12 ±0,2	44,85
501927	16,5±0,3	9-0,3	7 +0,2	0,4-0,9	1	5,5 [ISO-12]	0,8	16,5	9	16 ±0,2	28,75
501928	14,7±0,3	6,5-0,3	6,5 +0,2	0,8-1,5	2	5,5 [ISO-12]	0,8	16,5	9	16 ±0,2	25,30
501929	16±0,3	8-0,3	7 +0,2	1,6-2,1	1	5,5 [ISO-12]	0,8	16,5	9	16 ±0,2	41,40

06



Tuerca rápida de seguridad Denominación "U" para tornillo rosca métrica

MIKALOR

Acero para muelles. HRc 43/49 [HV 420-500]. Aceitado Antioxidante.

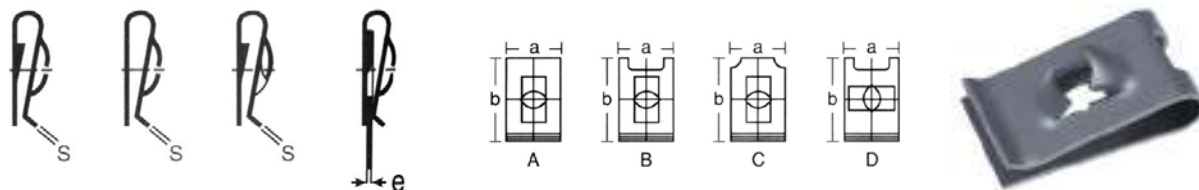

Ref.	b	c	d	E mm	Fig.	Ø Medida Nominal	S	x mín.	y mín.	a	€/100
502000	12 ±0,3	6 -0,3	5 +0,2	0,8-1,6	1	M-3	0,3	8,5	6,5	8 ±0,2	11,50
502001	16 ±0,3	7 -0,3	5 +0,2	0,6-2,5	2	M-4	0,4	10,5	8,5	10 ±0,2	13,80
502002	18 ±0,3	8,5 -0,3	6 +0,2	1,0-2,0	1	M-4	0,4	10,5	8,5	10 ±0,2	17,25
502003	17,5 ±0,3	7 -0,3	6 +0,2	3,0-4,0	1	M-4	0,4	10,5	8,5	10 ±0,2	34,50
502004	15 ±0,3	6,5 -0,3	7 +0,2	0,6-1,1	1	M-5	0,5	12,5	8	12 ±0,2	28,75
502005	21 ±0,3	9,5 -0,3	7 +0,2	0,6-1,4	1	M-5	0,5	12,5	10	12 ±0,2	34,50
502006	24 ±0,3	12,5 -0,3	7 +0,2	0,6-1,4	1	M-5	0,5	12,5	10,7	12 ±0,2	40,25
502007	15 ±0,3	6,5 -0,3	7 +0,2	1,2-1,8	1	M-5	0,5	12,5	8	12 ±0,2	28,75
502008	21 ±0,3	9 -0,3	7 +0,2	1,5-2,6	1	M-5	0,5	12,5	10	12 ±0,2	34,50
502009	24 ±0,3	12 -0,3	7 +0,2	1,5-2,6	1	M-5	0,5	12,5	10,7	12 ±0,2	41,40
502010	15 ±0,3	6 -0,3	7 +0,2	1,9-2,2	1	M-5	0,5	12,5	8	12 ±0,2	28,75
502011	14,7 ±0,3	5,5 -0,3	7 +0,2	2,3-3,0	1	M-5	0,5	12,5	8	12 ±0,2	29,90
502012	16,5 ±0,3	8,4 -0,3	8 +0,2	1,0-1,8	1	M-6	0,5	16,5	8	16 ±0,2	20,70
502013	16,2 ±0,3	7,4 -0,3	8 +0,2	1,9-3,0	1	M-6	0,5	16,5	8	16 ±0,2	21,85
502014	24,5 ±0,3	10 -0,3	8 +0,2	2,0-3,2	1	M-6	0,5	14,5	10,7	16 ±0,2	41,40
502015	24,5 ±0,3	9 -0,3	8 +0,2	3,3-4,6	1	M-6	0,5	14,5	10,7	16 ±0,2	44,85
502016	16,4 ±0,3	7,5 -0,3	8,5 +0,2	0,6-1,1	1	1/4"	0,9	18,5	8	18 ±0,2	46,00
502017	30 ±0,3	16,5 -0,3	9 +0,2	0,7-1,4	1	1/4"	0,8	14,5	10	14 ±0,2	57,50
502018	16,3 ±0,3	7 -0,3	8,5 +0,2	1,2-1,8	1	1/4"	0,9	18,5	8	18 ±0,2	28,75
502019	30,5 ±0,3	16,5 -0,3	9 +0,2	1,5-2,3	1	1/4"	1	14,5	12	14 ±0,2	67,85

Tuerca de expansión

MIKALOR

Acero para muelles.
HV 40/47 [HV 390-470].
Aceitado Antioxidante.



Ref.	Fig.	a	b	c	d	f	Longitud mm	K	±0,1 H	±0,1 J	e	Ø Din 7970	€/100	
502200	A	14,5	7	10	13,5	0,7	9	2,5	0,75	12,6-13,1	8,8	0,8-1,2-1,2-1,6	4,8 (ISO-10)	22,80
502201	B	11,1	7,5	5,16	8,8	0,5	5,69	1	-	8,3	8,8	0,6-1,0	3,5 (ISO-6)	23,40
502202	B	13,5	9,5	6,3	10,8	0,6	7,1	1	-	10,2	-	0,6-1,0	4,2 (ISO-8)	24,00

Tuerca rápida universal

MIKALOR

Acero para muelles. HV 40/45 [HV 390-445]. Aceitado Antioxidante.

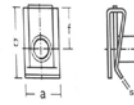

Ref.	b	c	d	E mm	f	S	x mín.	y mín.	a	€/100
502300	14,8	7	6,2	0,5-4	8	0,6	-	-	12	48,30
502306	14,8	7	6,2	0,5-4	8	0,6	-	-	16	96,60
502301	19,6	9,4	6,2	0,5-4	10,6	0,6	-	-	12	63,25
502307	21,6	10	7,7	0,5-4	12,2	0,6	16	10	16	78,20
502302	22	11	9,2	0,5-4	12,2	0,75	17	15	14	59,80
502308	22	11	9,2	0,5-4	12,2	0,75	17	15	16,6	72,45
502303	23,8	11,5	9	0,7-4	12,75	0,85	-	-	14,5	81,65
502309	23,8	11,5	9	0,7-4	12,75	0,85	-	-	16,6	96,60
502304	24,3	13	11,2	0,5-4	14,5	1	18	16	15	92,00
502305	24,3	13	11,2	0,5-4	14,5	1	18	16	15	93,15

Tuerca enjaulada Denominación Clip

MIKALOR

Jaula de acero para muelles. HRc 40/47 [HV 390-470]. Aceitado antioxidante.

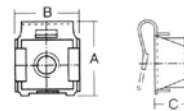

Ref.	Medida nom. d	A+0,5	B+0,3	C+0,3	E mm	s	x mín.	y mín.	€/100
502400	M 4 [0,5-1,1]	15,8	11,7	6,4	7	0,6	12,5	10	48,30
502401	M 4 [1,2-1,8]	15,6	11,7	6,4	7	0,6	12,5	10	49,45
502402	M 4 [1,9-2,5]	15,5	11,7	6,4	7	0,6	12,5	10	50,60
502403	M 5 [0,5-1,1]	15,8	11,7	6,4	7	0,6	12,5	10	50,60
502404	M 5 [1,2-1,8]	15,6	11,7	6,4	7	0,6	12,5	10	51,75
502405	M 5 [1,9-2,5]	15,5	11,7	6,4	7	0,6	12,5	10	52,90
502406	M 6 [0,5-1,1]	15,8	11,7	6,4	7	0,6	12,5	10	54,05
502407	M 6 [1,2-1,8]	15,6	11,7	6,4	7	0,6	12,5	10	55,20
502408	M 6 [1,9-2,5]	15,5	11,7	6,4	7	0,6	12,5	10	56,35
502409	M 6 [0,5-1,0]	23,3	14,9	7,8	7	0,8	16,1	14	80,50
502410	M 6 [1,1-2,0]	23,3	14,9	7,8	7	0,8	16,1	14	83,95
502412	M 6 [2,1-3,0]	23,3	14,9	7,8	7	0,8	16,1	14	86,25
502420	M 7 [0,7-1,0]	23,5	15,3	8,3	8	1	16,1	14	82,80
502413	M 7 [1,1-2,0]	23,5	15,3	8,3	8	1	16,1	14	86,25
502414	M 7 [2,1-3,0]	23,5	15,3	8,3	8	1	16,1	14	97,75
502415	M 8 [0,7-1,0]	23,5	15,3	8,3	9	1	16,1	14	86,25
502416	M 8 [1,1-2,0]	23,5	15,3	8,3	9	1	16,1	14	90,85
502417	M 8 [2,1-3,0]	23,5	15,3	8,3	9	1	16,1	14	100,05

Tuerca enjaulada cilíndrica

MIKALOR

Jaula, tuerca: Acero cincado.

Ref.	Medida nom. d	D-0,5	B±0,4	d1±0,1	s	€/100
502500	M 4 [0,7-4,0]	12,3	13	9,9	0,6	66,70
502501	M 5 [0,7-4,0]	12,3	13	9,9	0,6	69,00
502502	M 6 [0,7-4,0]	12,3	13	9,9	0,6	71,30
502503	M8 [1,0-6,0]	15,3	18,2	12,9	0,9	126,50

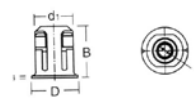

Tuerca enjaulada para nivelación

MIKALOR

Jaula de acero para muelles. HRc 40/47 [HV 390-470]. Aceitado antioxidante.

Ref.	Medida Nom. d	€/100
502600	M 8 [0,8-1,6]	78,03
502601	M 8 [1,7-2,4]	78,03
502602	M 10 [0,8-1,6]	97,02
502603	M 10 [1,7-2,4]	103,50



Tuerca enjaulada normal (jaula inoxidable)

MIKALOR

Jaula de acero inox. 18/8. Tuerca de acero cincado.



Ref.	Medida Nom. d	D±0,2	A+0,6	F±0,3	G±0,3	r máx	€/100
502700	M 3 [0,3-0,9]	9,3	4,8	9,7	3,6	0,25	12,83
502701	M 3 [1,0-1,6]	9,3	4,8	9,7	3,6	0,25	13,78
502702	M 3 [1,7-2,3]	9,3	4,8	9,7	3,6	0,25	14,31
502703	M 4 [0,3-0,9]	9,3	4,8	9,7	3,6	0,25	14,53
502704	M 4 [1,0-1,6]	9,3	4,8	9,7	3,6	0,25	14,84
502705	M 4 [1,7-2,3]	9,3	4,8	9,7	3,6	0,25	15,90
502706	M 4 [0,5-1,5]	12	7,2	12,2	6	1	16,96
502707	M 4 [1,6-2,5]	12	7,2	12,2	6	1	19,08
502708	M 4 [2,6-3,5]	12	7,2	12,2	6	1	20,14
502724	M4 [0,7-1,6]	13,2	8,2	13,5	6	1	29,68
502726	M4 [2,7-3,5]	13,2	8,2	13,5	6	1	30,74
502709	M 5 [0,5-1,5]	12	7,2	12,2	6	1	17,49
502710	M 5 [1,6-2,5]	12	7,2	12,2	6	1	19,61
502711	M 5 [2,6-3,5]	12	7,2	12,2	6	1	20,67

Ref.	Medida Nom. d	D±0,2	A+0,6	F±0,3	G±0,3	r máx	€/100
502727	M5 [0,7-1,6]	13,2	8,2	13,5	6	1	30,21
502728	M5 [1,7-2,7]	13,2	8,2	13,5	6	1	30,74
502729	M5 [2,7-3,5]	13,2	8,2	13,5	6	1	31,27
502712	M 6 [0,5-1,5]	12	7,2	12,2	6	1	18,02
502713	M 6 [1,6-2,5]	12	7,2	12,2	6	1	20,14
502714	M 6 [2,6-3,5]	12	7,2	12,2	6	1	21,20
502730	M6 [0,7-1,6]	13,2	8,2	13,5	6	1	31,27
502731	M6 [1,7-2,7]	13,2	8,2	13,5	6	1	31,80
502718	M 8 [1,0-1,7]	16	10,6	16,6	7,8	1	45,58
502719	M 8 [1,8-3,2]	16	10,6	16,6	7,8	1	48,76
502720	M 8 [3,3-4,7]	16	10,6	16,6	7,8	1	50,88
502721	M10 [1,0-1,7]	16	10,6	16,6	7,8	1	46,64
502722	M10 [1,8-3,2]	16	10,6	16,6	7,8	1	49,82
502723	M10 [3,3-4,7]	16	10,6	16,6	7,8	1	51,94

Tuerca enjaulada de montaje frontal

MIKALOR

Jaula de acero para muelles HRc 40/47 [HV 390-470]. Aceitado antioxidante.



Ref.	Medida Nom. d	A+0,3	B±0,5	C±0,3	D±0,3	E±0,3	S	G±0,3	€/100
502800	M 4 [0,5-1,0]	7,6	19,5	13	5,9	11,2	0,5	12	43,70
502801	M 4 [1,0-1,5]	8,1	18,5	13	5,9	11,2	0,5	12	44,85
502802	M 4 [1,5-2,0]	8,6	17,5	13	5,9	11,2	0,5	12	46,00
502803	M 5 [0,5-1,0]	7,6	19,5	13	5,9	11,2	0,5	12	47,15
502804	M 5 [1,0-1,5]	8,1	18,5	13	5,9	11,2	0,5	12	48,30
502805	M 5 [1,5-2,0]	8,6	17,5	13	5,9	11,2	0,5	12	49,45
502806	M 6 [0,5-1,0]	7,6	19,5	13	5,9	11,2	0,5	12	51,75
502807	M 6 [1,0-1,5]	8,1	18,5	13	5,9	11,2	0,5	12	52,90

Ref.	Medida Nom. d	A+0,3	B±0,5	C±0,3	D±0,3	E±0,3	S	G±0,3	€/100
502808	M 6 [1,5-2,0]	8,6	17,5	13	5,9	11,2	0,5	12	54,05
502809	[*] M 7 [0,6-1,1]	9,4	27,4	19	7,4	15,5	0,7	16,5	54,30
502810	[*] M 7 [1,1-1,6]	9,4	26,4	19	7,4	15,5	0,7	16,5	54,30
502811	[*] M 7 [1,6-2,1]	10,4	25,4	19	7,4	15,5	0,7	16,5	54,30
502812	M 8 [0,6-1,1]	9,4	27,4	19	7,4	15,5	0,7	16,5	78,20
502813	M 8 [1,1-1,6]	9,9	26,4	19	7,4	15,5	0,7	16,5	79,35
502814	M 8 [1,6-2,1]	10,4	25,4	19	7,4	15,5	0,7	16,5	80,50

Tuerca rápida

MIKALOR

Acero para muelles. HRc 43/49 [HV 425-495]. Aceitado antioxidante.



Ref.	b mm	Din 7970	M	S mm	a mm	€/100
503000	9	-	M 4	0,3	6 ±0,2	11,50
503001	14	-	M 5	0,4	8 ±0,2	14,95
503002	16	-	M 6	0,6	10 ±0,2	17,25
503003	18	-	M 8	0,5	12 ±0,3	28,75
503004	24	-	M 3	0,6	16 ±0,3	13,80
503005	14	2,9 (ISO-4)	-	0,5	8 ±0,2	13,80

Ref.	b mm	Din 7970	M	S mm	a mm	€/100
503006	13	3,5 (ISO-6)	-	0,6	8 ±0,2	16,10
503007	14	3,9 (ISO-7)	-	0,6	10 ±0,2	17,25
503008	16	4,2 (ISO-8)	-	0,6	10 ±0,2	18,40
503009	16	4,8 (ISO-10)	-	0,7	12 ±0,3	20,70
503010	19	6,3 (ISO-14)	-	1	14 ±0,3	23,00

DIN 125 arandela plana

Chavesbao

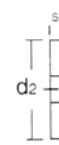

Ref. Zn	€/100 Zn	Ref. A2	€/100 A2	Para tornillos	d1 mm	d2 mm	S mm
514300	0,86	524660	1,44	M3	3,2	7	0,5
514301	0,96	524661	1,64	M4	4,3	9	0,8
514302	1,30	524662	2,24	M5	5,3	10	1
514303	2,06	524663	4,78	M6	6,4	12	1,6
514305	2,96	524665	5,76	M8	8,4	16	1,6
514306	6,14	524666	12,12	M10	10,5	20	2
514307	10,64	524667	21,42	M12	13	24	2,5
514308	16,18	524668	37,24	M14	15	28	2,5
514309	18,80	524669	41,64	M16	17	30	3
514310	25,48	524670	56,96	M18	19	34	3

Ref. Zn	€/100 Zn	Ref. A2	€/100 A2	Para tornillos	d1 mm	d2 mm	S mm
514311	28,48	524671	62,44	M20	21	37	3
514312	32,02	524672	120,50	M22	23	39	3
514313	55,18	524673	153,40	M24	25	44	4
514314	89,72	524674	230,06	M27	28	50	4
514315	113,68	524675	284,86	M30	31	56	4
514317	210,36	524676	438,22	M33	34	60	5
514319	262,92	524677	657,34	M36	37	66	5
514321	333,28	524678	876,46	M39	42	72	6
514324	740,60			M45	48	85	8
514326	1.068,20			M50	52	92	8

DIN 9021 arandela plana

Chavesbao

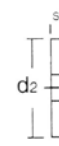

Ref. Zn	€/100 Zn	Ref. A2	€/100 A2	Para tornillos	d1 mm	d2 mm	S mm
524700	3,20	514400	1,30	M3	3,2	9	0,8
524701	3,34	514401	2,28	M4	4,3	12	1
524702	4,96	514402	3,16	M5	5,3	15	1,2
524703	8,78	514403	4,20	M6	6,4	18	1,6
524705	21,10	514405	10,40	M8	8,4	24	2
524706	41,50	514406	19,04	M10	10,5	30	2,5

Ref. Zn	€/100 Zn	Ref. A2	€/100 A2	Para tornillos	d1 mm	d2 mm	S mm
524707	75,94	514407	35,92	M12	13	37	3
524708	115,06	514408	56,14	M14	15	44	3
524709	140,24	514409	66,50	M16	17	50	3
524710	233,50	514410	125,84	M18	19	56	4
524711	255,82	514411	143,58	M20	21	60	4

DIN 6798 forma V arandela en abanico



Acero para muelles. HRc 37/43 [HV 365-425]. Aceitado antioxidante.

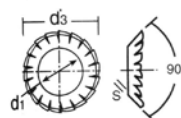

Ref.	d1 mm	d2 mm	Para Ø	Rosca W	S mm	€/100
503200	3,2	6-0,3	M - 3	1/8"	0,4±0,1	1,98
503201	4,3	8-0,36	M - 4	5/32"	0,5±0,1	2,09
503202	5,1	9-0,36	M - 5	3/16"	0,5±0,1	2,09
503203	6,4	11-0,43	M - 6	1/4"	0,7±0,1	2,64
503204	8,2	14-0,43	M - 8	5/16"	0,8±0,1	3,52

Ref.	d1 mm	d2 mm	Para Ø	Rosca W	S mm	€/100
503205	10,5	18-0,43	M - 10	3/8"	0,9±0,1	5,50
503206	12,5	20,5-0,52	M - 12	1/2"	1±0,1	11,22
503207	14,5	24-0,52	M - 14	9/16"	1±0,1	18,04
503208	16,5	26-0,52	M - 16	5/8"	1,2±0,2	27,94

Arandela dentada doble elástica



Acero para muelles. HRc 37/43 [HV 365-425]. Aceitado antioxidante.

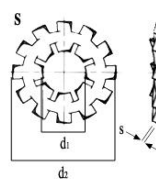

Ref.	d1 mm	d2 mm	s	€/100
503400	4,5 ± 0,3	14,00 ± 0,3	0,5	11,64
503401	5,5 ± 0,3	17,00 ± 0,3	0,5	13,56
503402	6,5 ± 0,3	20,50 ± 0,3	0,6	17,28

Ref.	d1 mm	d2 mm	s	€/100
503403	8,5 ± 0,3	23,00 ± 0,3	0,8	24,00
503404	10,5 ± 0,3	26,00 ± 0,3	1	32,64
503405	13 ± 0,3	31,00 ± 0,3	1,1	40,08

DIN 912 AET arandela dentada

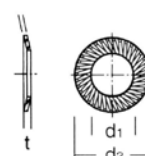

Ref.	d1 mm	d2 mm	Para tornillos	S mm	t mm	€/100
514700	3,2	5,5	M - 3	0,4	0,6	3,05
514701	4,3	7	M - 4	0,5	0,7	3,45
514702	5,3	8,5	M - 5	0,6	0,9	4,14
514703	6,4	10	M - 6	0,7	1	4,60
514704	8,4	13	M - 8	0,8	1,2	7,13

Ref.	d1 mm	d2 mm	Para tornillos	S mm	t mm	€/100
514705	10,5	16	M - 10	1	1,5	9,66
514706	13	18	M - 12	1	1,5	11,85
514707	15	21	M - 14	1,2	1,8	16,22
514708	17	24	M - 16	1,2	1,8	18,98

DIN 912 AET arandela para tornillo cincada

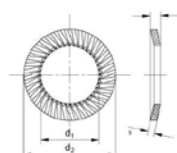

Ref.	d1 mm	d2 mm	h max mm.	Ø rosca	S mm	€/100
520400	3,2	5,5	0,85	M - 3	0,45	4,49
520401	4,3	7	0,95	M - 4	0,5	5,18
520402	5,3	9	1,05	M - 5	0,6	5,98
520403	6,4	10	1,2	M - 6	0,7	6,90
520404	8,4	13	1,4	M - 8	0,8	10,24

Ref.	d1 mm	d2 mm	h max mm.	Ø rosca	S mm	€/100
520405	10,5	16	1,6	M - 10	1	14,03
520406	13	18	1,7	M - 12	1	17,25
520407	15	21	2	M - 14	1,2	24,96
520408	17	24	2,1	M - 16	1,2	29,10

DIN 6798 forma A arandela en abanico



Acero para muelles. HRc 37/43 [HV 365-425]. Aceitado antioxidante.

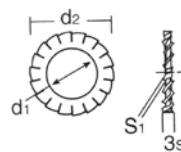

Ref.	Para Ø	d1 mm	d2 mm	S1±0,1 mm	Rosca W	€/100
503100	M - 3	3,2	6-0,3	0,4	1/8"	0,88
503101	M - 4	4,3	8-0,36	0,5	5/35"	1,10
503102	M - 5	5,1	9-0,36	0,5	3/16"	1,32
503103	M - 6	6,4	11-0,43	0,7	1/4"	1,54
503104	M - 7	7,4	12,5-0,43	0,8	-	2,97
503105	M - 8	8,2	14-0,43	0,8	5/16"	3,52

Ref.	Para Ø	d1 mm	d2 mm	S1±0,1 mm	Rosca W	€/100
503106	M - 10	10,5	18-0,43	0,9	3/8"	4,40
503107	M - 12	12,5	20,5-0,52	1	-	6,93
503108	M - 14	14,5	24-0,52	1	9/16"	10,78
503109	M - 16	16,5	26-0,52	1,2	5/8"	13,09
503110	M - 18	19	30-0,52	1,4	-	22,00
503111	M - 20	21	33-0,62	1,4	3/4"	23,54

DIN 6798 forma J arandela en abanico



Acero para muelles. HRc 37/43 [HV 365-425]. Aceitado antioxidante.

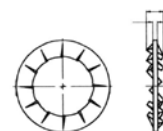

Ref.	d1 mm	d2 mm	Para Ø	Rosca W	S mm	€/100
503300	3,2	6-0,3	M - 3	1/8"	0,4	0,99
503301	4,3	8-0,36	M - 4	5/35"	0,5	1,10
503302	5,1	9-0,36	M - 5	3/16"	0,5	1,21
503303	6,4	11-0,43	M - 6	-	0,7	1,54
503304	7,4	12,5-0,43	M - 7	5/32"	0,8	2,97
503305	8,2	14-0,43	M - 8	5/16"	0,8	3,19
503306	10,5	18-0,43	M - 10	3/8"	0,9	4,95

Ref.	d1 mm	d2 mm	Para Ø	Rosca W	S mm	€/100
503307	12,5	20,5-0,52	M - 12	-	1	7,70
503308	13,2	22-0,52	-	1/2"	1	11,55
503309	14,5	24-0,52	M - 14	-	1	11,99
503310	16,5	26-0,52	M - 16	5/8"	1,2	14,52
503311	19	30-0,52	M - 18	-	1,4	24,53
503312	21	33-0,62	M - 20	-	1,4	29,15

DIN 6917 arandela en cuña. Para uniones HV

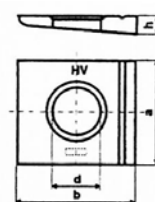

Ref.	d mm	a mm	b mm	h mm	€/100
503650	12	26	30	6,2	4.466,98
503651	16	32	36	7,5	5.411,78
503652	20	40	44	9,2	7.813,28

Ref.	d mm	a mm	b mm	h mm	€/100
503653	22	44	50	10	10.458,28
503654	24	56	56	10,8	15.089,84
503655	27	56	56	10,8	16.938,88

DIN 6918 arandela en cuña. Para uniones HV

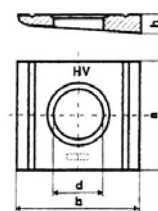

Ref.	b mm	d mm	h mm	a mm	€/100
503660	30	12	4,9	26	3.858,16
503661	36	16	5,9	32	4.807,46
503662	44	20	7	40	6.816,60

Ref.	b mm	d mm	h mm	a mm	€/100
503663	50	22	8	44	9.060,22
503664	56	24	8,5	56	12.602,70
503665	56	27	8,5	56	13.930,84

DIN 137 forma A arandela de muelle



Acero para muelles. HRc 43/50 [HV 425-510]. Aceitado antioxidante.

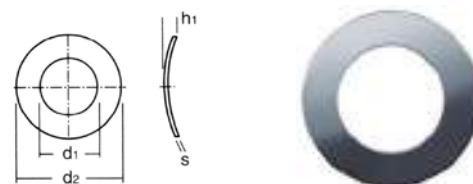

Ref.	d1 mm	d2 mm	h2 máx	h2 mín	s1 mm	€/100
503600	2,2 + 0,25	4,5±0,37	1	0,50	0,3±0,03	1,76
503601	2,5 + 0,25	5±0,37	1	0,50	0,3±0,03	1,87
503602	3,2 + 0,3	6±0,37	1,3	0,65	0,4±0,05	1,98
503603	4,3 + 0,3	8±0,45	1,6	0,80	0,5±0,05	2,09
503604	5,3 + 0,3	10±0,45	1,8	0,90	0,5±0,05	2,20

Ref.	d1 mm	d2 mm	h2 máx	h2 mín	s1 mm	€/100
503605	6,4 + 0,36	11±0,45	2,2	1,10	0,5±0,05	2,31
503606	7,4 + 0,36	12±0,45	2,4	1,20	0,5±0,05	3,08
503607	8,4 + 0,36	15±0,45	3,4	1,70	0,5±0,05	3,19
503608	10,5 + 0,43	18±0,45	4	2	0,8±0,06	6,05

DIN 137 forma B arandela de muelle



Acero para muelles. HRc 43/50 [HV 425-510]. Aceitado antioxidante.



Ref.	d1 mm	d2 mm	h2 máx	h2 mín	s1 mm	€/100
503700	3,7 + 0,3	8 ± 0,45	1,8	0,9	0,5 ± 0,03	3,08
503701	4,3 + 0,3	9 ± 0,45	2	1	0,5 ± 0,03	3,19
503702	5,3 + 0,3	11 ± 0,55	2,2	1,1	0,5 ± 0,05	3,41
503703	6,4 + 0,36	12 ± 0,55	2,6	1,3	0,5 ± 0,05	3,96
503704	7,4 + 0,36	14 ± 0,55	3	1,5	0,8 ± 0,05	5,83
503705	8,4 + 0,36	15 ± 0,55	3	1,5	0,8 ± 0,05	6,38

Ref.	d1 mm	d2 mm	h2 máx	h2 mín	s1 mm	€/100
503706	10,5 + 0,43	21 ± 0,65	4,2	2,1	1 ± 0,05	10,23
503707	13 + 0,43	24 ± 0,65	5	2,5	1,2 ± 0,05	15,40
503708	15 + 0,43	28 ± 0,65	5,9	3	1,6 ± 0,05	23,98
503709	17 + 0,43	30 ± 0,65	6,3	3,2	1,6 ± 0,06	28,60
503710	19 + 0,52	34 ± 0,80	6,5	3,3	1,6 ± 0,06	35,42

DIN 2093 serie A arandela de muelle (dura)



Acero para muelles. HRc 43/50 [HV 425-510]. Aceitado antioxidante.

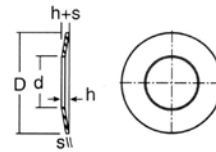

Ref.	D mm	d mm	s mm	h mm	h+s mm	€/100
503800	8	4,2	0,4	0,2	0,6	44,48
503801	10	5,2	0,5	0,25	0,75	55,08
503802	12,5	6,2	0,7	0,3	1	64,96
503803	14	7,2	0,8	0,3	1,1	86,40
503804	16	8,2	0,9	0,35	1,25	88,04
503805	18	9,2	1	0,4	1,4	108,08
503806	20	10,2	1,1	0,45	1,55	140,06
503807	22,5	11,2	1,25	0,5	1,75	191,84
503808	25	12,2	1,5	0,55	2,05	224,44
503809	28	14,2	1,5	0,65	2,15	319,70
503810	31,5	16,3	1,75	0,7	2,45	452,22

Ref.	D mm	d mm	s mm	h mm	h+s mm	€/100
503811	35,5	18,3	2	0,8	2,8	629,84
503812	40	20,4	2,25	0,9	3,15	900,66
503813	45	22,4	2,5	1	3,5	1.376,88
503814	50	25,4	3	1,1	4,1	2.062,10
503815	56	28,5	3	1,3	4,3	2.541,64
503816	63	31	3,5	1,4	4,9	3.727,38
503817	71	36	4	1,6	5,6	7.118,58
503818	80	41	5	1,7	6,7	10.882,20
503819	90	46	5	2	7	13.238,60
503820	100	51	6	2,2	8,2	49.866,30
503821	112	57	6	2,5	8,5	65.263,50

DIN 2093 serie B arandela de muelle (blanda)



Acero para muelles. HRc 43/50 [HV 425-510]. Aceitado antioxidante.

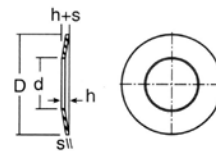

Ref.	d mm	h mm	h+s mm	S mm	D mm	€/100
503900	8	0,25	0,55	0,30	8	28,78
503901	10	0,30	0,7	0,40	10	43,30
503902	12,5	0,35	0,85	0,50	12,5	46,14
503903	14	0,40	0,9	0,50	14	84,66
503904	16	0,45	1,05	0,60	16	92,28
503905	18	0,50	1,2	0,70	18	100,54
503906	20	0,55	1,35	0,80	20	104,50
503907	22,5	0,65	1,45	0,80	22,5	151,60
503908	25	0,70	1,6	0,90	25	153,96
503909	28	0,80	1,8	1	28	254,20
503910	31,5	0,90	2,15	1,25	31,5	325,32

Ref.	d mm	h mm	h+s mm	S mm	D mm	€/100
503911	35,5	1	2,25	1,25	35,5	377,36
503912	40	1,15	2,65	1,50	40	584,04
503913	45	1,30	3,05	1,75	45	925,12
503914	50	1,40	3,4	2	50	1.449,12
503915	56	1,60	3,6	2	56	1.770,12
503916	63	1,75	4,25	2,50	63	2.688,26
503917	71	2	4,5	2,50	71	4.429,34
503918	80	2,30	5,3	3	80	6.789,00
503919	90	2,50	6	3,50	90	9.811,12
503920	100	2,80	6,3	3,50	100	11.650,10
503921	112	3,20	7,2	4	112	16.194,76

DIN 6799 arandela de seguridad para ejes



Ref.	d1 mm	d2 mm	d3 mm	S mm	ah10 mm	€/100
515000	1,2	2,9	3	0,3	1,01	2,99
515001	1,5	3,9	4	0,4	1,28	2,42
515002	1,9	4,4	4,5	0,5	1,61	1,96
515003	2,3	5,9	6	0,6	1,94	2,07
515004	3,2	6,85	7	0,6	2,7	2,19
515005	4	8,85	9	0,7	3,34	2,30
515006	5	10,85	11	0,7	4,11	2,65
515007	6	11,85	12	0,7	5,26	3,34

Ref.	d1 mm	d2 mm	d3 mm	S mm	ah10 mm	€/100
515008	7	13,8	14	0,9	5,84	4,03
515009	8	15,8	16	1	6,52	5,29
515010	9	18,3	18,5	1,1	7,63	6,56
515011	10	19,8	20	1,2	8,32	8,51
515012	12	22,7	23	1,3	10,45	14,26
515013	15	28,7	29	1,5	12,61	24,15
515014	19	36,6	37	1,75	15,92	34,50
515015	24	43,6	44	2	21,88	56,35



DIN 471 E anillo de seguridad para ejes

MIKALOR



Ref.	b= mm	d3 mm	d5 mín mm	Ø mm	S mm	a max mm	€/100
504000	0,8	2,7+0,04/-0,15	1	3	0,4-0,05	1,9	2,42
504001	0,9	3,7+0,04/-0,15	1	4	0,4-0,05	2,2	2,48
504002	1,1	4,7+0,04/-0,15	1	5	0,6-0,05	2,5	2,53
504003	1,3	5,6+0,04/-0,15	1,2	6	0,7-0,05	2,7	2,65
504004	1,4	6,5+0,06/-0,18	1,2	7	0,8-0,05	3,1	3,11
504005	1,5	7,4+0,06/-0,18	1,2	8	0,8-0,05	3,2	3,34
504006	1,7	8,4+0,06/-0,18	1,2	9	1-0,06	3,3	3,68
504007	1,8	9,3+0,10/-0,36	1,2	10	1-0,06	3,3	3,80
504008	1,8	10,2+0,10/-0,36	1,5	11	1-0,06	3,3	4,49
504009	1,8	11+0,10/-0,36	1,5	12	1-0,06	3,3	4,60
504010	2	11,9+0,10/-0,36	1,7	13	1-0,06	3,4	5,29
504011	2,1	12,9+0,10/-0,36	1,7	14	1-0,06	3,5	5,75
504012	2,2	13,8+0,10/-0,36	1,7	15	1-0,06	3,6	6,10
504013	2,2	14,7+0,10/-0,36	1,7	16	1-0,06	3,7	6,44
504014	2,3	15,7+0,10/-0,36	1,7	17	1-0,06	3,8	7,36
504015	2,4	16,5+0,10/-0,36	1,7	18	1,2-0,06	3,9	8,86
504016	2,5	17,5+0,10/-0,36	2	19	1,2-0,06	3,9	9,78
504017	2,6	18,5+0,13/-0,42	2	20	1,2-0,06	4	10,93
504018	2,7	19,5+0,13/-0,42	2	21	1,2-0,06	4,1	13,80
504019	2,8	20,5+0,21/-0,42	2	22	1,2-0,06	4,2	14,72
504020	3	22,2+0,21/-0,42	2	24	1,2-0,06	4,4	16,68
504021	3	23,2+0,21/-0,42	2	25	1,2-0,06	4,4	17,25
504022	3,1	24,2+0,21/-0,42	2	26	1,2-0,06	4,5	18,98
504023	3,2	25,9+0,21/-0,42	2	28	1,5-0,06	4,7	20,13
504024	3,4	26,9+0,21/-0,42	2	29	1,5-0,06	4,8	22,43
504025	3,5	27,9+0,21/-0,42	2	30	1,5-0,06	5	23,00
504026	3,6	29,6+0,21/-0,42	2,5	32	1,5-0,06	5,2	25,88
504027	3,8	31,5+0,25/-0,5	2,5	34	1,5-0,06	5,4	27,60
504028	3,9	32,2+0,25/-0,5	2,5	35	1,5-0,06	5,6	29,10
504029	4	33,2+0,25/-0,5	2,5	36	1,75-0,06	5,6	35,65
504030	4,2	35,2+0,25/-0,5	2,5	38	1,75-0,06	5,8	37,38
504031	4,4	36,5+0,39/-0,9	2,5	40	1,75-0,06	6	39,10
504032	4,5	38,5+0,39/-0,9	2,5	42	1,75-0,06	6,5	43,70
504033	4,7	41,5+0,39/-0,9	2,5	45	1,75-0,06	6,7	48,30
504034	5	44,5+0,39/-0,9	2,5	48	1,75-0,06	6,9	54,05
504035	5,1	45,8+0,39/-0,9	2,5	50	2-0,07	6,9	56,35
504036	5,2	47,8+0,39/-0,9	2,5	52	2-0,07	7	62,10
504037	5,4	50,8+0,46/-1,1	2,5	55	2-0,07	7,2	64,40
504038	5,5	51,8+0,46/-1,1	2,5	56	2-0,07	7,3	72,45
504039	5,6	53,8+0,46/-1,1	2,5	58	2-0,07	7,3	78,20
504040	5,8	55,8+0,46/-1,1	2,5	60	2-0,07	7,4	79,35
504041	6	57,8+0,46/-1,1	2,5	62	2-0,07	7,5	81,65
504042	6,2	58,8+0,46/-1,1	2,5	63	2-0,07	7,6	86,25
504043	6,3	60,8+0,46/-1,1	3	65	2,5-0,07	7,8	102,35
504044	6,5	63,5+0,46/-1,1	3	68	2,5-0,07	8	123,05
504045	6,6	65,5+0,46/-1,1	3	70	2,5-0,07	8,1	125,35
504046	6,8	67,5+0,46/-1,1	3	72	2,5-0,07	8,2	135,70
504047	7	70,5+0,46/-1,1	3	75	2,5-0,07	8,4	141,45
504048	7,3	73,5+0,46/-1,1	3	78	2,5-0,07	8,6	143,75
504049	7,4	74,5+0,46/-1,1	3	80	2,5-0,07	8,6	148,35
504050	7,6	76,5+0,46/-1,1	3	82	2,5-0,07	8,7	157,55
504051	7,8	79,5+0,46/-1,1	3,5	85	3-0,07	8,7	201,25
504052	8,2	84,5+0,54/-1,08	3,5	90	3-0,07	8,8	224,25
504053	8,6	89,5+0,54/-1,08	3,5	95	3-0,07	9,4	238,05
504054	9	94,5+0,54/-1,08	3,5	100	3-0,07	9,6	270,25
504055	9,3	98+0,54/-1,08	3,5	105	4-0,07	9,9	494,50
504056	9,6	103+0,54/-1,08	3,5	110	4-0,07	10,1	529,00
504057	9,8	108+0,54/-1,08	3,5	115	4-0,07	10,6	575,00
504058	10,2	113+0,54/-1,08	3,5	120	4-0,07	11	586,50
504059	10,4	118+0,54/-1,08	4	125	4-0,07	11,4	632,50
504060	10,7	123+0,63/-1,26	4	130	4-0,07	11,6	678,50
504061	11	128+0,63/-1,26	4	135	4-0,07	11,8	713,00
504062	11,2	133+0,63/-1,26	4	140	4-0,07	12	759,00
504063	11,5	138+0,63/-1,26	4	145	4-0,07	12,2	805,00
504064	11,8	142+0,63/-1,26	4	150	4-0,07	13	862,50

DIN 472 I anillo de seguridad para ejes

MIKALOR

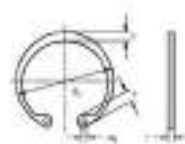

Ref.	b= mm	d3 mm	d5 mín mm	Ø mm	S mm	a max mm	€/100
504100	0,8	8,7 + 0,36/-0,10	1	8	0,8 - 0,05	2,4	3,34
504101	0,9	9,8 + 0,36/-0,10	1	9	0,8 - 0,05	2,5	3,57
504102	1,1	10,8 + 0,36/-0,10	1,2	10	1 - 0,06	3,2	4,03
504103	1,3	11,8 + 0,36/-0,10	1,2	11	1 - 0,06	3,3	4,26
504104	1,4	13 + 0,36/-0,10	1,5	12	1 - 0,06	3,4	4,37
504105	1,5	14,1 + 0,36/-0,10	1,5	13	1 - 0,06	3,6	4,49
504106	1,7	15,1 + 0,36/-0,10	1,7	14	1 - 0,06	3,7	4,83
504107	1,8	16,2 + 0,36/-0,10	1,7	15	1 - 0,06	3,7	5,52
504108	1,8	17,3 + 0,36/-0,10	1,7	16	1 - 0,06	3,8	6,10
504109	1,8	18,3 + 0,42/-0,13	1,7	17	1 - 0,06	3,9	7,13
504110	2	19,5 + 0,42/-0,13	2	18	1 - 0,06	4,1	7,59
504111	2,1	20,5 + 0,42/-0,13	2	19	1 - 0,06	4,1	8,28
504112	2,2	21,5 + 0,42/-0,13	2	20	1 - 0,06	4,2	8,97
504113	2,2	22,5 + 0,42/-0,13	2	21	1 - 0,06	4,2	9,66
504114	2,3	23,5 + 0,42/-0,13	2	22	1 - 0,06	4,2	10,24
504115	2,4	25,9 + 0,42/-0,21	2	24	1,2 - 0,06	4,4	12,65
504116	2,5	26,9 + 0,42/-0,21	2	25	1,2 - 0,06	4,5	13,80
504117	2,6	27,9 + 0,42/-0,21	2	26	1,2 - 0,06	4,7	16,10
504118	2,7	30,1 + 0,5/-0,25	2,5	28	1,2 - 0,06	4,8	17,25
504119	2,8	32,1 + 0,5/-0,25	2,5	30	1,2 - 0,06	4,8	18,40
504120	3	33,4 + 0,5/-0,25	2,5	31	1,2 - 0,06	5,2	19,55
504121	3	34,4 + 0,5/-0,25	2,5	32	1,2 - 0,06	5,4	20,70
504122	3,1	36,5 + 0,5/-0,25	2,5	34	1,5 - 0,06	5,4	21,85
504123	3,2	37,8 + 0,5/-0,25	2,5	35	1,5 - 0,06	5,4	23,00
504124	3,4	38,8 + 0,5/-0,25	2,5	36	1,5 - 0,06	5,4	24,15
504125	3,5	39,8 + 0,5/-0,25	2,5	37	1,5 - 0,06	5,5	27,60
504126	3,6	40,8 + 0,5/-0,25	2,5	38	1,5 - 0,06	5,5	28,75
504127	3,8	43,5 + 0,9/-0,39	2,5	40	1,5 - 0,06	5,8	33,35
504128	3,9	45,5 + 0,9/-0,39	2,5	42	1,5 - 0,06	5,9	36,80
504129	4	48,5 + 0,9/-0,39	2,5	45	1,75 - 0,06	6,2	37,95
504130	4,2	50,5 + 1,1/-0,46	2,5	47	1,75 - 0,06	6,4	42,55
504131	4,4	51,5 + 1,1/-0,46	2,5	48	1,75 - 0,06	6,4	46,00
504132	4,5	54,2 + 1,1/-0,46	2,5	50	2 - 0,07	6,5	47,15
504133	4,7	56,2 + 1,1/-0,46	2,5	52	2 - 0,07	6,7	48,30
504134	5	59,2 + 1,1/-0,46	2,5	55	2 - 0,07	6,8	62,10
504135	5,1	60,2 + 1,1/-0,46	2,5	56	2 - 0,07	6,8	64,40
504136	5,2	62,2 + 1,1/-0,46	2,5	58	2 - 0,07	6,9	66,70
504137	5,4	64,2 + 1,1/-0,46	2,5	60	2 - 0,07	7,3	69,00
504138	5,5	66,2 + 1,1/-0,46	2,5	62	2 - 0,07	7,3	72,45
504139	5,6	67,2 + 1,1/-0,46	2,5	63	2 - 0,07	7,3	77,05
504140	5,8	69,2 + 1,1/-0,46	3	65	2,5 - 0,07	7,6	100,05
504141	6	72,5 + 1,1/-0,46	3	68	2,5 - 0,07	7,8	111,55
504142	6,2	74,5 + 1,1/-0,46	3	70	2,5 - 0,07	7,8	110,40
504143	6,3	76,5 + 1,1/-0,46	3	72	2,5 - 0,07	7,8	113,85
504144	6,5	79,5 + 1,1/-0,46	3	75	2,5 - 0,07	7,8	124,20
504145	6,6	82,5 + 1,3/-0,54	3	78	2,5 - 0,07	8,5	128,80
504146	6,8	85,5 + 1,3/-0,54	3	80	2,5 - 0,07	8,5	134,55
504147	7	87,5 + 1,3/-0,54	3	82	2,5 - 0,07	8,5	138,00
504148	7,3	90,5 + 1,08/-0,54	3,5	85	3 - 0,07	8,6	161,00
504149	7,4	95,5 + 1,08/-0,54	3,5	90	3 - 0,07	8,6	178,25
504150	7,6	100,5 + 1,08/-0,54	3,5	95	3 - 0,07	8,8	195,50
504151	7,8	100,5 + 1,08/-0,54	3,5	100	3 - 0,07	9	230,00
504152	8,2	112 + 1,08/-0,54	3,5	105	4 - 0,07	9,5	379,50
504153	8,6	117 + 1,08/-0,54	3,5	110	4 - 0,07	10,4	391,00
504154	9	122 + 1,26/-0,63	3,5	115	4 - 0,07	10,5	425,50
504155	9,3	127 + 1,26/-0,63	3,5	120	4 - 0,07	11	448,50
504156	9,6	132 + 1,26/-0,63	4	125	4 - 0,07	11	517,50
504157	9,8	137 + 1,26/-0,63	4	130	4 - 0,07	11	540,50
504158	10,2	142 + 1,26/-0,63	4	135	4 - 0,07	11,2	592,25
504159	10,4	147 + 1,26/-0,63	4	140	4 - 0,07	11,2	644,00
504160	10,7	152 + 1,26/-0,63	4	145	4 - 0,07	11,4	690,00
504161	11	158 + 1,26/-0,63	4	150	4 - 0,07	12	724,50

06



630
Protección de cabeza

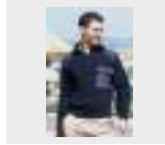

678
Polares y Jerseys



712
Guantes para riesgo químico



635
Protección facial



679
Chaqueta polar



716
Guantes para riesgo mecánico



637
Protección soldadura



685
Ropa anti-frío



736
Guantes anti-corte



641
Gafas

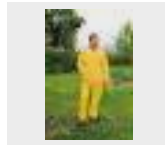

685
Ropa para agua



743
Guantes soldador



648
Gafas para soldar

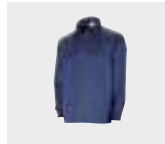

686
Ropa ignifuga y antiestática



Protección de los pies



648
Buzos



688
Ropa desechable



781
Protección anticaídas



649
Pantalones



689
Ropa alta visibilidad



785
Absorbedores anti caídas

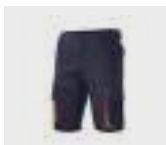

659
Bermudas



702
Ropa de soldador



792
Lineas de vida



663
Camisetas y Polos

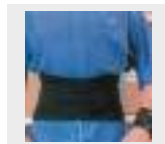

703
Ergonómicos



794
Ducha lava-ojos



669
Chalecos



705
Guantes desechables

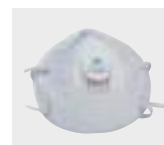

794
Mascarillas



675
Cazadoras



709
Guantes para alimentación

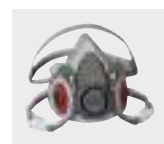

796
Máscaras

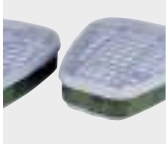

798
Filtros



801
Equipos
motorizados



804
Tapones



806
Orejeras



807
Antideslizantes



808
Absorbentes



809
Consignación



811
Esquineras

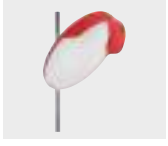

811
Espejos



815
Cintas de
baliza



817
Señales
metálicas

07 PROTECCIÓN LABORAL



Casco ligero en ABS TIRRENO TXR



Fabricado con ABS inyectado de gran calidad con estabilización ultravioleta. Arnés Interior: Tiras textiles con 4 puntos de anclaje (disponible también en 6 puntos). Peso: 316 g. La tira de nuca se ajusta con guía dentada.



Ref.	Código	Color	€/ u.	Ref.	Código	Color	€/ u.
1000106	2451070201	Blanco	15,54	1000105	2451070204	Rojo	15,54
1000108	2451070202	Amarillo flúor	15,54	1000104	2451070205	Azul	15,54
1000107	2451070203	Verde flúor	15,54	1000109	2451070207	Naranja flúor	15,54

Casco para uso eléctrico hasta 1000V. 5-RG



Manufacturado de polietileno inyectado de gran densidad. Arnés de cabeza: Arnés de cabeza con 6 puntos de anclaje y la tira de nuca se ajusta con guía dentada. Peso: 320-347 gr.



Ref.	Código	Color	€/ u.	Ref.	Código	Color	€/ u.
1000304	2451050101	Blanco	7,81	1000307	2451050104	Rojo	7,81
1000305	2451050102	Amarillo	7,81	1000306	2451050105	Azul	7,81
1000308	2451050103	Verde	7,81	1000310	2451050107	Naranja	7,81

Casco de polietileno para uso eléctrico hasta 1000V. 5-RS



Fabricado con polietileno inyectado de gran densidad. Arnés de cabeza: Arnés de cabeza con 6 puntos de anclaje y ajuste manual. Peso: 320-347 gr.



Ref.	Código	Color	€ / u.
1000000	2451005101	Blanco	3,60
1000001	2451005102	Amarillo	3,60
1000004	2451005103	Verde	3,60
1000003	2451005104	Rojo	3,60

Ref.	Código	Color	€ / u.
1000002	2451005105	Azul	3,60
1000005	2451005106	Gris	3,60
1000006	2451005107	Naranja	3,60

Casco CADi



Fabricado en ABS con estabilización ultravioleta de gran calidad. Protección interior de poliestireno de gran densidad. Relleno interior. Banda de cabeza ajustable con rueda dentada. Orificios de ventilación. Barboquejo textil con 4 puntos de anclaje.

Ref.	Código	Color	€ / u.
1015025	2451008102	Amarillo	67,76
1015002	2451008105	Azul	67,76
1015000	2451008101	Blanco	67,76



Casco CURRO



El casco CURRO está especialmente diseñado para ser utilizado en trabajos en altura, emergencias y espacios confinados gracias a la ausencia de visera y a su barboquejo en Y de 4 puntos de anclaje. Conforme a su homologación EN 397:2001+AI:2012 también es óptimo para su uso en otros ámbitos tales como industria, construcción, obra pública, forestales, naviero, etc.

Ref.	Código	Color	€ / u.
2401050	2451011301	Blanco	25,47
2401051	2451011302	Amarillo flúor	25,47
2401052	2451011305	Azul	25,47



Casco OREKA



Casco para trabajos en altura polivalente y con diseño deportivo. Este casco ofrece una comodidad única gracias al arnés interior de seis puntos, cinco soportes portalámparas, una fijación con trinquete para un ajuste más simple, rápido y efectivo que garantizan una excelente sujeción del casco en la cabeza. El casco Oreka cuenta con una gran versatilidad, pudiendo adaptarse visor de protección, pantalla protectora facial y protección auditiva (ranura de 30mm universal). Contiene orificios de ventilación con mecanismo deslizante que permite al usuario tapar dichos orificios. Casquete exterior fabricado en ABS.



Ref.	Código	Color	€ / u.
2401053	102601300033	Blanco	54,20
2401054	102601300035	Rojo	54,20
2401055	102601300036	Azul	54,20
2401056	102601300037	Negro	54,20
2401057	102601300038	Rosa	54,20
2401058	102601300039	Verde	54,20
2401059	102601300034	Amarillo	54,20
2401060	102601300040	Naranja	54,20
2401061	102601300067	Amarillo alta visibilidad	64,90

Casco MAKALU91



Su construcción se basa en una carcasa de EPS y una lámina de policarbonato (tecnología In-mold) que aumenta su durabilidad y lo convierte en un modelo muy versátil y ultraligero al contar con un peso de 224 gramos.



Ref.	Código	Color	€ / u.
2401062	2451019101	Blanco	89,89
2401063	2451019107	Naranja	89,89
2401064	2451019108	Negro	89,89

Accesorios



Ref.	Código	Descripción	Modelo	€ / u.
1015031	2501005100	Arnés de cabeza para casco mod. 5RS, con 6 puntos y banda de sudor reemplazable. Hecho de polietileno de baja densidad. Ajuste automático.	Arnés 5-RS	2,48
1015032	2501005200	Arnés de cabeza para casco mod. 5RG, con 6 puntos y banda de sudor reemplazable. Hecho de polietileno de baja densidad. Ajuste automático.	Arnés 5-RG	5,14
1015033	2501007200	Arnés de cabeza para casco mod. Tirreno TXR. Hecho de polietileno de baja densidad y tiras textiles. 4 puntos y banda de sudor reemplazable. Ajuste automático.	Arnés TIRRENO TXR	7,33
1015034	2501005501	Barboquejo para todos los modelos de cascos		1,90
1015035	2501005500	Barboquejo con mentonera para todos los modelos de cascos		1,18
2401065	2501005600	Banda antisudor RS/RG		0,26

Gorra antigolpes



Fabricada en poliamida y equipada con una protección interior en PE y con almohadilla protectora.

Ref.	Código	Modelo	€/u.
1015040	2452001102000	Gorra GA (amarilla)	17,86
1000055	2452001100000	Gorra GN (naranja / negra)	17,86
1015042	2452001104000	Gorra GR (roja / negra)	17,23



Casco de seguridad 3M™ G3000 UVICATOR™



El casco de protección G3000 ha sido concebido para ser utilizado en entornos duros y con severas exigencias de protección eficaz. El casco G3000 tiene excelente ventilación, buen campo de visión y es uno de los pocos cascos ligeros disponibles actualmente en el mercado. Material: ABS con estabilización UV. Con ruleta y banda de sudor. Colores: gris, amarillo, blanco, naranja, rojo, azul y verde. Peso: 310 gr (estándar), 334 gr (ruleta). Tamaño: 54-62 cm.



Ref.	Código	Color	€/u.
1015100	7000039719	Azul	27,60
1015101	7000108316	Verde HV	27,60
1015102	7000108315	Verde	27,60
1015103	7000009701	Amarillo	27,60
1015104	7000039720	Naranja	27,60
1015105	7000039721	Rojo	27,60
1015106	7100001960	Blanco	27,60

Casco de seguridad 3M™ Serie H-700



El casco 3M™ H-700 es cómodo y resistente. Diseñado con un perfil bajo para mejorar la estabilidad y el rendimiento, la serie H-700 se ha desarrollado para ofrecer la máxima comodidad durante el turno completo sin comprometer la protección contra pequeños objetos que golpean la parte superior del casco. Barbuquejo de 2 puntos para mayor seguridad.

Arnés girable 180°: Mayor confort y seguridad en espacios estrechos.

También se gira para ser utilizado en combinación con Pantalla de soldadura.

Protección ocular integrada: Alto ajuste & confort.

Mejora la seguridad.

Visera corta: Mejora la visibilidad.

Ventilación repartida: Mayor confort.

Arnés de ruleta: Más flexibilidad y confort.

Compatible con otros EPIS 3M (Pantalla V4, protección ocular V6, orejeras, barbuquejo de 2 puntos).

Peso: Estándar: 356 g.

Ruleta: 378 g.

Resistencia UV: HDPE estabilizado para el UV.

Material: HDPE (High Density Polyethylene).

Temperatura: -30 to +50° C [-50°C in Russia].

Salpicaduras de metales fundidos MM.

Aislamiento eléctrico: 440 Vac / (EN397) - 1000V / (EN50365).

Arnés con giro de 180°: Sin marcado especial.



Ref.	Código	Ventilación	Color	€/u.
1000088	7000104208	Si	Blanco	18,90
1000089	7000104209	Si	Amarillo	18,90
1000090	7000104210	Si	Azul	18,90
1000091	7000104211	Si	Verde	18,90
1000092	7000104212	Si	Rojo	18,90
1000093	7000104213	Si	Naranja	18,90

07

Casco de seguridad 3M™ Serie G3501 alta temperatura



El casco de seguridad 3M™ G3501 es un casco ligero y duradero. Aprobado para utilización en un rango de temperaturas entre entre -30° y por encima de +150°. Cumple con los requisitos de la norma EN50365 sobre aislamiento eléctrico. Está disponible en 6 colores, con arnés de ruleta. Material: nylon reforzado con fibras de vidrio. Sin ventilación y con ruleta y banda de sudor. Colores: amarillo, blanco, naranja, rojo, azul y verde. Peso: 369 g (estandar). 392 g (ruleta).



Ref.	Código	Color	€/ u.
1002821	7100077208	Blanco	46,00
1002822	7100077280	Amarillo	46,00
1002823	7100077179	Rojo	46,00
1002824	7100077281	Verde	46,00
1002825	7100077171	Azul	46,00
1002826	7100077212	Naranja	46,00

Casco de seguridad 3M™ Serie G3501 alta temperatura. Complementos



Ref.	Código	Descripción	€/ u.
1002830	7100082482	5XGIR5 Pantalla para alta temperatura y radiaciones IR, dorada, policarbonato, Tono 5.	150,64
1002831	7100082483	NC1GR Protector de nuca y cuello para casco, algodón y para -aramida.	71,08
1002832	7100082484	NCIAL Protector de nuca y cuello para casco, aluminizado.	89,17
1002833	7100082485	FC1GR Protector frontal para casco, algodón y para-aramida.	91,28
1002834	7100082486	FCIAL Protector frontal para casco, aluminizado.	94,25

3M™ First Base™ + Bump Caps



Disponibles en una gama de colores y longitudes de visera, estas gorras de protección son ideales para trabajadores de los sectores de automoción, aeroespacial, procesamiento de alimentos, transporte y logística. Diseñadas con el confort y la elegancia en mente permitiendo la ventilación de aire.



Ref.	Código	Color	Tamaño visera mm	€/ u.
21003000	7100217750	Navy Blue	75	20,45
21003006	7100217836	Navy Black	55	36,00
21003007	7100217837	Navy Black	70	36,00
21003008	7100217838	Royal Blue	55	36,00

Pantalla



425



CLIMAX 10



324 RG



324 RG/N

Ref.	Código	Descripción	Modelo	€ / u.
1000405	2104425100	Visor: Malla metálica. 200 x 280 mm	425	18,48
1015071	2104010100	Visor de malla metálica. 200 x 280 mm. Protector auditivo mod. 10 (22 db) EN 352 EN1731	CLIMAX 10	28,43
21027000	21043243000	Diseñada para ofrecer una efectiva protección contra el riesgo de impacto de partículas a alta velocidad y media energía y como protección contra gotas y salpicaduras de líquidos. Resistencia a la radiación UV. Visor de policarbonato incoloro. Clase óptica 1. EN 166:2001 / EN 170:2002 CE. Anti ralladuras.	324 RG	19,22
21027001	21043241000	Diseñada para ofrecer una efectiva protección contra el riesgo de impacto de partículas a alta velocidad y media energía y como protección contra gotas y salpicaduras de líquidos. Resistencia a la radiación UV. Visor de policarbonato incoloro. Clase óptica 1. EN 166:2001 / EN 170:2002 CE. Anti vaho y anti ralladuras.	324 RG/N	22,80

Pantalla, visor protección facial. Sistemas Adaptadores 3M™ V4 y V5. Sistema Adaptador 3M™ V4



V4A



V4D



V4JK SV



V4D



V4KK

Ref.	Código	Descripción	€ / u.
1015152	7100046846	V4A Pantalla rejilla metalizada, reducción luminica 35%	18,42
1015153	7000107736	V4B Pantalla rejilla nylon, reducción luminica 45%	19,73
1015150	7000108160	V4C Pantalla rejilla acero inoxidable, reducción luminica 25%	21,85
1015151	7000107737	V4CK Pantalla rejilla acero inox. visera corta, reducc. luminica 25%	22,48
1015156	7000107738	V4JSV Pantalla rejilla acero inox. efecto grabado, visera corta	39,34
1015157	7000039612	V4D Pantalla acetato incolora	32,41
1015159	7000107740	V4F Pantalla policarbonato incolora	21,57
1015161	7000039613	V4H Pantalla policarbonato incolora 1,2 mm	25,56
1015162	7000038213	V4KK Pantalla policarbonato incolora larga 1,5 mm	27,41
1015163	7000108162	V4DK Pantalla acetato incolora visera corta	30,91
1015164	7000108165	V4FK Pantalla policarbonato incolora visera corta	24,40
1015165	7000108166	V4HK Pantalla policarbonato incolora 1,2 mm visera corta	30,91

Pantalla, visor protección facial. Sistemas Adaptadores 3M™ V4 y V5. Sistema Adaptador 3M™ V5



El Sistema adaptador 3M™ V5 se puede montar sobre el casco de seguridad industrial 3M™ G22, G2000 o G3000 para permitir la fijación de diversos protectores faciales. Este producto de alta calidad proporciona protección contra los impactos en la parte frontal y lateral.



Ref.	Código	Descripción	€/ u.
1002837	7100082482	5XGIR5 Pantalla para alta temperatura y radiaciones ir, dorada, policarbonato, tono 5.	150,64
1002836	7100029680	5F-11 Pantalla incolora de policarbonato para G500, antiempañamiento por las dos caras	16,12
1002838	7000103791	5B Pantalla de rejilla de poliamida para G500	14,20
1002839	7000103792	5C-1 Pantalla de rejilla de acero inoxidable para G500	15,27
1002840	7000103793	5J-1 Pantalla de rejilla de acero inoxidable de máxima visibilidad para G500	38,04

Arnés 3M™ Serie G500. Combinación forestal



Ref.	Código	Descripción	€/ u.
1000110	7000103820	G500 Combinación forestal: arnés G500-or, Pantalla 5J y orejeras Optime I (p3e) naranja	100,04
1000111	7000103790	G500 Combinación forestal: arnés G500, 5c-1, optime i (p3e) naranja	75,69
1000112	7000103791	5B Pantalla de rejilla de poliamida para G500	14,20
1000113	7000103792	5C-1 Pantalla de rejilla de acero inoxidable para G500	15,27
1000114	7000103793	5J-1 Pantalla de rejilla de acero inoxidable de máxima visibilidad para G500	38,04
1000115	7000103789	HYG50 Banda de sudor de plástico para cascos 3m Peltor y G500	4,86

Arnés 3M™ H8



Este duradero arnés se utiliza como soporte para distintas Pantalla. Es resistente a impactos y puede usarse en una amplia gama de temperaturas. El arnés H8, además de un sistema de ruleta en el arnés para un ajuste más seguro y cómodo, tiene un sistema de cambio fácil de la Pantalla y una diadema con cinco posiciones que aumenta la sujeción y el confort.



Ref.	Código	Descripción	€/ u.
1015204	7000144936	H8 arnés 3m con ruleta	35,39
1015205	7000146481	Kit de arnés 3m h8 y Pantalla wp96 pc incolora	48,72
1015200	7100016704	WP96 Pantalla pc incolora	12,78
1015201	7000089416	WP98 Pantalla acetato incolora	24,86

Pantalla de soldadura electrónica



420



415 E

Ref.	Código	Modelo	Descripción	Tiempo de reacción s	€ / u.
1015085	2105420100	420	Pantalla: Poliamida con fibra de vidrio de gran resistencia. Filtro: Auto-oscurrecible que cambia automáticamente de tono 4 a tono 9-13. tiempo de retorno: Bajo 0,0005 s.	0.0005	73,46
1015086	2105421100	421	Pantalla: Poliamida con fibra de vidrio de gran resistencia. Filtro: Auto-oscurrecible que cambia automáticamente de tono 4 a tono 9-13. Batería recambiable. tiempo de retorno: Bajo 0,0005 s. EN 175 EN 169 EN 397	0.0005	83,66
1015087	2103415100	415 E	Casco: Mod. 5RG + Pantalla de soldar con filtro electrónico. EN 175: 1997 EN 379: 1994, EN 397: 1995	0.0005	24,00

Pantalla de soldadura electrónica, visión color



Pantalla preparada para aportar al soldador excelente calidad de VISIÓN EN COLOR y un alto grado de protección de los rayos UV e IR generados por el arco en procesos de soldadura y corte por plasma, no siendo apta para el uso en equipos Láser.



Ref.	Código	Color	Area de visión mm	Tiempo de reacción s	€ / u.
2401066	5998F	Negro	92x43	0.00004	85,00
2401067	5998FC	Fuego Calavera	92x43	0.00004	95,00

Pantalla de soldadura electrónica



HELLMET R-05



HELLMET JOB



HELLMET R-10



HELLMET R-10XL

Ref.	Código	Modelo	Descripción	€ / u.
2401068	10299	HELLMET R-05	Campo de visión: 100x53mm; Clase óptica: 1/1/1/2; Sensores: 4, DIN: 4 / 5-8 / 9-13; Pila sustituible: Si; Visión: COLOR REAL	69,00
2401069	6770	HELLMET JOB	Campo de visión: 100x60mm; Clase óptica: 1/1/1/1; Sensores: 4, DIN: 4 / 5-8 / 9-13; Pila sustituible: Si; Visión: COLOR REAL	99,00
2401070	10044	HELLMET R-10	Campo de visión: 100x60mm; Clase óptica: 1/1/1/1; Sensores: 4, DIN: 4 / 5-8 / 9-13; Pila sustituible: Si; Visión: COLOR REAL	99,00
2401071	10075	HELLMET R-10XL	Campo de visión: 100x100mm; Clase óptica: 1/1/1/1; Sensores: 4, DIN: 4 / 5-8 / 9-13; Pila sustituible: Si; Visión: COLOR REAL	135,00

07



Pantalla de soldadura electrónica



OPTIMATIC 55



OPTIMATIC 100

Ref.	Código	Modelo	Descripción	€/ u.
2401072	6705	OPTIMATIC 55	Campo de visión: 96x39mm; Clase óptica: 1/1/1/2; Sensores: 2, DIN: 4 / 9-13; Pila sustituible: No; Visión: Verde	33,00
2401073	6684	OPTIMATIC 100	Campo de visión: 96x39mm; Clase óptica: 1/1/1/2; Sensores: 2, DIN: 4 / 9-13; Pila sustituible: Si; Visión: Verde	44,00

Arnés 3M™ Serie G500. Combinación industrial



El arnés 3M™ G500 es una solución versátil y cómoda para su uso como sistema independiente de protección facial o sistema combinado de protección facial y auditiva. Las especiales características de diseño del arnés G500 hacen que sea fácil de combinar con otros productos de seguridad de 3M™, como protectores faciales, orejeras pasivas o de comunicación y protectores oculares integrados. Este producto de alta calidad proporciona protección frente a impactos desde la parte frontal y lateral mientras que, una atención especial durante la etapa de diseño, asegura la máxima visibilidad y comodidad del usuario.



Ref.	Código	Descripción	€/ u.
1000095	7100029146	G500 Combinación industrial: arnés G500-gu, Pantalla 5f-11 y orejeras optime i (p3e) amarillo	76,35
1000096	7000038216	G500 Arnés amarillo	34,87
1000097	7100029680	5F-11 Pantalla incolora de policarbonato para G500, antiempañamiento por las dos caras	16,12
1000098	7000103788	5E-11 Pantalla tono 5 de policarbonato para G500	46,34
1000099	7000103789	HYG50 Banda de sudor de plástico para cascos 3m Peltor y G500	4,86

Pantalla de soldadura electrónica



Pantallas de calidad óptica CE/1/1/1/2, de energía solar (reemplazable) con función amolado. Regulación sensibilidad y tiempo retardo, micro ajustable.



SINEX VISION 05



SINEX VISION 10 PRO

Ref.	Código	Modelo	Area de visión mm	Tono claro	Regulable	Tipo visión	€/ u.
2401074	10469	SINEX VISION 05	96x39	DIN 4	DIN 9/13	Verde	37,90
2401075	10470	SINEX VISION 10 PRO	100x53	DIN 4	DIN 5/8 + DIN 9/13	Color real	78,00

07

Pantalla de soldadura gama SPEEDGLAS™.



Las pantalla de soldadura de la gama Speedglas™ incorporan filtros de oscurecimiento automático (filtros ADF) en diferentes versiones. Además tienen opciones como SideWindows (ventanas laterales), frontal plateado (reflectante del calor y la radiación) o un diseño para reducir el CO2 en el interior. Además pueden formar parte de equipos motorizados de protección respiratoria (ADFLO) o equipos de suministro de aire Versafllo V-500. Pantalla de soldadura 3M™ Speedglas™ 100



Pantalla Speedglas 100



Pantalla Speedglas 9100

Pantalla de soldadura 3M™ Speedglas™ 100

Ref.	Código	Modelo	€ / u.
1015302	751120	con filtro ADF 100V tono variable 8-12	254,59

Pantalla de soldadura 3M™ Speedglas™ 9100

Ref.	Código	Modelo	€ / u.
1015353	501805	con ventanas laterales con filtro ADF 9100V (5/8/9-13)	549,01
1015354	501815	con ventanas laterales con filtro ADF 9100X (5/8/9-13)	634,12
1015355	501825	con ventanas laterales con filtro ADF 9100XX (5/8/9-13)	720,28

Pantalla de soldadura electrónica



Pantalla: Poliamida con fibra de vidrio de gran resistencia. Filtro: Auto-oscurecible que cambia automáticamente. EN 175 EN 169 EN 379.



Ref.	Código	Tiempo de reacción s	Tono	€ / u.
21104000	520	0,0005	9-13	30,60

Pantalla de soldadura electrónica



Ref.	Código	Ocular	€ / u.
1002580	2188-PSEAM	Pantalla OPTECH electrónica, gris grafito, azul, roja	59,65



07

Pantalla de soldadura de cabeza



405 CPA



405 CP



405 C



415-A



Ref.	Código	Descripción	Modelo	€ / u.
1015090	2102405700	Polipropileno. Visor ajustable especial (tamaños diferentes). Tonos: de din 8 a din 14	405 CPA	19,47
1015091	2102405600	Polipropileno. Visor fijo (tamaños diferentes). Tonos: de din 8 a din 14	405 CP	14,38
1000605	2102405300	Poliamida zytel. Visor fijo: 110 x 90. Tonos: de din 8 a 16 en 175 en 169	405 C	23,55
1015094	2103415100	Casco 5rg + pantalla de soldar con visor fijo (tamaños diferentes). une-en 397: 1995 Une-en 175: 1997	415 c/amarillo	24,00
1015095	2103415200	Casco 5rg + pantalla de soldar con visor abatible une-en 397: 1995, Une-en 175: 1997	415-A c/amarillo	27,92

Pantalla de soldadura de mano



Ref.	Código	Descripción	Modelo	€ / u.
1000700	2101418100	Fibra de vidrio vulcanizado. Filtros: DIN 8 a DIN 14. Diferentes dimensiones del filtro EN 175: 1997	418-U	17,62

Manta ignífuga



Ref.	Código	Temperatura	Medidas	Uso	€ / u.
2401076	10080	600	2000x900mm	Vertical	45,25
2401077	10082	600	2000x1860mm	Vertical	91,00
2401078	10084	600	1x50m	Vertical	390,00

Manta ignífuga



Ref.	Código	Temperatura	Medidas	Uso	€ / u.
2401079	10081	950	2000x900mm	Vertical+Horizontal	79,00
2401080	10083	950	2000x1860mm	Vertical+Horizontal	159,00
2401081	10085	950	0,9x50m	Vertical+Horizontal	850,00

Cristal de soldadura



Ref.	Código	€ / u.	Ref.	Código	€ / u.
1003156	2201008100	1,66	1003136	2201105212	2,75
1003157	2201013100	1,66	1003137	2201105213	2,75
1003158	2201011200	1,66	1003143	2201110211	2,75
1003131	2201090109	2,75	1003144	2201110212	2,75
1003132	2201090110	2,75	1003150	2201099105	2,75
1003133	2201090111	2,75	1003151	2201099101	2,75
1003134	2201105210	2,75	1003152	2201099104	2,75
1003135	2201105211	2,75	1003154	2201099107	2,75

Gafa panorámica



CE EN 166

595 Transparente



CE EN 166

CE EN 170

595 Amarillo



CE EN 166

595 Gris

Ref.	Código	Descripción	Modelo	€ / u.
1003163	2015595101	Material: Policarbonato. Longitud ajustable de patillas con sistema telescópico. Fuerza mecánica: F	595-I	6,11
1003164	2015595301	Material: Policarbonato amarillo. Longitud ajustable de patillas con sistema telescópico. Tipo de filtro: 2C-1,2. Clase óptica: 2	595-A	6,11
1003165	2015595201	Material: Policarbonato amarillo. Longitud ajustable de patillas con sistema telescópico. Tipo de filtro: 5-4,1. Clase óptica: 2	595-G	6,11

07



Serie 3M™ Solus 1000 con recubrimiento Scotchgard™



Unas lentes empañadas pueden molestar y ser peligrosas. El recubrimiento anti-empañamiento 3M™ Scotchgard™ resiste el empañamiento más tiempo que el recubrimiento tradicional, incluso después de lavarse múltiples veces. Prueba las gafas 3M™ Solus™ Serie 1000 con recubrimiento anti-empañamiento 3M™ Scotchgard™ y vea claramente, durante más tiempo.

Las propiedades anti-empañamiento y anti-rayadura de las gafas Solus1000 cumplen con los requisitos de marcados K y N de EN166.

Disponibles kits con lentes incoloras en cada tipo de montura, que incluyen una banda y un inserto de espuma.

Color Ocular: Incoloro

También disponible en:

Solus™ 1101: Incoloro

Solus™ 1102: Gris

Solus™ 1103: Amarillo

Material Ocular: Policarbonato

Color marco: Verde/negro Azul/negro



Ref.	Código	Descripción	€/ u.
1015220	7100080184	Solus 1101 kit gafas negro/azul pc incolora, inserción de espuma, banda elástica, recubrimiento Scotchgard.	24,16
1015221	7100080258	Solus 1101 gafas negro/azul pc incolora, recubrimiento Scotchgard.	16,01
1015222	7100080185	Solus 1102 gafas negro/azul pc gris, recubrimiento Scotchgard.	16,47
1015223	7100080187	Solus 1103 gafas negro/azul pc amarillo, recubrimiento Scotchgard.	16,34
1015224	7100078881	Solus 1201 kit gafas negro/verde pc incolora, inserción de espuma, banda elástica, recubrimiento Scotchgard.	24,14
1015225	7100078882	Solus 1201 gafas negro/verde pc incolora, recubrimiento Scotchgard.	15,88
1015226	7100078883	Solus 1102 gafas negro/azul pc gris, recubrimiento Scotchgard.	16,51
1015227	7100080186	Solus 1103 gafas negro/azul pc amarillo, recubrimiento Scotchgard.	16,23
1015228	7100081293	Solus 1000 inserción de espuma para mejor ajuste y confort	5,59
1015229	7100081292	Solus 1000 banda de ajuste	4,90

Gafa de montura universal



Ref.	Código	Ocular	€/ u.
1002581	2188-GC	Gafa CARBON claro	8,70
1002582	2188-GCG	Gafa CARBON gris solar	10,62
1002585	2188-GD	Gafa DUAL claro	10,18
1002586	2188-GSC	Gafa SPY CITY claro	2,88
1002587	2188-GSPG	Gafa SPY PRO gris	3,39
1002588	2188-GSPE	Gafa SPY PRO espejo	4,10



Gafa de montura universal



Ref.	Código	Modelo	Descripción	€/ u.
1003170	2015569101	569-I	Material: Policarbonato. Protección lateral. Clase óptica: 1	3,47
1003171	2015569301	569-A	Material: Policarbonato amarillo. Protección lateral. Longitud ajustable patillas. Tipo de filtro: 2C-1,2. Clase óptica: 2	3,47
1003172	2015569201	569-G	Material: Policarbonato amarillo. Protección lateral. Longitud ajustable patillas. Tipo de filtro: 5-4,1. Clase óptica: 2	3,47

3M™ SecureFit™ 400



La serie Secure Fit 400 tiene un diseño único, estilo y un peso muy ligero – sólo pesan 19 gr. Suave recubrimiento antideslizante en la cara interna de la patilla para un mejor ajuste y confort. Puente nasal autoajustable. Disponibles diferentes variedades de lente, incoloras, gris, amarillo azul espejo o Indoor/Outdoor espejo. Excelente compatibilidad con las nuevas series de orejeras Peltor-X. Se ajusta a una amplia variedad de tamaños de cabeza lo que reduce la necesidad de tener en stock diferentes Talla de gafas.



Ref.	Código	Descripción	€/ u.
1015230	7100078989	SF401af Gafas pc-incolora AR y AE	9,69
1015231	7100078987	SF402af Gafas pc-gris AR y AE	10,18
1015232	7100078986	SF403AF Gafas pc-amarilla AR y AE	10,19
1015233	7100078880	SF408as Gafas pc-azul AR	11,62
1015234	7100078988	SF410AS Gafas pc-in&out AR	11,63

Serie 3M™ OX cubregafas



Cubregafas efectivos y cómodos que ofrecen un ajuste perfecto sobre cualquier tipo de gafas graduadas. Sin piezas metálicas (perfectas para electricistas). Patillas con longitud regulable 5 posiciones y extremos giratorios (OX2000). Los extremos de goma antideslizante proporcionan confort adicional.



Ref.	Código	Descripción	€/ u.
1015600	7000062166	OX1000 Cubregafas montura negra pc incolora patillas estándar	6,55
1015601	7000032519	OX2000 Cubregafas montura azul pc dx incolora patilla pivotante	10,99
1015602	7000062167	OX3000 Cubregafas montura azul pc dx incolora patilla recta	9,41

Gafa protección lateral



Ref.	Código	Descripción	Modelo	€/ u.
1003180	2015569100	Gafa de montura universal destinada a la protección frente a los riesgos de impactos de partículas de alta velocidad y baja energía	569-I	3,47
1003181	2015569201	Gafa de montura universal destinada a la protección frente a los riesgos de impactos de partículas de alta velocidad y baja energía	569-G	3,47
1003184	2015580301	Material: Policarbonato. Protección lateral. Tipo de filtro: 2-1,2. Clase óptica: 2	580-A	3,20
1003185	2015580601	Material: Policarbonato. Protección lateral. Tipo de filtro: 2-1,2. Clase óptica: 2	580-I	3,20

07



Serie 3M™ 2800



Los cubregafas 3M™ 2800 están diseñados para poder utilizarse sobre la mayoría de gafas graduadas con un mínimo de interferencia. Ofrecen una cobertura y un campo visual excelentes y un alto nivel de protección frente a impactos. Diferentes tonos de ocular. Tratamiento antirrayadura. Protección UV.

Ref.	Código	Descripción	Ocular	€ / u.
1002020	7000032493	2800 Cubregafas confort - incolora y AR	Incoloro	10,90
1002021	7000032494	2802 Cubregafas confort - amarilla y AR	Amarillo	10,90



Serie 3M™ 2840



Protección, comodidad y adaptabilidad. Con un estilo único, las gafas 2840 han sido diseñadas pensando en la conveniencia y comodidad del usuario. Las patillas son totalmente inclinables y ajustables en longitud para un ajuste óptimo. El interior suave de la patilla ofrece una mayor comodidad.

Ref.	Código	Descripción	Ocular	€ / u.
1002050	7000032459	2840 Gafas ultimate comfort pc- incolora AR y AE	Incoloro	13,65
1002052	7000032461	2842 Gafas ultimate comfort pc - amarilla AR y AE	Amarillo	14,12
1002055	7000061886	2846 Gafas ultimate comfort pc- naranja AR y AE	Naranja	15,83



3M™ Solus™ Safety Glasses - CCS Series



Las gafas de seguridad 3M™ Solus™ CCS SCCS01SGAF-GRN-F-EU son unas gafas de seguridad sin montura que cuentan con patillas de color verde lima y un sistema de control con cordón (CCS) para instalar tapones para los oídos con cordón. La lente de policarbonato transparente cuenta con recubrimiento antiempañante y antirrayaduras Scotchgard™ en ambos lados para mejorar la visión y la durabilidad. Vienen con una junta con inserto de espuma extraíble.

Ref.	Código	Ocular	€ / u.
21003010	7100216261	Incoloro + inserto de espuma	14,74
21003011	7100216507	Incoloro	9,96
21003012	7100216595	Gris	10,38
21003013	7100216621	I/O Gris	10,48



3M™ TORA CCS™



Diseñada para mantener los protectores auditivos unidos a la protección ocular, gracias al nuevo sistema de Control de Cordón. Incluye tratamiento antirrayadura y antiempañamiento.

Ref.	Código	Descripción	Ocular	€ / u.
1015800	7000043086	TORA CCS PC incolora AR y AE, patilla para cordón del protector auditivo	Incoloro	8,40



3M™ Serie Goggle Gear 500



3M™ Goggle Gear Serie 500 tiene un diseño de bajo perfil, banda ajustable y opción de utilizar un inserto graduado. Las gafas están disponibles con un recubrimiento anti-empañamiento 3M™ Scotchgard™ que resiste el empañamiento más tiempo que el recubrimiento tradicional. Color Ocular: Incoloro
Material Ocular: Policarbonato



Ref.	Código	Descripción	€/ u.
1015236	7100083064	GOOGLE gear 500 inserto para lentes graduadas.	13,00

3M™ Virtua AP™



Seguridad y diseño al servicio de su presupuesto. Diseño unisex con ocular de policarbonato incoloro o gris. Incluye tratamiento antirayadura. Muy ligera y envolvente, muy segura.



Ref.	Código	Descripción	€/ u.
1015850	7100006209	VIRTUA AP Gafas pc incolora AR	4,16
1015851	7100010682	VIRTUA AP Gafas pc gris AR	4,67

Gafa panorámica, serie 3M™ FAHRENHEIT



Diseñado específicamente para llevar con gafas graduadas, máscaras antipolvo o máscaras respiratorias de media cara. Tratamiento antiempañamiento y antirayadura. Disponible en policarbonato (en trabajos mecánicos) y acetato (aplicaciones químicas).



Ref.	Código	Descripción	€/ u.
1015900	7000062781	FAHRENHEIT Gafas ventilación indirecta pc incolora AR y AE	12,08
1015901	7000062782	FAHRENHEIT Gafas ventilación indirecta pc incolora ar	10,74
1015902	7000062783	FAHRENHEIT Gafas t-n-wear ventilación indirecta, acetato AR y AE	17,80
1015903	7000062784	FAHRENHEIT Gafas banda espuma ventilación indirecta pc AR y AE	15,58
1015904	7100010410	FAHRENHEIT Gafas estanca acetato incolora AR y AE	16,80
1015905	7000061926	Películas de poliéster para FAHRENHEIT x10	0,94
1015906	7000062786	FAHRENHEIT Gafas banda espuma estanca acetato incolora AR y AE para casco g3000	17,09

Gafa panorámica



Montura de vinilo flexible. Ocular en acetato antiempañante. Puede ser utilizada con gafas graduadas. Clase óptica 1.



Ref.	Código	Modelo	€/ u.
1000120	2014539100	539. Con ventilación	4,75
1000121	2014539300	539-C. Sin ventilación	4,75

07



Gafa de montura integral

Ref.	Código	Color	€/ u.
1002590	2188-GIX7A	Azul	6,46
8000220	2188-GIX7G	Gris	6,46
8000221	2188-GIX7N	Naranja	6,46



Gafa panorámica, serie 3M™ 2890



Montura integral. Resistencia a impactos. Protección UV. Resistencia al empañamiento y rayadura [según referencia]. Disponible en versión estanca y con ventilación indirecta. Protección frente a gases y vapores, gotas de líquido y partículas de polvo finas [según referencia]. Protección frente a metales fundidos (2890 y 2890S). Ocular en acetato (mayor resistencia química) y en policarbonato (mayor resistencia mecánica). Compatible con la mayoría de las gafas graduadas.



Ref.	Código	Descripción	Ocular	€/ u.
1002090	7000032481	2890A Gafas ventilación indirecta acetato incolora AE	Acetato ventilación indirecta	19,18
1002091	7000032483	2890SA Gafas estanca acetato incolora AE	Acetato estanca	18,97

Ref.	Código	Descripción	Ocular	€/ u.
1002092	7000061924	2890S Gafas estanca pc incolora AR y AE	Policarbonato estanca	16,51
1002093	7000032480	2890 Gafas ventilación indirecta pc incolora AR y AE, metales fundidos	Policarbonato ventilación indirecta	16,19

3M™ SecureFit™ 200



Sabiendo que la falta de comodidad y ajuste son las mayores barreras para el uso de gafas de protección, 3M presenta una revolucionaria gama de gafas de seguridad que se ajusta automáticamente al tamaño de cada cabeza, ofreciendo niveles de confort personal y seguridad de ajuste perceptiblemente mayores. Con un peso de 18 g., las ligeras gafas no tienen partes móviles. Simplemente se ajustan para adaptarse a una amplia gama de tamaños de cabeza mediante la tecnología exclusiva 3M de difusión de presión a lo largo de la patilla.



Ref.	Código	Descripción	€/ u.
1000136	7100112010	SF202AF Gafas PC-gris AR y AE	8,42
1000137	7100112008	SF203AF Gafas PC-amarilla AR y AC	8,39

Ref.	Código	Descripción	€/ u.
1000138	7100112180	SF201AS Gafas PC-incolora AR	6,61

Gafa panorámica



La montura es de material vinílico y su diseño permite su utilización con la mayoría de las gafas graduadas del propio usuario. El ocular de policarbonato ofrece una excelente protección frente a los riesgos mecánicos. La banda de sujeción es ajustable para adaptarse a la diferente morfología de los usuarios.



Ref.	Código	Color	€/ u.
21027002	20145194000	Incoloro NK	18,16
21027003	20145191000	Incoloro	13,28
21027004	20145193000	Humo	14,10
21027005	20145192000	Amarillo	14,10

3M™ SecureFit™ serie 600



3M™ SecureFit™ es la marca de gafas de protección que eligen los profesionales, y la nueva Serie 600 es aún mejor. Las gafas de protección 3M™ SecureFit™ Serie 600 combinan las mejores características de modelos ya existentes y añaden otras nuevas. Están diseñadas para ofrecer la máxima comodidad, ajuste y claridad, para mantenerse en su sitio y protegerte en todo momento. Gracias a un amplio abanico de opciones, existe una versión adecuada para cada situación: distintos colores de lente, recubrimiento antirrayaduras y antiempañante 3M™ Scotchgard™, tecnología de difusión de la presión (PDT) para una máxima seguridad y confort, inserto de espuma y mucho más.



Ref.	Código	Descripción	€ / u.
8002903	7100112717	SF601SGAF-EU, 3M™ SecureFit™ 600 Scotchgard™ Anti-empañamiento, ocular transparente	17,18
8002904	7100112716	SF602SGAF-EU, 3M™ SecureFit™ 600 Scotchgard™ Anti-empañamiento, ocular gris	17,86
8002905	7100112712	SF603SGAF-EU, 3M™ SecureFit™ 600 Scotchgard™ Anti-empañamiento, ocular ambar	17,69
8002909	7100112713	SF611AS-EU, 3M™ SecureFit™ 600 Anti-rayadura, ocular gris polarizado	65,40
8002912	7100112725	SF600FI-EU 3M™ SecureFit™ 600 Inserto de espuma	5,57

3M™ SecureFit™ Gafas de protección - 3700 Serie



La serie SecureFit 3700, dotada de tecnología Pressure Diffusion Temple (PDT) y patillas ajustables mediante ruleta, ofrece protección para usar con gafas graduadas con un ajuste personalizado.



Ref.	Código	Protección	€ / u.
21003017	7100217946	IR 1,7	24,14
21003018	7100218078	IR 3,0	24,51
21003019	7100218079	IR 5,0	24,78

3M™ Solus™ 2000, Gafas de seguridad para lectura



Ref.	Código	Descripción	€ / u.
21003020	7100218151	Patillas azules/grises, antiempañante/antirrayaduras, lente incolora correctora +2,5, S2025AF-BLU	16,65
21003021	7100218163	Patillas azules/grises, antiempañante/antirrayaduras, lente incolora correctora +2,0, S2020AF-BLU	16,69

Gafa para soldar



Ref.	Código	Modelo	Descripción	€ / u.
1002250	2011545106	545-A	Montura: Vinilo. Clase óptica: 1. Lente: 50 mm. Cristales redondos. Tonos: 4 a 6	11,52
1003191	2011620106	620	Montura: Tipo casco. Clase óptica: 1. Lente: 50 mm. Cristales redondos. Longitud ajustable. Tonos: 4 a 6	11,52

3M™ Gafa de seguridad para soldadura



Ref.	Código	Descripción	€ / u.
21003014	7100218150	3M™ Solus™ 2000, Gafas de seguridad, montura negra/verde, antirrayaduras + (K), lente gris IR 1.7, S2017ASP-BLK	18,17
21003015	7100218153	3M™ Solus™ 2000, Gafas de seguridad, montura negra/verde, antirrayaduras + (K), lente gris IR 3.0, S2030ASP-BLK	18,28
21003016	7100220423	3M™ Solus™ 2000, Gafas de seguridad, montura negra/verde, antirrayaduras + (K), lente gris IR 5.0, S2050ASP-BLK	18,62
1016060	7100010431	2895S Gafas estancas ocular tono 5 para soldadura	24,06
8002906	7100112721	SF617AS-EU, 3M™ SecureFit™ 600 Anti-rayadura, ocular soldadura tono 1,7	24,00
8002907	7100112724	SF630AS-EU, 3M™ SecureFit™ 600 Anti-rayadura, ocular soldadura tono 3	24,00
8002908	7100112715	SF650AS-EU, 3M™ SecureFit™ 600 Anti-rayadura, ocular soldadura tono 5	24,07
1016050	7000061936	2805 Cubregafas CONFORT - tono 5 y AR	18,77

Buzo algodón azulina



Ref.	Código	Color	Talla	€ / u.	Ref.	Código	Color	Talla	€ / u.
Buzo algodón 200 grs.					Buzo algodón Supertop 200 grs.				
1000140	388-B48		48		1000165	488-BSUPTOP48		48	
1000141	388-B50		50		1000166	488-BSUPTOP50		50	
1000142	388-B52		52		1000167	488-BSUPTOP52		52	
1000143	388-B54		54		1000168	488-BSUPTOP54		54	
1000144	388-B56		56		1000169	488-BSUPTOP56		56	
1000145	388-B58	Azulina	58	25,47	1000170	488-BSUPTOP58	Azulina	58	36,93
1000146	388-B60		60		1000171	488-BSUPTOP60		60	
1000147	388-B62		62		1000172	488-BSUPTOP62		62	
1000148	388-B64		64		1000173	488-BSUPTOP64		64	
1000149	388-B66		66		1000174	488-BSUPTOP66		66	
1000160	388-B68		68		1000175	488-BSUPTOP68		68	
1000161	388-B70		70						



388-B48

488-BSUPTOP48

07

Buzo 100% algodón



Dispone de dos bolsillos abiertos, uno lateral [cuchillero], uno trasero y uno superior con cierre de cremallera. Cierre frontal con cremallera y tapeta. Elástico en la parte trasera de la cintura. Puño elástico



Talla/Color			€ / u.
	Ref.	Código	
50	2401350	852BL/50	47,00
52	2401351	852BL/52	
54	2401352	852BL/54	
56	2401353	852BL/56	
58	2401354	852BL/58	
60	2401355	852BL/60	
62	2401356	852BL/62	
64	2401357	852BL/64	
66	2401358	852BL/66	

Pantalón tergal multibolsillos 200 grs.



388-P38



388-PAM 38



388-PB 38



388-PG 38



388-PM 38



388-PV 38

Talla/Color	Azulina.		Azul marino.		Blanco.		€ / u.
	Ref.	Código	Ref.	Código	Ref.	Código	
38	1000322	388-P38	1000335	388-PAM 38	1000348	388-PB 38	11,14
40	1000323	388-P40	1000336	388-PAM 40	1000349	388-PB 40	
42	1000324	388-P42	1000337	388-PAM 42	1000352	388-PB 42	
44	1000325	388-P44	1000338	388-PAM 44	1000353	388-PB 44	
46	1000326	388-P46	1000339	388-PAM 46	1000354	388-PB 46	
48	1000327	388-P48	1000340	388-PAM 48	1000355	388-PB 48	
50	1000328	388-P50	1000341	388-PAM 50	1000356	388-PB 50	
52	1000329	388-P52	1000342	388-PAM 52	1000357	388-PB 52	
54	1000330	388-P54	1000343	388-PAM 54	1000358	388-PB 54	
56	1000331	388-P56	1000344	388-PAM 56	1000359	388-PB 56	
58	1000332	388-P58	1000345	388-PAM 58	1000360	388-PB 58	
60	1000333	388-P60	1000346	388-PAM 60	1000361	388-PB 60	
62	1000334	388-P62	1000347	388-PAM 62	1000362	388-PB 62	

Talla/Color	Gris.		Beige.		Verde.		€ / u.
	Ref.	Código	Ref.	Código	Ref.	Código	
38	1000363	388-PG 38	1000376	388-PM 38	1000389	388-PV 38	11,14
40	1000364	388-PG 40	1000377	388-PM 40	1000390	388-PV 40	
42	1000365	388-PG 42	1000378	388-PM 42	1000391	388-PV 42	
44	1000366	388-PG 44	1000379	388-PM 44	1000392	388-PV 44	
46	1000367	388-PG 46	1000380	388-PM 46	1000393	388-PV 46	
48	1000368	388-PG 48	1000381	388-PM 48	1000394	388-PV 48	
50	1000369	388-PG 50	1000382	388-PM 50	1000395	388-PV 50	
52	1000370	388-PG 52	1000383	388-PM 52	1000396	388-PV 52	
54	1000371	388-PG 54	1000384	388-PM 54	1000397	388-PV 54	
56	1000372	388-PG 56	1000385	388-PM 56	1000398	388-PV 56	
58	1000373	388-PG 58	1000386	388-PM 58	1000399	388-PV 58	
60	1000374	388-PG 60	1000387	388-PM 60	1000410	388-PV 60	
62	1000375	388-PG 62	1000388	388-PM 62	1000411	388-PV 62	

Pantalón algodón 200 grs.



Talla/Color	Azulina.		€/ u.
	Ref.	Código	
38	1000412	388-PE38	13,44
40	1000413	388-PE40	
42	1000414	388-PE42	
44	1000415	388-PE44	
46	1000416	388-PE46	
48	1000417	388-PE48	
50	1000418	388-PE50	
52	1000419	388-PE52	
54	1000420	388-PE54	
56	1000421	388-PE56	
58	1000422	388-PE58	
60	1000423	388-PE60	
62	1000424	388-PE62	



Pantalón básico



Pantalón básico corte slim fit. Cierre central con cremallera y botón. Cinturilla elástica para mayor comodidad y ajuste. Cintura con presillas antidesgarro. Doble costura exterior de seguridad. 2 bolsillos delanteros tipo jeans. 2 bolsillos laterales de parche con tapeta y velcro. 2 bolsillos traseros de parche.



ROLL BLACK

ROLL GREY

ROLL NAVY

Talla/Color	Negro.		Gris.		Azul navy.		€/ u.
	Ref.	Código	Ref.	Código	Ref.	Código	
XS	2401090	ROLL BLACK XS	2401099	ROLL GREY XS	2401108	ROLL NAVY XS	16,01
S	2401088	ROLL BLACK S	2401097	ROLL GREY S	2401106	ROLL NAVY S	
M	2401087	ROLL BLACK M	2401096	ROLL GREY M	2401105	ROLL NAVY M	
L	2401086	ROLL BLACK L	2401095	ROLL GREY L	2401104	ROLL NAVY L	
XL	2401089	ROLL BLACK XL	2401098	ROLL GREY XL	2401107	ROLL NAVY XL	
2XL	2401082	ROLL BLACK 2XL	2401091	ROLL GREY 2XL	2401100	ROLL NAVY 2XL	
3XL	2401083	ROLL BLACK 3XL	2401092	ROLL GREY 3XL	2401101	ROLL NAVY 3XL	
4XL	2401084	ROLL BLACK 4XL	2401093	ROLL GREY 4XL	2401102	ROLL NAVY 4XL	
5XL	2401085	ROLL BLACK 5XL	2401094	ROLL GREY 5XL	2401103	ROLL NAVY 5XL	

Pantalón algodón supertop 270 grs.



488-PASUPTOP



488-PNSUPTOP



488-PSUPTOP

Talla/Color	Azulina.		Azul marino.		Negro.		€/ u.
	Ref.	Código	Ref.	Código	Ref.	Código	
38	1000464	488-PSUPTOP38	1000425	488-PASUPTOP38	1000438	488-PNSUPTOP 38	23,04
40	1000465	488-PSUPTOP40	1000426	488-PASUPTOP40	1000439	488-PNSUPTOP 40	
42	1000466	488-PSUPTOP42	1000427	488-PASUPTOP42	1000440	488-PNSUPTOP 42	
44	1000467	488-PSUPTOP44	1000428	488-PASUPTOP44	1000441	488-PNSUPTOP 44	
46	1000468	488-PSUPTOP46	1000429	488-PASUPTOP46	1000442	488-PNSUPTOP 46	
48	1000469	488-PSUPTOP48	1000430	488-PASUPTOP48	1000443	488-PNSUPTOP 48	
50	1000470	488-PSUPTOP50	1000431	488-PASUPTOP50	1000444	488-PNSUPTOP 50	
52	1000471	488-PSUPTOP52	1000432	488-PASUPTOP52	1000445	488-PNSUPTOP 52	
54	1000472	488-PSUPTOP54	1000433	488-PASUPTOP54	1000446	488-PNSUPTOP 54	
56	1000473	488-PSUPTOP56	1000434	488-PASUPTOP56	1000447	488-PNSUPTOP 56	
58	1000474	488-PSUPTOP58	1000435	488-PASUPTOP58	1000448	488-PNSUPTOP 58	
60	1000475	488-PSUPTOP60	1000436	488-PASUPTOP60	1000449	488-PNSUPTOP 60	
62	1000476	488-PSUPTOP62	1000437	488-PASUPTOP62	1000450	488-PNSUPTOP 62	



Pantalón algodón stretch multibolsillos



103012S 0 S



103012S 61 S



103012S 8 S

Talla/Color	Negro.		Azul navy.		Gris.		€ / u.
	Ref.	Código	Ref.	Código	Ref.	Código	
S	8003657	103012S 0 S	8003663	103012S 61 S	8003669	103012S 8 S	39,12
M	8003656	103012S 0 M	8003662	103012S 61 M	8003668	103012S 8 M	
L	8003655	103012S 0 L	8003661	103012S 61 L	8003667	103012S 8 L	
XL	8003658	103012S 0 XL	8003664	103012S 61 XL	8003670	103012S 8 XL	
XXL	8003659	103012S 0 XXL	8003665	103012S 61 XXL	8003671	103012S 8 XXL	
3XL	8003660	103012S 0 3XL	8003666	103012S 61 3XL	8003672	103012S 8 3XL	

Pantalón algodón stretch multibolsillos



103004 1/12 34



103004 1/16 34



103004 1/25 34



103004 61/5 34

Talla/Color	Azul marino/rojo.		Azul marino/naranja.		Azul marino/verde lima.		Azul navy/celeste.		€ / u.
	Ref.	Código	Ref.	Código	Ref.	Código	Ref.	Código	
34	8003729	103004 1/12 34	8003743	103004 1/16 34	8003757	103004 1/25 34	8003771	103004 61/5 34	18,37
36	8003730	103004 1/12 36	8003744	103004 1/16 36	8003758	103004 1/25 36	8003772	103004 61/5 36	
38	8003731	103004 1/12 38	8003745	103004 1/16 38	8003759	103004 1/25 38	8003773	103004 61/5 38	
40	8003732	103004 1/12 40	8003746	103004 1/16 40	8003760	103004 1/25 40	8003774	103004 61/5 40	
42	8003733	103004 1/12 42	8003747	103004 1/16 42	8003761	103004 1/25 42	8003775	103004 61/5 42	
44	8003734	103004 1/12 44	8003748	103004 1/16 44	8003762	103004 1/25 44	8003776	103004 61/5 44	
46	8003735	103004 1/12 46	8003749	103004 1/16 46	8003763	103004 1/25 46	8003777	103004 61/5 46	
48	8003736	103004 1/12 48	8003750	103004 1/16 48	8003764	103004 1/25 48	8003778	103004 61/5 48	
50	8003737	103004 1/12 50	8003751	103004 1/16 50	8003765	103004 1/25 50	8003779	103004 61/5 50	
52	8003738	103004 1/12 52	8003752	103004 1/16 52	8003766	103004 1/25 52	8003780	103004 61/5 52	
54	8003739	103004 1/12 54	8003753	103004 1/16 54	8003767	103004 1/25 54	8003781	103004 61/5 54	
56	8003740	103004 1/12 56	8003754	103004 1/16 56	8003768	103004 1/25 56	8003782	103004 61/5 56	
58	8003741	103004 1/12 58	8003755	103004 1/16 58	8003769	103004 1/25 58	8003783	103004 61/5 58	
60	8003742	103004 1/12 60	8003756	103004 1/16 60	8003770	103004 1/25 60	8003784	103004 61/5 60	

07

Pantalón algodón stretch multibolsillos



103004 8/16 34



103004 8/5 34



103004 8/12 34



103004 8/25 34



103004 0/5 34



103004 0/25 34



103004 0/16 34



103004 0/12 34

Talla/Color	Gris/naranja.		Gris/celeste.		Gris/rojo.		Gris/verde lima.		€ / u.
	Ref.	Código	Ref.	Código	Ref.	Código	Ref.	Código	
34	8003799	103004 8/16 34	8003827	103004 8/5 34	8003785	103004 8/12 34	8003813	103004 8/25 34	18,37
36	8003800	103004 8/16 36	8003828	103004 8/5 36	8003786	103004 8/12 36	8003814	103004 8/25 36	
38	8003801	103004 8/16 38	8003829	103004 8/5 38	8003787	103004 8/12 38	8003815	103004 8/25 38	
40	8003802	103004 8/16 40	8003830	103004 8/5 40	8003788	103004 8/12 40	8003816	103004 8/25 40	
42	8003803	103004 8/16 42	8003831	103004 8/5 42	8003789	103004 8/12 42	8003817	103004 8/25 42	
44	8003804	103004 8/16 44	8003832	103004 8/5 44	8003790	103004 8/12 44	8003818	103004 8/25 44	
46	8003805	103004 8/16 46	8003833	103004 8/5 46	8003791	103004 8/12 46	8003819	103004 8/25 46	
48	8003806	103004 8/16 48	8003834	103004 8/5 48	8003792	103004 8/12 48	8003820	103004 8/25 48	
50	8003807	103004 8/16 50	8003835	103004 8/5 50	8003793	103004 8/12 50	8003821	103004 8/25 50	
52	8003808	103004 8/16 52	8003836	103004 8/5 52	8003794	103004 8/12 52	8003822	103004 8/25 52	
54	8003809	103004 8/16 54	8003837	103004 8/5 54	8003795	103004 8/12 54	8003823	103004 8/25 54	
56	8003810	103004 8/16 56	8003838	103004 8/5 56	8003796	103004 8/12 56	8003824	103004 8/25 56	
58	8003811	103004 8/16 58	8003839	103004 8/5 58	8003797	103004 8/12 58	8003825	103004 8/25 58	
60	8003812	103004 8/16 60	8003840	103004 8/5 60	8003798	103004 8/12 60	8003826	103004 8/25 60	

Talla/Color	Negro/verde lima.		Negro/celeste.		Negro/rojo.		Negro/naranja.		€ / u.
	Ref.	Código	Ref.	Código	Ref.	Código	Ref.	Código	
34	8003701	103004 0/25 34	8003715	103004 0/5 34	8003673	103004 0/12 34	8003687	103004 0/16 34	18,37
36	8003702	103004 0/25 36	8003716	103004 0/5 36	8003674	103004 0/12 36	8003688	103004 0/16 36	
38	8003703	103004 0/25 38	8003717	103004 0/5 38	8003675	103004 0/12 38	8003689	103004 0/16 38	
40	8003704	103004 0/25 40	8003718	103004 0/5 40	8003676	103004 0/12 40	8003690	103004 0/16 40	
42	8003705	103004 0/25 42	8003719	103004 0/5 42	8003677	103004 0/12 42	8003691	103004 0/16 42	
44	8003706	103004 0/25 44	8003720	103004 0/5 44	8003678	103004 0/12 44	8003692	103004 0/16 44	
46	8003707	103004 0/25 46	8003721	103004 0/5 46	8003679	103004 0/12 46	8003693	103004 0/16 46	
48	8003708	103004 0/25 48	8003722	103004 0/5 48	8003680	103004 0/12 48	8003694	103004 0/16 48	
50	8003709	103004 0/25 50	8003723	103004 0/5 50	8003681	103004 0/12 50	8003695	103004 0/16 50	
52	8003710	103004 0/25 52	8003724	103004 0/5 52	8003682	103004 0/12 52	8003696	103004 0/16 52	
54	8003711	103004 0/25 54	8003725	103004 0/5 54	8003683	103004 0/12 54	8003697	103004 0/16 54	
56	8003712	103004 0/25 56	8003726	103004 0/5 56	8003684	103004 0/12 56	8003698	103004 0/16 56	
58	8003713	103004 0/25 58	8003727	103004 0/5 58	8003685	103004 0/12 58	8003699	103004 0/16 58	
60	8003714	103004 0/25 60	8003728	103004 0/5 60	8003686	103004 0/12 60	8003700	103004 0/16 60	

07

Pantalón multibolsillos de poliester/algodón tejido 240 grs.



Pantalón multibolsillos bicolor. Dispone de dos bolsillos frontales abiertos, dos traseros con cierre velcro y tapeta y dos laterales. Cierre de cremallera y botón. Ajuste en cintura con elásticos, dispone de apertura con velcro para rodilleras.

Talla/Color	Azul marino/azulina.		€ / u.	Azulina/gris.		€ / u.
	Ref.	Código		Ref.	Código	
XS	1000871	952/XS	48,50	1000829	951/XS	49,48
S	1000868	952/S		1000826	951/S	
M	1000869	952/M		1000827	951/M	
L	1000870	952/L		1000828	951/L	
XL	1000872	952/XL		1000830	951/XL	
XXL	1000873	952/XXL		1000831	951/XXL	



952/XS



951/XS

Pantalón vaquero



Modernos vaqueros en algodón elástico, con tratamiento stone washed. Bolsillo lateral para móvil y bolsillo trasero. Bragueta con botones. Suministrado en caja. Composición: algodón elastizado.

Talla/Color	Azul.		€ / u.
	Ref.	Código	
XS	2401109	8025B-040-XS	39,00
S	2401110	8025B-040-S	
M	2401111	8025B-040-M	
L	2401112	8025B-040-L	
XL	2401113	8025B-040-XL	
XXL	2401114	8025B-040-XXL	
3XL	2401115	8025B-040-3XL	



Pantalón tejido vaquero STRETCH



Talla/Color	Azul marino.		€ / u.
	Ref.	Código	
38-40	1002634	588-PV 3840	34,94
42-44	1002635	588-PV 4244	
46-48	1002636	588-PV 4648	
50-52	1002637	588-PV 5052	
54-56	1002638	588-PV 5456	
58-60	1002639	588-PV 5860	
62-64	1002640	588-PV 6264	



Pantalón serie PRO "CANVAS Line" tergal



588-PRN 3840

588-PANE 3840

588-PNEG 3840

588-PN 3840

588-PBG 3840

588-PAZA 3840

Talla/Color	Rojo/negro.		Azul.		Gris/negro.		Negro.		Blanco/gris.		Azul.		€ / u.
	Ref.	Código	Ref.	Código	Ref.	Código	Ref.	Código	Ref.	Código	Ref.	Código	
38-40	8000508	588-PRN 3840	8000515	588-PANE 3840	8000522	588-PNEG 3840	8000529	588-PN 3840	8000536	588-PBG 3840	8000543	588-PAZA 3840	32,64
42-44	8000509	588-PRN 4244	8000516	588-PANE 4244	8000523	588-PNEG 4244	8000530	588-PN 4244	8000537	588-PBG 4244	8000544	588-PAZA 4244	
46-48	8000510	588-PRN 4648	8000517	588-PANE 4648	8000524	588-PNEG 4648	8000531	588-PN 4648	8000538	588-PBG 4648	8000545	588-PAZA 4648	
50-52	8000511	588-PRN 5052	8000518	588-PANE 5052	8000525	588-PNEG 5052	8000532	588-PN 5052	8000539	588-PBG 5052	8000546	588-PAZA 5052	
54-56	8000512	588-PRN 5456	8000519	588-PANE 5456	8000526	588-PNEG 5456	8000533	588-PN 5456	8000540	588-PBG 5456	8000547	588-PAZA 5456	
58-60	8000513	588-PRN 5860	8000520	588-PANE 5860	8000527	588-PNEG 5860	8000534	588-PN 5860	8000541	588-PBG 5860	8000548	588-PAZA 5860	
62-64	8000514	588-PRN 6264	8000521	588-PANE 6264	8000528	588-PNEG 6264	8000535	588-PN 6264	8000542	588-PBG 6264	8000549	588-PAZA 6264	

Pantalón canvas multibolsillos



Talla/Color	Negro.		Azul navy.		Gris claro.		Beige arena/negro.		Azul navy/negro.		Gris/negro.		€ / u.
	Ref.	Código	Ref.	Código	Ref.	Código	Ref.	Código	Ref.	Código	Ref.	Código	
S	8003621	103011 0 S	8003627	103011 61 S	8003633	103011 8 S	8003639	103011B 46/0 S	8003645	103011B 61/0 S	8003651	103011B 8/0 S	40,58
M	8003620	103011 0 M	8003626	103011 61 M	8003632	103011 8 M	8003638	103011B 46/0 M	8003644	103011B 61/0 M	8003650	103011B 8/0 M	
L	8003619	103011 0 L	8003625	103011 61 L	8003631	103011 8 L	8003637	103011B 46/0 L	8003643	103011B 61/0 L	8003649	103011B 8/0 L	
XL	8003622	103011 0 XL	8003628	103011 61 XL	8003634	103011 8 XL	8003640	103011B 46/0 XL	8003646	103011B 61/0 XL	8003652	103011B 8/0 XL	
XXL	8003623	103011 0 XXL	8003629	103011 61 XXL	8003635	103011 8 XXL	8003641	103011B 46/0 XXL	8003647	103011B 61/0 XXL	8003653	103011B 8/0 XXL	
3XL	8003624	103011 0 3XL	8003630	103011 61 3XL	8003636	103011 8 3XL	8003642	103011B 46/0 3XL	8003648	103011B 61/0 3XL	8003654	103011B 8/0 3XL	

Pantalón canvas stretch



Talla/Color	Beige arena/negro.		Azul navy/negro.		Gris/negro.		€ / u.
	Ref.	Código	Ref.	Código	Ref.	Código	
S	20018777	103019S 46/0 S	20018783	103019S 61/0 S	20018789	103019S 8/0S	43,92
M	20018776	103019S 46/0 M	20018782	103019S 61/0 M	20018788	103019S 8/0M	
L	20018775	103019S 46/0 L	20018781	103019S 61/0 L	20018787	103019S 8/0L	
XL	20018778	103019S 46/0 XL	20018784	103019S 61/0 XL	20018790	103019S 8/0XL	
XXL	20018779	103019S 46/0 XXL	20018785	103019S 61/0 XXL	20018791	103019S 8/0XXL	
3XL	20018780	103019S 46/0 3XL	20018786	103019S 61/0 3XL	20018792	103019S 8/03XL	

Pantalón multibolsillos de algodón/poliéster y elastano



Pantalón multibolsillos elástico en la cintura, bolsillos frontales y traseros con refuerzo y cierre velcro, apertura para rodilleras, cierre de cremallera y botón, refuerzo extra en la parte trasera [zona de mayor desgaste].



Talla/Color	Gris/negro.		Azul/negro.		€ / u.
	Ref.	Código	Ref.	Código	
XS	8001272	171/XS	8001279	181/XS	75,21
S	8001273	171/S	8001280	181/S	
M	8001274	171/M	8001281	181/M	
L	8001275	171/L	8001282	181/L	
XL	8001276	171/XL	8001283	181/XL	
XXL	8001277	171/XXL	8001284	181/XXL	
3XL	8001278	171/3XL	8001285	181/3XL	



Pantalon stretch con cintas



103014S 0 34 103014S 61 34 103014S 8 34

Talla/Color	Negro.		Azul navy.		Gris.		€ / u.
	Ref.	Código	Ref.	Código	Ref.	Código	
34	8003859	103014S 0 34	8003873	103014S 61 34	8003887	103014S 8 34	31,86
36	8003860	103014S 0 36	8003874	103014S 61 36	8003888	103014S 8 36	
38	8003861	103014S 0 38	8003875	103014S 61 38	8003889	103014S 8 38	
40	8003862	103014S 0 40	8003876	103014S 61 40	8003890	103014S 8 40	
42	8003863	103014S 0 42	8003877	103014S 61 42	8003891	103014S 8 42	
44	8003864	103014S 0 44	8003878	103014S 61 44	8003892	103014S 8 44	
46	8003865	103014S 0 46	8003879	103014S 61 46	8003893	103014S 8 46	
48	8003866	103014S 0 48	8003880	103014S 61 48	8003894	103014S 8 48	
50	8003867	103014S 0 50	8003881	103014S 61 50	8003895	103014S 8 50	
52	8003868	103014S 0 52	8003882	103014S 61 52	8003896	103014S 8 52	
54	8003869	103014S 0 54	8003883	103014S 61 54	8003897	103014S 8 54	
56	8003870	103014S 0 56	8003884	103014S 61 56	8003898	103014S 8 56	
58	8003871	103014S 0 58	8003885	103014S 61 58	8003899	103014S 8 58	
60	8003872	103014S 0 60	8003886	103014S 61 60	8003900	103014S 8 60	

Pantalón stretch multibolsillos



103022S46/0 S 103022S61/0 S 103022S8/0 S

Talla/Color	Beige arena/negro.		Azul navy/negro.		Gris/Negro.		€ / u.
	Ref.	Código	Ref.	Código	Ref.	Código	
S	20018879	103022S46/0 S	20018885	103022S61/0 S	20018891	103022S8/0 S	44,20
M	20018878	103022S46/0 M	20018884	103022S61/0 M	20018890	103022S8/0 M	
L	20018877	103022S46/0 L	20018883	103022S61/0 L	20018889	103022S8/0 L	
XL	20018880	103022S46/0 XL	20018886	103022S61/0 XL	20018892	103022S8/0 XL	
XXL	20018881	103022S46/0 XXL	20018887	103022S61/0 XXL	20018893	103022S8/0 XXL	
3XL	20018882	103022S46/0 3XL	20018888	103022S61/0 3XL	20018894	103022S8/0 3XL	

07



Pantalón multibolsillos de algodón/poliester y elastano de 200 grs.



Elástico lateral en la cintura, bolsillos abiertos frontales y traseros con cierre velcro, bolsillos laterales para guardar herramientas, cierre frontal de cremallera y botón, refuerzo extra en la parte trasera (zona de mayor desgaste).



121/XS

131/XS

Talla/Color	Azul marino.		Verde oliva.		€ / u.
	Ref.	Código	Ref.	Código	
XS	8001335	121/XS	8001342	131/XS	55,89
S	8001336	121/S	8001343	131/S	
M	8001337	121/M	8001344	131/M	
L			8001345	131/L	
XL			8001346	131/XL	
XXL			8001347	131/XXL	
3XL			8001348	131/3XL	

Pantalón multibolsillos 94% poliéster/6% elastano de entretiempo



Confeccionado con tejido muy ligero ideal para entretiempo o los meses de más calor. Tejido transpirable que ayuda a expulsar la sudoración y elástico que hace que la prenda sea muy flexible. Cierre frontal con cremallera y botón. Tiras reflectantes en las rodillas para mayor visibilidad. Dos bolsillos delanteros y uno trasero con cierre de cremallera. Elásticos en la cintura que hace que la prenda se adapte fácilmente.



Talla/Color	Azul marino.		€ / u.
	Ref.	Código	
L	8001338	121/L	55,89
XL	8001339	121/XL	
XXL	8001340	121/XXL	
3XL	8001341	121/3XL	

Pantalón largo Flex Light multibolsillos 57% algodón, 40% poliéster y 3% elastano de 200 grs./m²



Elástico lateral en la cintura, bolsillos abiertos frontales y traseros con cierre velcro, bolsillos laterales para guardar herramientas, cierre frontal de cremallera y botón, refuerzo extra en la parte trasera (zona de mayor desgaste).



Talla/Color	Negro.		€ / u.
	Ref.	Código	
XS	21060183	111/XS	55,89
S	21060184	111/S	
M	21060185	111/M	
L	21060186	111/L	
XL	21060187	111/XL	
XXL	21060188	111/XXL	
3XL	21060189	111/3XL	

Pantalón largo multibolsillos de poliéster/algodón



Elásticos en cintura. Cierre de cremallera y botón. Apertura para rodilleras

Talla/Color	Gris/naranja/negro.		€ / u.
	Ref.	Código	
XS	1016215	961/XS	57,58
S	1016216	961/S	
M	1016217	961/M	
L	1016218	961/L	
XL	1016219	961/XL	
XXL	1016220	961/XXL	
3XL	1016221	961/3XL	



Pantalón elástico



Pantalón elástico con elástico en cintura, bolsillo lateral y porta metro, porta rodilleras en tejido stretch. Suministrado en caja
Composición: 97% algodón, 3% spandex. 260 g/m2.



8731B-040-XS



8731B-080-XS

Talla/Color	Beige.		Azul.		Gris.		€ / u.
	Ref.	Código	Ref.	Código	Ref.	Código	
XS	2401116	8731B-025-XS	2401123	8731B-040-XS	2401130	8731B-080-XS	51,50
S	2401117	8731B-025-S	2401124	8731B-040-S	2401131	8731B-080-S	
M	2401118	8731B-025-M	2401125	8731B-040-M	2401132	8731B-080-M	
L	2401119	8731B-025-L	2401126	8731B-040-L	2401133	8731B-080-L	
XL	2401120	8731B-025-XL	2401127	8731B-040-XL	2401134	8731B-080-XL	
XXL	2401121	8731B-025-XXL	2401128	8731B-040-XXL	2401135	8731B-080-XXL	
3XL	2401122	8731B-025-3XL	2401129	8731B-040-3XL	2401136	8731B-080-3XL	

Pantalón técnico con inserciones en tejido antiabrasión y reflectantes



Pantalón técnico con inserciones en tejido antiabrasión y reflectantes. Posibilidad de regulación en longitud y cintura. El tejido elástico permite tanto la comodidad como una imagen propia de los mejores pantalones del mundo deportivo. Dispone de 9 bolsillos, entre los cuales uno porta móvil y otro porta metro. Triples costuras y un tejido particularmente resistente garantizan una alta resistencia durante los trabajos más duros. Suministrado en caja.
Composición: 65% poliéster, 32% algodón, 3% spandex. 260 g/m2.



Talla/Color	Azul.		Gris claro.		Gris.		Fango.		€ / u.
	Ref.	Código	Ref.	Código	Ref.	Código	Ref.	Código	
XS			2401143	8830B-078-XS	2401150	8830B-080-XS	2401157	8830B-200-XS	59,70
S	2401137	8830B-040-S	2401144	8830B-078-S	2401151	8830B-080-S	2401158	8830B-200-S	
M	2401138	8830B-040-M	2401145	8830B-078-M	2401152	8830B-080-M	2401159	8830B-200-M	
L	2401139	8830B-040-L	2401146	8830B-078-L	2401153	8830B-080-L	2401160	8830B-200-L	
XL	2401140	8830B-040-XL	2401147	8830B-078-XL	2401154	8830B-080-XL	2401161	8830B-200-XL	
XXL	2401141	8830B-040-XXL	2401148	8830B-078-XXL	2401155	8830B-080-XXL	2401162	8830B-200-XXL	
3XL	2401142	8830B-040-3XL	2401149	8830B-078-3XL	2401156	8830B-080-3XL	2401163	8830B-200-3XL	

Talla/Color	Gris.		€ / u.
	Ref.	Código	
S	2401164	8837B-080-S	59,50
M	2401165	8837B-080-M	
L	2401166	8837B-080-L	
XL	2401167	8837B-080-XL	
XXL	2401168	8837B-080-XXL	
3XL	2401169	8837B-080-3XL	

Talla/Color	Azul marino-Amarillo flúor.		€ / u.
	Ref.	Código	
XS	2401212	8038-052-XS	32,06
S	2401213	8038-052-S	
M	2401214	8038-052-M	
L	2401215	8038-052-L	
XL	2401216	8038-052-XL	
XXL	2401217	8038-052-XXL	
3XL	2401218	8038-052-3XL	

Talla/Color	Verde.		Beige.		Azul.		Blanco.		Negro.		Gris.		€ / u.
	Ref.	Código	Ref.	Código	Ref.	Código	Ref.	Código	Ref.	Código	Ref.	Código	
XS	2401170	8038-020-XS	2401177	8038-025-XS	2401184	8038-040-XS	2401191	8038-050-XS	2401198	8038-060-XS	2401205	8038-080-XS	27,30
S	2401171	8038-020-S	2401178	8038-025-S	2401185	8038-040-S	2401192	8038-050-S	2401199	8038-060-S	2401206	8038-080-S	
M	2401172	8038-020-M	2401179	8038-025-M	2401186	8038-040-M	2401193	8038-050-M	2401200	8038-060-M	2401207	8038-080-M	
L	2401173	8038-020-L	2401180	8038-025-L	2401187	8038-040-L	2401194	8038-050-L	2401201	8038-060-L	2401208	8038-080-L	
XL	2401174	8038-020-XL	2401181	8038-025-XL	2401188	8038-040-XL	2401195	8038-050-XL	2401202	8038-060-XL	2401209	8038-080-XL	
XXL	2401175	8038-020-XXL	2401182	8038-025-XXL	2401189	8038-040-XXL	2401196	8038-050-XXL	2401203	8038-060-XXL	2401210	8038-080-XXL	
3XL	2401176	8038-020-3XL	2401183	8038-025-3XL	2401190	8038-040-3XL	2401197	8038-050-3XL	2401204	8038-060-3XL	2401211	8038-080-3XL	

07

Pantalón técnico con inserciones en tejido antiabrasión y reflectantes



Pantalón stretch de moderno diseño con la incorporación de detalles reflectantes. Su tejido resistente, ligero y elástico lo convierten en una prenda ideal para aquellos trabajos que requieren de mayor movilidad. Incorpora dos bolsillos frontales, dos bolsillos traseros, un bolsillo lateral y bolsillo porta metro. Suministrado en caja. Composición: 97% algodón, 3% spandex. 260 g/m2.



Talla/Color	Azul.		Gris claro.		Gris antracita.		€ / u.
	Ref.	Código	Ref.	Código	Ref.	Código	
XS	2401219	8036B-040-XS	2401226	8036B-078-XS	2401233	8036B-081-XS	29,90
S	2401220	8036B-040-S	2401227	8036B-078-S	2401234	8036B-081-S	
M	2401221	8036B-040-M	2401228	8036B-078-M	2401235	8036B-081-M	
L	2401222	8036B-040-L	2401229	8036B-078-L	2401236	8036B-081-L	
XL	2401223	8036B-040-XL	2401230	8036B-078-XL	2401237	8036B-081-XL	
XXL	2401224	8036B-040-XXL	2401231	8036B-078-XXL	2401238	8036B-081-XXL	
3XL	2401225	8036B-040-3XL	2401232	8036B-078-3XL	2401239	8036B-081-3XL	

Talla/Color	Beige.		Azul.		Blanco.		Gris.		€ / u.
	Ref.	Código	Ref.	Código	Ref.	Código	Ref.	Código	
XS	2401240	8730B-025-XS					2401258	8730B-080-XS	53,30
S	2401241	8730B-025-S	2401247	8730B-040-S	2401252	8730B-050-S	2401259	8730B-080-S	
M	2401242	8730B-025-M	2401248	8730B-040-M	2401253	8730B-050-M	2401260	8730B-080-M	
L	2401243	8730B-025-L	2401249	8730B-040-L	2401254	8730B-050-L	2401261	8730B-080-L	
XL	2401244	8730B-025-XL	2401250	8730B-040-XL	2401255	8730B-050-XL	2401262	8730B-080-XL	
XXL	2401245	8730B-025-XXL	2401251	8730B-040-XXL	2401256	8730B-050-XXL	2401263	8730B-080-XXL	
3XL	2401246	8730B-025-3XL			2401257	8730B-050-3XL	2401264	8730B-080-3XL	

Bermuda bicolor multibolsillos



103007 1/12 34 103007 1/16 34 103007 1/25 34 103007 61/5 34

Talla/Color	Azul marino/rojo.			Azul marino/naranja.			Azul marino/verde lima.			Azul navy/celeste.			€ / u.
	Ref.	Código		Ref.	Código		Ref.	Código		Ref.	Código		
34	8004399	103007	1/12 34	8004413	103007	1/16 34	8004427	103007	1/25 34	8004441	103007	61/5 34	16,22
36	8004400	103007	1/12 36	8004414	103007	1/16 36	8004428	103007	1/25 36	8004442	103007	61/5 36	
38	8004401	103007	1/12 38	8004415	103007	1/16 38	8004429	103007	1/25 38	8004443	103007	61/5 38	
40	8004402	103007	1/12 40	8004416	103007	1/16 40	8004430	103007	1/25 40	8004444	103007	61/5 40	
42	8004403	103007	1/12 42	8004417	103007	1/16 42	8004431	103007	1/25 42	8004445	103007	61/5 42	
44	8004404	103007	1/12 44	8004418	103007	1/16 44	8004432	103007	1/25 44	8004446	103007	61/5 44	
46	8004405	103007	1/12 46	8004419	103007	1/16 46	8004433	103007	1/25 46	8004447	103007	61/5 46	
48	8004406	103007	1/12 48	8004420	103007	1/16 48	8004434	103007	1/25 48	8004448	103007	61/5 48	
50	8004407	103007	1/12 50	8004421	103007	1/16 50	8004435	103007	1/25 50	8004449	103007	61/5 50	
52	8004408	103007	1/12 52	8004422	103007	1/16 52	8004436	103007	1/25 52	8004450	103007	61/5 52	
54	8004409	103007	1/12 54	8004423	103007	1/16 54	8004437	103007	1/25 54	8004451	103007	61/5 54	
56	8004410	103007	1/12 56	8004424	103007	1/16 56	8004438	103007	1/25 56	8004452	103007	61/5 56	
58	8004411	103007	1/12 58	8004425	103007	1/16 58	8004439	103007	1/25 58	8004453	103007	61/5 58	
60	8004412	103007	1/12 60	8004426	103007	1/16 60	8004440	103007	1/25 60	8004454	103007	61/5 60	

Bermuda bicolor multibolsillos



Talla/Color	Gris/naranja.		Gris/celeste.		Gris/verde lima.		Gris/rojo.		€ / u.
	Ref.	Código	Ref.	Código	Ref.	Código	Ref.	Código	
34	8004469	103007 8/16 34	8004497	103007 8/5 34	8004483	103007 8/25 34	8004455	103007 8/12 34	
36	8004470	103007 8/16 36	8004498	103007 8/5 36	8004484	103007 8/25 36	8004456	103007 8/12 36	
38	8004471	103007 8/16 38	8004499	103007 8/5 38	8004485	103007 8/25 38	8004457	103007 8/12 38	
40	8004472	103007 8/16 40	8004500	103007 8/5 40	8004486	103007 8/25 40	8004458	103007 8/12 40	
42	8004473	103007 8/16 42	8004501	103007 8/5 42	8004487	103007 8/25 42	8004459	103007 8/12 42	
44	8004474	103007 8/16 44	8004502	103007 8/5 44	8004488	103007 8/25 44	8004460	103007 8/12 44	
46	8004475	103007 8/16 46	8004503	103007 8/5 46	8004489	103007 8/25 46	8004461	103007 8/12 46	
48	8004476	103007 8/16 48	8004504	103007 8/5 48	8004490	103007 8/25 48	8004462	103007 8/12 48	16,22
50	8004477	103007 8/16 50	8004505	103007 8/5 50	8004491	103007 8/25 50	8004463	103007 8/12 50	
52	8004478	103007 8/16 52	8004506	103007 8/5 52	8004492	103007 8/25 52	8004464	103007 8/12 52	
54	8004479	103007 8/16 54	8004507	103007 8/5 54	8004493	103007 8/25 54	8004465	103007 8/12 54	
56	8004480	103007 8/16 56	8004508	103007 8/5 56	8004494	103007 8/25 56	8004466	103007 8/12 56	
58	8004481	103007 8/16 58	8004509	103007 8/5 58	8004495	103007 8/25 58	8004467	103007 8/12 58	
60	8004482	103007 8/16 60	8004510	103007 8/5 60	8004496	103007 8/25 60	8004468	103007 8/12 60	

Talla/Color	Negro/celeste.		Negro/verde lima.		Negro/naranja.		Negro/rojo.		€ / u.
	Ref.	Código	Ref.	Código	Ref.	Código	Ref.	Código	
34	8004385	103007 0/5 34	8004371	103007 0/25 34	8004357	103007 0/16 34	8004343	103007 0/12 34	
36	8004386	103007 0/5 36	8004372	103007 0/25 36	8004358	103007 0/16 36	8004344	103007 0/12 36	
38	8004387	103007 0/5 38	8004373	103007 0/25 38	8004359	103007 0/16 38	8004345	103007 0/12 38	
40	8004388	103007 0/5 40	8004374	103007 0/25 40	8004360	103007 0/16 40	8004346	103007 0/12 40	
42	8004389	103007 0/5 42	8004375	103007 0/25 42	8004361	103007 0/16 42	8004347	103007 0/12 42	
44	8004390	103007 0/5 44	8004376	103007 0/25 44	8004362	103007 0/16 44	8004348	103007 0/12 44	
46	8004391	103007 0/5 46	8004377	103007 0/25 46	8004363	103007 0/16 46	8004349	103007 0/12 46	
48	8004392	103007 0/5 48	8004378	103007 0/25 48	8004364	103007 0/16 48	8004350	103007 0/12 48	16,22
50	8004393	103007 0/5 50	8004379	103007 0/25 50	8004365	103007 0/16 50	8004351	103007 0/12 50	
52	8004394	103007 0/5 52	8004380	103007 0/25 52	8004366	103007 0/16 52	8004352	103007 0/12 52	
54	8004395	103007 0/5 54	8004381	103007 0/25 54	8004367	103007 0/16 54	8004353	103007 0/12 54	
56	8004396	103007 0/5 56	8004382	103007 0/25 56	8004368	103007 0/16 56	8004354	103007 0/12 56	
58	8004397	103007 0/5 58	8004383	103007 0/25 58	8004369	103007 0/16 58	8004355	103007 0/12 58	
60	8004398	103007 0/5 60	8004384	103007 0/25 60	8004370	103007 0/16 60	8004356	103007 0/12 60	

Talla/Color	Gris/amarillo.		Gris/naranja.		Azul marino/amarillo.		Azul marino/naranja.		€ / u.
	Ref.	Código	Ref.	Código	Ref.	Código	Ref.	Código	
34	8004065	103010S 8/20 34	8004051	103010S 8/19 34	8004037	103010S 1/20 34	8004023	103010S 1/19 34	
36	8004066	103010S 8/20 36	8004052	103010S 8/19 36	8004038	103010S 1/20 36	8004024	103010S 1/19 36	
38	8004067	103010S 8/20 38	8004053	103010S 8/19 38	8004039	103010S 1/20 38	8004025	103010S 1/19 38	
40	8004068	103010S 8/20 40	8004054	103010S 8/19 40	8004040	103010S 1/20 40	8004026	103010S 1/19 40	
42	8004069	103010S 8/20 42	8004055	103010S 8/19 42	8004041	103010S 1/20 42	8004027	103010S 1/19 42	
44	8004070	103010S 8/20 44	8004056	103010S 8/19 44	8004042	103010S 1/20 44	8004028	103010S 1/19 44	
46	8004071	103010S 8/20 46	8004057	103010S 8/19 46	8004043	103010S 1/20 46	8004029	103010S 1/19 46	
48	8004072	103010S 8/20 48	8004058	103010S 8/19 48	8004044	103010S 1/20 48	8004030	103010S 1/19 48	27,67
50	8004073	103010S 8/20 50	8004059	103010S 8/19 50	8004045	103010S 1/20 50	8004031	103010S 1/19 50	
52	8004074	103010S 8/20 52	8004060	103010S 8/19 52	8004046	103010S 1/20 52	8004032	103010S 1/19 52	
54	8004075	103010S 8/20 54	8004061	103010S 8/19 54	8004047	103010S 1/20 54	8004033	103010S 1/19 54	
56	8004076	103010S 8/20 56	8004062	103010S 8/19 56	8004048	103010S 1/20 56	8004034	103010S 1/19 56	
58	8004077	103010S 8/20 58	8004063	103010S 8/19 58	8004049	103010S 1/20 58	8004035	103010S 1/19 58	
60	8004078	103010S 8/20 60	8004064	103010S 8/19 60	8004050	103010S 1/20 60	8004036	103010S 1/19 60	



07

Bermuda bicolor stretch multibolsillos



103010S 0/20 34



103010S 0/19 34

Talla/Color	Negro/amarillo.		Negro/naranja.		€ / u.
	Ref.	Código	Ref.	Código	
34	8004009	103010S 0/20 34	8003995	103010S 0/19 34	27,67
36	8004010	103010S 0/20 36	8003996	103010S 0/19 36	
38	8004011	103010S 0/20 38	8003997	103010S 0/19 38	
40	8004012	103010S 0/20 40	8003998	103010S 0/19 40	
42	8004013	103010S 0/20 42	8003999	103010S 0/19 42	
44	8004014	103010S 0/20 44	8004000	103010S 0/19 44	
46	8004015	103010S 0/20 46	8004001	103010S 0/19 46	
48	8004016	103010S 0/20 48	8004002	103010S 0/19 48	
50	8004017	103010S 0/20 50	8004003	103010S 0/19 50	
52	8004018	103010S 0/20 52	8004004	103010S 0/19 52	
54	8004019	103010S 0/20 54	8004005	103010S 0/19 54	
56	8004020	103010S 0/20 56	8004006	103010S 0/19 56	
58	8004021	103010S 0/20 58	8004007	103010S 0/19 58	
60	8004022	103010S 0/20 60	8004008	103010S 0/19 60	

Bermuda stretch multibolsillos



103009S 8 34



103009S 7 34



103009S 46 34



103009S 1 34



103009S 0 34

Talla/Color	Gris.		Blanco.		Marrón.		Azul marino.		Negro.		€ / u.
	Ref.	Código	Ref.	Código	Ref.	Código	Ref.	Código	Ref.	Código	
34	8003981	103009S 8 34	8003967	103009S 7 34	8003953	103009S 46 34	8003939	103009S 1 34	8003925	103009S 0 34	21,96
36	8003982	103009S 8 36	8003968	103009S 7 36	8003954	103009S 46 36	8003940	103009S 1 36	8003926	103009S 0 36	
38	8003983	103009S 8 38	8003969	103009S 7 38	8003955	103009S 46 38	8003941	103009S 1 38	8003927	103009S 0 38	
40	8003984	103009S 8 40	8003970	103009S 7 40	8003956	103009S 46 40	8003942	103009S 1 40	8003928	103009S 0 40	
42	8003985	103009S 8 42	8003971	103009S 7 42	8003957	103009S 46 42	8003943	103009S 1 42	8003929	103009S 0 42	
44	8003986	103009S 8 44	8003972	103009S 7 44	8003958	103009S 46 44	8003944	103009S 1 44	8003930	103009S 0 44	
46	8003987	103009S 8 46	8003973	103009S 7 46	8003959	103009S 46 46	8003945	103009S 1 46	8003931	103009S 0 46	
48	8003988	103009S 8 48	8003974	103009S 7 48	8003960	103009S 46 48	8003946	103009S 1 48	8003932	103009S 0 48	
50	8003989	103009S 8 50	8003975	103009S 7 50	8003961	103009S 46 50	8003947	103009S 1 50	8003933	103009S 0 50	
52	8003990	103009S 8 52	8003976	103009S 7 52	8003962	103009S 46 52	8003948	103009S 1 52	8003934	103009S 0 52	
54	8003991	103009S 8 54	8003977	103009S 7 54	8003963	103009S 46 54	8003949	103009S 1 54	8003935	103009S 0 54	
56	8003992	103009S 8 56	8003978	103009S 7 56	8003964	103009S 46 56	8003950	103009S 1 56	8003936	103009S 0 56	
58	8003993	103009S 8 58	8003979	103009S 7 58	8003965	103009S 46 58	8003951	103009S 1 58	8003937	103009S 0 58	
60	8003994	103009S 8 60	8003980	103009S 7 60	8003966	103009S 46 60	8003952	103009S 1 60	8003938	103009S 0 60	

07

Bermuda multibolsillos Stretch en caja



Bermuda elástica, con elástico en cintura, bolsillo lateral y porta metro. Suministrado en caja.
Composición: 97% algodón, 3% spandex. 260 g/m2.



8734B-025-S



8734B-040-S



8734B-080-S

Talla/Color	Beige.		Azul.		Gris.		€ / u.
S	2401265	8734B-025-S	2401271	8734B-040-S	2401277	8734B-080-S	37,40
M	2401266	8734B-025-M	2401272	8734B-040-M	2401278	8734B-080-M	
L	2401267	8734B-025-L	2401273	8734B-040-L	2401279	8734B-080-L	
XL	2401268	8734B-025-XL	2401274	8734B-040-XL	2401280	8734B-080-XL	
XXL	2401269	8734B-025-XXL	2401275	8734B-040-XXL	2401281	8734B-080-XXL	
3XL	2401270	8734B-025-3XL	2401276	8734B-040-3XL	2401282	8734B-080-3XL	

Bermuda LIGHT Extreme



Bermuda estival en tejido softshell muy ligero con contrastes en simil cordura equipado con 6 bolsillos, más un bolsillo porta móvil y un porta metro. Refuerzo posterior para aumentar la resistencia. Tratamiento Cooldry. Se suministra con cinturón ajustable y en caja de cartón.
Composición: softshell 115 g/m2, 92% poliéster, 8% spandex. Contraste simil cordura 165 g/m2. Tratamiento Cooldry.



Talla/Color	Gris.		€ / u.
	Ref.	Código	
S	2401283	8836B-080-S	46,50
M	2401284	8836B-080-M	
L	2401285	8836B-080-L	
XL	2401286	8836B-080-XL	
XXL	2401287	8836B-080-XXL	
3XL	2401288	8836B-080-3XL	

Bermuda multibolsillos Stretch Extreme



Bermuda técnica multibolsillos en tejido elástico con inserciones en tejido elástico anti abrasión y ofreciendo una apariencia moderna y deportiva. Dispone de 9 bolsillos (incluido uno porta móvil). Triple costuras y tejido particularmente robusto garantizan una óptima resistencia incluso en las tareas más duras. Suministrado en una práctica caja.
Composición: 65% poliéster, 32% algodón, 3% spandex. 260 g/m2.



8834B-040-S



8834B-078-XS



8834B-080-XS



8834B-200-XS

Talla/Color	Azul.		Gris claro.		Gris.		Fango.		€ / u.
XS			2401295	8834B-078-XS	2401302	8834B-080-XS	2401309	8834B-200-XS	47,90
S	2401289	8834B-040-S	2401296	8834B-078-S	2401303	8834B-080-S	2401310	8834B-200-S	
M	2401290	8834B-040-M	2401297	8834B-078-M	2401304	8834B-080-M	2401311	8834B-200-M	
L	2401291	8834B-040-L	2401298	8834B-078-L	2401305	8834B-080-L	2401312	8834B-200-L	
XL	2401292	8834B-040-XL	2401299	8834B-078-XL	2401306	8834B-080-XL	2401313	8834B-200-XL	
XXL	2401293	8834B-040-XXL	2401300	8834B-078-XXL	2401307	8834B-080-XXL	2401314	8834B-200-XXL	
3XL	2401294	8834B-040-3XL	2401301	8834B-078-3XL	2401308	8834B-080-3XL	2401315	8834B-200-3XL	



Bermuda elástica2



Pantalones cortos de trabajo en tejido elástico blend con dos bolsillos delanteros, un bolsillo en la pierna izquierda, un bolsillo delantero retráctil para teléfono, dos bolsillos traseros y un bolsillo metro. Tres tuberías reflectantes proporcionan visibilidad en casos de poca visibilidad (donde no se requiere un producto certificado EN20471). Composición: 60% algodón, 37% poliéster, 3% lycra 220 g/m2.



9034B-040-S



9034B-80-S



9034B-81-S



9036B-049-S



9036B-081-S

Talla/Color	Azul.		Gris.		Antracita.		€ / u.
S	2401316	9034B-40-S	2401322	9034B-80-S	2401328	9034B-81-S	36,80
M	2401317	9034B-40-M	2401323	9034B-80-M	2401329	9034B-81-M	
L	2401318	9034B-40-L	2401324	9034B-80-L	2401330	9034B-81-L	
XL	2401319	9034B-40-XL	2401325	9034B-80-XL	2401331	9034B-81-XL	
XXL	2401320	9034B-40-XXL	2401326	9034B-80-XXL	2401332	9034B-81-XXL	
3XL	2401321	9034B-40-3XL	2401327	9034B-80-3XL	2401333	9034B-81-3XL	

Talla/Color	Azul avio.		Antracita.		€ / u.
S	2401334	9036B-049-S	2401342	9036B-081-S	47,45
M	2401335	9036B-049-M	2401343	9036B-081-M	
L	2401336	9036B-049-L	2401344	9036B-081-L	
XL	2401337	9036B-049-XL	2401345	9036B-081-XL	
XXL	2401338	9036B-049-XXL	2401346	9036B-081-XXL	
3XL	2401339	9036B-049-3XL	2401347	9036B-081-3XL	
4XL	2401340	9036B-049-4XL	2401348	9036B-081-4XL	
5XL	2401341	9036B-049-5XL	2401349	9036B-081-5XL	

Camiseta algodón 185 grs.



932/S



930/S

Talla/Color	Azulina/marino.		€ / u.
	Ref.	Código	
S	1000881	932/S	25,71
M	1000882	932/M	
L	1000883	932/L	
XL	1000884	932/XL	
XXL	1000885	932/XXL	

Talla/Color	Azulina/gris.		€ / u.
	Ref.	Código	
S	1000833	930/S	26,21
M	1000834	930/M	
L	1000835	930/L	
XL	1000836	930/XL	
XXL	1000837	930/XXL	

Camiseta algodón, bolsillo izquierdo



633/S



634/S

Talla/Color	Gris.		€ / u.
	Ref.	Código	
S	1000660	633/S	8,16
M	1000661	633/M	
L	1000014	633/L	
XL	1000015	633/XL	
XXL	1000016	633/XXL	

Talla/Color	Azul marino.		€ / u.
	Ref.	Código	
S	1000662	634/S	8,07
M	1000010	634/M	
L	1000011	634/L	
XL	1000012	634/XL	
XXL	1000013	634/XXL	

Camiseta STRETCH bicolor



Camiseta en algodón y elastano que ofrece una comodidad incomparable gracias a la transpirabilidad del algodón y la elasticidad del tejido. Las combinaciones de color disponibles las hacen compatibles con los pantalones de la gama Issa Line Stretch. Composición: 95% algodón, 5% elastano. 180 g/m².



Talla/Color	Beige.		Azul.		Gris.		€ / u.
	Ref.	Código	Ref.	Código	Ref.	Código	
S	2401359	8772-025-S	2401365	8772-040-S	2401371	8772-080-S	15,80
M	2401360	8772-025-M	2401366	8772-040-M	2401372	8772-080-M	
L	2401361	8772-025-L	2401367	8772-040-L	2401373	8772-080-L	
XL	2401362	8772-025-XL	2401368	8772-040-XL	2401374	8772-080-XL	
XXL	2401363	8772-025-XXL	2401369	8772-040-XXL	2401375	8772-080-XXL	
3XL	2401364	8772-025-3XL	2401370	8772-040-3XL	2401376	8772-080-3XL	

Camiseta STRETCH extreme



En algodón elastizado con bolsillo frontal e inserciones de tejido resistente a la abrasión en los hombros (Forrado en el interior para evitar el roce con la piel).



Talla/Color	Azul.		Gris.		€ / u.
	Ref.	Código	Ref.	Código	
S	2401380	8820NB-040-S	2401386	8820NB-078-S	17,20
M	2401379	8820NB-040-M	2401385	8820NB-078-M	
L	2401378	8820NB-040-L	2401384	8820NB-078-L	
XL	2401381	8820NB-040-XL	2401387	8820NB-078-XL	
XXL	2401382	8820NB-040-XXL	2401388	8820NB-078-XXL	
3XL	2401377	8820NB-040-3XL	2401383	8820NB-078-3XL	

Camiseta técnica



Talla/Color	Negro.		Naranja flúor.		Amarillo flúor.		Verde lima.		Rojo vivo.		Azul navy.		Blanco.		€ / u.
	Ref.	Código	Ref.	Código	Ref.	Código	Ref.	Código	Ref.	Código	Ref.	Código	Ref.	Código	
S	8003584	105506 0 S	8003589	105506 19 S	8003594	105506 20 S	8003599	105506 25 S	8003606	105506 56 S	8003611	105506 61 S	8003616	105506 7 S	7,84
M	8003585	105506 0 M	8003590	105506 19 M	8003595	105506 20 M	8003600	105506 25 M	8003605	105506 56 M	8003610	105506 61 M	8003615	105506 7 M	
L	8003586	105506 0 L	8003591	105506 19 L	8003596	105506 20 L	8003601	105506 25 L	8003604	105506 56 L	8003609	105506 61 L	8003614	105506 7 L	
XL	8003587	105506 0 XL	8003592	105506 19 XL	8003597	105506 20 XL	8003602	105506 25 XL	8003607	105506 56 XL	8003612	105506 61 XL	8003617	105506 7 XL	
XXL	8003588	105506 0 XXL	8003593	105506 19 XXL	8003598	105506 20 XXL	8003603	105506 25 XXL	8003608	105506 56 XXL	8003613	105506 61 XXL	8003618	105506 7 XXL	



07

Polo piqué de manga larga de algodón con elastano



Bolsillo en el pecho. Cierre velcro.



671/XS

681/XS

Talla/Color	Gris/negro.		€ / u.
	Ref.	Código	
XS	8001314	671/XS	37,31
S	8001315	671/S	
M	8001316	671/M	
L	8001317	671/L	
XL	8001318	671/XL	
XXL	8001319	671/XXL	
3XL	8001320	671/3XL	

Talla/Color	Azul/negro.		€ / u.
	Ref.	Código	
XS	8001321	681/XS	30,86
S	8001322	681/S	
M	8001323	681/M	
L	8001324	681/L	
XL	8001325	681/XL	
XXL	8001326	681/XXL	
3XL	8001327	681/3XL	

Polo transpirable manga corta, bolsillo



964/S

994/S

920/S

Talla/Color	Gris/negro.		€ / u.
	Ref.	Código	
XS	8001314	671/XS	37,31
S	8001315	671/S	
M	8001316	671/M	
L	8001317	671/L	
XL	8001318	671/XL	
XXL	8001319	671/XXL	
3XL	8001320	671/3XL	

Talla/Color	Azul/negro.		€ / u.
	Ref.	Código	
XS	8001321	681/XS	30,86
S	8001322	681/S	
M	8001323	681/M	
L	8001324	681/L	
XL	8001325	681/XL	
XXL	8001326	681/XXL	
3XL	8001327	681/3XL	

Talla/Color	Azulina/azul marino/gris.		€ / u.
	Ref.	Código	
S	1000875	920/S	29,15
M	1000876	920/M	
L	1000877	920/L	
XL	1000878	920/XL	
XXL	1000879	920/XXL	
3XL	1000880	920/3XL	

Polo piqué manga corta 100% algodón "Double Tuck", bolsillo



643/S

644/S

Talla/Color	Gris.		€ / u.
	Ref.	Código	
S	1000713	643/S	14,04
M		643/M	
L		643/L	
XL	1000714	643/XL	
XXL	1000715	643/XXL	

Talla/Color	Azul marino.		€ / u.
	Ref.	Código	
S	1000716	644/S	14,25
M	1000717	644/M	
L	1000718	644/L	
XL	1000719	644/XL	
XS	1000720	644/XXL	

Polo piqué manga corta 100% algodón orgánico. Greensource



Fabricado de algodón 100% ecológico por lo que no contiene en su composición sustancias químicas que pueden ser nocivas para algunas pieles más sensibles. Producto textil biodegradable. Respetuoso con el medio ambiente. Aporta transpirabilidad, comodidad y un tacto agradable. Certificado GOTS que avala el proceso de fabricación natural y ecológico de este artículo.



Talla/Color	Azul marino.		€ / u.
	Ref.	Código	
S	21060012	770/S	18,81
M	21060013	770/M	
L	21060014	770/L	
XL	21060015	770/XL	
XXL	21060016	770/XXL	

Polo piqué de manga corta de algodón con elastano



Bolsillo en el pecho. Cierre velcro.



670/XS



680/XS

Talla/Color	Gris/negro.		€ / u.
	Ref.	Código	
XS	8001293	670/XS	25,23
S	8001294	670/S	
M	8001295	670/M	
L	8001296	670/L	
XL	8001297	670/XL	
XXL	8001298	670/XXL	
3XL	8001299	670/3XL	

Talla/Color	Azul marino/negro.		€ / u.
	Ref.	Código	
XS	8001300	680/XS	25,22
S	8001301	680/S	
M	8001302	680/M	
L	8001303	680/L	
XL	8001304	680/XL	
XXL	8001305	680/XXL	
3XL	8001306	680/3XL	

Polo transpirable manga corta con tejido Cooldry



Polo de manga corta con tejido Cooldry ayuda a expulsar la humedad y el sudor de la piel hacia la capa externa, facilitando así la evaporación y manteniendo siempre la piel fresca y seca. Tiene un bolsillo en el pecho con cremallera y unos detalles reflectantes a la altura del pecho y en la espalda. En los laterales cuenta con un tejido técnico transpirable.



977B/S



977GY/S

Talla/Color	Gris.		Negro.		€ / u.
	Ref.	Código	Ref.	Código	
S	21060006	977GY/S	21060000	977B/S	31,55
M	21060007	977GY/M	21060001	977B/M	
L	21060008	977GY/L	21060002	977B/L	
XL	21060009	977GY/XL	21060003	977B/XL	
XXL	21060010	977GY/XXL	21060004	977B/XXL	
3XL	21060011	977GY/3XL	21060005	977B/3XL	

Polo manga larga bicolor Stretch



Polo de manga larga con algodón elastizado, perfecto para usar en el trabajo, combinado con los pantalones Stretch. El diseño moderno hace que también pueda ser usado en el tiempo libre.

Composición: 95% algodón, 5% elastán. 180 g/m2.



8776-040-S



8776-080-S

Talla/Color	Azul.		Gris.		€ / u.
	Ref.	Código	Ref.	Código	
S	2401389	8776-040-S	2401395	8776-080-S	26,30
M	2401390	8776-040-M	2401396	8776-080-M	
L	2401391	8776-040-L	2401397	8776-080-L	
XL	2401392	8776-040-XL	2401398	8776-080-XL	
XXL	2401393	8776-040-XXL	2401399	8776-080-XXL	
3XL	2401394	8776-040-3XL	2401400	8776-080-3XL	

Polo Stretch Extreme



Polo Extreme en algodón elastizado con bolsillo frontal e inserciones de tejido resistente a la abrasión en los hombros (Forrado en el interior para evitar el roce con la piel)



8825NB-40-S



8825NB-78-S

Talla/Color	Azul.		Gris.		€ / u.
	Ref.	Código	Ref.	Código	
S	2401401	8825NB-40-S	2401407	8825NB-78-S	19,80
M	2401402	8825NB-40-M	2401408	8825NB-78-M	
L	2401403	8825NB-40-L	2401409	8825NB-78-L	
XL	2401404	8825NB-40-XL	2401410	8825NB-78-XL	
XXL	2401405	8825NB-40-XXL	2401411	8825NB-78-XXL	
3XL	2401406	8825NB-40-3XL	2401412	8825NB-78-3XL	

Polo BOOM



Polo línea "Boom" de algodón elástico con bolsillo delantero.



8815B-040-S



8815B-080-S

Talla/Color	Azul.		Gris.		€ / u.
	Ref.	Código	Ref.	Código	
S	2401416	8815B-040-S	2401422	8815B-080-S	29,80
M	2401415	8815B-040-M	2401421	8815B-080-M	
L	2401414	8815B-040-L	2401420	8815B-080-L	
XL	2401417	8815B-040-XL	2401423	8815B-080-XL	
XXL	2401418	8815B-040-XXL	2401424	8815B-080-XXL	
3XL	2401413	8815B-040-3XL	2401419	8815B-080-3XL	

Polo bicolor con raya manga corta



105505 0/19 XS 105505 0/20 XS 105505 61/20 XS 105505 61/19 XS 105505 8/19 XS 105505 8/20 XS

Talla/Color	Negro/naranja flúor.		Negro/naranja flúor.		Azul navy/naranja flúor.		Azul navy/naranja flúor.		Gris/naranja flúor.		Gris/naranja flúor.		€ / u.
	Ref.	Código	Ref.	Código	Ref.	Código	Ref.	Código	Ref.	Código	Ref.	Código	
XS	8003542	105505 0/19 XS	8003549	105505 0/20 XS	8003556	105505 61/20 XS	8003563	105505 61/19 XS	8003570	105505 8/19 XS	8003577	105505 8/20 XS	16,09
S	8003543	105505 0/19 S	8003550	105505 0/20 S	8003557	105505 61/20 S	8003564	105505 61/19 S	8003571	105505 8/19 S	8003578	105505 8/20 S	
M	8003544	105505 0/19 M	8003551	105505 0/20 M	8003558	105505 61/20 M	8003565	105505 61/19 M	8003572	105505 8/19 M	8003579	105505 8/20 M	
L	8003545	105505 0/19 L	8003552	105505 0/20 L	8003559	105505 61/20 L	8003566	105505 61/19 L	8003573	105505 8/19 L	8003580	105505 8/20 L	
XL	8003546	105505 0/19 XL	8003553	105505 0/20 XL	8003560	105505 61/20 XL	8003567	105505 61/19 XL	8003574	105505 8/19 XL	8003581	105505 8/20 XL	
XXL	8003547	105505 0/19 XXL	8003554	105505 0/20 XXL	8003561	105505 61/20 XXL	8003568	105505 61/19 XXL	8003575	105505 8/19 XXL	8003582	105505 8/20 XXL	
3XL	8003548	105505 0/19 3XL	8003555	105505 0/20 3XL	8003562	105505 61/20 3XL	8003569	105505 61/19 3XL	8003576	105505 8/19 3XL	8003583	105505 8/20 3XL	

Polo de manga corta bicolor



105504 0/12 XS 105504 0/16 XS 105504 0/25 XS 105504 0/5 XS 105504 61/12XS 105504 61/16XS 105504 61/5 XS 105504 61/25XS

Talla/Color	Negro/rojo.		Negro/naranja.		Negro/verde lima.		Negro/celeste.		€ / u.
	Ref.	Código	Ref.	Código	Ref.	Código	Ref.	Código	
XS	8004263	105504 0/12 XS	8004270	105504 0/16 XS	8004277	105504 0/25 XS	8004284	105504 0/5 XS	15,90
S	8004261	105504 0/12 S	8004268	105504 0/16 S	8004275	105504 0/25 S	8004282	105504 0/5 S	
M	8004260	105504 0/12 M	8004267	105504 0/16 M	8004274	105504 0/25 M	8004281	105504 0/5 M	
L	8004259	105504 0/12 L	8004266	105504 0/16 L	8004273	105504 0/25 L	8004280	105504 0/5 L	
XL	8004262	105504 0/12 XL	8004269	105504 0/16 XL	8004276	105504 0/25 XL	8004283	105504 0/5 XL	
XXL	8004264	105504 0/12 XXL	8004271	105504 0/16 XXL	8004278	105504 0/25 XXL	8004285	105504 0/5 XXL	
3XL	8004265	105504 0/12 3XL	8004272	105504 0/16 3XL	8004279	105504 0/25 3XL	8004286	105504 0/5 3XL	

Talla/Color	Azul navy/rojo.		Azul navy/naranja flúor.		Azul navy/verde lima.		Azul navy/celeste.		€ / u.
	Ref.	Código	Ref.	Código	Ref.	Código	Ref.	Código	
XS	8004291	105504 61/12XS	8004298	105504 61/16XS	8004305	105504 61/25XS	8004312	105504 61/5 XS	15,90
S	8004289	105504 61/12S	8004296	105504 61/16S	8004303	105504 61/25S	8004310	105504 61/5 S	
M	8004288	105504 61/12M	8004295	105504 61/16M	8004302	105504 61/25M	8004309	105504 61/5 M	
L	8004287	105504 61/12L	8004294	105504 61/16L	8004301	105504 61/25L	8004308	105504 61/5 L	
XL	8004290	105504 61/12XL	8004297	105504 61/16XL	8004304	105504 61/25XL	8004311	105504 61/5 XL	
XXL	8004292	105504 61/12XXL	8004299	105504 61/16XXL	8004306	105504 61/25XXL	8004313	105504 61/5 XXL	
3XL	8004293	105504 61/123XL	8004300	105504 61/163XL	8004307	105504 61/253XL	8004314	105504 61/5 3XL	

Polo de manga corta bicolor



105504 8/5 XS

105504 8/25 XS

105504 8/16 XS

105504 8/12 XS

Talla/Color	Gris/rojo.		Gris/naranja.		Gris/verde lima.		Gris/celeste.		€ / u.
	Ref.	Código	Ref.	Código	Ref.	Código	Ref.	Código	
XS	8004319	105504 8/12 XS	8004326	105504 8/16 XS	8004333	105504 8/25 XS	8004340	105504 8/5 XS	15,90
S	8004317	105504 8/12 S	8004324	105504 8/16 S	8004331	105504 8/25 S	8004338	105504 8/5 S	
M	8004316	105504 8/12 M	8004323	105504 8/16 M	8004330	105504 8/25 M	8004337	105504 8/5 M	
L	8004315	105504 8/12 L	8004322	105504 8/16 L	8004329	105504 8/25 L	8004336	105504 8/5 L	
XL	8004318	105504 8/12 XL	8004325	105504 8/16 XL	8004332	105504 8/25 XL	8004339	105504 8/5 XL	
XXL	8004320	105504 8/12 XXL	8004327	105504 8/16 XXL	8004334	105504 8/25 XXL	8004341	105504 8/5 XXL	
3XL	8004321	105504 8/12 3XL	8004328	105504 8/16 3XL	8004335	105504 8/25 3XL	8004342	105504 8/5 3XL	

Chaleco multibolsillos acolchado de algodón



Chaleco de trabajo acolchado para proteger del frío, Cintura ajustable con botones a presión, Bolsillos con fuelle para mayor capacidad y practicidad, Tejido exterior y forro de algodón 100%. Mejor confort y transpirabilidad

Talla/Color	Gris.		€ / u.
	Ref.	Código	
S	2401425	860GY/S	61,91
M	2401426	860GY/M	
L	2401427	860GY/L	
XL	2401428	860GY/XL	
XXL	2401429	860GY/XXL	



Chaleco acolchado multibolsillos



Chaleco con cremallera central completa oculta con tapeta. Tapeta con cierre de velcros. Cinturillas elásticas laterales. Cortavientos en sisa. 2 bolsillos fuelle en la parte inferior con tapeta y velcro. 2 bolsillos laterales. 1 bolsillo fuelle en el pecho con tapeta y velcro. 1 bolsillo de fuelle en el pecho con tapeta y velcro y en el lateral del bolsillo compartimentos para bolígrafos.



HERO BLACK XS



HERO GREY XS



HERO NAVY XS

Talla/Color	Negro.		Gris.		Azul navy.		€ / u.
	Ref.	Código	Ref.	Código	Ref.	Código	
XS	2401438	HERO BLACK XS	2401447	HERO GREY XS	2401456	HERO NAVY XS	22,27
S	2401436	HERO BLACK S	2401445	HERO GREY S	2401454	HERO NAVY S	
M	2401435	HERO BLACK M	2401444	HERO GREY M	2401453	HERO NAVY M	
L	2401434	HERO BLACK L	2401443	HERO GREY L	2401452	HERO NAVY L	
XL	2401437	HERO BLACK XL	2401446	HERO GREY XL	2401455	HERO NAVY XL	
2XL	2401430	HERO BLACK 2XL	2401439	HERO GREY 2XL	2401448	HERO NAVY 2XL	
3XL	2401431	HERO BLACK 3XL	2401440	HERO GREY 3XL	2401449	HERO NAVY 3XL	
4XL	2401432	HERO BLACK 4XL	2401441	HERO GREY 4XL	2401450	HERO NAVY 4XL	
5XL	2401433	HERO BLACK 5XL	2401442	HERO GREY 5XL	2401451	HERO NAVY 5XL	

Chaleco Helsinki Poliester Forro Interior



Chaleco multibolsillos acolchado ligero en color gris. Ligeramente impermeable. Más largo en la parte trasera para cubrir la zona lumbar. Cintura elástica en los laterales. 100% poliester Oxford. Relleno de poliéster.

Talla/Color	Gris.		€ / u.
	Ref.	Código	
XS	2401457	835GY/XS	27,95
S	2401458	835GY/S	
M	2401459	835GY/M	
L	2401460	835GY/L	
XL	2401461	835GY/XL	
XXL	2401462	835GY/XXL	
3XL	2401463	835GY/3XL	



PROFESIONAL. Chaleco multibolsillos poliester/PU con forro polar



Chaleco multibolsillos con cuatro bolsillos frontales, los dos de arriba con cierre a presión y los dos de abajo con cierre velcro y cremallera. Goma elástica sobre los lados para un mejor ajuste. Apertura para serigrafía.

Talla/Color	Negro/naranja.		€ / u.
	Ref.	Código	
XS	1000912	837NEGRO/XS	53,78
S	1000913	837NEGRO/S	
M	1000914	837NEGRO/M	
L	1000915	837NEGRO/L	
XL	1000916	837NEGRO/XL	
XXL	1000917	837NEGRO/XXL	
3XL	1000918	837NEGRO/3XL	



REPORTERIO BASIC. Chaleco 4 bolsillos. Acolchado 160 grs./m2



Chaleco multibolsillos Dispone de cuatro bolsillos externos. Acabado liso. Cierre de cremallera y tapeta con botones a presión. Espalda más larga.

Talla/Color	Azul.		€ / u.
	Ref.	Código	
S	1000934	882BMARINO/S	37,14
M	1000935	882BMARINO/M	
L	1000936	882BMARINO/L	
XL	1000937	882BMARINO/XL	
XXL	1000938	882BMARINO/XXL	
3XL	1000939	882BMARINO/3XL	



WESTPORT. Chaleco multibolsillos. Forro cuadros



Chaleco multibolsillos con tres bolsillos frontales con corchetes, dos bolsillos con cremallera y dos bolsillos laterales con velcro, un bolsillo interior. Cortavientos en mangas. Cierre frontal con cremallera y botones a presión.

Talla/Color	Azul marino.		€ / u.
	Ref.	Código	
S	1000891	860/S	61,91
M	1000892	860/M	
L	1000893	860/L	
XL	1000894	860/XL	
XXL	1000895	860/XXL	



TEIDE. Chaleco multibolsillos. Acolchado 220 grs. Forro cuadros



Cuatro bolsillos externos, el superior izquierdo para móvil y uno interno. Cierre con cremallera y botones a presión. Cortavientos en mangas.



Talla/Color	Azul.		€ / u.
	Ref.	Código	
S	1000896	832/S	53,22
M	1000897	832/M	
L	1000898	832/L	
XL	1000899	832/XL	
XXL	1000900	832/XXL	

Chaleco acolchado bicolor



205902 8/12 S



205902 8/16 S



205902 8/25 S



205902 8/5 S



205902 61/5 S



205902 61/25S



205902 61/12S



205902 61/16S



205902 0/12 S



205902 0/16 S



205902 0/25 S



205902 0/5 S

Talla/Color	Gris/rojo.		Gris/naranja.		Gris/verde lima.		Gris/celeste.		€ / u.
	Ref.	Código	Ref.	Código	Ref.	Código	Ref.	Código	
S	8004153	205902 8/12 S	8004159	205902 8/16 S	8004165	205902 8/25 S	8004171	205902 8/5 S	24,58
M	8004152	205902 8/12 M	8004158	205902 8/16 M	8004164	205902 8/25 M	8004170	205902 8/5 M	
L	8004151	205902 8/12 L	8004157	205902 8/16 L	8004163	205902 8/25 L	8004169	205902 8/5 L	
XL	8004154	205902 8/12 XL	8004160	205902 8/16 XL	8004166	205902 8/25 XL	8004172	205902 8/5 XL	
XXL	8004155	205902 8/12 XXL	8004161	205902 8/16 XXL	8004167	205902 8/25 XXL	8004173	205902 8/5 XXL	
3XL	8004156	205902 8/12 3XL	8004162	205902 8/16 3XL	8004168	205902 8/25 3XL	8004174	205902 8/5 3XL	

Talla/Color	Azul navy/celeste.		Azul navy/verde lima.		Azul navy/naranja.		Azul navy/rojo.		€ / u.
	Ref.	Código	Ref.	Código	Ref.	Código	Ref.	Código	
S	8004147	205902 61/5 S	8004141	205902 61/25S	8004135	205902 61/16S	8004129	205902 61/12S	24,58
M	8004146	205902 61/5 M	8004140	205902 61/25M	8004134	205902 61/16M	8004128	205902 61/12M	
L	8004145	205902 61/5 L	8004139	205902 61/25L	8004133	205902 61/16L	8004127	205902 61/12L	
XL	8004148	205902 61/5 XL	8004142	205902 61/25XL	8004136	205902 61/16XL	8004130	205902 61/12XL	
XXL	8004149	205902 61/5 XXL	8004143	205902 61/25XXL	8004137	205902 61/16XXL	8004131	205902 61/12XXL	
3XL	8004150	205902 61/5 3XL	8004144	205902 61/253XL	8004138	205902 61/163XL	8004132	205902 61/123XL	

Talla/Color	Negro/celeste.		Negro/verde lima.		Negro/naranja.		Negro/rojo.		€ / u.
	Ref.	Código	Ref.	Código	Ref.	Código	Ref.	Código	
S	8004123	205902 0/5 S	8004117	205902 0/25 S	8004111	205902 0/16 S	8004105	205902 0/12 S	24,58
M	8004122	205902 0/5 M	8004116	205902 0/25 M	8004110	205902 0/16 M	8004104	205902 0/12 M	
L	8004121	205902 0/5 L	8004115	205902 0/25 L	8004109	205902 0/16 L	8004103	205902 0/12 L	
XL	8004124	205902 0/5 XL	8004118	205902 0/25 XL	8004112	205902 0/16 XL	8004106	205902 0/12 XL	
XXL	8004125	205902 0/5 XXL	8004119	205902 0/25 XXL	8004113	205902 0/16 XXL	8004107	205902 0/12 XXL	
3XL	8004126	205902 0/5 3XL	8004120	205902 0/25 3XL	8004114	205902 0/16 3XL	8004108	205902 0/12 3XL	

07

Chaleco acolchado ligero, 100% poliéster



Chaleco acolchado con cierre frontal de cremallera. Dispone de dos bolsillos exteriores con cierre de cremallera.



2881DN/S



2881G/S

Talla/Color	Azul marino.		Gris.		€ / u.
	Ref.	Código	Ref.	Código	
S	8001356	2881DN/S	8001362	2881G/S	32,08
M	8001357	2881DN/M	8001363	2881G/M	
L	8001358	2881DN/L	8001364	2881G/L	
XL	8001359	2881DN/XL	8001365	2881G/XL	
XXL	8001360	2881DN/XXL	8001366	2881G/XXL	
3XL	8001361	2881DN/3XL	8001367	2881G/3XL	

Chaleco sarga multibolsillos



105901 8 S



105901 61 S



105901 46 S



105901 0 S

Talla/Color	Gris.		Azul navy.		Beige arena.		Negro.		€ / u.
	Ref.	Código	Ref.	Código	Ref.	Código	Ref.	Código	
S	8004099	105901 8 S	8004093	105901 61 S	8004087	105901 46 S	8004081	105901 0 S	16,52
M	8004098	105901 8 M	8004092	105901 61 M	8004086	105901 46 M	8004080	105901 0 M	
L	8004097	105901 8 L	8004091	105901 61 L	8004085	105901 46 L	8004079	105901 0 L	
XL	8004100	105901 8 XL	8004094	105901 61 XL	8004088	105901 46 XL	8004082	105901 0 XL	
XXL	8004101	105901 8 XXL	8004095	105901 61 XXL	8004089	105901 46 XXL	8004083	105901 0 XXL	
3XL	8004102	105901 8 3XL	8004096	105901 61 3XL	8004090	105901 46 3XL	8004084	105901 0 3XL	

Chaleco NÁUTICO con forro polar



Talla/Color	Beige.		€ / u.
	Ref.	Código	
L	8000222	288-VPML	28,80
M	8000223	288-VPMM	
S	8000224	288-VPMS	
XL	8000225	288-VPMXL	
XXL	8000226	288-VPMXXL	
XXL	8000227	288-VPMXXXL	



07

Chaleco S.W.A.T. con forro polar



Talla/Color	Negro.		€ / u.
	Ref.	Código	
L	8000228	288-VPNL	32,00
M	8000229	288-VPNM	
XL	8000231	288-VPNXL	
XXL	8000232	288-VPNXXL	
XXL	8000233	288-VPNXXXL	



Chaleco SNAPPY



Chaleco SOFTSHELL con tres bolsillos externos y un práctico bolsillo interno.

Cuenta con una membrana que garantiza la transpirabilidad e impermeabilidad de la prenda. Detalles reflectantes para aumentar la visibilidad del usuario.

Composición: SOFTSHELL (94% poliéster / 6% spandex) con membrana TPU W/P 8.000 y MVP 1.000 g/m²/24 h.



04509-40-XS



04509-80-XS



04509-70-XS



04509-60-XS

Talla/Color	Azul.		Gris.		Rojo.		Negro.		€ / u.
	Ref.	Código	Ref.	Código	Ref.	Código	Ref.	Código	
XS	2401464	04509-40-XS	2401471	04509-80-XS	2401478	04509-70-XS	2401485	04509-60-XS	35,60
S	2401465	04509-40-S	2401472	04509-80-S	2401479	04509-70-S	2401486	04509-60-S	
M	2401466	04509-40-M	2401473	04509-80-M	2401480	04509-70-M	2401487	04509-60-M	
L	2401467	04509-40-L	2401474	04509-80-L	2401481	04509-70-L	2401488	04509-60-L	
XL	2401468	04509-40-XL	2401475	04509-80-XL	2401482	04509-70-XL	2401489	04509-60-XL	
XXL	2401469	04509-40-XXL	2401476	04509-80-XXL	2401483	04509-70-XXL	2401490	04509-60-XXL	
3XL	2401470	04509-40-3XL	2401477	04509-80-3XL	2401484	04509-70-3XL	2401491	04509-60-3XL	

Parka básica nylon sobre PVC con forro nylon



Parka básica acolchada. Dispone de cuatro bolsillos exteriores y uno interno. Capucha interna con cierre de cremallera.

Talla/Color	Azul marino.		€ / u.
	Ref.	Código	
S	1011900	820AZUL/S	50,48
M	1011901	820AZUL/M	
L	1011902	820AZUL/L	
XL	1011903	820AZUL/XL	
XXL	1011904	820AZUL/XXL	
3XL	1011905	820AZUL/3XL	



TIMBER. Parka poliester “pongee” con recubrimiento PVC



Cierre con cremallera y corchetes. Cuatro bolsillos frontales y un bolsillo doble y uno interior. Capucha interna con cierre velcro.

Talla/Color	Azul.		€ / u.
	Ref.	Código	
S	1000971	878/S	113,63
M	1000972	878/M	
L	1000973	878/L	
XL	1000974	878/XL	
XXL	1000975	878/XXL	



Chaqueta poliester/algodón tejido 240 grs.



Dispone de dos bolsillos superiores, dos inferiores con aperturas laterales y un bol lateral en la manga. Cierre de cremallera con tapeta, cuello con botones a presión, y media cintura elástica y ventilación en axilas.



941/S



942/S

Talla/Color	Azulina/gris.		€ / u.
	Ref.	Código	
S	1000820	941/S	58,46
M	1000821	941/M	
L	1000822	941/L	
XL	1000823	941/XL	
XXL	1000824	941/XXL	

Talla/Color	Azulina.		€ / u.
	Ref.	Código	
S	1000862	942/S	55,73
M	1000863	942/M	
L	1000864	942/L	
XL	1000865	942/XL	
XXL	1000866	942/XXL	

Chaqueta multibolsillos de algodón/poliester y elastano



Chaqueta multibolsillos. Bolsillos laterales con cierre de cremallera. Puños elásticos. Elástico en la cintura. Cierre frontal con cremallera y tapeta con velcro.

Talla/Color	Gris/negro.		€ / u.
	Ref.	Código	
XS	8001251	170/XS	99,80
S	8001252	170/S	
M	8001253	170/M	
L	8001254	170/L	
XL	8001255	170/XL	
XXL	8001256	170/XXL	
3XL	8001257	170/3XL	



Chaqueta cortavientos de poliester/elastano



Chaqueta de tejido cortavientos triple capa con membrana TPU. Dispone de tres bolsillos frontales con cierre cremallera. Puño elástico de lycra® para mayor ajuste en la muñeca. Refuerzo en hombro y laterales

Talla/Color	Camuflaje verde.		€ / u.
	Ref.	Código	
S	8001392	3894/S	72,75
M	8001393	3894/M	
L	8001394	3894/L	
XL	8001395	3894/XL	
XXL	8001396	3894/XXL	
3XL	8001397	3894/3XL	



Cazadora multibolsillos de poliéster/algodón



Chaqueta multibolsillos con puños elásticos, elásticos en la cintura, cierre de cremallera y velcro con tapeta.

Talla/Color	Gris/negro/naranja.		€ / u.
	Ref.	Código	
S	1000731	960/S	80,08
M	1000732	960/M	
L	1000733	960/L	
XL	1000734	960/XL	
XXL	1000735	960/XXL	
3XL	1000736	960/3XL	



Cazadora algodón supertop 270 grs.



488-CGSUPTOP48



488-CNSUPTOP48



488-CASUPTOP48



488-CSUPTOP48

Talla/Color	Gris.		Negro.		Azul marino.		Azulina.		€ / u.
	Ref.	Código	Ref.	Código	Ref.	Código	Ref.	Código	
48	1000278	488-CGSUPTOP48	1000289	488-CNSUPTOP48	1000267	488-CASUPTOP48	1000311	488-CSUPTOP48	23,68
50	1000279	488-CGSUPTOP50	1000290	488-CNSUPTOP50	1000268	488-CASUPTOP50	1000312	488-CSUPTOP50	
52	1000280	488-CGSUPTOP52	1000291	488-CNSUPTOP52	1000269	488-CASUPTOP52	1000313	488-CSUPTOP52	
54	1000281	488-CGSUPTOP54	1000292	488-CNSUPTOP54	1000270	488-CASUPTOP54	1000314	488-CSUPTOP54	
56	1000282	488-CGSUPTOP56	1000293	488-CNSUPTOP56	1000271	488-CASUPTOP56	1000315	488-CSUPTOP56	
58	1000283	488-CGSUPTOP58	1000294	488-CNSUPTOP58	1000272	488-CASUPTOP58	1000316	488-CSUPTOP58	
60	1000284	488-CGSUPTOP60	1000295	488-CNSUPTOP60	1000273	488-CASUPTOP60	1000317	488-CSUPTOP60	
62	1000285	488-CGSUPTOP62	1000296	488-CNSUPTOP62	1000274	488-CASUPTOP62	1000318	488-CSUPTOP62	
64	1000286	488-CGSUPTOP64	1000297	488-CNSUPTOP64	1000275	488-CASUPTOP64	1000319	488-CSUPTOP64	
66	1000287	488-CGSUPTOP66	1000298	488-CNSUPTOP66	1000276	488-CASUPTOP66	1000320	488-CSUPTOP66	
68	1000288	488-CGSUPTOP68	1000299	488-CNSUPTOP68	1000277	488-CASUPTOP68	1000321	488-CSUPTOP68	

Cazadora algodón con cremallera 200 grs.



Talla/Color	Azulina.		€ / u.
	Ref.	Código	
48	1000190	388-CE48	16,51
50	1000191	388-CE50	
52	1000192	388-CE52	
54	1000193	388-CE54	
56	1000194	388-CE56	
58	1000195	388-CE58	
60	1000196	388-CE60	
62	1000197	388-CE62	
64	1000198	388-CE64	
66	1000199	388-CE66	





Cazadora tergal con cremallera 200 grs.

Talla/Color	Azulina.		€/ u.
	Ref.	Código	
48	1000201	388-C48	15,87
50	1000202	388-C50	
52	1000203	388-C52	
54	1000204	388-C54	
56	1000205	388-C56	
58	1000206	388-C58	
60	1000207	388-C60	
62	1000208	388-C62	
64	1000209	388-C64	
66	1000210	388-C66	
68	1000211	388-C68	



Cazadora tergal 200 grs.



388-CAM 48



388-CB 48



388-CG 48

Talla/Color	Azul marino.		Blanco.		Gris.		€/ u.
	Ref.	Código	Ref.	Código	Ref.	Código	
48	1000212	388-CAM 48	1000223	388-CB 48	1000234	388-CG 48	15,87
50	1000213	388-CAM 50	1000224	388-CB 50	1000235	388-CG 50	
52	1000214	388-CAM 52	1000225	388-CB 52	1000236	388-CG 52	
54	1000215	388-CAM 54	1000226	388-CB 54	1000237	388-CG 54	
56	1000216	388-CAM 56	1000227	388-CB 56	1000238	388-CG 56	
58	1000217	388-CAM 58	1000228	388-CB 58	1000239	388-CG 58	
60	1000218	388-CAM 60	1000229	388-CB 60	1000240	388-CG 60	
62	1000219	388-CAM 62	1000230	388-CB 62	1000241	388-CG 62	
64	1000220	388-CAM 64	1000231	388-CB 64	1000242	388-CG 64	
66	1000221	388-CAM 66	1000232	388-CB 66	1000243	388-CG 66	
68	1000222	388-CAM 68	1000233	388-CB 68	1000244	388-CG 68	



Cazadora tejido vaquero STRETCH

Talla/Color	Azul marino.		€/ u.
	Ref.	Código	
48-50	1002606	588-CV 4850	37,76
52-54	1002607	588-CV 5254	
56-58	1002608	588-CV 5658	
60-62	1002609	588-CV 6062	
64-66	1002610	588-CV 6466	
68-70	1002611	588-CV 6870	



Cazadora SERIE PRO "CANVAS Line" tergal



588-CAZA 4850



588-CRN 4850



588-CANE 4850



588-CNEG 4850



588-CN 4850



588-CBG 4850

Talla/Color	Azul marino/azulina.		Rojo/negro.		Azul/negro.		Gris/negro.		Negro.		Blanca/gris.		€ / u.
	Ref.	Código	Ref.	Código	Ref.	Código	Ref.	Código	Ref.	Código	Ref.	Código	
48-50	8000502	588-CAZA 4850	8000472	588-CRN 4850	8000478	588-CANE 4850	8000484	588-CNEG 4850	8000490	588-CN 4850	8000496	588-CBG 4850	31,36
52-54	8000503	588-CAZA 5254	8000473	588-CRN 5254	8000479	588-CANE 5254	8000485	588-CNEG 5254	8000491	588-CN 5254	8000497	588-CBG 5254	
56-58	8000504	588-CAZA 5658	8000474	588-CRN 5658	8000480	588-CANE 5658	8000486	588-CNEG 5658	8000492	588-CN 5658	8000498	588-CBG 5658	
60-62	8000505	588-CAZA 6062	8000475	588-CRN 6062	8000481	588-CANE 6062	8000487	588-CNEG 6062	8000493	588-CN 6062	8000499	588-CBG 6062	
64-66	8000506	588-CAZA 6466	8000476	588-CRN 6466	8000482	588-CANE 6466	8000488	588-CNEG 6466	8000494	588-CN 6466	8000500	588-CBG 6466	
68-70	8000507	588-CAZA 6870	8000477	588-CRN 6870	8000483	588-CANE 6870	8000489	588-CNEG 6870	8000495	588-CN 6870	8000501	588-CBG 6870	

Cazadora soft shell



206005 0 S



206005 12 S



206005 61 S



206005 8 S

Talla/Color	Negro.		Rojo.		Azul navy.		Gris.		€ / u.
	Ref.	Código	Ref.	Código	Ref.	Código	Ref.	Código	
S	8003903	206005 0 S	8003909	206005 12 S	8003915	206005 61 S	8003921	206005 8 S	37,98
M	8003902	206005 0 M	8003908	206005 12 M	8003914	206005 61 M	8003920	206005 8 M	
L	8003901	206005 0 L	8003907	206005 12 L	8003913	206005 61 L	8003919	206005 8 L	
XL	8003904	206005 0 XL	8003910	206005 12 XL	8003916	206005 61 XL	8003922	206005 8 XL	
XXL	8003905	206005 0 XXL	8003911	206005 12 XXL	8003917	206005 61 XXL	8003923	206005 8 XXL	
3XL	8003906	206005 0 3XL	8003912	206005 12 3XL	8003918	206005 61 3XL	8003924	206005 8 3XL	

Chaqueta cortavientos con forro micro polar interior y membrana TPU



Chaqueta cortavientos con forro micro polar interior y membrana TPU. Tejido de triple capa. Puño ajustable interior y cierre ajustable en el exterior. Dispone de dos bolsillos frontales con cremallera. Elástico interior ajustable en la cadera.



894DNNEW/S



894BNEW/S

Talla/Color	Azul marino.		Negro.		€ / u.
	Ref.	Código	Ref.	Código	
S	21060221	894DNNEW/S	21060227	894BNEW/S	70,47
M	21060222	894DNNEW/M	21060228	894BNEW/M	
L	21060223	894DNNEW/L	21060229	894BNEW/L	
XL	21060224	894DNNEW/XL	21060230	894BNEW/XL	
XXL	21060225	894DNNEW/XXL	21060231	894BNEW/XXL	
3XL	21060226	894DNNEW/3XL	21060232	894BNEW/3XL	

ORION. Jersey lana/acrílico de 750 grs.



Jersey con refuerzos. Cremallera hasta pecho. Refuerzo en hombros y codos. Bolsillo frontal superior con tapeta y cierre velcro.



899B/S



899DN/S

Talla/Color	Negro.		Azul marino.		€ / u.
	Ref.	Código	Ref.	Código	
S	1000987	899B/S	1000993	899DN/S	44,80
M	1000988	899B/M	1000994	899DN/M	
L	1000989	899B/L	1000995	899DN/L	
XL	1000990	899B/XL	1000996	899DN/XL	
XXL	1000991	899B/XXL	1000997	899DN/XXL	
3XL	1000992	899B/3XL	1100998	899DN/3XL	

SPLENDOR. Jersey forro polar 100% poliéster de 280 grs.



Sudadera con forro polar. Cremallera central hasta el pecho. Bolsillos laterales con cierre cremallera. Cuello y puños elásticos.



Talla/Color	Azul marino.		€ / u.
	Ref.	Código	
XS	1001074	897/XS	49,11
S	1001075	897/S	
M	1001076	897/M	
L	1001077	897/L	
XL	1001078	897/XL	
XXL	1001079	897/XXL	

Chaqueta de punto



Talla/Color	Negro/negro.		Azul navy/negro.		Gris/negro.		€ / u.
	Ref.	Código	Ref.	Código	Ref.	Código	
S	20020720	206008 0/0 S	20020727	206008 61/0 S	20020734	206008 8/0 S	45,55
M	20020719	206008 0/0 M	20020726	206008 61/0 M	20020733	206008 8/0 M	
L	20020718	206008 0/0 L	20020725	206008 61/0 L	20020732	206008 8/0 L	
XL	20020721	206008 0/0 XL	20020728	206008 61/0 XL	20020735	206008 8/0 XL	
XXL	20020723	206008 0/0 XXL	20020730	206008 61/0 XXL	20020737	206008 8/0 XXL	
3XL	20020724	206008 0/0 3XL	20020731	206008 61/0 3XL	20020738	206008 8/0 3XL	



Chaqueta



Chaqueta elástica multibolsillos. Con cremallera completa. 2 bolsillos de apertura inclinada en la parte delante a la altura de cintura. Bolsillo oculto de apertura vertical en pecho izquierdo. 4 bolsillos dobles traseros a la altura del lumbar, estilo ciclismo. Cierre con velcro en los puños para mayor ajuste y protección. Detalle de líneas reflectantes en hombros por la parte delantera y trasera. Cuello alto.



JANIS GREY/GREY XS



JANIS NAVY/NAVY XS

Talla/Color	Gris-Gris.		Azul navy/Azul navy.		€ / u.
	Ref.	Código	Ref.	Código	
XS	2401498	JANIS GREY/GREY XS	2401505	JANIS NAVY/NAVY XS	42,77
S	2401496	JANIS GREY/GREY S	2401503	JANIS NAVY/NAVY S	
M	2401495	JANIS GREY/GREY M	2401502	JANIS NAVY/NAVY M	
L	2401494	JANIS GREY/GREY L	2401501	JANIS NAVY/NAVY L	
XL	2401497	JANIS GREY/GREY XL	2401504	JANIS NAVY/NAVY XL	
2XL	2401492	JANIS GREY/GREY 2XL	2401499	JANIS NAVY/NAVY 2XL	
3XL	2401493	JANIS GREY/GREY 3XL	2401500	JANIS NAVY/NAVY 3XL	

VENTUS. Chaqueta cortavientos básica poliester/elastano de doble capa



Chaqueta cortavientos básica con forro micropolar interior. Puño con cierre de velcro. Cierre frontal de cremallera. Dispone de tres bolsillos frontales con cierre cremallera.



1894NEGRO/S



1894MARINO/S

Talla/Color	Negro.		Azul marino.		€ / u.
	Ref.	Código	Ref.	Código	
S	908121	1894NEGRO/S	908127	1894MARINO/S	46,44
M	908122	1894NEGRO/M	908128	1894MARINO/M	
L	908123	1894NEGRO/L	908129	1894MARINO/L	
XL	908124	1894NEGRO/XL	908130	1894MARINO/XL	
XXL	908125	1894NEGRO/XXL	908131	1894MARINO/XXL	
3XL	908126	1894NEGRO/3XL	908132	1894MARINO/3XL	

HYMALAYA. Chaqueta polar 100% Poliester. Forrada nylon



Chaqueta polar forrada. Cierre con cremallera frontal. Dos bolsillos laterales con cremallera y uno interior. Puño elástico. Ajuste en cintura con cordón. Apertura para serigrafía.



890GRIS/S



890MARINO/S

Talla/Color	Gris.		Azul marino.		€ / u.
	Ref.	Código	Ref.	Código	
S	1000998	890GRIS/S	1001003	890MARINO/S	77,48
M	1000999	890GRIS/M	1001004	890MARINO/M	
L	1001000	890GRIS/L	1001005	890MARINO/L	
XL	1001001	890GRIS/XL	1001006	890MARINO/XL	
XXL	1001002	890GRIS/XXL	1001007	890MARINO/XXL	

PEGASUS. Chaqueta polar básica 100% poliéster



Chaqueta polar básica con cierre de cremallera frontal. Dispone de dos bolsillos laterales con cremallera. Puño elástico. Ajuste en cintura con cordón.

Talla/Color	Azul marino.		€ / u.
	Ref.	Código	
S	908111	1890MARINO/S	26,64
M	908112	1890MARINO/M	
L	908113	1890MARINO/L	
XL	908114	1890MARINO/XL	
XXL	908115	1890MARINO/XXL	
3XL	908116	1890MARINO/3XL	



Forro polar ORTIGARA



Forro polar con 4 bolsillos, capucha fija e inserciones elásticas para una mayor comodidad. Una prenda ligera y cálida al mismo tiempo. Composición: forro polar antipilling 100% poliéster 160 g/m2.



04807-060-S



04807-081-S

Talla/Color	Negro.		Gris antracita.		€ / u.
	Ref.	Código	Ref.	Código	
S	2401506	04807-060-S	2401511	04807-081-S	28,75
M	2401507	04807-060-M	2401512	04807-081-M	
L	2401508	04807-060-L	2401513	04807-081-L	
XL	2401509	04807-060-XL	2401514	04807-081-XL	
XXL	2401510	04807-060-XXL	2401515	04807-081-XXL	

Polar básico



Polar básico. Tejido microfibra. Cierre central con cremallera completa. Tapeta interna vuelta en la parte superior para evitar roces en barbilla. 3 bolsillos en vivo con cremallera. 2 bolsillos en el interior. Cuello alto. Puños con ribete para mejor ajustes. Regular fit.



BONE BLACK XS



BONE GREY XS



BONE NAVY XS



BONE RED XS



BONE WHITE XS

Talla/Color	Negro.		Gris.		Azul navy.		Rojo.		Blanco.		€ / u.
	Ref.	Código	Ref.	Código	Ref.	Código	Ref.	Código	Ref.	Código	
XS	2401524	BONE BLACK XS	2401533	BONE GREY XS	2401542	BONE NAVY XS	2401551	BONE RED XS	2401560	BONE WHITE XS	18,95
S	2401522	BONE BLACK S	2401531	BONE GREY S	2401540	BONE NAVY S	2401549	BONE RED S	2401558	BONE WHITE S	
M	2401521	BONE BLACK M	2401530	BONE GREY M	2401539	BONE NAVY M	2401548	BONE RED M	2401557	BONE WHITE M	
L	2401520	BONE BLACK L	2401529	BONE GREY L	2401538	BONE NAVY L	2401547	BONE RED L	2401556	BONE WHITE L	
XL	2401523	BONE BLACK XL	2401532	BONE GREY XL	2401541	BONE NAVY XL	2401550	BONE RED XL	2401559	BONE WHITE XL	
2XL	2401516	BONE BLACK 2XL	2401525	BONE GREY 2XL	2401534	BONE NAVY 2XL	2401543	BONE RED 2XL	2401552	BONE WHITE 2XL	
3XL	2401517	BONE BLACK 3XL	2401526	BONE GREY 3XL	2401535	BONE NAVY 3XL	2401544	BONE RED 3XL	2401553	BONE WHITE 3XL	
4XL	2401518	BONE BLACK 4XL	2401527	BONE GREY 4XL	2401536	BONE NAVY 4XL	2401545	BONE RED 4XL	2401554	BONE WHITE 4XL	
5XL	2401519	BONE BLACK 5XL	2401528	BONE GREY 5XL	2401537	BONE NAVY 5XL	2401546	BONE RED 5XL	2401555	BONE WHITE 5XL	

Forro polar ORTIGARA



Sudadera con media cremallera. Con puño y cintura elásticos. Tejido estabilizado para evitar encogimiento. Composición: 65% algodón, 35% poliéster. 280 g/m2.



Talla/Color	Gris.		€ / u.
	Ref.	Código	
XL	2401621	04820-080-XL	30,01
XXL	2401622	04820-080-XXL	
3XL	2401623	04820-080-3XL	

Chaqueta polar bicolor



Talla/Color	Negro/rojo.		Negro/naranja.		Negro/verde lima.		Negro/celeste.		€ / u.
	Ref.	Código	Ref.	Código	Ref.	Código	Ref.	Código	
XS	8004179	201504 0/12 XS	8004186	201504 0/16 XS	8004193	201504 0/25 XS	8004200	201504 0/5 XS	24,05
S	8004177	201504 0/12 S	8004184	201504 0/16 S	8004191	201504 0/25 S	8004198	201504 0/5 S	
M	8004176	201504 0/12 M	8004183	201504 0/16 M	8004190	201504 0/25 M	8004197	201504 0/5 M	
L	8004175	201504 0/12 L	8004182	201504 0/16 L	8004189	201504 0/25 L	8004196	201504 0/5 L	
XL	8004178	201504 0/12 XL	8004185	201504 0/16 XL	8004192	201504 0/25 XL	8004199	201504 0/5 XL	
XXL	8004180	201504 0/12 XXL	8004187	201504 0/16 XXL	8004194	201504 0/25 XXL	8004201	201504 0/5 XXL	
3XL	8004181	201504 0/12 3XL	8004188	201504 0/16 3XL	8004195	201504 0/25 3XL	8004202	201504 0/5 3XL	

Talla/Color	Azul navy/rojo.		Azul navy/naranja.		Azul navy/verde lima.		Azul navy/celeste.		€ / u.
	Ref.	Código	Ref.	Código	Ref.	Código	Ref.	Código	
XS	8004207	201504 61/12XS	8004214	201504 61/16XS	8004221	201504 61/25XS	8004228	201504 61/5 XS	24,05
S	8004205	201504 61/12S	8004212	201504 61/16S	8004219	201504 61/25S	8004226	201504 61/5 S	
M	8004204	201504 61/12M	8004211	201504 61/16M	8004218	201504 61/25M	8004225	201504 61/5 M	
L	8004203	201504 61/12L	8004210	201504 61/16L	8004217	201504 61/25L	8004224	201504 61/5 L	
XL	8004206	201504 61/12XL	8004213	201504 61/16XL	8004220	201504 61/25XL	8004227	201504 61/5 XL	
XXL	8004208	201504 61/12XXL	8004215	201504 61/16XXL	8004222	201504 61/25XXL	8004229	201504 61/5 XXL	
3XL	8004209	201504 61/123XL	8004216	201504 61/163XL	8004223	201504 61/253XL	8004230	201504 61/5 3XL	

Talla/Color	Gris/rojo.		Gris/naranja.		Gris/verde lima.		Gris/celeste.		€ / u.
	Ref.	Código	Ref.	Código	Ref.	Código	Ref.	Código	
XS	8004235	201504 8/12 XS	8004242	201504 8/16 XS	8004249	201504 8/25 XS	8004256	201504 8/5 XS	24,05
S	8004233	201504 8/12 S	8004240	201504 8/16 S	8004247	201504 8/25 S	8004254	201504 8/5 S	
M	8004232	201504 8/12 M	8004239	201504 8/16 M	8004246	201504 8/25 M	8004253	201504 8/5 M	
L	8004231	201504 8/12 L	8004238	201504 8/16 L	8004245	201504 8/25 L	8004252	201504 8/5 L	
XL	8004234	201504 8/12 XL	8004241	201504 8/16 XL	8004248	201504 8/25 XL	8004255	201504 8/5 XL	
XXL	8004236	201504 8/12 XXL	8004243	201504 8/16 XXL	8004250	201504 8/25 XXL	8004257	201504 8/5 XXL	
3XL	8004237	201504 8/12 3XL	8004244	201504 8/16 3XL	8004251	201504 8/25 3XL	8004258	201504 8/5 3XL	

07



Sudadera VERENA



Sudadera con media cremallera. Con puño y cintura elásticos. Tejido estabilizado para evitar encogimiento. Composición: 65% algodón, 35% poliéster. 280 g/m2.



04820-040-S

04820-060-S

04820-080-S

Talla/Color	Azul.		Negro.		Gris.		€ / u.
	Ref.	Código	Ref.	Código	Ref.	Código	
S	2401561	04820-040-S	2401567	04820-060-S	2401573	04820-080-S	30,01
M	2401562	04820-040-M	2401568	04820-060-M	2401574	04820-080-M	
L	2401563	04820-040-L	2401569	04820-060-L	2401575	04820-080-L	
XL	2401564	04820-040-XL	2401570	04820-060-XL			
XXL	2401565	04820-040-XXL	2401571	04820-060-XXL			
3XL	2401566	04820-040-3XL	2401572	04820-060-3XL			

Sudadera básica



Sudadera básica unisex. Cuello, puños y cinturilla de punto canalé con elastano. Costura plana doble en la sisa, puños, dobladillo, hombros y parte delantera del cuello para mayor resistencia.



LAND BLACK XS

LAND GREY XS

LAND NAVY XS

LAND RED XS

LAND WHITE XS

Talla/Color	Negro.		Gris.		Azul navy.		Rojo.		Blanco.		€ / u.
	Ref.	Código	Ref.	Código	Ref.	Código	Ref.	Código	Ref.	Código	
XS	2401584	LAND BLACK XS	2401593	LAND GREY XS	2401602	LAND NAVY XS	2401611	LAND RED XS	2401620	LAND WHITE XS	15,81
S	2401582	LAND BLACK S	2401591	LAND GREY S	2401600	LAND NAVY S	2401609	LAND RED S	2401618	LAND WHITE S	
M	2401581	LAND BLACK M	2401590	LAND GREY M	2401599	LAND NAVY M	2401608	LAND RED M	2401617	LAND WHITE M	
L	2401580	LAND BLACK L	2401589	LAND GREY L	2401598	LAND NAVY L	2401607	LAND RED L	2401616	LAND WHITE L	
XL	2401583	LAND BLACK XL	2401592	LAND GREY XL	2401601	LAND NAVY XL	2401610	LAND RED XL	2401619	LAND WHITE XL	
2XL	2401576	LAND BLACK 2XL	2401585	LAND GREY 2XL	2401594	LAND NAVY 2XL	2401603	LAND RED 2XL	2401612	LAND WHITE 2XL	
3XL	2401577	LAND BLACK 3XL	2401586	LAND GREY 3XL	2401595	LAND NAVY 3XL	2401604	LAND RED 3XL	2401613	LAND WHITE 3XL	
4XL	2401578	LAND BLACK 4XL	2401587	LAND GREY 4XL	2401596	LAND NAVY 4XL	2401605	LAND RED 4XL	2401614	LAND WHITE 4XL	
5XL	2401579	LAND BLACK 5XL	2401588	LAND GREY 5XL	2401597	LAND NAVY 5XL	2401606	LAND RED 5XL	2401615	LAND WHITE 5XL	

Chaqueta cortavientos acolchada de nylon®/poliéster



Chaqueta cortavientos acolchada con cierre frontal de cremallera. Dispone de dos bolsillos laterales con cierre de cremallera.

Talla/Color	Azul marino.		€ / u.
	Ref.	Código	
S	8001374	2894/S	68,03
M	8001375	2894/M	
L	8001376	2894/L	
XL	8001377	2894/XL	
XXL	8001378	2894/XXL	
3XL	8001379	2894/3XL	



Chaqueta JUST



Chaqueta en tejido softshell con 4 bolsillos en tejido particularmente suave y al mismo tiempo técnico. Dotado de inserciones reflectantes y con un práctico roller porta llaves.

Composición: softshell (poliéster/spandex) con membrana TPU impermeable w/p 8.000 - transpirable mvp 1.000.



04515N-040-L



04515N-060-L



04515N-070-L



04515N-080-L

Talla/Color	Azul.		Negro.		Rojo.		Gris.		€ / u.
	Ref.	Código	Ref.	Código	Ref.	Código	Ref.	Código	
XS			2401628	04515N-060-XS	2401635	04515N-070-XS	2401642	04515N-080-XS	57,02
S			2401629	04515N-060-S	2401636	04515N-070-S	2401643	04515N-080-S	
M			2401630	04515N-060-M	2401637	04515N-070-M	2401644	04515N-080-M	
L	2401624	04515N-040-L	2401631	04515N-060-L	2401638	04515N-070-L	2401645	04515N-080-L	
XL	2401625	04515N-040-XL	2401632	04515N-060-XL	2401639	04515N-070-XL	2401646	04515N-080-XL	
XXL	2401626	04515N-040-XXL	2401633	04515N-060-XXL	2401640	04515N-070-XXL	2401647	04515N-080-XXL	
3XL	2401627	04515N-040-3XL	2401634	04515N-060-3XL	2401641	04515N-070-3XL	2401648	04515N-080-3XL	

Chaqueta SPRINGER



Chaqueta stretch que cuenta con una increíble elasticidad gracias al innovador tejido que incorpora, convirtiéndola en una prenda muy confortable. La chaqueta cuenta con dos bolsillos externos, un bolsillo porta documentos en el pecho y dos bolsillos amplios interiores. Composición: Parte externa en 83% nylon y 17% spandex 340 g/m2. Relleno 140 g/m2



04529B-40-S



04529B-60-S



04529B-80-S

Talla/Color	Azul.		Negro.		Gris.		€ / u.
	Ref.	Código	Ref.	Código	Ref.	Código	
S	2401649	04529B-40-S	2401655	04529B-60-S	2401661	04529B-80-S	60,30
M	2401650	04529B-40-M	2401656	04529B-60-M	2401662	04529B-80-M	
L	2401651	04529B-40-L	2401657	04529B-60-L	2401663	04529B-80-L	
XL	2401652	04529B-40-XL	2401658	04529B-60-XL	2401664	04529B-80-XL	
XXL	2401653	04529B-40-XXL	2401659	04529B-60-XXL	2401665	04529B-80-XXL	
3XL	2401654	04529B-40-3XL	2401660	04529B-60-3XL	2401666	04529B-80-3XL	

07



Softshell

Chaqueta softshell cómoda y ligera, confeccionada con tejido elástico multicapa con membrana y forro interior de tejido polar. 2 bolsillos laterales con cremallera. 1 bolsillo en el pecho con cremallera. Cortaviento, transpirable y resistente al agua. Membrana impermeable. Cremallera central con protector de barbilla. Ajuste con velcro y tirador plástico en los puños.



CHITRA BLACK XS

CHITRA DARK GREEN XS

CHITRA GREY XS

CHITRA NAVY XS

Talla/Color	Negro.		Verde oscuro.		Gris.		Azul navy.		€ / u.
	Ref.	Código	Ref.	Código	Ref.	Código	Ref.	Código	
XS	2401672	CHITRA BLACK XS	2401679	CHITRA DARK GREEN XS	2401686	CHITRA GREY XS	2401693	CHITRA NAVY XS	54,55
S	2401670	CHITRA BLACK S	2401677	CHITRA DARK GREEN S	2401684	CHITRA GREY S	2401691	CHITRA NAVY S	
M	2401669	CHITRA BLACK M	2401676	CHITRA DARK GREEN M	2401683	CHITRA GREY M	2401690	CHITRA NAVY M	
L	2401668	CHITRA BLACK L	2401675	CHITRA DARK GREEN L	2401682	CHITRA GREY L	2401689	CHITRA NAVY L	
XL	2401671	CHITRA BLACK XL	2401678	CHITRA DARK GREEN XL	2401685	CHITRA GREY XL	2401692	CHITRA NAVY XL	
2XL	2401673	CHITRA BLACK XXL	2401680	CHITRA DARK GREEN XXL	2401687	CHITRA GREY XXL	2401694	CHITRA NAVY XXL	
3XL	2401667	CHITRA BLACK 3XL	2401674	CHITRA DARK GREEN 3XL	2401681	CHITRA GREY 3XL	2401688	CHITRA NAVY 3XL	

Talla/Color	Rojo.		Azul.		Blanco.		€ / u.
	Ref.	Código	Ref.	Código	Ref.	Código	
XS	2401700	CHITRA RED XS	2401707	CHITRA ROYAL BLUE XS	2401714	CHITRA WHITE XS	54,55
S	2401698	CHITRA RED S	2401705	CHITRA ROYAL BLUE S	2401712	CHITRA WHITE S	
M	2401697	CHITRA RED M	2401704	CHITRA ROYAL BLUE M	2401711	CHITRA WHITE M	
L	2401696	CHITRA RED L	2401703	CHITRA ROYAL BLUE L	2401710	CHITRA WHITE L	
XL	2401699	CHITRA RED XL	2401706	CHITRA ROYAL BLUE XL	2401713	CHITRA WHITE XL	
2XL	2401701	CHITRA RED XXL	2401708	CHITRA ROYAL BLUE XXL	2401715	CHITRA WHITE XXL	
3XL	2401695	CHITRA RED 3XL	2401702	CHITRA ROYAL BLUE 3XL	2401709	CHITRA WHITE 3XL	

Camiseta interior térmica TECNICA



ACTIVE PRO es un tejido inteligente de regulación térmica y evacuación del sudor que se adapta a las condiciones ambientales y garantiza un óptimo confort. Por su estructura sin costuras y gracias al diseño ergonómico de todas sus zonas estratégicas, la comodidad y la efectividad está garantizada.



Talla/Color	Azul marino.		€ / u.
	Ref.	Código	
S	21060023	740DN/S	49,27
M	21060024	740DN/M	
L	21060025	740DN/L	
XL	21060026	740DN/XL	

Camiseta interior térmica



Camiseta muy ligera y ajustable, Tejido doble en puños y cuello, Corte con mangas en ranglán que permite mayor libertad de movimientos, Embalaje individual para punto de venta [Camiseta del conjunto 730DN]



Talla/Color	Azul marino.		€ / u.
	Ref.	Código	
S	2401716	732DN/S	19,15
M	2401717	732DN/M	
L	2401718	732DN/L	
XL	2401719	732DN/XL	
XXL	2401720	732DN/XXL	

Pantalón anti-frío



Pantalón multibolsillos con refuerzo extra en la parte trasera (zona de mayor desgaste). Dispone de elásticos en los laterales para mayor ajuste. Cierre cremallera con botón. Apto para ciertos trabajos de soldadura.



Ref.	Código	Color	Talla	€ / u.	Ref.	Código	Color	Talla	€ / u.	Ref.	Código	Color	Talla	€ / u.
"Bergara" pantalón 100% algodón 280 grm.					Pantalón multibolsillos de tejido cortavientos de poliéster/spandex, repelente al agua y transpirable					"Snow" Pantalón frío multibolsillos de tejido cortavientos, repelente al agua y transpirable				
908181	839BL/XS		XS		1001141	984DN/S		S		908175	984B/S		S	
908182	839BL/S		S		1001142	984DN/M		M		908176	984B/M		M	
908183	839BL/M		M		1001143	984DN/L	Azul marino	L	73,79	908177	984B/L	Negro	L	73,79
908184	839BL/L	Azul marino	L	52,94	1001144	984DN/XL		XL		908178	984B/XL		XL	
908185	839BL/XL		XL		1001145	984DN/XXL		XXL		908179	984B/XXL		XXL	
908186	839BL/XXL		XXL		1001146	984DN/3XL		3XL		908180	984B/3XL		3XL	
908187	839BL/3XL		3XL											

Ropa para agua



Chaqueta con capucha externa fija. Cierre frontal con cremallera y botones a presión. Pantalón con goma elástica en la cintura.



Ref.	Código	Color	Talla	€ / u.	Ref.	Código	Color	Talla	€ / u.	Ref.	Código	Color	Talla	€ / u.
Traje de agua Poliuretano 100% s/soporte de Nylon. 0,38-0,42 mm. BE GREEN					Traje de agua nylon 100% sin soporte de PVC 0,18 mm. BE GREEN					Traje de agua nylon 100% sin soporte de PVC 0,18 mm. BE GREEN				
908167	804RHVERDE/M		L		908143	802RHAZUL/S		S		908155	802RHYEL/S		S	
908168	804RHVERDE/L	Verde	XL	84,75	908144	802RHAZUL/M		M		908156	802RHYEL/M		M	
908169	804RHVERDE/XL		XXL		908145	802RHAZUL/L		L		908157	802RHYEL/L	Amarillo	L	26,05
908170	804RHVERDE/XXL		XXL		908146	802RHAZUL/XL	Azul	XL	26,05	908158	802RHYEL/XL		XL	
Traje de agua Poliuretano 100% s/soporte de Nylon. 0,38-0,42 mm. BE GREEN					PVC 0,18 mm. BE GREEN					Traje de agua Poliuretano 100% sin soporte de nylon. 0,38-0,42 mm. BE GREEN				
908171	804RHYEL/M		M		908149	802RHVERDE/S		S		908161	804RHAZUL/S		S	
908172	804RHYEL/L	Amarillo	L	84,75	908150	802RHVERDE/M		M		908162	804RHAZUL/M		M	
908173	804RHYEL/XL		XL		908151	802RHVERDE/L		L		908163	804RHAZUL/L		L	
908174	804RHYEL/XXL		XXL		908152	802RHVERDE/XL	Verde	XL	26,05	908164	804RHAZUL/XL	Azul	XL	84,75
					908153	802RHVERDE/XXL		XXL		908165	804RHAZUL/XXL		XXL	
					908154	802RHVERDE/3XL		3XL		908166	804RHAZUL/3XL		3XL	



Cazadora acolchada con capucha interior poliéster. Certificada para lluvia.



Acolchada. Tejido impermeable. Capucha oculta en el interior del cuello. Puños ajustables con cinta de autocierre. Cierre frontal con cremallera y botones a presión. Dispone de 3 bolsillos delanteros con cierre de cremallera, dos frontales y uno en el pecho. Bolsillo interior. Certificada con la normativa EN343:2019: protección contra la lluvia.



Talla/Color	Gris.		€/ u.
	Ref.	Código	
S	21060197	2910/S	93,89
M	21060198	2910/M	
L	21060199	2910/L	
XL	21060200	2910/XL	
XXL	21060201	2910/XXL	
3XL	21060202	2910/3XL	

Ropa ignífuga y antiestática



988-CAIA/N 3738

988-PKIA/AE S

988-PIA/AE 3840

988-CIA/AE 4850



988-BIA/AE 4850

988-CAIAM 3738

988-PIAM 3840

988-CIAM 4850

988-BIAM 4850

Ref.	Código	Color	Talla	€/ u.	Ref.	Código	Color	Talla	€/ u.	Ref.	Código	Color	Talla	€/ u.		
Camisa ignífuga y antiestática azul marino algodón					Cazadora ignífuga y antiestática azul marino algodón					Pantalón ignífugo y antiestático						
1002916	988-CAIA/N 3738	Azul marino	37-38	39,04	1002937	988-CIA/AE 4850	Azul marino	48-50	41,47	1002957	988-PIAM 3840	Azul marino	38-40	55,04		
1002917	988-CAIA/N 3940		39-40		1002938	988-CIA/AE 5254		52-54		1002958	988-PIAM 4244		42-44			
1002918	988-CAIA/N 4142		41-42		1002939	988-CIA/AE 5658		56-58		1002959	988-PIAM 4648		46-48			
1002919	988-CAIA/N 4344		43-44		1002940	988-CIA/AE 6062		60-62		1002960	988-PIAM 5052		50-52			
1002920	988-CAIA/N 4546		45-46		1002941	988-CIA/AE 6466		64-66		1002961	988-PIAM 5456		54-56			
1002921	988-CAIA/N 4748		47-48		1002942	988-CIA/AE 6870		68-70		1002962	988-PIAM 5860		58-60			
1002922	988-CAIA/N 4950		49-50		Buzo ignífugo y antiestático azul marino algodón					1002963	988-PIAM 6264		62-64			
1002923	988-CAIA/N 5152		51-52		1002943	988-BIA/AE 4850		48-50		Cazadora ignífuga y antiestática						
Parka ignífuga y antiestática azul marino algodón					1002944	988-BIA/AE 5254		52-54		1002964	988-CIAM 4850		48-50		Azul marino	63,68
1002924	988-PKIA/AE S	S	1002945	988-BIA/AE 5658	56-58	64,26	1002965	988-CIAM 5254	52-54							
1002925	988-PKIA/AE M	M	1002946	988-BIA/AE 6062	60-62	1002966	988-CIAM 5658	56-58								
1002926	988-PKIA/AE L	L	1002947	988-BIA/AE 6466	64-66	1002967	988-CIAM 6062	60-62								
1002927	988-PKIA/AE XL	XL	1002948	988-BIA/AE 6870	68-70	1002968	988-CIAM 6466	64-66								
1002928	988-PKIA/AE XXL	XXL	Camisa ignífuga y antiestática					1002969	988-CIAM 6870	68-70						
1002929	988-PKIA/AE XXXL	XXXL	1002949	988-CAIAM 3738	37-38	Buzo ignífugo y antiestático										
Pantalón ignífugo y antiestático azul marino algodón					1002950	988-CAIAM 3940	39-40	1002970	988-BIAM 4850	48-50	Azul marino	101,12				
1002930	988-PIA/AE 3840	38-40	1002951	988-CAIAM 4142	41-42	46,46	1002971	988-BIAM 5254	52-54							
1002931	988-PIA/AE 4244	42-44	1002952	988-CAIAM 4344	43-44	1002972	988-BIAM 5658	56-58								
1002932	988-PIA/AE 4648	46-48	1002953	988-CAIAM 4546	45-46	1002973	988-BIAM 6062	60-62								
1002933	988-PIA/AE 5052	50-52	1002954	988-CAIAM 4748	47-48	1002974	988-BIAM 6466	64-66								
1002934	988-PIA/AE 5456	54-56	1002955	988-CAIAM 4950	49-50	1002975	988-BIAM 6870	68-70								
1002935	988-PIA/AE 5860	58-60	1002956	988-CAIAM 5152	51-52											
1002936	988-PIA/AE 6264	62-64														

07



Buzo ignífugo y antiestático

Buzo fabricado en Algodón 98% con tratamiento FR y 2% fibra antiestática. Dos bolsillos frontales con tapeta apesillada y cierre por velcro. Dos bolsillos posteriores con tapetas apesilladas y cierre por velcro. Dos bolsillos franceses. Elástico posterior en cintura. Cremallera FR. Cuello alto para mayor protección de radiaciones por soldadura. Tejido resistente a 50 ciclos de lavado a 60°C con secado al aire manteniendo las propiedades ignifugas de certificación. Gramaje 260 gr/m2. Color: azul marino. Tallas: S-M-L-XL-XXL-3XL Categoría CE: CAT III

Talla/Color	Azul marino.		€ / u.
	Ref.	Código	
S	8001668	WLR400-S	64,56
M	8001669	WLR400-M	
L	8001670	WLR400-L	
XL	8001671	WLR400-XL	
XXL	8001672	WLR400-XXL	
3XL	8001673	WLR400-3XL	



Camisa ignífuga y antiestática

Fibra algodón FR 98% y 2% fibra antiestática. Camisa de gran confort y diseño para soldadura o afines fabricado en Algodón 98% con tratamiento FR y 2% fibra antiestática. Dos bolsillos frontales con tapeta y cierre por botón. Elástico posterior. Cremallera FR. Tejido resistente a 50 ciclos de lavado a 60°C con secado al aire manteniendo las propiedades ignifugas de certificación. Gramaje 260 gr/m2. Color: azul marino. Composición: Fibra algodón FR y fibra antiestática 260 gr/m2 Tallas: S--M-L-XL-XXL-3XL Categoría CE: CAT II

Talla/Color	Azul marino.		€ / u.
	Ref.	Código	
S	8001674	WLR100-S	49,14
M	8001675	WLR100-M	
L	8001676	WLR100-L	
XL	8001677	WLR100-XL	
XXL	8001678	WLR100-XXL	
3XL	8001679	WLR100-3XL	



Chaqueta ignífuga y antiestática

Chaqueta de gran confort y diseño para soldadura o afines fabricado en Algodón 78% con tratamiento FR, fibra de poliéster 20% y fibra antiestática 2%. Dos bolsillos frontales con tapeta apesillada y cierre por velcro. Elástico posterior en cintura. Cuello alto para mayor protección de radiaciones por soldadura. Gramaje 290 gr/m2. Color: azul marino. Tallas: S--M-L-XL-XXL-3XL Categoría CE: CAT II

Talla/Color	Azul marino.		€ / u.
	Ref.	Código	
S	8001680	WLR300-S	48,22
M	8001681	WLR300-M	
L	8001682	WLR300-L	
XL	8001683	WLR300-XL	
XXL	8001684	WLR300-XXL	
3XL	8001685	WLR300-3XL	



Pantalon ignífugo y antiestático

Fibra algodón FR 98% y 2% fibra antiestática. Pantalón de gran confort y diseño para soldadura o afines fabricado en Algodón 98% con tratamiento FR y 2% fibra antiestática. Dos bolsillos posteriores con tapeta apesillada y cierre por velcro. Dos bolsillos tipo francés. Elástico posterior en cintura. Cremallera FR. Tejido resistente a 50 ciclos de lavado a 60°C con secado al aire manteniendo las propiedades ignifugas de certificación. Gramaje 260 gr/m2. Color: azul marino. Tallas: S--M-L-XL-XXL-3XL Categoría CE: CAT III

Talla/Color	Azul marino.		€ / u.
	Ref.	Código	
S	8001686	WLR200-S	38,89
M	8001687	WLR200-M	
L	8001688	WLR200-L	
XL	8001689	WLR200-XL	
XXL	8001690	WLR200-XXL	
3XL	8001691	WLR200-3XL	



Prenda protección desechable



7000109011



7000089661



7000089642



7100040087



7100198129



7000034772



7000034776

Ref.	Código	Color	Talla	€/ u.	Ref.	Código	Color	Talla	€/ u.
1000556	7100015978	Blanco	3XL	11,06	1000566	7100036529	Blanco y azul	XXL	12,46
1000536	7000089661	Blanco	S	8,90	1000569	7100198129	Blanco y azul	M	12,61
1000537	7000089662	Blanco	M	8,90	1000570	7100198241	Blanco y azul	L	12,61
1000538	7000089663	Blanco	L	8,90	1000571	7100198131	Blanco y azul	XL	12,61
1000539	7000089664	Blanco	XL	8,90	1000573	7100196882	Blanco y azul	3XL	12,61
1000540	7000089665	Blanco	XXL	8,90	1000575	7000034772	Blanco y rojo	M	17,28
1000541	7000089666	Blanco	3XL	8,90	1000585	7000034776	Blanco	S	3,90
1000542	7000089642	Blanco + Verde	S	8,00	1000586	7000089695	Blanco	S	3,90
1000543	7000034761	Blanco + Verde	M	8,00	1000587	7000034777	Blanco	L	3,90
1000544	7000034762	Blanco + Verde	L	8,00	1000588	7000089696	Blanco	XL	3,90
1000545	7000034763	Blanco + Verde	XL	8,00	1000589	7000089697	Blanco	XXL	3,90
1000546	7000034764	Blanco + Verde	XXL	8,00	1000590	7000089698	Blanco	3XL	3,90
1000548	7000109011	Blanco + Azul	M	10,64	1000591	7000089699	Blanco	4XL	3,90
1000549	7000109012	Blanco + Azul	L	10,64	1000596	7000089708	Blanco	S	7,04
1000550	7000109013	Blanco + Azul	XL	10,64	1000597	7000089709	Blanco	M	7,04
1000553	7100015949	Azul + Blanco	M	11,06	1000598	7000089710	Blanco	L	7,04
1000554	7100016012	Azul + Blanco	L	11,06	1000612	7000089711	Blanco	XL	7,04
1000567	7100041597	Blanco y azul	3XL	249,12	1000613	7000089712	Blanco	XXL	7,04
1000563	7100040087	Blanco y azul	M	12,46	1000614	7000089713	Blanco	3XL	7,04
1000564	7100040416	Blanco y azul	L	12,46					

Gama desechable accesorios



7000088638



7000089721



7000089720



7000089715

Ref.	Código	Color	Talla	€/ u.
1002774	7000088638	Blanco	Única	4,85
1016100	7000089721	Azul	Única	0,31
1016101	7000089720	Blanco	Única	0,61
1016102	7000089715	Blanco	Única	1,04



Tirantes de alta visibilidad certificados con la EN ISO 20471



Bandas reflectantes de alta visibilidad. Bolsa individual para punto de venta

Talla/Color	Naranja flúor.		€ / u.
	Ref.	Código	
M	2401727	HVTORA/M	6,40
XL	2401728	HVTORA/XL	



Chaleco alta visibilidad reversible. Bandas 3M™



Bandas reflectantes de 3M® Scotchlite™. Cierre frontal con cremallera. Dispone de dos bolsillos interiores.



Talla/Color	Amarillo flúor.		€ / u.
	Ref.	Código	
S	1001202	HV708/S	59,22
M	1001203	HV708/M	
L	21060027	HV708/L	
XL	1001204	HV708/XL	
XXL	1001205	HV708/XXL	



Chaleco multibolsillos de tejido poliéster Oxford/PU



Bandas reflectantes de 3M® Scotchlite™. Cierre frontal con cremallera. Dispone de dos bolsillos interiores.

Talla/Color	Amarillo flúor/azul marino.		€ / u.
	Ref.	Código	
S	1001280	HV717/S	72,67
M	1001281	HV717/M	
L	1001282	HV717/L	
XL	1001283	HV717/XL	
XXL	1001284	HV717/XXL	



Chaleco alta visibilidad



Talla/Color	Amarillo flúor.		€ / u.
	Ref.	Código	
L	1001364	288-VMFNL	37,12
M	1001365	288-VMFNM	
XL	1001366	288-VMFNXL	
XXL	1001367	288-VMFNXXL	



Traje de agua alta visibilidad



Cierre frontal con cremallera y botones a presión. Dos bolsillos en la parte frontal con cierre de velcro. Capucha fija oculta con cierre de velcro. Pantalones con cintura elástica y cordón ajustable.

Talla/Color	Amarillo flúor.		€ / u.
	Ref.	Código	
S	1001206	HV750/S	114,71
M	1001207	HV750/M	
L	1001208	HV750/L	
XL	1001209	HV750/XL	
XXL	1001210	HV750/XXL	



Pantalón de agua con costuras termosoldadas alta visibilidad



Pantalones con cintura elástica y cordón ajustable

Talla/Color	Amarillo flúor.		€/ u.
	Ref.	Código	
S	2401721	HV750P/S	46,25
M	2401722	HV750P/M	
L	2401723	HV750P/L	
XL	2401724	HV750P/XL	
XXL	2401725	HV750P/XXL	
3XL	2401726	HV750P/3XL	



Pantalón bicolor de alta visibilidad



157 170 S



157 240 S



157 12/20 M



157 18/20 S



157 0/20 S

Talla/Color	Verde hierba/amarillo flúor.		Gris/naranja flúor.		Rojo/naranja flúor.		Granate/amarillo flúor.		Negro/amarillo flúor.		€/ u.
	Ref.	Código	Ref.	Código	Ref.	Código	Ref.	Código	Ref.	Código	
S	8003452	157 170 S	8003458	157 240 S	8003464	157 12/20 S	8003470	157 18/20 S	8003476	157 0/20 S	20,55
M	8003453	157 170 M	8003459	157 240 M	8003465	157 12/20 M	8003471	157 18/20 M	8003477	157 0/20 M	
L	8003454	157 170 L	8003460	157 240 L	8003466	157 12/20 L	8003472	157 18/20 L	8003478	157 0/20 L	
XL	8003455	157 170 XL	8003461	157 240 XL	8003467	157 12/20 XL	8003473	157 18/20 XL	8003479	157 0/20 XL	
XXL	8003456	157 170 XXL	8003462	157 240 XXL	8003468	157 12/20 XXL	8003474	157 18/20 XXL	8003480	157 0/20 XXL	
3XL	8003457	157 170 3XL	8003463	157 240 3XL	8003469	157 12/20 3XL	8003475	157 18/20 3XL	8003481	157 0/20 3XL	

Pantalón stretch bicolor de alta visibilidad



303002S 190 S



303002S 61/19 S

Talla/Color	Azul navy/amarillo flúor.		Azul navy/naranja flúor.		€/ u.
	Ref.	Código	Ref.	Código	
S	8003494	303002S 190 S	8003500	303002S 61/19 S	33,53
M	8003495	303002S 190 M	8003501	303002S 61/19 M	
L	8003496	303002S 190 L	8003502	303002S 61/19 L	
XL	8003497	303002S 190 XL	8003503	303002S 61/19 XL	
XXL	8003498	303002S 190 XXL	8003504	303002S 61/19 XXL	
3XL	8003499	303002S 190 3XL	8003505	303002S 61/19 3XL	



Pantalón largo multibolsillos 77% poliéster/20% algodón/3% Spandex de 245 grs. con bandas



Pantalón multibolsillos bicolor de alta visibilidad con bandas reflectantes. Cierre con cremallera y botón. Cintura con elásticos laterales. Hebillas en cintura. En la parte superior dispone de dos bolsillos frontales abiertos y dos traseros con cierre de gancho y bucle. Bolsillos laterales en las piernas con cierre de gancho y bucle.



Talla/Color	Amarillo flúor/azul marino.		€ / u.
	Ref.	Código	
XS	21060190	HV745/XS	64,14
S	21060191	HV745/S	
M	21060192	HV745/M	
L	21060193	HV745/L	
XL	21060194	HV745/XL	
XXL	21060195	HV745/XXL	
3XL	21060196	HV745/3XL	

Pantalón técnico multibolsillos forrado alta visibilidad



Cierre frontal de cremallera y botón a presión, Elásticos en los laterales de la cintura y cinturón elástico ajustable, Apertura lateral en el bajo ajustable, Certificado a frío según normativa EN14058:2017



Talla/Color	Negro/amarillo flúor.		€ / u.
	Ref.	Código	
S	2401729	HV984B/S	79,25
M	2401730	HV984B/M	
L	2401731	HV984B/L	
XL	2401732	HV984B/XL	
XXL	2401733	HV984B/XXL	
3XL	2401734	HV984B/3XL	
S	2401735	HV984DN/S	
M	2401736	HV984DN/M	
L	2401737	HV984DN/L	
XL	2401738	HV984DN/XL	
XXL	2401739	HV984DN/XXL	
3XL	2401740	HV984DN/3XL	

Pantalón multibolsillos alta visibilidad



Pantalón multibolsillos de alta visibilidad combinados. Disponen de dos bandas reflectantes en color gris/plata que rodean las perneras. Las bandas llevan doble costura lo cuál las dota de un extra de sujeción al tejido de los Pantalón. El modelo dispone de dos bolsillos laterales situados en cada una de las perneras, con cierre por tapeta y velcro. Dispone también de bolsillo porta monedas, dos bolsillos tipo francés y dos bolsillos traseros con cierre por tapeta y velcro.



DOVER ORANGE/NAVY 2XL



DOVER YELLOW/GREEN 2XL



DOVER YELLOW/GREY 2XL



DOVER YELLOW/NAVY 2XL

Talla/Color	Naranja/Azul navy.		Amarillo/Verde.		Amarillo/Gris.		Amarillo/Azul navy.		€ / u.
	Ref.	Código	Ref.	Código	Ref.	Código	Ref.	Código	
XS	2401748	DOVER ORANGE/NAVY XS	2401756	DOVER YELLOW/GREEN XS	2401764	DOVER YELLOW/GREY XS	2401772	DOVER YELLOW/NAVY XS	21,71
S	2401746	DOVER ORANGE/NAVY S	2401754	DOVER YELLOW/GREEN S	2401762	DOVER YELLOW/GREY S	2401770	DOVER YELLOW/NAVY S	
M	2401745	DOVER ORANGE/NAVY M	2401753	DOVER YELLOW/GREEN M	2401761	DOVER YELLOW/GREY M	2401769	DOVER YELLOW/NAVY M	
L	2401744	DOVER ORANGE/NAVY L	2401752	DOVER YELLOW/GREEN L	2401760	DOVER YELLOW/GREY L	2401768	DOVER YELLOW/NAVY L	
XL	2401747	DOVER ORANGE/NAVY XL	2401755	DOVER YELLOW/GREEN XL	2401763	DOVER YELLOW/GREY XL	2401771	DOVER YELLOW/NAVY XL	
XXL	2401741	DOVER ORANGE/NAVY 2XL	2401749	DOVER YELLOW/GREEN 2XL	2401757	DOVER YELLOW/GREY 2XL	2401765	DOVER YELLOW/NAVY 2XL	
3XL	2401742	DOVER ORANGE/NAVY 3XL	2401750	DOVER YELLOW/GREEN 3XL	2401758	DOVER YELLOW/GREY 3XL	2401766	DOVER YELLOW/NAVY 3XL	
4XL	2401743	DOVER ORANGE/NAVY 4XL	2401751	DOVER YELLOW/GREEN 4XL	2401759	DOVER YELLOW/GREY 4XL	2401767	DOVER YELLOW/NAVY 4XL	

Pantalón multibolsillos bicolor de alta visibilidad



Pantalón multibolsillos con bandas reflectantes. Dispone de dos bolsillos superiores, dos traseros con velcro y tapeta y uno lateral. Cierre de cremallera y botón a presión. Cintura con elásticos laterales. Hebillas en cintura.



Ref.	Código	Color	Talla	€ / u.	Ref.	Código	Color	Talla	€ / u.	Ref.	Código	Color	Talla	€ / u.
KRETA Pantalón bicolor marino con banda amarilla de alta visibilidad					ITAKA Pantalón bicolor verde con banda amarilla de alta visibilidad					"Karelia" Pantalón bicolor marino con banda naranja de alta visibilidad				
1001231	HV810/XS	Azul marino/ amarillo flúor	XS	41,39	1001245	HV814/XS	Verde/ amarillo flúor	XS	44,72	908188	HV820/XS	Azul marino/ naranja flúor	XS	43,43
1001232	HV810/S		S		1001246	HV814/S		S		908189	HV820/S		S	
1001233	HV810/M		M		1001247	HV814/M		M		908190	HV820/M		M	
1001234	HV810/L		L		1001248	HV814/L		L		908191	HV820/L		L	
1001235	HV810/XL		XL		1001249	HV814/XL		XL		908192	HV820/XL		XL	
1001236	HV810/XXL		XXL		1001250	HV814/XXL		XXL		908193	HV820/XXL		XXL	
1001237	HV810/3XL	3XL	1001251	HV814/3XL	3XL	908194	HV820/3XL	3XL						
HYDRA Pantalón bicolor azulina con banda amarilla de alta visibilidad					KIOTO Pantalón bicolor gris con banda amarilla de alta visibilidad					Pantalón amarillo/marino alta visibilidad de poliéster/algodón de 230 grs. Con bandas reflectantes				
1001238	HV812/XS	Azulina/ amarillo flúor	XS	38,34	1001252	HV816/XS	Gris/ amarillo flúor	XS	42,47	908005	HV748BC/XS	Azul marino/ naranja flúor	XS	46,79
1001239	HV812/S		S		1001253	HV816/S		S		908006	HV748BC/S		S	
1001240	HV812/M		M		1001254	HV816/M		M		908007	HV748BC/M		M	
1001241	HV812/L		L		1001255	HV816/L		L		908008	HV748BC/L		L	
1001242	HV812/XL		XL		1001256	HV816/XL		XL		1001265	HV748BC/XL		XL	
1001243	HV812/XXL		XXL		1001257	HV816/XXL		XXL		908009	HV748BC/XXL		XXL	
1001244	HV812/3XL	3XL	1001258	HV816/3XL	3XL	908010	HV748BC/3XL	3XL						

Camiseta alta visibilidad



Camiseta de manga corta con bandas reflectantes. Bolsillo en el pecho.



Talla/Color	Amarillo flúor/azul marino.		€ / u.
	Ref.	Código	
S	1001286	HV721BCAZUL/S	20,58
M	1001287	HV721BCAZUL/M	
L	1001288	HV721BCAZUL/L	
XL	1001289	HV721BCAZUL/XL	
XXL	1001290	HV721BCAZUL/XXL	
3XL	1001291	HV721BCAZUL/3XL	

Talla/Color	Naranja flúor/azul marino.		€ / u.
	Ref.	Código	
S	908011	HV731BCAZUL/S	23,49
M	908012	HV731BCAZUL/M	
L	908013	HV731BCAZUL/L	
XL	908014	HV731BCAZUL/XL	
XXL	908015	HV731BCAZUL/XXL	
3XL	908016	HV731BCAZUL/3XL	

Camiseta técnica bicolor manga corta de alta visibilidad



305506 210 S



305506 70 S

Talla/Color	Amarillo flúor/azul navy.		Naranja flúor/azul navy.		€ / u.
	Ref.	Código	Ref.	Código	
XS			8003512	305506 70 S	
S	8003506	305506 210 S	8003513	305506 70 M	
M	8003507	305506 210 M	8003514	305506 70 L	
L	8003508	305506 210 L	8003515	305506 70 XL	13,97
XL	8003509	305506 210 XL	8003516	305506 70 XXL	
XXL	8003510	305506 210 XXL	8003517	305506 70 3XL	
3XL	8003511	305506 210 3XL			

Camiseta técnica de alta visibilidad



305505 19 S



305505 20 S

Talla/Color	Naranja flúor.		Amarillo flúor.		€ / u.
	Ref.	Código	Ref.	Código	
S	8003518	305505 19 S	8003524	305505 20 S	
M	8003519	305505 19 M	8003525	305505 20 M	
L	8003520	305505 19 L	8003526	305505 20 L	14,70
XL	8003521	305505 19 XL	8003527	305505 20 XL	
XXL	8003522	305505 19 XXL	8003528	305505 20 XXL	
3XL	8003523	305505 19 3XL	8003529	305505 20 3XL	

Polo bicolor alta visibilidad



Polo de manga corta con bandas reflectantes. Estilo piqué con tres botones y bolsillo en el pecho.



HV730BCAZUL/S



HV720BCAZUL/S

Talla/Color	Naranja flúor/azul marino.		€ / u.
	Ref.	Código	
S	1001225	HV730BCAZUL/S	
M	1001226	HV730BCAZUL/M	
L	1001227	HV730BCAZUL/L	
XL	1001228	HV730BCAZUL/XL	22,23
XXL	1001229	HV730BCAZUL/XXL	
3XL	1001230	HV730BCAZUL/3XL	

Talla/Color	Azul marino/amarillo.		€ / u.
	Ref.	Código	
S	1001211	HV720BCAZUL/S	
M	1001212	HV720BCAZUL/M	
L	1001213	HV720BCAZUL/L	
XL	1001214	HV720BCAZUL/XL	20,63
XXL	1001215	HV720BCAZUL/XXL	
3XL	1001216	HV720BCAZUL/3XL	

Polo alta visibilidad



1288-POLFNNL

Talla/Color	Naranja flúor.		Amarillo flúor.		€/ u.
	Ref.	Código	Ref.	Código	
S	1001430	1288-POLFNNNS	1001436	1288-POLFNNYS	13,38
M	1001429	1288-POLFNNM	1001435	1288-POLFNNYM	
L	1001428	1288-POLFNNL	1001434	1288-POLFNNYL	
XL	1001431	1288-POLFNNXL	1001437	1288-POLFNNYXL	
XXL	1001432	1288-POLFNNXXL	1001438	1288-POLFNNYXXL	
3XXL	1001433	1288-POLFNNXXXL	1001439	1288-POLFNNYXXXL	

Polo bicolor manga corta de alta visibilidad



173 180 S



173 19/8 S



173 20/12 S



173 20/18 S



173 20/0 S

Talla/Color	Amarillo flúor/verde hierba.		Naranja flúor/gris.		Amarillo flúor/rojo.		Amarillo flúor/granate.		Amarillo flúor/negro.		€/ u.
	Ref.	Código	Ref.	Código	Ref.	Código	Ref.	Código	Ref.	Código	
S	8003422	173 180 S	8003428	173 19/8 S	8003434	173 20/12 S	8003440	173 20/18 S	8003446	173 20/0 S	11,61
M	8003423	173 180 M	8003429	173 19/8 M	8003435	173 20/12 M	8003441	173 20/18 M	8003447	173 20/0 M	
L	8003424	173 180 L	8003430	173 19/8 L	8003436	173 20/12 L	8003442	173 20/18 L	8003448	173 20/0 L	
XL	8003425	173 180 XL	8003431	173 19/8 XL	8003437	173 20/12 XL	8003443	173 20/18 XL	8003449	173 20/0 XL	
XXL	8003426	173 180 XXL	8003432	173 19/8 XXL	8003438	173 20/12 XXL	8003444	173 20/18 XXL	8003450	173 20/0 XXL	
3XL	8003427	173 180 3XL	8003433	173 19/8 3XL	8003439	173 20/12 3XL	8003445	173 20/18 3XL	8003451	173 20/0 3XL	

Polo bicolor manga corta de alta visibilidad



Polo de manga corta de alta visibilidad combinado confeccionado con tejido técnico bird-eye que facilita la transpiración y dota a la prenda de unas características funcionales idóneas para la realización de cualquier trabajo bajo condiciones de calor medias/altas. La prenda dispone de tejido de malla en las axilas lo cual ayuda a la evaporación rápida del sudor. Dispone de 3 botones de plástico en el cuello en color de contraste y un bolsillo en el pecho con cierre por velcro. El cuello está confeccionado en tejido de canalé en el mismo color de contraste que la parte baja de la prenda. Cuenta con 2 bandas reflectantes de color gris/plata que rodean el torso.



ROCK ORANGE/NAVY 2XL



ROCK YELLOW/GREEN 2XL



ROCK YELLOW/GREY 2XL



ROCK YELLOW/NAVY 2XL

Talla/Color	Naranja/Azul navy.		Amarillo/Verde.		Amarillo/Gris.		Amarillo/Azul navy.		€/ u.
	Ref.	Código	Ref.	Código	Ref.	Código	Ref.	Código	
XS	2401781	ROCK ORANGE/NAVY XS	2401790	ROCK YELLOW/GREEN XS	2401799	ROCK YELLOW/GREY XS	2401808	ROCK YELLOW/NAVY XS	11,18
S	2401779	ROCK ORANGE/NAVY S	2401788	ROCK YELLOW/GREEN S	2401797	ROCK YELLOW/GREY S	2401806	ROCK YELLOW/NAVY S	
M	2401778	ROCK ORANGE/NAVY M	2401787	ROCK YELLOW/GREEN M	2401796	ROCK YELLOW/GREY M	2401805	ROCK YELLOW/NAVY M	
L	2401777	ROCK ORANGE/NAVY L	2401786	ROCK YELLOW/GREEN L	2401795	ROCK YELLOW/GREY L	2401804	ROCK YELLOW/NAVY L	
XL	2401780	ROCK ORANGE/NAVY XL	2401789	ROCK YELLOW/GREEN XL	2401798	ROCK YELLOW/GREY XL	2401807	ROCK YELLOW/NAVY XL	
XXL	2401773	ROCK ORANGE/NAVY 2XL	2401782	ROCK YELLOW/GREEN 2XL	2401791	ROCK YELLOW/GREY 2XL	2401800	ROCK YELLOW/NAVY 2XL	
3XL	2401774	ROCK ORANGE/NAVY 3XL	2401783	ROCK YELLOW/GREEN 3XL	2401792	ROCK YELLOW/GREY 3XL	2401801	ROCK YELLOW/NAVY 3XL	
4XL	2401775	ROCK ORANGE/NAVY 4XL	2401784	ROCK YELLOW/GREEN 4XL	2401793	ROCK YELLOW/GREY 4XL	2401802	ROCK YELLOW/NAVY 4XL	
5XL	2401776	ROCK ORANGE/NAVY 5XL	2401785	ROCK YELLOW/GREEN 5XL	2401794	ROCK YELLOW/GREY 5XL	2401803	ROCK YELLOW/NAVY 5XL	



07

Polo bicolor manga larga de alta visibilidad



175 180 M



175 19/8 XS



175 20/12 XS



175 20/18 XS



175 20/0 XS

Talla/Color	Amarillo flúor/verde hierba.		Naranja flúor/gris.		Amarillo flúor/rojo.		Amarillo flúor/granate.		Amarillo flúor/negro.		€/ u.
	Ref.	Código	Ref.	Código	Ref.	Código	Ref.	Código	Ref.	Código	
XS			8003394	175 19/8 XS	8003401	175 20/12 XS	8003408	175 20/18 XS	8003415	175 20/0 XS	
S	8003388	175 180 S	8003395	175 19/8 S	8003402	175 20/12 S	8003409	175 20/18 S	8003416	175 20/0 S	
M	8003389	175 180 M	8003396	175 19/8 M	8003403	175 20/12 M	8003410	175 20/18 M	8003417	175 20/0 M	
L	8003390	175 180 L	8003397	175 19/8 L	8003404	175 20/12 L	8003411	175 20/18 L	8003418	175 20/0 L	16,98
XL	8003391	175 180 XL	8003398	175 19/8 XL	8003405	175 20/12 XL	8003412	175 20/18 XL	8003419	175 20/0 XL	
XXL	8003392	175 180 XXL	8003399	175 19/8 XXL	8003406	175 20/12 XXL	8003413	175 20/18 XXL	8003420	175 20/0 XXL	
3XL	8003393	175 180 3XL	8003400	175 19/8 3XL	8003407	175 20/12 3XL	8003414	175 20/18 3XL	8003421	175 20/0 3XL	

Polo bicolor manga larga de alta visibilidad.



Polo de manga larga de alta visibilidad combinado confeccionado con tejido técnico bird-eye que facilita la transpiración y dota a la prenda de unas características funcionales idóneas para la realización de cualquier trabajo bajo condiciones de calor medias/altas. La prenda dispone de tejido de malla en las axilas lo cual ayuda a la evaporación rápida del sudor. Dispone de 3 botones de plástico en el cuello en color de contraste y un bosillo en el pecho con cierre por velcro. El cuello está confeccionado en tejido de canalé en el mismo color de contraste que la parte baja de la prenda. Cuenta con 2 bandas reflectantes de color gris/plata que rodean el torso.



OCEAN ORANGE/NAVY 2XL



OCEAN YELLOW/GREEN 2XL



OCEAN YELLOW/GREY 2XL



OCEAN YELLOW/NAVY 2XL

Talla/Color	Naranja/Azul navy.		Amarillo/Verde.		Amarillo/Gris.		Amarillo/Azul navy.		€/ u.
	Ref.	Código	Ref.	Código	Ref.	Código	Ref.	Código	
XS			2401825	OCEAN YELLOW/GREEN XS					
S	2401815	OCEAN ORANGE/NAVY S	2401823	OCEAN YELLOW/GREEN S	2401832	OCEAN YELLOW/GREY S	2401840	OCEAN YELLOW/NAVY S	
M	2401814	OCEAN ORANGE/NAVY M	2401822	OCEAN YELLOW/GREEN M	2401831	OCEAN YELLOW/GREY M	2401839	OCEAN YELLOW/NAVY M	
L	2401813	OCEAN ORANGE/NAVY L	2401821	OCEAN YELLOW/GREEN L	2401830	OCEAN YELLOW/GREY L	2401838	OCEAN YELLOW/NAVY L	
XL	2401816	OCEAN ORANGE/NAVY XL	2401824	OCEAN YELLOW/GREEN XL	2401833	OCEAN YELLOW/GREY XL	2401841	OCEAN YELLOW/NAVY XL	13,65
XXL	2401809	OCEAN ORANGE/NAVY 2XL	2401817	OCEAN YELLOW/GREEN 2XL	2401826	OCEAN YELLOW/GREY 2XL	2401834	OCEAN YELLOW/NAVY 2XL	
3XL	2401810	OCEAN ORANGE/NAVY 3XL	2401818	OCEAN YELLOW/GREEN 3XL	2401827	OCEAN YELLOW/GREY 3XL	2401835	OCEAN YELLOW/NAVY 3XL	
4XL	2401811	OCEAN ORANGE/NAVY 4XL	2401819	OCEAN YELLOW/GREEN 4XL	2401828	OCEAN YELLOW/GREY 4XL	2401836	OCEAN YELLOW/NAVY 4XL	
5XL	2401812	OCEAN ORANGE/NAVY 5XL	2401820	OCEAN YELLOW/GREEN 5XL	2401829	OCEAN YELLOW/GREY 5XL	2401837	OCEAN YELLOW/NAVY 5XL	

Chaqueta de alta visibilidad



Bandas reflectantes. Cierre de cremallera y tapeta con botones a presión. Dos bolsillos superiores, dos laterales abiertos y dos interiores con cierre velcro. Puños elásticos y ajuste en cintura.

Talla/Color	Amarillo flúor/azul marino.		€/ u.
	Ref.	Código	
S	1001259	HV746BC/S	
M	1001260	HV746BC/M	
L	1001261	HV746BC/L	60,94
XL	1001262	HV746BC/XL	
XXL	1001263	HV746BC/XXL	
3XL	1001264	HV746BC/3XL	



Sudadera bicolor con cremallera alta visibilidad



305701 19/61 S



305701 20/61 S



305701 20/2 L



305701 20/8 L

Talla/Color	Naranja flúor/azul navy.		Amarillo flúor/azul navy.		Amarillo flúor/verde.		Amarillo flúor/gris.		€/ u.
	Ref.	Código	Ref.	Código	Ref.	Código	Ref.	Código	
S	8003530	305701 19/61 S	8003536	305701 20/61 S	20021405	305701 20/2 S	20021411	305701 20/8 S	27,83
M	8003531	305701 19/61 M	8003537	305701 20/61 M	20021404	305701 20/2 M	20021410	305701 20/8 M	
L	8003532	305701 19/61 L	8003538	305701 20/61 L	20021403	305701 20/2 L	20021409	305701 20/8 L	
XL	8003533	305701 19/61 XL	8003539	305701 20/61 XL	20021406	305701 20/2 XL	20021412	305701 20/8 XL	
XXL	8003534	305701 19/61 XXL	8003540	305701 20/61 XXL	20021407	305701 20/2 XXL	20021413	305701 20/8 XXL	
3XL	8003535	305701 19/61 3XL	8003541	305701 20/61 3XL	20021408	305701 20/2 3XL	20021414	305701 20/8 3XL	

Cazadora bicolor de alta visibilidad



161 70 S



161 210 S

Talla/Color	Amarillo flúor/azul marino.		Naranja flúor/azul marino.		€/ u.
	Ref.	Código	Ref.	Código	
S	8003329	161 70 S	8003335	161 210 S	57,58
M	8003330	161 70 M	8003336	161 210 M	
L	8003331	161 70 L	8003337	161 210 L	
XL	8003332	161 70 XL	8003338	161 210 XL	
XXL	8003333	161 70 XXL	8003339	161 210 XXL	
3XL	8003334	161 70 3XL	8003340	161 210 3XL	

Cazadora soft shell alta visibilidad



306001 70 S



306001 210 S

Talla/Color	Amarillo flúor/azul marino.		Naranja flúor/azul marino.		€/ u.
	Ref.	Código	Ref.	Código	
S	8003341	306001 70 S	8003347	306001 210 S	68,98
M	8003342	306001 70 M	8003348	306001 210 M	
L	8003343	306001 70 L	8003349	306001 210 L	
XL	8003344	306001 70 XL	8003350	306001 210 XL	
XXL	8003345	306001 70 XXL	8003351	306001 210 XXL	
3XL	8003346	306001 70 3XL	8003352	306001 210 3XL	

Cazadora alta visibilidad



161 20/2 L



161 20/8 L

Talla/Color	Amarillo flúor/verde.		Amarillo flúor/gris.		Amarillo flúor/azul marino.		€ / u.
	Ref.	Código	Ref.	Código	Ref.	Código	
S	20020101	161 20/2 S	20020109	161 20/8 S	1002641	288-CSFY/A S	57,58
M	20020100	161 20/2 M	20020108	161 20/8 M	1002642	288-CSFY/A M	
L	20020099	161 20/2 L	20020107	161 20/8 L	1002643	288-CSFY/A L	
XL	20020102	161 20/2 XL	20020110	161 20/8 XL	1002644	288-CSFY/A XL	
XXL	20020103	161 20/2 XXL	20020111	161 20/8 XXL	1002645	288-CSFY/A XXL	
3XL	20020104	161 20/2 3XL	20020112	161 20/8 3XL	1002646	288-CSFY/A XXXL	

Cazadora alta visibilidad 3x1



Bandas reflectantes 3M® Scotchlite™. Cierre de cremallera. Tres bolsillos exteriores y uno interior. Puño elástico. Esta prenda ha sido certificada como chaleco de alta visibilidad, si se utiliza con mangas deja de ser un equipo de protección de alta visibilidad ya que deja de asegurar la protección total del usuario.



HV709/S



HV710/S

Talla/Color	Amarillo flúor/azul marino.		Naranja flúor/azul marino.		€ / u.
	Ref.	Código	Ref.	Código	
S	1012854	HV709/S	1012859	HV710/S	99,96
M	1012855	HV709/M	1012860	HV710/M	
L	1012856	HV709/L	1012861	HV710/L	
XL	1012857	HV709/XL	1012862	HV710/XL	
XXL	1012858	HV709/XXL			
3XL					

Cazadora alta visibilidad



Talla/Color	Amarillo flúor/azul marino.		€ / u.
	Ref.	Código	
S	1002910	288-PKFAMIXS	63,87
M	1002911	288-PKFAMIXM	
L	1002912	288-PKFAMIXL	
XL	1002913	288-PKFAMIXXL	
XXL	1002914	288-PKFAMIXXXL	
3XL	1002915	288-PKFAMIXXXXL	



07

Chaqueta cortavientos 100% poliéster con membrana de PU termoplástico y forro polar. Bandas reflectantes



Diseño moderno. Cierre frontal con cremallera y tapeta con cierre velcro. Dos bolsillos laterales y uno en el pecho con cierre de cremallera. Puño elástico de Lycra® para mayor ajuste en la muñeca. Forro polar interior. Color negro en las zonas de mayor suciedad. Certificado para ENISO20471:2013+AI:2016.

Talla/Color	Amarillo flúor/negro.		€/ u.
	Ref.	Código	
S	21060203	HV9910/S	65,97
M	21060204	HV9910/M	
L	21060205	HV9910/L	
XL	21060206	HV9910/XL	
XXL	21060207	HV9910/XXL	
3XL	21060208	HV9910/3XL	



Chaqueta polar bicolor de alta visibilidad



183 180 XS 183 19/8 XS 183 20/12 XS 183 20/18 XS 183 20/0 XS

Talla/Color	Amarillo flúor/verde hierba.		Naranja flúor/gris.		Amarillo flúor/rojo.		Amarillo flúor/granate.		Amarillo flúor/negro.		€/ u.
	Ref.	Código	Ref.	Código	Ref.	Código	Ref.	Código	Ref.	Código	
XS	8003353	183 180 XS	8003360	183 19/8 XS	8003367	183 20/12 XS	8003374	183 20/18 XS	8003381	183 20/0 XS	28,82
S	8003354	183 180 S	8003361	183 19/8 S	8003368	183 20/12 S	8003375	183 20/18 S	8003382	183 20/0 S	
M	8003355	183 180 M	8003362	183 19/8 M	8003369	183 20/12 M	8003376	183 20/18 M	8003383	183 20/0 M	
L	8003356	183 180 L	8003363	183 19/8 L	8003370	183 20/12 L	8003377	183 20/18 L	8003384	183 20/0 L	
XL	8003357	183 180 XL	8003364	183 19/8 XL	8003371	183 20/12 XL	8003378	183 20/18 XL	8003385	183 20/0 XL	
XXL	8003358	183 180 XXL	8003365	183 19/8 XXL	8003372	183 20/12 XXL	8003379	183 20/18 XXL	8003386	183 20/0 XXL	
3XL	8003359	183 180 3XL	8003366	183 19/8 3XL	8003373	183 20/12 3XL	8003380	183 20/18 3XL	8003387	183 20/0 3XL	

Forro polar de alta visibilidad



Forro polar de alta visibilidad combinado con cremallera completa. Certificado en alta visibilidad [EN 20471] y ambientes fríos [EN14058]. Dispone de cremallera completa con protector de barbilla en el borde superior de la misma, lo que facilita su uso. El tejido de alto gramaje dota a la prenda de unas características idóneas para ser utilizada en ambientes fríos y bajas temperaturas (hasta - 5°). Dispone de cinta elástica con stoppers en la cintura para un óptimo ajuste de la prenda. El forro polar dispone de dos bolsillos con cierre por medio de cremallera y forro en el mismo tejido que la prenda, lo cuál contribuye a que la prenda ofrezca un nivel de confort térmico excepcional.



PLANET ORANGE/NAVY 2XL PLANET YELLOW/GREEN 2XL PLANET YELLOW/GREY 2XL PLANET YELLOW/NAVY 2XL

Talla/Color	Naranja/Azul navy.		Amarillo/Verde.		Amarillo/Gris.		Amarillo/Azul navy.		€/ u.
	Ref.	Código	Ref.	Código	Ref.	Código	Ref.	Código	
XS	2401850	PLANET ORANGE/NAVY XS	2401859	PLANET YELLOW/GREEN XS	2401868	PLANET YELLOW/GREY XS	2401877	PLANET YELLOW/NAVY XS	25,71
S	2401848	PLANET ORANGE/NAVY S	2401857	PLANET YELLOW/GREEN S	2401866	PLANET YELLOW/GREY S	2401875	PLANET YELLOW/NAVY S	
M	2401847	PLANET ORANGE/NAVY M	2401856	PLANET YELLOW/GREEN M	2401865	PLANET YELLOW/GREY M	2401874	PLANET YELLOW/NAVY M	
L	2401846	PLANET ORANGE/NAVY L	2401855	PLANET YELLOW/GREEN L	2401864	PLANET YELLOW/GREY L	2401873	PLANET YELLOW/NAVY L	
XL	2401849	PLANET ORANGE/NAVY XL	2401858	PLANET YELLOW/GREEN XL	2401867	PLANET YELLOW/GREY XL	2401876	PLANET YELLOW/NAVY XL	
XXL	2401842	PLANET ORANGE/NAVY 2XL	2401851	PLANET YELLOW/GREEN 2XL	2401860	PLANET YELLOW/GREY 2XL	2401869	PLANET YELLOW/NAVY 2XL	
3XL	2401843	PLANET ORANGE/NAVY 3XL	2401852	PLANET YELLOW/GREEN 3XL	2401861	PLANET YELLOW/GREY 3XL	2401870	PLANET YELLOW/NAVY 3XL	
4XL	2401844	PLANET ORANGE/NAVY 4XL	2401853	PLANET YELLOW/GREEN 4XL	2401862	PLANET YELLOW/GREY 4XL	2401871	PLANET YELLOW/NAVY 4XL	
5XL	2401845	PLANET ORANGE/NAVY 5XL	2401854	PLANET YELLOW/GREEN 5XL	2401863	PLANET YELLOW/GREY 5XL	2401872	PLANET YELLOW/NAVY 5XL	



07

Chaleco acolchado bicolor de alta visibilidad.



305902 19/61 S



305902 20/61 S

Talla/Color	Naranja flúor/azul navy.		Amarillo flúor/azul navy.		€ / u.
	Ref.	Código	Ref.	Código	
S	8003482	305902 19/61 S	8003488	305902 20/61 S	35,38
M	8003483	305902 19/61 M	8003489	305902 20/61 M	
L	8003484	305902 19/61 L	8003490	305902 20/61 L	
XL	8003485	305902 19/61 XL	8003491	305902 20/61 XL	
XXL	8003486	305902 19/61 XXL	8003492	305902 20/61 XXL	
3XL	8003487	305902 19/61 3XL	8003493	305902 20/61 3XL	

Chaleco con cintas acolchado multibolsillos de alta visibilidad



205904 0 L



205904 61 L



205904 8 L

Talla/Color	Negro.		Azul navy.		Gris.		€ / u.
	Ref.	Código	Ref.	Código	Ref.	Código	
S	8003843	205904 0 S	8003849	205904 61 S	8003855	205904 8 S	29,78
M	8003842	205904 0 M	8003848	205904 61 M	8003854	205904 8 M	
L	8003841	205904 0 L	8003847	205904 61 L	8003853	205904 8 L	
XL	8003844	205904 0 XL	8003850	205904 61 XL	8003856	205904 8 XL	
XXL	8003845	205904 0 XXL	8003851	205904 61 XXL	8003857	205904 8 XXL	
3XL	8003846	205904 0 3XL	8003852	205904 61 3XL	8003858	205904 8 3XL	

Parka 4 en 1 bicolor de alta visibilidad



306003 70 S



306003 210 S

Talla/Color	Amarillo flúor/azul marino.		Naranja flúor/azul marino.		€ / u.
	Ref.	Código	Ref.	Código	
S	8003305	306003 70 S	8003311	306003 210 S	81,98
M	8003306	306003 70 M	8003312	306003 210 M	
L	8003307	306003 70 L	8003313	306003 210 L	
XL	8003308	306003 70 XL	8003314	306003 210 XL	
XXL	8003309	306003 70 XXL	8003315	306003 210 XXL	
3XL	8003310	306003 70 3XL	8003316	306003 210 3XL	

Parkas y cazadoras alta visibilidad



Bandas reflectantes de 3M® Scotchlite™. Cierre frontal con cremallera y botones a presión. Dispone de dos bolsillos frontales con cierre de velcro y un bolsillo interior. Capucha interna con cierre de cremallera.



Talla/Color	Amarillo flúor.		€ / u.
	Ref.	Código	
M	1012850	HV703/M	79,40
L	1012851	HV703/L	
XL	1012852	HV703/XL	
XXL	1012853	HV703/XXL	

Talla/Color	Amarillo flúor/azul marino.		€ / u.
	Ref.	Código	
M	1012864	HV780/M	134,28
L	1012865	HV780/L	
XL	1012866	HV780/XL	
XXL	1012867	HV780/XXL	

Parka bicolor alta visibilidad



Talla/Color	Amarillo flúor/azul marino.		Naranja flúor/azul marino.		Amarillo flúor/verde.		Amarillo flúor/gris.		€ / u.
	Ref.	Código	Ref.	Código	Ref.	Código	Ref.	Código	
S	8003317	306002 70 S	8003323	306002 210 S	20021429	306002 20/2 S	20021437	306002 20/8 S	52,58
M	8003318	306002 70 M	8003324	306002 210 M	20021428	306002 20/2 M	20021436	306002 20/8 M	
L	8003319	306002 70 L	8003325	306002 210 L	20021427	306002 20/2 L	20021435	306002 20/8 L	
XL	8003320	306002 70 XL	8003326	306002 210 XL	20021430	306002 20/2 XL	20021438	306002 20/8 XL	
XXL	8003321	306002 70 XXL	8003327	306002 210 XXL	20021431	306002 20/2 XXL	20021439	306002 20/8 XXL	
3XL	8003322	306002 70 3XL	8003328	306002 210 3XL	20021432	306002 20/2 3XL	20021440	306002 20/8 3XL	

Buzo HV ignífugo y antiestático



Buzo de gran confort y diseño para soldadura o afines fabricado en Algodón 78% con tratamiento FR, fibra de poliéster 20% y fibra antiestática 2%. Dos bolsillos frontales con tapeta apesillada y cierre por velcro. Dos bolsillos posteriores con tapetas apesilladas y cierre por velcro. Dos bolsillos tipo francés. Elástico posterior en cintura. Cremallera FR con sistema antipánico. Cuello alto para mayor protección de radiaciones por soldadura. Bandas reflectantes en mangas, torso y perneras. Alta visibilidad clase 2. Gramaje 290 gr/m2. Color: azul marino / amarillo flúor. TALLAS: S-M-L-XL-XXL-3XL CATEGORIA CE: CAT III



Talla/Color	Amarillo flúor/azul marino.		€ / u.
	Ref.	Código	
XS	8001692	WLH400-S	120,10
M	8001693	WLH400-M	120,10
L	8001694	WLH400-L	120,10
XL	8001695	WLH400-XL	120,10
XXL	8001696	WLH400-XXL	120,10
3XL	8001697	WLH400-3XL	120,10



Pantalón HV ignífugo y antiestático



Pantalón de gran confort y diseño para soldadura o afines fabricado en Algodón 78% con tratamiento FR, fibra de poliéster 20% y fibra antiestática 2%. Dos bolsillos posteriores con tapeta apresillada y cierre por velcro. Dos bolsillos tipo francés. Elástico posterior en cintura. Cremallera FR. Bandas reflectantes y alta visibilidad. Gramaje 290 gr/m2. Color: azul marino. Tallas: S-M-L-XL-XXL-3XL Categoría CE: CAT III



Talla/Color	Amarillo flúor/azul marino.		€ / u.
	Ref.	Código	
S	8001710	WLH200-S	86,40
M	8001711	WLH200-M	
L	8001712	WLH200-L	
XL	8001713	WLH200-XL	
XXL	8001714	WLH200-XXL	
3XL	8001715	WLH200-3XL	

Chaqueta HV ignífuga y antiestática



Chaqueta de gran confort y diseño para soldadura o afines fabricado en Algodón 78% con tratamiento FR, fibra de poliéster 20% y fibra antiestática 2%. Dos bolsillos frontales con tapeta apresillada y cierre por velcro. Elástico posterior en cintura. Bandas reflectantes en cuerpo y mangas. Cremallera FR. Cuello alto para mayor protección de radiaciones por soldadura. Gramaje 290 gr/m2. Color: azul marino. Tallas: S-M-L-XL-XXL-3XL Categorías CE: CAT III



Talla/Color	Amarillo flúor/azul marino.		€ / u.
	Ref.	Código	
S	8001704	WLH300-S	86,40
M	8001705	WLH300-M	86,40
L	8001706	WLH300-L	86,40
XL	8001707	WLH300-XL	86,40
XXL	8001708	WLH300-XXL	86,40
3XL	8001709	WLH300-3XL	86,40

Camisa HV ignífuga y antiestática



Tallas: S-M-L-XL-XXL-3XL Categoría CE: CAT III

Talla/Color	Amarillo flúor/azul marino.		€ / u.
	Ref.	Código	
S	8001698	WLH100-S	82,20
M	8001699	WLH100-M	82,20
L	8001700	WLH100-L	82,20
XL	8001701	WLH100-XL	82,20
XXL	8001702	WLH100-XXL	82,20
3XL	8001703	WLH100-3XL	82,20



07

Ropa antiácido y de soldar



Mandil 10



Mandil 10-C



Mandil 10-N

Ref.	Código	Descripción	Modelo	€/ u.
1003330	2602010100	Mandil de cuero, cromo. Talla: 60 x 90 cm.	Mandil 10	21,44
1002662	2602010200	Mandil PVC laminado. Talla: 70 x 100 cm.	Mandil 10-C	11,68
1002663	2602010300	Mandil neopreno, una cara con soporte de algodón. Talla: 70 x 100 cm.	Mandil 10-N	24,13

Mandil placas de acero inoxidable. 55 x 70



Para deshuesar, con placas 100% de acero inoxidable. Reversible. La forma de las placas y su tamaño ofrecen una gran elasticidad. Resistente a los productos de limpieza corrientes y de desinfección.

Talla/Color	Gris.		€/ u.
	Ref.	Código	
50x70	1001667	OXFL17012055X070	185,60
50x80	1001668	OXFL17012055X080	217,72



Mandil malla metálica. 60 cm



Mandil de malla metálica 100% acero inoxidable. Protección de Nivel 2 según la norma EN ISO 13998. Es reversible para evitar riesgo de accidente por usarla al revés. Aporta toda la flexibilidad y el confort de la malla metálica y garantiza la facilidad de movimiento para el trabajador.

Talla/Color	Gris.		€/ u.
	Ref.	Código	
55x70	1001669	OXLI65012055X070	215,48
55x80	1001670	OXLI65012055X080	226,84



Ropa antiácido y de soldar



Manguitos 8

Polainas 9



Ref.	Código	Descripción	Modelo	€/ u.
1003331	2604008100	Material: Piel. Talla: 60 cm.	Manguitos 8	15,84
1003332	2601009100	Material: Piel. Talla: 25 X 30 cm.	Polainas 9	14,94



Faja polivalente

Ref.	Código	Código	Talla	€ / u.
1003500	800	800	Única	25,10



Faja soporte abdominal dorsal

Ref.	Código	Código	Talla	€ / u.
1003600	825P	825P	66-82	47,60
1003601	825M	825M	83-99	47,60
1003602	825G	825G	100-116	47,60
1003603	825EG	825EG	117-135	47,60



Ropa para soldar



Ref.	Código	Talla	Talla	€ / u.
1004200	451C	Única	Única	16,82
1004201	451H	Única	Única	22,30
1004202	452A	Única	Única	27,44
1004203	250/P	Pequeña	Pequeña	123,68
1004204	250/M	Mediana	Mediana	124,20
1004205	250/G	Grande	Grande	126,10

Ropa para soldar



888-CHS10



888-MD



888-MGH



888-PL

Ref.	Código	Código	€ / u.
1001440	888-CHS10	888-CHS10	42,24
1001441	888-CHS12	888-CHS12	42,24
1001442	888-MD	888-MD	11,65
1001443	888-MG	888-MG	8,83
1001444	888-MGH	888-MGH	11,01
1001445	888-PL	888-PL	12,48

Muñequera

Ref.	Código	Código	Talla	€ / u.
1003700	850	850	Única	9,90



Rodillera

Ref.	Código	Código	Talla	€ / u.
1003800	852P	852P	30-33	20,80
1003801	852M	852M	34-37	20,80
1003802	852G	852G	38-41	20,80
1003803	852EG	852EG	42-45	20,80



Tobillera

Ref.	Código	Código	Talla	€ / u.
1003900	854P	854P	18-20	14,20
1003901	854M	854M	21-23	14,20
1003902	854G	854G	24-26	14,20
1003903	854EG	854EG	27-29	14,20



Fajas



15-C



16-C



17-C



18-C



19-C

Ref.	Código	Modelo	Talla	€ / u.
1003335	2651015101	15-C T. L-XL	L-XL	20,06
1003336	2651015100	15-C T. S-M	S-M	20,06
1003337	2651016100	16-C T. S-M	S-M	18,05
1003338	2651016101	16-C T. L-XL	L-XL	18,50
1003339	2651016102	16-C T. XXL-XXXL	XXL-XXXL	18,96
1003340	2651017200	17-C T. S-M	S-M	38,05
1003341	2651017201	17-C T. XL	L-XL	39,18
1003342	2651017100	17-C T. S-M	S-M	35,17
1003343	2651017101	17-C T. XL	L-XL	36,22
1003344	2651018101	18-C T. M	S-M-L-XL	31,28
1003345	2651019201	19-C T. M	S-M-L-XL	31,28

Guante desechable de uso general



El nitrilo aporta mayor durabilidad, elasticidad y resistencia a la perforación. Texturizado en su totalidad en la parte exterior para un mayor agarre. Ambidextros. Buen agarre en húmedo y seco. Adecuados para personas alérgicas al látex. Apto para uso alimentario



Ref.	Código	Color	Talla	€ / u.	Ref.	Código	Color	Talla	€ / u.	Ref.	Código	Color	Talla	€ / u.
Guante desechable de nitrilo sin polvo. Color azul					Guante desechable de látex sin polvo. Color azul.					Guante desechable de nitrilo sin polvo. Color negro.				
1013136	570/S		S		908017	532B/S		S		908025	572NR/S		S	
1013137	570/M	Azul	M	15,15	908018	532B/M	Azul	M	22,04	908026	572NR/M	Negro	M	23,70
1013138	570/L		L											
1013139	570/XL		XL											
Guante desechable de nitrilo sin polvo. Color azul.					Guante desechable de nitrilo sin polvo. Color azul.									
					908022	572B/M		M		908029	572NR/XXL		XXL	
					908023	572B/L	Azul	L	21,79					
					908024	572B/XL		XL						

35LBB - Guante desechable de nitrilo G.TOUCH



Talla/Color	Azul.		€ / u.
	Ref.	Código	
3,5 Gr	2401878	00000125	3,50
3,5 Gr	2401879	00000126	
3,5 Gr	2401880	00000127	
3,5 Gr	2401881	00000128	



46DBB - Guante desechable de nitrilo PRO



Talla/Color	Azul.		€ / u.
	Ref.	Código	
4,6 Gr	2401882	00000504	4,18
4,6 Gr	2401883	00000505	
4,6 Gr	2401884	00000506	
4,6 Gr	2401885	00000507	



50BLK - Guante desechable de nitrilo PRO



Talla/Color	Negro.		€ / u.
	Ref.	Código	
5.0 Gr	2401886	00000512	4,24
5.0 Gr	2401887	00000513	
5.0 Gr	2401888	00000514	
5.0 Gr	2401889	00000515	



60GSP - Guante desechable de nitrilo HQ



Talla/Color	Verde.		€ / u.
	Ref.	Código	
6,0 Gr	2401890	00000404	6,16
6,0 Gr	2401891	00000405	
6,0 Gr	2401892	00000406	
6,0 Gr	2401893	00000407	



84ORG- Guante desechable de nitrilo GRIP



Formato 50 uds por estuche

Talla/Color	Naranja.		€ / u.
	Ref.	Código	
8.5 Gr	2401894	00000820	4,92
8.5 Gr	2401895	00000821	
8.5 Gr	2401896	00000822	
8.5 Gr	2401897	00000823	
8.5 Gr	2401898	00000824	



RNF15 - Guante de nitrilo flocado PREMIUM



Talla/Color	Verde.		€ / u.
	Ref.	Código	
0,40 mm	2401899	00000061	1,50
0,40 mm	2401900	00000062	
0,40 mm	2401901	00000063	
0,40 mm	2401902	00000064	
0,40 mm	2401903	00000065	



RNU2218 - Guante de nitrilo extra largo



Talla/Color	Verde.		€ / u.
	Ref.	Código	
0,58 mm	2401904	00000113	4,40
0,58 mm	2401905	00000114	
0,58 mm	2401906	00000115	
0,58 mm	2401907	00000116	



NEO400 - Guante de neopreno industrial



Talla/Color	Negro.		€ / u.
	Ref.	Código	
0,68 mm	2401908	00000238	1,80
0,68 mm	2401909	00000239	
0,68 mm	2401910	00000240	
0,68 mm	2401911	00000241	



HD27 NEO - Guante de neopreno/látex industrial



Talla/Color	Negro.		€ / u.
	Ref.	Código	
0,68 mm	2401912	00000228	1,48
0,68 mm	2401913	00000229	
0,68 mm	2401914	00000230	
0,68 mm	2401915	00000231	
0,68 mm	2401916	00000232	



HP300 - Guante de neopreno/látex PREMIUM bicolor



Talla/Color	Amarillo/azul.		€ / u.
	Ref.	Código	
0,70 mm	2401917	00000254	1,64
0,70 mm	2401918	00000255	1,64
0,70 mm	2401919	00000256	
0,70 mm	2401920	00000257	1,60
0,70 mm	2401921	00000258	



Guantes desechables de nitrilo sin polvo, 300 mm de largo



El nitrilo aporta mayor durabilidad, elasticidad y resistencia a la perforación. Texturizado total para mejor agarre en diferentes superficies: seco, húmedo y aceitado. Adecuados para personas alérgicas al látex. Apto para uso alimentario

Talla/Color	Negro.		€ / u.
	Ref.	Código	
7	2401922	573NR/7	10,01
8	2401923	573NR/8	
9	2401924	573NR/9	
10	2401925	573NR/10	



Guante desechable de nitrilo sin polvo



El nitrilo aporta mayor durabilidad, elasticidad y resistencia a la perforación. Adecuados para personas alérgicas al látex. Este guante desechable protege contra las siguientes sustancias químicas: Hidróxido Sódico 40% (nivel 6, >480 minutos), Hidróxido amónico 25% (nivel 1, >10 minutos), Peróxido de Hidrógeno (nivel 3, >60 minutos) y Formaldehído 37% (nivel 2, >30 minutos)



570NR/6



576/6

Talla/Color	Negro.		€ / u.
	Ref.	Código	
6	2401926	570NR/6	16,60
7	2401927	570NR/7	
8	2401928	570NR/8	
9	2401929	570NR/9	

Talla/Color	Azul.		€ / u.
	Ref.	Código	
6	2401930	576/6	8,24
7	2401931	576/7	
8	2401932	576/8	
9	2401933	576/9	
11	2401934	576/11	
10	2401935	576/10	



Guante desechable de uso general

Calidad extra. El látex aporta mayor precisión y sensibilidad. Excelente confort y ajuste a la mano. Ambidextros. Certificados para uso alimentario. Para bacterias y hongos este guante tiene estanqueidad total según EN 374-2:2018

Talla/Color	Natural.		€/ u.
	Ref.	Código	
M	1013125	530/M	17,94
L	1013126	530/L	
XL	1013127	530/XL	



Guante desechable de protección química



Guante desechable , texturizado en palma y dorso tipo diamante . Grosor 5 grs y Color AZUL

Talla/Color	Negro.		€/ u.
	Ref.	Código	
XL/10	2401936	2560	12,68



Guante desechable sin polvo



Guante desechable , texturizado en palma y dorso tipo diamante . Grosor 5 grs y Color AZUL

Talla/Color	Azul.		€/ u.
	Ref.	Código	
S/7	2401937	2100	12,68
M/8	2401938	2100	12,68
L/9	2401939	2100	12,68
XL/10	2401940	2100	12,68



Nitrilo fino sin polvo. 4,8 gr/pcs. Grosor: 0,20 mm



Talla/Color	Azul.		€/ u.
	Ref.	Código	
7	1002450	NA48-S	6,70
8	1002451	NA48-M	
9	1002452	NA48-L	
10	1002453	NA48-XL	



Nitrilo sin polvo. 6 gr/pcs. Grosor: 0,26 mm. Impermeable. AQL: 1,5



Talla/Color	Negro.		€/ u.
	Ref.	Código	
7	1002454	NN60-S	12,41
8	1002455	NN60-M	
9	1002456	NN60-L	
10	1002457	NN60-XL	



Guante de nitrilo caucho sintético con buena resistencia a aceites



Nitrilo caucho sintético con buena resistencia a aceites, lubricantes y productos derivados del petróleo. Resistente a productos químicos, ácidos y disolventes no cetónicos. Impermeable. Ambidiestro. No esteril. AQL 1,5. Interior sin polvo para evitar alergias. Desteridad nivel 5 (mínimo 0, máximo 5).

Talla/Color	Azul.		€ / u.
	Ref.	Código	
7	2401941	NA35-S	5,52
8	2401942	NA35-M	
9	2401943	NA35-L	
10	2401944	NA35-XL	



Fathom 45 G. Satinado de látex sin soporte



Cumple la norma EN421 que certifica los guantes de PROTECCIÓN CONTRA RADIACIONES IONIZANTES Y CONTAMINACIÓN RADIATIVA. Muy flexible y con forma anatómica por lo que ofrece un gran confort. Patrón antideslizante con acabado en panel de abeja para un óptimo agarre. Clorinado para mayor resistencia química y bajo en proteínas solubles. Se comercializa en bolsa individual para punto de venta. Apto para uso alimentario.

Talla/Color	Azul.		€ / u.
	Ref.	Código	
6-6,5	1001463	611B/6-6.5	1,89
7-7,5	1001464	611B/7-7.5	
8-8,5	1001465	611B/8-8.5	
9-9,5	1001466	611B/9-9.5	



Interface Soft Guante nitrilo satinado 0,20 mm



Extra fino, excelente tacto, sensibilidad y desteridad. Clorinado para mayor resistencia química, reduce las proteínas solubles y aceleradores residuales. Patrón antideslizante para un óptimo agarre en ambientes húmedos, secos y aceitosos. Resistencia a solventes. Apto para uso alimentario.

Talla/Color	Azul.		€ / u.
	Ref.	Código	
6-6,5	1001467	811/6-6.5	2,68
7-7,5	1001468	811/7-7.5	
8-8,5	1001469	811/8-8.5	
9-9,5	1001470	811/9-9.5	



Guante "Agility®" de nylon recubierto de nitrilo con forro interior



Ergonómico y ligero. Especial uso alimentario. Excelente agarre en ambientes secos y húmedos.

Talla/Color	Azul.		€ / u.
	Ref.	Código	
7	1001471	5160W/7	10,10
8	1001472	5160W/8	
9	1001473	5160W/9	
10	1001474	5160W/10	



Sensiderm Guante PVC satinado



Excepcional confort gracias a su formulación especial. Forma anatómica para mayor ajuste de la mano. Ofrece un buen agarre en ambientes húmedos y secos. Tacto muy suave y confortable. Hipoalérgico, gama ideal para los usuarios alérgicos.

Talla/Color	Azul.		€ / u.
	Ref.	Código	
7	1001475	G2NDB/7	2,50



“Ninja Ice” nylon negro/acrílico palma PVC



Interior con acabado de vulrizo que protege contra el frío y las bajas temperaturas [-10°C]. Palma recubierta de PVC con tecnología HPT (Hydropellent Technology) que repele los líquidos en situaciones moderadas, y proporciona un excelente agarre en ambientes secos o húmedos. Gran resistencia y muy duradero. Apto para uso alimentario.



Talla/Color	Negro.		€ / u.
	Ref.	Código	
7	1001479	NI00/7	8,57
8	1001480	NI00/8	
9	1001481	NI00/9	
10	1001482	NI00/10	

Guante Nylon® palma recubierta de nitrilo estanco. Especial uso alimentario.



Nitrilo de calidad extra. Excelente agarre en ambientes secos, húmedos y aceitosos. Proporciona un gran confort, ergonomía y transpirabilidad. Apto para el contacto con alimentos acuosos, alcohólicos y lácteos pero no apto para el uso con alimentos ácidos



Talla/Color	Azul.		€ / u.
	Ref.	Código	
6	21060029	116161/6	2,30
7	21060030	116161/7	
8	21060031	116161/8	
9	21060032	116161/9	
10	21060033	116161/10	

Guante de fibra anticorte sin recubrimiento. Apto alimentación.



Soporte sin costuras con tecnología textil K-ROCK que aporta tacto, flexibilidad y confort. Ambidextro. Proporciona un buen agarre, confort y flexibilidad. Nivel máximo de protección al corte. Especial uso alimentario. Se pueden utilizar debajo de otros guantes para una protección extra.



Talla/Color	Negro.		€ / u.
	Ref.	Código	
6	21060035	5020BL/6	8,39
7	21060036	5020BL/7	
8	21060037	5020BL/8	
9	21060038	5020BL/9	
10	21060039	5020BL/10	

Guante HPPE con doble recubrimiento bpolímero (nitrilo + PU de base acuosa). Apto uso alimentario.



Excelente estanqueidad gracias a su doble recubrimiento de bpolímero. Recubierto en palma y dedo pulgar de nitrilo arenoso ofreciendo un sólido agarre en ambientes secos, húmedos y aceitosos. Optimiza la destreza y el tacto en comparación con el uso de un doble guante. Resistente al calor por contacto [100°C durante 15 segundos]. Su forro interior de alta visibilidad hace que de producirse cortes se detecten rápidamente. El manguito se puede doblar para evitar que los productos químicos resbalen por el brazo.



Talla/Color	Verde.		€ / u.
	Ref.	Código	
7	21060041	5813/7	18,51
8	21060042	5813/8	
9	21060043	5813/9	
10	21060044	5813/10	

Guante Nitrilo granulado sobre soporte de algodón. Largo de 50 cm. Apto uso alimentario



Su forro interior de algodón proporciona un gran confort. Recubierto en palma y dorso de NITRILLO RUGOSO ofreciendo un sólido agarre en ambientes SECOS, HÚMEDOS y ACEITOSOS. Resistente al CALOR POR CONTACTO (100°C durante 15"). APTO PARA USO ALIMENTARIO, es apropiado para todos los alimentos acuosos, alcohólicos, ácidos y los productos lácteos. Incluso para los alimentos grasos con un factor de reducción X/2.



Talla/Color	Azul.		€ / u.
	Ref.	Código	
7	21060045	822/7	33,31
8	21060046	822/8	
9	21060047	822/9	
10	21060048	822/10	

Guante de poliéster recubierto en palma con poliuretano. Apto para alimentación



Apto para alimentación gracias a su poliuretano de alta calidad. Sin marcado y con etiqueta interior para la industria alimentaria, La galga fina le confieren un excelente tacto y flexibilidad. Soporte en color azul para una mejor identificación en el entorno alimentario



Talla/Color	Azul.		€ / u.
	Ref.	Código	
6	2401945	SP4119/6	1,29
7	2401946	SP4119/7	
8	2401947	SP4119/8	
9	2401948	SP4119/9	
10	2401949	SP4119/10	
11	2401950	SP4119/11	

Guante de poliéster recubierto en palma con poliuretano. Apto para alimentación (Bolsa individual)



Apto para alimentación gracias a su poliuretano de alta calidad. Sin marcado y con etiqueta interior para la industria alimentaria, La galga fina le confieren un excelente tacto y flexibilidad. Soporte en color azul para una mejor identificación en el entorno alimentario



Talla/Color	Azul.		€ / u.
	Ref.	Código	
6	2401951	BNSP4119/6	1,50
7	2401952	BNSP4119/7	
8	2401953	BNSP4119/8	
9	2401954	BNSP4119/9	
10	2401955	BNSP4119/10	
11	2401956	BNSP4119/11	

Guante sin costuras de nailon con doble recubrimiento de nitrilo. Apto para alimentación



Totalmente recubierto (a la primera capa de nitrilo estanco se le incorpora una segunda capa de nitrilo arenoso) ofreciendo un buen agarre en entornos secos, húmedos y aceitados. Especial uso alimentario



Talla/Color	Azul.		€ / u.
	Ref.	Código	
6	2401957	1161FC/6	4,45
7	2401958	1161FC/7	
8	2401959	1161FC/8	
9	2401960	1161FC/9	
10	2401961	1161FC/10	
11	2401962	1161FC/11	



Interface Plus Guante nitrilo, flocado sin soporte.

Clorinado para mayor resistencia química, reduce las proteínas solubles y aceleradores residuales. Flocado interior de algodón para absorber el sudor y proveer al usuario de un mayor confort. Patrón antideslizante para un óptimo agarre en ambientes húmedos, secos y aceitosos. Muy buena resistencia a la abrasión. Resistencia a disolventes. Apto para uso alimentario



Talla/Color	Verde.		€ / u.
	Ref.	Código	
6	1013140	821/6	3,32
7	1013141	821/7	
8	1013142	821/8	
9	1013143	821/9	
10	1013144	821/10	

Guante de nitrilo azul sobre soporte de algodón. Largo 30 cms. Grosor 0,8 mm.



Buena resistencia a la abrasión por lo que ofrece una gran durabilidad. Muy flexible, cómodo y resistente. Superficie arenosa que permite un agarre firme de objetos secos, mojados y aceitosos. Algodón interior para absorber el sudor y proveer de un mayor confort. Apto para uso alimentario.



Talla/Color	Azul.		€ / u.
	Ref.	Código	
8	1013145	G630/8	12,12
9	1013146	G630/9	
10	1013147	G630/10	

“Gripazz” G. Nitrilo ambidextro.



Diseño en escamas patentado a nivel mundial que permite que exista mayor superficie de contacto por lo que ofrece un mayor agarre en condiciones mojadas y aceitadas, superior al acabado en diamante. Zona texturizada en el interior del pulgar que ofrece un mejor agarre. Más grueso que un guante desechable tradicional por lo que proporciona mayor resistencia a la elongación y al desgarro, convirtiéndose en un guante muy duradero. El nitrilo aporta mayor durabilidad, elasticidad y resistencia a la perforación, además se adapta térmicamente a la mano para un ajuste perfecto. Ambidextros. Texturizado en su exterior para maximizar el agarre y texturizado interior que evita el desplazamiento por sudoración. Adecuados para personas alérgicas al látex. Apto para uso alimentario.



590BL/S



580NR/S



580OR/S

Talla/Color	Azul.		€ / u.
	Ref.	Código	
S	908035	590BL/S	16,25
M	908036	590BL/M	
L	908037	590BL/L	
XL	908038	590BL/XL	
XXL	908039	590BL/XXL	
3XL	908040	590BL/3XL	

Talla/Color	Negro.		Naranja.		€ / u.
S	908041	580NR/S	908046	580OR/S	15,69
M	908042	580NR/M	908047	580OR/M	
L	908043	580NR/L	908048	580OR/L	
XL	908044	580NR/XL	908049	580OR/XL	
XXL	908045	580NR/XXL	908004	580OR/XXL	

Grandeur 70 G. Látex neopreno mezclado, de peso pesado. Flocado sin soporte



Mezcla de neopreno y látex que aporta una gran resistencia química. Flocado interior de algodón que absorbe el sudor y ofrece un mayor confort. Aditivos bacteriostáticos y fungicidas. Patrón antideslizante con acabado panel de abeja para un óptimo agarre en ambientes húmedos y secos. Clorinado para mayor resistencia química, reduce las proteínas solubles y aceleradores residuales. Se comercializa en bolsa individual para punto de venta. Apto para uso alimentario.



Talla/Color	Naranja.		€ / u.
	Ref.	Código	
7-7,5	1013148	321C/7-7.5	2,89
8-8,5	1013149	321C/8-8.5	
9-9,5	1013160	321C/9-9.5	
10-10,5	1013161	321C/10-10.5	



Conqueror II G. Bicolor de látex neopreno pesado, flocado sin soporte



Mezcla de neopreno y látex ofreciendo una gran resistencia química. Flocado interior de algodón para absorber el sudor y proveer de un mayor confort. Aditivos bacteriostáticos y fungicidas. Patrón antideslizante con acabado en panel de abeja para un óptimo agarre en ambientes húmedos y secos. Palma reforzada para protección extra. Clorinado para mayor resistencia química, reduce las proteínas solubles y aceleradores residuales. Bolsa individual para punto de venta. Apto para uso alimentario.



Talla/Color	Azul/amarillo.		€ / u.
	Ref.	Código	
6-6,5	1013162	322/6-6.5	2,93
7-7,5	1013163	322/7-7.5	
8-8,5	1013164	322/8-8.5	
9-9,5	1013165	322/9-9.5	
10-10,5	1013166	322/10-10.5	

Guante PVC doble capa, con soporte de algodón. Cat. III. Largo 27 cms.



PVC de alta calidad. Algodón interlock interior para absorber el sudor y proveer de un mayor confort. Totalmente estanco gracias al recubrimiento de PVC de una capa. Excelente resistencia a la abrasión, gran durabilidad. Ofrece un agarre excelente de objetos secos, mojados y aceitosos. Libre de ftalatos. La función higienizante Sanitized® protege los guantes de la formación de hongos, ácaros y bacterias, evita los olores, proporciona una protección duradera a los polímeros y minimiza la irritación de la piel.



Talla/Color	Rojo.		€ / u.
	Ref.	Código	
8.5	1001584	227RI/8.5	4,68
9.5	1001585	227RI/9.5	

Guante PVC doble capa, con soporte de algodón. Cat. III. Largo 35 cms.



PVC de alta calidad. Algodón interlock interior para absorber el sudor y proveer de un mayor confort. Totalmente estanco gracias al recubrimiento de PVC de una capa. Excelente resistencia a la abrasión, gran durabilidad. Ofrece un agarre excelente de objetos secos, mojados y aceitosos. Libre de ftalatos. La función higienizante Sanitized® protege los guantes de la formación de hongos, ácaros y bacterias, evita los olores, proporciona una protección duradera a los polímeros y minimiza la irritación de la piel.



Talla/Color	Rojo.		€ / u.
	Ref.	Código	
8.5	1001586	235RI/8.5	6,36
9.5	1001587	235RI/9.5	

Guante PVC doble capa, con soporte de algodón. Cat. III. Largo 40 cms.



PVC de alta calidad. Algodón interlock interior para absorber el sudor y proveer de un mayor confort. Totalmente estanco gracias al recubrimiento de PVC de una capa. Excelente resistencia a la abrasión, gran durabilidad. Ofrece un agarre excelente de objetos secos, mojados y aceitosos. Libre de ftalatos. La función higienizante Sanitized® protege los guantes de la formación de hongos, ácaros y bacterias, evita los olores, proporciona una protección duradera a los polímeros y minimiza la irritación de la piel.



Talla/Color	Rojo.		€ / u.
	Ref.	Código	
8.5	1001589	240RI/8.5	7,05

07

Guante PVC triple baño. Largo 27 cm.



Muy flexible y confortable. Totalmente estanco gracias al recubrimiento de PVC de doble capa. Excelente resistencia a la abrasión, gran durabilidad. Superficie arenosa y película vinílica antideslizante, agarre firme de objetos secos, mojados y aceitosos. Algodón interior que absorbe el sudor para mayor confort. La función higienizante Sanitized® protege los guantes de la formación de hongos, ácaros y bacterias, evita los olores, proporciona una protección duradera a los polímeros y minimiza la irritación de la piel.



Talla/Color	Azul.		€/ u.
	Ref.	Código	
8	907945	5655/8	6,57
9	907946	5655/9	
10	907947	5655/10	
11	907948	5655/11	

Guante PVC triple capa con soporte de algodón. Largo de 30 cms.



Muy flexible y confortable. Totalmente estanco gracias al recubrimiento de PVC de doble capa. Excelente resistencia a la abrasión, gran durabilidad. Superficie arenosa y película vinílica antideslizante, agarre firme de objetos secos, mojados y aceitosos. Algodón interior que absorbe el sudor para mayor confort. La función higienizante Sanitized® protege los guantes de la formación de hongos, ácaros y bacterias, evita los olores, proporciona una protección duradera a los polímeros y minimiza la irritación de la piel.



Talla/Color	Azul.		€/ u.
	Ref.	Código	
8	907949	5656/8	6,88
9	907950	5656/9	
10	907951	5656/10	
11	907952	5656/11	

Guante PVC soporte algodón 30 cms.



Muy flexible y confortable. Totalmente estanco gracias al recubrimiento de PVC de doble capa. Excelente resistencia a la abrasión, gran durabilidad. Superficie arenosa y película vinílica antideslizante, agarre firme de objetos secos, mojados y aceitosos. Algodón interior que absorbe el sudor para mayor confort. La función higienizante Sanitized® protege los guantes de la formación de hongos, ácaros y bacterias, evita los olores, proporciona una protección duradera a los polímeros y minimiza la irritación de la piel.



Talla/Color	Azul.		€/ u.
	Ref.	Código	
8	907953	H5656/8	7,32
9	907954	H5656/9	
10	907955	H5656/10	
11	907956	H5656/11	

Guante PVC triple capa con forro interior de Kevlar®. Largo de 30 cms.



Totalmente estanco gracias al recubrimiento de PVC de doble capa. Muy flexible y confortable. Excelente resistencia a la abrasión por lo que ofrece una gran durabilidad. La superficie arenosa permite un agarre firme de objetos secos, mojados y aceitosos. Algodón interior para absorber el sudor y proveer de un mayor confort. Protección al corte media gracias a la fibra de Kevlar®. La función higienizante Sanitized® protege los guantes de la formación de hongos, ácaros y bacterias, evita los olores, proporciona una protección duradera a los polímeros y minimiza la irritación de la piel.



Talla/Color	Azul.		€/ u.
	Ref.	Código	
8	907957	5656KV/8	15,20
9	907958	5656KV/9	
10	907959	5656KV/10	

Guante PVC triple baño 30 cms.



Muy flexible y confortable. Totalmente estanco gracias al recubrimiento de PVC de doble capa. Excelente resistencia a la abrasión, gran durabilidad. Superficie arenosa y película vinílica antideslizante, agarre firme de objetos secos, mojados y aceitosos. Algodón interior que absorbe el sudor para mayor confort. La función higienizante Sanitized® protege los guantes de la formación de hongos, ácaros y bacterias, evita los olores, proporciona una protección duradera a los polímeros y minimiza la irritación de la piel.

Talla/Color	Rojo.		€ / u.
	Ref.	Código	
8	907960	5651/8	6,83
9	907961	5651/9	
10	907962	5651/10	
11	907963	5651/11	



Guante PVC triple baño. Largo 65 cms. Manguito termosellado



Talla/Color	Azul.		€ / u.
	Ref.	Código	
7	1001598	5657/7	26,14
8	1001599	5657/8	



“KETORESISTER” G.PVA NITRILO LIGERO AZUL



Guante extra ligero por lo que ofrece un excelente tacto y destreza, Protección química excepcional contra una amplia gama de cetonas

Talla/Color	Azul.		€ / u.
	Ref.	Código	
7	2401963	711KR/7	19,36
8	2401964	711KR/8	
9	2401965	711KR/9	
10	2401966	711KR/10	
11	2401967	711KR/11	



Guantelete de PVC verde con acabado arenoso y forro interior de algodón interlock con refuerzo extra en la palma



Acabado arenoso en la palma y dedos que aporta un gran agarre en aplicaciones húmedas. Forro interior de algodón interlock que ofrece una gran comodidad y reduce la fatiga de la mano

Talla/Color	Verde.		€ / u.
	Ref.	Código	
8	2401968	5640RF/8	9,40
9	2401969	5640RF/9	9,40
10	2401970	5640RF/10	



Nitrilo flocado. Grosor: 0,38 mm. Largo 33 cms.



Entre los usos, cabe citar: automoción, componentes electrónicos y mecánica, laboratorios y farmacéutica, química y petroquímica, pinturas y barnices, manipulación de piezas aceitadas, agricultura, construcción...

Talla/Color	Verde.		€ / u.
	Ref.	Código	
6	1002458	9009F-6/S	3,35
7	1002459	9009F-7/M	
8	1002460	9009F-8/L	
9	1002461	9009F-9/XL	
10	1002462	9009F-10/XXL	



PVC triple baño. Interior algodón. Grosor: 1,5 mm. Largo 30 cms.



Talla/Color	Azul.		€/ u.
	Ref.	Código	
7	1002463	666VINIL-7	5,43
8	1001728	666VINIL-8	
9	1001729	666VINIL-9	
10	1001730	666VINIL-10	



Guante desechable de protección química



Guante desechable, texturizado en palma y dorso tipo diamante. Grosor 9 grs.



2550

Talla/Color	Naranja.		Negro.		€/ u.
	Ref.	Código	Ref.	Código	
S/7	2401971	2550	2401975	2560	9,98
M/8	2401972	2550	2401976	2560	9,98
L/9	2401973	2550	2401977	2560	9,98
XL/10	2401974	2550			9,98

Guante de nitrilo (NBR) flocado



Guante formulado especialmente en látex de nitrilo (butadieno-acrilonitrilo). Libre de ceras y siliconas. Altamente flexibles y confortables para la protección de la mano. Excelente resistencia a la abrasión. Químicamente endurecido para resistir contra la mayoría de los solventes, incluyendo aromáticos y petróleo. No se hinchan o degradan con grasas o aceites. 330 ± 10 mm de longitud total.

Talla/Color	Verde.		€/ u.
	Ref.	Código	
7	1002375	RNF-15/7	3,54
8	1002376	RNF-15/8	
9	1002377	RNF-15/9	
10	1002378	RNF-15/10	



Guante policloropropeno sobre latex natural



Guante Industrial para trabajos duros. Flocado interior. Libre de ceras y siliconas. Bajo contenido en proteínas. Grabado exterior para proporcionar agarre extra. Buena dexteridad y sensibilidad. 320 ± 10 mm de longitud total.

Talla/Color	Negro.		€/ u.
	Ref.	Código	
7	1002379	HD-27/7	2,45
8	1002380	HD-27/8	
9	1002381	HD-27/9	
10	1002382	HD-27/10	



Guante 100% latex natural flocado



Guante con flocado interior. Bajo contenido en proteínas. Palma y dedos con relieve "honeycomb". Confortables y de larga duración. Exento de ceras y siliconas. 320 ± 10 mm de longitud total.

Talla/Color	Naranja.		€ / u.
	Ref.	Código	
7	8001644	HD-35-S/7	3,53
8	8001645	HD-35-S/8	
9	8001646	HD-35-S/9	
10	8001647	HD-35-S/10	



Guante policloropropeno sobre latex natural. Bi-color



Guante sin soporte de policloropropeno (neopreno) sobre látex natural. Flocado interior. Libre de ceras y siliconas. Bajo contenido en proteínas. Químicamente endurecido. Relieve en la palma para potenciar el máximo agarre en condiciones húmedas o secas. 320 ± 10 mm de longitud total.

Talla/Color	Azul/amarillo.		€ / u.
	Ref.	Código	
7	8001648	HP-300/7	2,67
8	8001649	HP-300/8	
9	8001650	HP-300/9	
10	8001651	HP-300/10	



Guante soporte Kevlar + Doble recubrimiento PVC. Largo 30 cms.



Talla/Color	Negro/verde.		€ / u.
	Ref.	Código	
8	8002177	668 CHEMCUT-8	22,57
8	8002178	668 CHEMCUT-9	
8	8002179	668 CHEMCUT-10	



Guante de nylon sin costuras, liso, 42 gr/par



No desprende pelusa. Tecnología 'pre-steam', que permite que el guante mantenga su forma original después de lavado. Amplio tallaje. Óptimo ajuste a la mano.

Talla/Color	Blanco.		€ / u.
	Ref.	Código	
S	1001483	DM3440MW/S	2,02
M	1001484	DM3440MW/M	
L	1001485	DM3440MW/L	



Guante 65% Poliester/algodón



Ergonómico. Ambidextro. Amplio tallaje. Transpirable.

Talla/Color	Jaspeado.		€ / u.
	Ref.	Código	
S	1001487	440/S	0,82
M	1001488	440/M	
L	1001489	440/L	



Guante de nylon con palma recubierta de PU negro "Económico"



Poliuretano de calidad extra. Forma más cómoda. Buen tacto y transpirable. Manipulaciones confortables y precisas. Color oscuro para entornos sucios. Con bolsa individual para el punto de venta.



Talla/Color	Negro.		€/ u.
	Ref.	Código	
6	1001490	BPU1400/6	1,79
7	1001491	BPU1400/7	
8	1001492	BPU1400/8	
9	1001493	BPU1400/9	
10	1001494	BPU1400/10	

Guante de nylon sin costuras con puntos de PVC



Muy ergonómicos y óptimo ajuste a la mano, mejor que el tradicional guante de algodón. No desprende 'pelusilla'. Tecnología 'pre-steam', que permite que el guante mantenga su forma original después de lavado. Mayor agarre y resistencia a la abrasión por los puntos de PVC.



Talla/Color	Azul.		€/ u.
	Ref.	Código	
S	1001495	DM3/S	2,40
M	1001496	DM3/M	
L	1001497	DM3/L	
XL	1001498	DM3/XL	

Guante de poliamida con recubrimiento PVC



Con tecnología HPT (hydropellent technology) que repele los líquidos. Excelente agarre en condiciones húmedas y secas gracias a la tecnología CFT (Compress Foam Technology) aplicada en el recubrimiento de PVC. Buena resistencia a la abrasión, mayor durabilidad. Sin DMF. Buena destreza, flexibilidad y ergonomía. La función higienizante Sanitized® protege los guantes de la formación de hongos, ácaros y bacterias, evita los olores, proporciona una protección duradera a los polímeros y minimiza la irritación de la piel.



Talla/Color	Negro.		€/ u.
	Ref.	Código	
7	1001509	5140/7	4,49
8	1001510	5140/8	
9	1001511	5140/9	
10	1001512	5140/10	

Junit® Guante de nylon con recubrimiento nitrilo palma



Nitrilo de calidad extra. Buena resistencia a la abrasión. Impermeable en la zona cubierta. Máxima ergonomía. Excelente agarre en superficies secas, húmedas, aceitadas o grasientas.



Talla/Color	Blanco/gris.		€/ u.
	Ref.	Código	
6	1001513	AC5440/6	4,03
7	1001514	AC5440/7	
8	1001515	AC5440/8	
9	1001516	AC5440/9	
10	1001517	AC5440/10	

Guante de poliamida/algodón con recubrimiento caucho rugoso



Látex de calidad extra y larga duración. Proporciona un sólido agarre en entornos secos y húmedos. Dedo pulgar recubierto de látex, protección adicional para una zona expuesta a golpes y cortes (un 15% de los accidentes de corte suceden en esa área). Tacto y agarre excepcionales.

Talla/Color	Azul.		€ / u.
	Ref.	Código	
7	1001518	300/7	5,92
8	1001519	300/8	
9	1001520	300/9	
10	1001521	300/10	



Guante de poliamida rojo, recubierto de latex rugoso



Tacto extra y muy flexible. Proporciona un sólido agarre en entornos secos y húmedos. Buena resistencia a la abrasión, mayor durabilidad. La función higienizante Sanitized® protege los guantes de la formación de hongos, ácaros y bacterias, evita los olores, proporciona una protección duradera a los polímeros y minimiza la irritación de la piel.

Talla/Color	Gris.		€ / u.
	Ref.	Código	
7	1013175	H256/7	3,54
8	1013176	H256/8	
9	1013177	H256/9	
10	1013178	H256/10	



Agility® Guante de poliester/algodón recubierto de nitrilo Foam en su totalidad



Nitrilo NFT de máxima calidad. Transpirabilidad. Gran resistencia a la abrasión, mayor durabilidad. Proporciona un sólido agarre en entornos secos, ligeramente húmedos o aceitosos. La función higienizante Sanitized® protege los guantes de la formación de hongos, ácaros y bacterias, evita los olores, proporciona una protección duradera a los polímeros y minimiza la irritación de la piel.

Talla/Color	Negro/gris.		€ / u.
	Ref.	Código	
7	1013179	5111FCNFT/7	6,28
8	1013180	5111FCNFT/8	
9	1013181	5111FCNFT/9	
10	1013182	5111FCNFT/10	



Agility® Guante de poliester/algodón recubierto de nitrilo Foam en la palma



Nitrilo NFT de máxima calidad. Transpirabilidad. Gran resistencia a la abrasión, mayor durabilidad. Proporciona un sólido agarre en entornos secos, ligeramente húmedos o aceitosos. La función higienizante Sanitized® protege los guantes de la formación de hongos, ácaros y bacterias, evita los olores, proporciona una protección duradera a los polímeros y minimiza la irritación de la piel.

Talla/Color	Gris.		€ / u.
	Ref.	Código	
6	1013183	5111NFT/6	4,84
7	1013184	5111NFT/7	
8	1013185	5111NFT/8	
9	1013186	5111NFT/9	
10	1013187	5111NFT/10	



Guante de nylon® recubierto de nitrilo foam ultra ligero en palma. Especial pantallas táctiles



Tecnología Smart-Tip® que permite el uso de dispositivos táctiles. Óptimo tacto y ajuste a la mano.

Talla/Color	Naranja.		€ / u.
	Ref.	Código	
7	1001522	H4120/7	5,50
8	1001523	H4120/8	
9	1001524	H4120/9	
10	1001525	H4120/10	



Guante de algodón / Spandex con recubrimiento de nitrilo tipo arenoso en palma



Proporciona un sólido agarre en entornos secos, ligeramente húmedos o aceitosos. Acabado interior alfelpado que proporciona un excelente confort en condiciones de frío moderado.

Talla/Color	Gris.		€ / u.
	Ref.	Código	
7	1001526	H4117/7	5,46
8	1001527	H4117/8	
9	1001528	H4117/9	
10	1001529	H4117/10	



Guante de nylon®/elastano sin costuras con doble recubrimiento de nitrilo con tecnología T-Touch™. Especial aceites.



Nitrilo de calidad extra. Excelente agarre en ambientes secos, húmedos y aceitosos. Proporciona un gran confort, ergonomía y transpirabilidad. Apto para el contacto con alimentos acuosos, alcohólicos y lácteos pero no apto para el uso con alimentos ácidos

Talla/Color	Negro.		€ / u.
	Ref.	Código	
6	21060049	5519/6	3,38
7	21060050	5519/7	
8	21060051	5519/8	
9	21060052	5519/9	
10	21060053	5519/10	



Guante de nylon®/Spandex recubierto de nitrilo en combinación con poliuretano de base acuosa con tecnología T-Touch®



Este innovador recubrimiento obtiene la flexibilidad y el tacto del poliuretano y la resistencia mecánica del nitrilo. Excelente agarre en entornos secos, húmedos y levemente aceitosos gracias a la tecnología T-Touch. Excelente resistencia a la abrasión, mayor durabilidad. Fabricado con componentes especialmente respetuosos con el medio ambiente. Ligero y flexible. Sin DMF.

Talla/Color	Azul.		€ / u.
	Ref.	Código	
7	1001530	H4115/7	6,29
8	1001531	H4115/8	
9	1001532	H4115/9	
10	1001533	H4115/10	



Guante tipo conductor de nitrilo foam con forro interior de Nylon® y ajuste con cinta elástica en la muñeca



Recubierto totalmente para una mayor estanqueidad. Cinta elástica en la muñeca para un mayor ajuste. Buena resistencia mecánica y durabilidad. Resistencia al calor por contacto [100°C durante 15"]. Proporciona un sólido agarre en entornos secos, ligeramente húmedos y aceitosos.



Talla/Color	Azul.		€ / u.
	Ref.	Código	
7	1001534	5115BL/7	8,09
8	1001535	5115BL/8	
9	1001536	5115BL/9	
10	1001537	5115BL/10	

Guante de nitrilo foam con forro interior de Nylon® de tejido polar y ajuste con tira de velcro en la muñeca



Buena resistencia a la abrasión, mayor durabilidad. Resistencia al calor por contacto [250°C durante 15 segundos]. Forro polar interior de nylon que para mantener las manos estables en ambientes de frío hasta 0°C. La tecnología Foam de nitrilo, le confiere un tacto esponjoso y superior con un buen agarre en entornos secos y húmedos. Muy ergonómico. Óptimo ajuste gracias al velcro.



Talla/Color	Negro.		€ / u.
	Ref.	Código	
7	1001538	H5115W/7	11,64
8	1001539	H5115W/8	
9	1001540	H5115W/9	
10	1001541	H5115W/10	

“Agility Dry” Guante de nylon con doble recubrimiento de nitrilo, acabado rugoso Waves.



Inmejorable estanqueidad. Primer recubrimiento de nitrilo estanco y segundo en nitrilo foam con acabado rugoso “Waves”, que proporciona una excelente resistencia a la abrasión y una mayor durabilidad en entornos secos, húmedos o aceitados. La función higienizante Sanitized® protege los guantes de la formación de hongos, ácaros y bacterias, evita los olores, proporciona una protección duradera a los polímeros y minimiza la irritación de la piel.



Talla/Color	Azul/negro.		€ / u.
	Ref.	Código	
7	907910	5114/7	9,39
8	907911	5114/8	
9	907912	5114/9	
10	907913	5114/10	
11	907914	5114/11	

Mitón de cuero sintético y refuerzo extra en palma y dorso de elastano [spandex].



Refuerzo en palma, protección extra y mayor durabilidad. Cierre velcro para mayor ajuste. Dedos abiertos para una mayor tactilidad. Tejido vulvizo en pulgar para limpiar la sudoración. Tira en los dedos para facilitar la extracción. Flexible, cómodo y transpirable



Talla/Color	Negro.		€ / u.
	Ref.	Código	
8	8001216	H283/8	13,16
9	8001217	H283/9	
10	8001218	H283/10	

07

Guante de Nylon® + fibra Lycra® sin costuras con recubrimiento de nitrilo foam en palma



Muy ligero y flexible. Se adapta muy bien a la mano gracias a la fibra Lycra®. Excelente agarre en superficies secas, húmedas, aceitadas o grasientas.

Talla/Color	Rojo/negro.		€/ u.
	Ref.	Código	
6	8001243	111801/6	3,15
7	8001244	111801/7	
8	8001245	111801/8	
9	8001246	111801/9	
10	8001247	111801/10	



Guante de nylon® recubierto de poliuretano en palma.



Poliuretano de calidad extra. No desprende pelusa. Ideal para tareas de precisión en aplicaciones en seco o con presencia moderada de grasas o líquidos. Muy flexible.

Talla/Color	Azul.		€/ u.
	Ref.	Código	
6	8001202	H4114/6	2,70
7	8001203	H4114/7	
8	8001204	H4114/8	
9	8001205	H4114/9	
10	8001206	H4114/10	



Guante de poliéster con recubrimiento de poliuretano en palma



Poliuretano de calidad extra. No desprende pelusa. Tecnología Smart-Tip® especial para el uso de dispositivos táctiles.

Talla/Color	Azul.		€/ u.
	Ref.	Código	
7	8001212	H4119/7	2,25
8	8001213	H4119/8	
9	8001214	H4119/9	
10	8001215	H4119/10	



Guante HPPE con fibra de vidrio e hilo de acero recubierto de nitrilo arenoso. Refuerzo entre el pulgar y el índice. Galga 13. Táctil.



Refuerzo entre el pulgar y el índice que aporta mayor resistencia al desgaste y la rotura. Buen agarre en ambientes secos, húmedos y aceitados. Excelente resistencia a la abrasión. Mayor durabilidad. Apto para uso de dispositivos táctiles.

Talla/Color	Azul.		€/ u.
	Ref.	Código	
6	21060054	H4211RF/6	8,26
7	21060055	H4211RF/7	
8	21060056	H4211RF/8	
9	21060057	H4211RF/9	
10	21060058	H4211RF/10	
11	21060059	H4211RF/11	



Guante de nylon® con doble recubrimiento de nitrilo acabado arenoso. Refuerzo entre el pulgar y el índice. Táctil. Galga 15



Gran flexibilidad y confort. Refuerzo entre el pulgar y el índice que aporta mayor resistencia al desgaste y la rotura. Recubierto total con una primera capa de nitrilo estanco y la segunda capa de nitrilo arenoso en la palma que proporciona un mayor agarre en entornos secos, húmedos y aceitados. El nitrilo ofrece un mayor agarre en aceite que cualquier otro recubrimiento. Resistente al calor por contacto, 100° C durante 15 segundos. Excelente resistencia a la abrasión, mayor durabilidad. Apto para dispositivos táctiles.



Talla/Color	Negro.		€ / u.
	Ref.	Código	
6	21060060	H5520RF/6	6,19
7	21060061	H5520RF/7	
8	21060062	H5520RF/8	
9	21060063	H5520RF/9	
10	21060064	H5520RF/10	
11	21060065	H5520RF/11	

Guante de poliéster con doble recubrimiento de nitrilo



Soporte sin costuras que aporta confort y tacto. Totalmente recubierto, fabricado con una primera capa de nitrilo estanco y una segunda capa de nitrilo arenoso que confiere un excelente agarre en entornos húmedos, secos y ligeramente aceitados. Su doble recubrimiento de nitrilo aporta máxima resistencia a la abrasión, mayor durabilidad e impermeabilidad.



Talla/Color	Naranja/negro.		€ / u.
	Ref.	Código	
6	21060066	5116FC/6	3,20
7	21060067	5116FC/7	
8	21060068	5116FC/8	
9	21060069	5116FC/9	
10	21060070	5116FC/10	
11	21060071	5116FC/11	

Guante HPPE mezclado con otras fibras sintéticas recubierto de PU. Sin costuras. Antiestático.



Proporciona un TACTO EXTRA, ligereza y flexibilidad. Sensación de frescura por su GRAN TRANSPIRABILIDAD. Excelente agarre en entornos secos, ligeramente húmedos y aceitosos. TODOS LOS DEDOS SON TÁCTILES para facilitar el trabajo con pantallas. Guante de protección DISIPADOR DE CARGAS ELECTROSTÁTICAS para minimizar el riesgo de explosiones en zonas con atmósferas inflamables o explosivas.



Talla/Color	Gris.		€ / u.
	Ref.	Código	
6	21060072	4422/6	6,42
7	21060073	4422/7	
8	21060074	4422/8	
9	21060075	4422/9	
10	21060076	4422/10	
11	21060077	4422/11	

Guante Fibra ATA recubierto de nitrilo Microfinish®. Resistente al calor por contacto 250° C.



Gran resistencia a la abrasión, mayor durabilidad. Tecnología Microfinish®: sus ventosas microscópicas crean un vacío, dispersando el aceite y otros fluidos para que la superficie de agarre quede limpia y sea más segura. Excelente agarre en superficies secas, húmedas y aceitadas. Ofrece un máximo confort, tacto y flexibilidad que hace que sea como una segunda piel, aumenta la destreza y reduce la fatiga de las manos. Resistente al calor por contacto 250°C durante 15 segundos. Transpirable. El soporte sin costuras ATA® mantiene las manos frescas y ofrece una excelente flexibilidad para minimizar la fatiga de la mano aumentando la productividad.



Talla/Color	Amarillo.		€ / u.
	Ref.	Código	
8	21060078	534/8	14,91
9	21060079	534/9	
10	21060080	534/10	

Guante HPPE mezclado con otras fibras sintéticas recubierto de nitrilo con tecnología T-Touch™ y PU de base acuosa. Sin costuras.



Recubrimiento de BIPOLÍMERO con el que se obtiene la flexibilidad del poliuretano y la resistencia mecánica del nitrilo. Excelente resistencia a la abrasión lo que le aporta una MAYOR DURABILIDAD. EXCELENTE AGARRE en superficies húmedas, aceitadas y secas. Resistente al CALOR POR CONTACTO (100°C durante 15 segundos). REFUERZO ENTRE EL PULGAR Y EL ÍNDICE para aquellos trabajos donde haya más desgaste en esta zona.



Talla/Color	Gris.		€ / u.
	Ref.	Código	
6	21060081	4428/6	11,32
7	21060082	4428/7	
8	21060083	4428/8	
9	21060084	4428/9	
10	21060085	4428/10	
11	21060086	4428/11	

Guante HPPE recubierto de nitrilo estanco en palma. Sin costuras. Puño elástico.



Sin costuras. Especial para trabajos agresivos donde tenga contacto con aceites o grasas y alto riesgo de corte. Gran resistencia a la abrasión. Buenos niveles mecánicos. Excelente agarre en ambientes secos, húmedos y aceitosos. Ofrece una gran transpirabilidad, ligereza y flexibilidad



Talla/Color	Gris.		€ / u.
	Ref.	Código	
7	21060087	KSCN500/7	6,06
8	21060088	KSCN500/8	
9	21060089	KSCN500/9	
10	21060090	KSCN500/10	

Guante Látex flocado interior de algodón. Grosor 1 mm.



EXTRA GRUESO para mayor protección. Flocado interior de algodón para absorber el sudor y proveer al usuario de un mayor confort. Patrón antideslizante para un óptimo agarre en ambientes húmedos y secos. Clorinado para una mayor resistencia a sustancias químicas. Aditivos bacteriostáticos y fungicidas.



Talla/Color	Naranja.		€ / u.
	Ref.	Código	
7	21060091	621C/7	3,58
8	21060092	621C/8	
9	21060093	621C/9	
10	21060094	621C/10	

Guante de PVC sobre soporte de algodón sin costuras. Superficie arenosa. Largo 30 cm. Antiestático.



Totalmente estanco gracias al recubrimiento de PVC de triple capa. Buena resistencia a la abrasión por lo que ofrece una gran durabilidad. Muy flexible, hace que el guante sea muy cómodo, mayor flexibilidad que un guante de PVC habitual. Excelente agarre en situaciones secas, húmedas y aceitadas gracias a su acabado arenoso. Forro interior de algodón que absorbe el sudor. Resistente al calor por contacto 100° durante 15 segundos. Guante con propiedades electrostáticas, certificado bajo la norma EN16350:14.



Talla/Color	Negro.		€ / u.
	Ref.	Código	
8	21060095	5683/8	9,01
9	21060096	5683/9	
10	21060097	5683/10	
11	21060098	5683/11	

Guante de PVC sobre soporte de algodón sin costuras. Superficie arenosa. Largo 30 cm.



Totalmente estanco gracias al recubrimiento de PVC de triple capa. Buena resistencia a la abrasión por lo que ofrece una gran durabilidad. Muy flexible, hace que el guante sea muy cómodo, mayor flexibilidad que un guante de PVC habitual. Excelente agarre en situaciones secas, húmedas y aceitadas gracias a su acabado arenoso. Forro interior de algodón que absorbe el sudor. Resistente al calor por contacto 100° durante 15 segundos. Guante con propiedades electrostáticas, certificado bajo la norma EN16350:14.



Talla/Color	Naranja.		€ / u.
	Ref.	Código	
9	21060099	5681/9	22,37
10	21060100	5681/10	

Guante piel sintética transpirable con dorso de elastano. Refuerzo en palma. Cierre de velcro. Índice, anular y pulgar abiertos



Este nuevo modelo sustituye a la referencia H273V mejorando sus prestaciones con tres dedos abiertos en lugar de dos. Cierre con cinta en el puño ajustable. Dedos, pulgar, índice y corazón abiertos para una mayor destreza. Palma de piel sintética que aporta transpirabilidad. Dorso de elastano que proporciona una mayor flexibilidad. Refuerzos de PVC en la palma para una durabilidad extra. Se comercializa con blíster individual para punto de venta.



Talla/Color	Marrón/negro.		€ / u.
	Ref.	Código	
8	21060101	H273K/8	11,58
9	21060102	H273K/9	
10	21060103	H273K/10	

Guante piel sintética transpirable con dorso de elastano. Refuerzo en palma. Transpirable. Táctil



Cierre con cinta ajustable en el puño. Dedos pulgar, corazón e índice táctiles para el uso de pantallas. Acolchado Foam en nudillos para mayor protección de golpes. Cómodo y transpirable. Palma de piel sintética que aporta transpirabilidad. Refuerzos de PVC en la palma para un agarre y resistencia a la abrasión extra.



Talla/Color	Marrón/negro.		€ / u.
	Ref.	Código	
8	21060104	H282/8	12,75
9	21060105	H282/9	
10	21060106	H282/10	

Guante fibra ingenia con recubrimiento de nitrilo NFT PREMIUM. Galga 15. Calor por contacto 100°C. Táctil.



Excelente destreza: Uso en aplicaciones donde se requiera precisión. Muy elástico y confortable. La fibra Ingenia es un hilo ecológico fabricado a través de un proceso biotecnológico. Contiene un 37% de ingredientes de fuentes renovables y en su producción requiere un 30% menos de energía que los polímeros comúnmente utilizados, reduciendo a su vez un 63% menos de emisiones de CO2. Ofrece una excelente transpirabilidad absorbiendo rápidamente la humedad y expulsándola de la mano, por lo que confiere un gran confort. Excelente agarre en situaciones aceitosas y secas. La función higienizante Sanitized® protege los guantes de la formación de hongos, ácaros y bacterias, evita los olores, proporciona una protección duradera a los polímeros y minimiza la irritación de la piel. Resistente al calor por contacto nivel 1 (100°C a 15 segundos). Resistente al cloro y los rayos UV. Apto para uso de dispositivos táctiles (dedos pulgar e índice).



Talla/Color	Negro.		€ / u.
	Ref.	Código	
6	21060113	5111PLUS/6	4,30
7	21060114	5111PLUS/7	
8	21060115	5111PLUS/8	
9	21060116	5111PLUS/9	
10	21060117	5111PLUS/10	
11	21060118	5111PLUS/11	

Guante de poliéster recubierto con refuerzos de látex espumoso. Guante certificado para antivibración.



Sin costuras, Color oscuro para ambientes más sucios. Refuerzos de espuma de látex en la palma para reducir los efectos de los impactos y vibraciones. Certificado bajo la norma ENISO10819:2013+A1:2019 para vibraciones mecánicas y choques.



Talla/Color	Negro.		€/ u.
	Ref.	Código	
8	21060158	H223VR/8	12,97
9	21060159	H223VR/9	
10	21060160	H223VR/10	
11	21060161	H223VR/11	

Guante de poliéster/algodón recubierto de látex rugoso en palma y dedo pulgar. Galga 10



Ofrece una gran flexibilidad y buena resistencia a la abrasión. Proporciona un sólido agarre en entornos secos y húmedos. Dedo pulgar recubierto para una protección adicional (zona de mayor desgaste).



Talla/Color	Amarillo/azul.		€/ u.
	Ref.	Código	
6	21060166	H5300/6	3,93
7	21060167	H5300/7	
8	21060168	H5300/8	
9	21060169	H5300/9	
10	21060170	H5300/10	

Guante de nylon recubrimiento nitrilo FOAM y dots de nitrilo en palma



Guante tipo ligero muy versátil, con excelente adaptación del soporte a la mano y recubrimiento reforzado por elemento antideslizante. Dicha unión en su configuración permite realizar trabajos varios con la máxima destreza y agarre. Recubrimiento nitrilo esponjoso (tipo foam) antideslizante y dots de nitrilo con soporte de nylon sin costuras. Muy buena resistencia a la abrasión. Alta dexteridad y confort. Diseño ergonómico. Extraordinario agarre. Propiedades antideslizantes sobre superficies. Certificado Oeko-Tex® Standard 100



Talla/Color	Naranja.		€/ u.
	Ref.	Código	
11	1002025	WX-666/6	3,69
7	1002026	WX-666/7	
8	1002027	WX-666/8	
9	1002028	WX-666/9	
10	1002029	WX-666/10	

Guante de nylon sin costuras con recubrimiento nitrilo



Guante de especial tecnología con soporte de nylon sin costuras. Totalmente descubierto en el dorso para una máxima ventilación. Excelente dexteridad, sensibilidad y agarre en seco y húmedo. Diseño especial para que tenga el máximo ajuste a la mano. Gran resistencia a la abrasión y buen comportamiento al corte, desgarrar y perforación. Certificado Oeko-Tex® Standard 100



Talla/Color	Gris.		€/ u.
	Ref.	Código	
6	1002355	SN-349/6	2,31
7	1002356	SN-349/7	
8	1002357	SN-349/8	
9	1002358	SN-349/9	
10	1002359	SN-349/10	

Guante latex natural, soporte nylon sin costuras



Guante con soporte de Nylon sin costuras recubierto en palma y uñeros con látex natural. Totalmente descubierto en el dorso para una máxima ventilación. Excelente dexteridad, sensibilidad y agarre en seco y húmedo. Buena resistencia a la abrasión y buen comportamiento al corte, desgarrar y perforación.

Talla/Color	Amarillo/negro.		€ / u.
	Ref.	Código	
6	1002365	SL-010/6	2,62
7	1002366	SL-010/7	
8	1002367	SL-010/8	
9	1002368	SL-010/9	
10	1002369	SL-010/10	



Guante piel flor cabra en palma, dorso algodón y cierre velcro



Guante con palma piel flor de cabra en color natural con grueso de 0.7mm a 0.8mm. Refuerzo del mismo material en dedos pulgar e índice, así como en uñeros. Dorso, aireado de tejido algodón 100%. Puño elástico con cierre por velcro. Excelente tacto y confort

Talla/Color	Natural/naranja.		€ / u.
	Ref.	Código	
8	8001616	EGP-011/8	3,51
9	8001617	EGP-011/9	
10	8001618	EGP-011/10	



Guante piel flor vacuno de 0,08-1,00 mm grosor, ajuste elastico y puño ribeteado



Guante de piel flor vacuno de color natural y grueso de 0,7 mm. a 0,8 mm. Ajuste elástico en la muñeca y puño ribeteado.

Talla/Color	Gris.		€ / u.
	Ref.	Código	
7	8001619	GP-016C/7	3,22
8	8001620	GP-016C/8	
9	8001621	GP-016C/9	
10	8001622	GP-016C/10	
11	8001623	GP-016C/11	



Guante americano serraje de selección media. Forrado palma, dorso y manguito en algodón



Versión económica. Refuerzos en nudillos y uñeros de serraje. Forrado interior en la palma.

Talla/Color	Azul/gris.		€ / u.
	Ref.	Código	
9	1001617	404B/9	4,30
10	1001618	404B/10	



Guante americano serraje crupón cuellos vacuno. Reforzado palma, pulgar e índice con serraje



Calidad extra. Refuerzo de serraje en nudillos, uñeros, pulgar y palma para mayor durabilidad. Excelente resistencia a la abrasión y al corte. Flexible. Forrado en palma. Manguito de seguridad fabricado en Iona.

Talla/Color	Gris/verde.		€ / u.
	Ref.	Código	
8	1001619	404ARPC/8	9,05
9	1001620	404ARPC/9	
10	1001621	404ARPC/10	



Guante cuero flor vacuno, dorso interlock. Elástico de apriete en la muñeca



Piel de calidad extra, adecuada para aquellos trabajos donde se requiera tacto. Elástico en la muñeca para una mejor sujeción.

Talla/Color	Naranja/gris.		€ / u.
	Ref.	Código	
6	1001622	416/6	7,41
7	1001623	416/7	
8	1001624	416/8	
9	1001625	416/9	
10	1001626	416/10	



Guante conductor piel flor vacuno natural



Pulgar de ala. Versión económica. Ofrece un buen tacto y transpirabilidad. Calor por contacto (100°C durante 15").

Talla/Color	Natural.		€ / u.
	Ref.	Código	
7	1001627	406VRW/7	4,15
8	1001628	406VRW/8	
9	1001629	406VRW/9	
10	1001630	406VRW/10	



Guante conductor piel flor vacuno amarillo



Pulgar de ala. Versión económica. Ofrece un buen tacto y transpirabilidad. Calor por contacto (100°C durante 15").

Talla/Color	Natural.		€ / u.
	Ref.	Código	
7	1001631	406VR2°/7	5,75
8	1001632	406VR2°/8	
9	1001633	406VR2°/9	
10	1001634	406VR2°/10	



Guante cuero sintético con Spandex®. Cierre velcro. Color gris



Refuerzo acolchado en palma y nudillos para protección de golpes. Cierre con velcro para mayor ajuste. Flexible, cómodo y transpirable. Disponible en 6 colores (BL/GY/NR/R/V/Y).

Talla/Color	Gris.		€ / u.
	Ref.	Código	
8	1001635	H270GY/8	14,94
9	1001636	H270GY/9	
10	1001637	H270GY/10	



Guante cuero sintético con Spandex®. Cierre velcro. Color rojo



Refuerzo acolchado en palma y nudillos para protección de golpes. Cierre con velcro para mayor ajuste. Flexible, cómodo y transpirable. Disponible en 6 colores (BL/GY/NR/R/V/Y).

Talla/Color	Rojo.		€ / u.
	Ref.	Código	
9	1001638	H270R/9	14,94
8	1001639	H270R/8	
10	1001640	H270R/10	



Guante serraje americano con refuerzo de serraje en palma, pulgar e índice



Versión económica. Refuerzo extra en palma y pulgar para mayor durabilidad. Su grosor ofrece una buena protección a cortes y abrasión. Forrado en la palma.

Gris/verde.		€ / u.
Ref.	Código	
1001642	404X	5,28



Guante cuero flor cabra, dorso interlock, puño elástico de algodón



Versión económica. La piel de cabra es la más adecuada para aquellos trabajos donde se requiera tacto. Con puño para un mejor ajuste.

Talla/Color	Gris.		€ / u.
	Ref.	Código	
6	1001643	418/6	5,03
7	1001644	418/7	
8	1001645	418/8	
9	1001646	418/9	
10	1001647	418/10	



Guante cuero sintético con Spandex®. Cierre velcro



Refuerzo acolchado en palma y nudillos para protección de golpes. Cierre con velcro para mayor ajuste. Flexible, cómodo y transpirable. Disponible en 6 colores [BL/GY/NR/R/V/Y].



H270Y/8

H270BL/8

H270NR/8

H270V/8

Talla/Color	Amarillo.		Azul.		Naranja.		Verde.		€ / u.
	Ref.	Código	Ref.	Código	Ref.	Código	Ref.	Código	
8	1001648	H270Y/8	1001651	H270BL/8	1001654	H270NR/8	1001657	H270V/8	14,94
9	1001649	H270Y/9	1001652	H270BL/9	1001655	H270NR/9	1001658	H270V/9	
10	1001650	H270Y/10	1001653	H270BL/10	1001656	H270NR/10	1001659	H270V/10	

Flor vacuno gris. Ribete de tela. Grosor 0,7-0,9 cm.



Talla/Color	Gris.		€ / u.
	Ref.	Código	
7	1001676	160IBSZ-7	3,18
8	1001677	160IBSZ-8	
9	1001678	160IBSZ-9	
10	1001679	160IBSZ-10	
11	1002415	160IBSZ-11	



Serraje vacuno gris. Forro en palma. Refuerzo serraje verde en palma, pulgar e índice. Grosor: 1,1-1,3 mm. Cartera blanca engomada.



Talla/Color	Gris.		€ / u.
	Ref.	Código	
9	1002416	202VB-9	4,25
10	1002417	202VB-10	



Flor Cabra Gris.0,5-0,9MM.Dorso algodón.Puño elastico.



Talla/Color	Gris.		€/ u.
	Ref.	Código	
6	8002102	AC56B-6	2,41
7	8002103	AC56B-7	
8	8002104	AC56B-8	
9	8002105	AC56B-9	
10	8002106	AC56B-10	



Guante de poliester sin costuras con recubrimiento de PU



Guante con muy buena resistencia a la abrasión y al desgarro. Diseño ergonómico que facilita su alta dexteridad. Descubierta en el dorso para facilitar la aireación de la mano.

Talla/Color	Negro.		€/ u.
	Ref.	Código	
6	8001624	S-2000/6	1,20
7	8001625	S-2000/7	
8	8001626	S-2000/8	
9	8001627	S-2000/9	
10	8001628	S-2000/10	



Guante de nitrilo con soporte sin costuras



Soporte de nylon sin costuras. Recubrimiento flexible de nitrilo. Sobresaliente ajuste del guante sobre la mano. Excelente resistencia al desgarro y la abrasión. Exclusivo acabado para agarre máximo en seco Gran tacto para el manejo de componentes. Certificado Oeko-Tex® Standard 100

Talla/Color	Amarillo/negro.		€/ u.
	Ref.	Código	
6	8001605	ED-110/6	2,78
7	8001606	ED-110/7	
8	8001607	ED-110/8	
9	8001608	ED-110/9	
10	8001609	ED-110/10	



Guante de nylon sin costuras con nitrilo microporoso



Guante de nitrilo esponjoso (tipo foam) antideslizante con soporte de nylon sin costuras. Excelente resistencia a la abrasión. Alta dexteridad y confort. Diseño ergonómico. Extraordinario agarre. Propiedades antideslizantes sobre superficies aceitadas. Certificado Oeko-Tex® Standard 100

Talla/Color	Negro.		€/ u.
	Ref.	Código	
6	8001611	SN-1001/6	3,05
7	8001612	SN-1001/7	
8	8001613	SN-1001/8	
9	8001614	SN-1001/9	
10	8001615	SN-1001/10	



Guante de poliester Rojo



Guante con soporte sin costuras fabricado en poliéster de color rojo. Recubrimiento rugoso de látex natural en color negro. Buena resistencia a la abrasión y desgarro. Extra flexible. Perfecto ajuste a la mano y excelente dexteridad con dedos anatómicos. Totalmente descubierta en el dorso para una máxima ventilación. Excelente dexteridad, sensibilidad y agarre en seco y húmedo.

Talla/Color	Rojo.		€/ u.
	Ref.	Código	
7	21002001	ESL-010/7	1,54
8	21002002	ESL-010/8	
9	21002003	ESL-010/9	
10	21002004	ESL-010/10	





Guante de poliéster , con recubrimiento de nitrilo

Guante sin costuras realizado en poliéster con recubrimiento de nitrilo en la palma. Gran resistencia a la abrasión. Excelente dexteridad, sensibilidad y agarre en seco y húmedo. Diseño especial para que tenga el máximo ajuste a la mano.

Talla/Color	Gris/verde oscuro.		€ / u.
	Ref.	Código	
6	21002006	SH-349R/6	1,05
7	21002007	SH-349R/7	
8	21002008	SH-349R/8	
9	21002009	SH-349R/9	
10	21002010	SH-349R/10	



Guante de poliéster negro sin costuras. Recubrimiento nitrilo negro en palma. Galga 13. Puño elástico.



Talla/Color	Negro.		€ / u.
	Ref.	Código	
7	1002423	700NG2P TOUCH-7	0,99
8	1002424	700NG2P TOUCH-8	
9	1002425	700NG2P TOUCH-9	
10	1002426	700NG2P TOUCH-10	



Guante de nylon gris con Kevlar sin costuras. Recubrimiento poliuretano gris en palma. Galga 13. Puño elástico.



Talla/Color	Gris.		€ / u.
	Ref.	Código	
6	1002432	500NEVERCUT-6	2,16
7	1001706	500NEVERCUT-7	
8	1001707	500NEVERCUT-8	
9	1001708	500NEVERCUT-9	
10	1001709	500NEVERCUT-10	



Guante 100% Nylon con fibras de carbono y Licra. Galga 18. Recubrimiento Pu



Talla/Color	Azul.		€ / u.
	Ref.	Código	
6	8002133	718STAC-6	5,15
7	8002134	718STAC-7	
8	8002135	718STAC-8	
9	8002136	718STAC-9	
10	8002137	718STAC-10	
11	8002138	718STAC-11	



Guante de poliéster rojo sin costuras. Recubrimiento látex rugoso negro en palma



Talla/Color	Rojo/negro.		€ / u.
	Ref.	Código	
7	8002147	320P-7	1,53
8	8002148	320P-8	
9	8002149	320P-9	
10	8002150	320P-10	



Guante de poliéster fibra sintética muy resistente a la abrasión



Poliéster fibra sintética muy resistente a la abrasión. Menor elasticidad y absorción de sudoración que la poliamida. Sin costuras proporciona mayor comodidad y evita las irritaciones. Recubrimiento de poliuretano material sintético de excelente elasticidad y destreza. Proporciona un alto nivel de resistencia a la abrasión.

Ref.	Código	Color	Talla	€ / u.
2401983	500NG2P-6	Negro	6	0,95
2401984	500NG2P-7	Negro	7	0,95
2401985	500NG2P-8	Negro	8	0,95
2401986	500NG2P-9	Negro	9	0,95
2401987	500NG2P-10	Negro	10	0,95



Guante de poliéster fibra sintética muy resistente a la abrasión



Poliéster fibra sintética muy resistente a la abrasión. Menor elasticidad y absorción de sudoración que la poliamida. Sin costuras proporciona mayor comodidad y evita las irritaciones. Recubrimiento de poliuretano material sintético de excelente elasticidad y destreza. Proporciona un alto nivel de resistencia a la abrasión.

Ref.	Código	Color	Talla	€ / u.
2401988	5002P-6	Negro	6	0,95
2401989	5002P-7	Negro	7	0,95
2401990	5002P-8	Negro	8	0,95
2401991	5002P-9	Negro	9	0,95
2401992	5002P-10	Negro	10	0,95
2401993	5002P-11	Negro	11	0,95



Guante de nylon APTO PARA PANTALLAS TÁCTILES



APTO PARA PANTALLAS TÁCTILES. Nailon (poliamida) Fibra sintética muy resistente a la abrasión. No se deforma y seca rápidamente. Sin costuras proporciona mayor comodidad y evita las irritaciones. Galga 18 proporciona un alto de sensibilidad para trabajos de gran precisión. Recubrimiento de poliuretano material sintético de excelente elasticidad y destreza. Proporciona un alto nivel de resistencia a la abrasión. Disponible con marcado tinta.

Talla/Color	Azul.		€ / u.
	Ref.	Código	
6	2401994	500FINE-6	2,67
7	2401995	500FINE-7	
8	2401996	500FINE-8	
9	2401997	500FINE-9	
10	2401998	500FINE-10	



Guante soporte nylon rojo sin costuras. Recubrimiento nitrilo micro finish negro en palma. Puño elástico. Galga 15.



Nailon y elastano. Ambos materiales combinados proporcionan al guante ergonomía y confort. Reduce el esfuerzo muscular del usuario minimizando la fatiga de la mano e incrementando la productividad del operario. Recubrimiento nitrilo Sandy grip. Aporta gran resistencia mecánica, comodidad y destreza sin sacrificar la durabilidad del guante. Proporciona un gran agarre en situación húmeda o seca. Ajuste elástico en muñeca. Ofrece al EPI un ajuste adecuado a la muñeca evitando que se mueva de la mano.

Talla/Color	Rojo.		€ / u.
	Ref.	Código	
6	20006795	700RMF TOUCH-6	3,05
7	20006796	700RMF TOUCH-7	
8	20006797	700RMF TOUCH-8	
9	20006798	700RMF TOUCH-9	
10	20006793	700RMF TOUCH-10	
11	20006794	700RMF TOUCH-11	



Guante de Nitrilo: caucho sintético de gran flexibilidad, ductilidad



Nitrilo: caucho sintético de gran flexibilidad, ductilidad. Resistente aceites y lubricantes. Poliéster fibra sintética con gran resistencia a la abrasión. Menos elasticidad y absorción de la sudoración que el nylon. El soporte sin costuras nos proporciona ergonomía y no provoca fatiga. Nitrilo versión económica.

Talla/Color	Blanco/gris.		€ / u.
	Ref.	Código	
6	2401999	700GP TOUCH-6	0,99
7	2402000	700GP TOUCH-7	
8	2402001	700GP TOUCH-8	
9	2402002	700GP TOUCH-9	



Guante soporte HDPC, fibra de vidrio y nailon azul sin costuras. Recubrimiento nitrilo micro finish negro en palma. Refuerzo entre pulgar e índice. Puño elástico. Galga 13.



Interior HDPC. Mejora el confort proporcionando un tacto agradable y suave a la mano. Las fibras de vidrio no están en contacto directo con la mano, minimizando el riesgo de alergias. Las fibras de corte en la base retrasa el desprendimiento de los cubrimientos. El refuerzo entre pulgar e índice confiere mayor durabilidad al EPI. Recomendamos este producto en trabajos que producen mucha abrasión por piezas cortantes en esta zona. Desteridad 5 (mínimo 0, máximo 5) Lavado a temperatura máxima de 40° C. N° de ciclos de lavado: 10.

Talla/Color	Azul/negro.		€ / u.
	Ref.	Código	
5	20006929	413RF TFLN-5	6,38
6	20006930	413RF TFLN-6	
7	20006931	413RF TFLN-7	
8	20006932	413RF TFLN-8	
9	20006933	413RF TFLN-9	
10	20006927	413RF TFLN-10	
11	20006928	413RF TFLN-11	



Guante soporte HPPE rojo, fibra de acero y fibra de vidrio sin costuras. Recubrimiento de nitrilo foam negro en palma. Acabado arpón antideslizante de nitrilo en palma. Puño elástico. Galga 13. EFICAZ EN PANTALLAS TÁCTILES



HPPE. Fibra sintética de gran resistencia a abrasión y tenacidad. Entre sus propiedades destacan el alto nivel de protección a corte y durabilidad del EPI. Fibras de acero y fibras de vidrio. Confieren al guante de mayor protección a corte. Alcanzando en laboratorio nivel F en la prueba TDM. Acabado arpón antideslizante en palma. Dota al EPI de mayor agarre. Minimiza la fatiga muscular en operaciones que requieren gran esfuerzo para manipular piezas engrasadas o mojadas. Al acabado arpón favorece la evacuación de los líquidos.

Talla/Color	Rojo.		€ / u.
	Ref.	Código	
10	20006906	486F GRIP-10	11,27
6	20006907	486F GRIP-6	
7	20006908	486F GRIP-7	
8	20006909	486F GRIP-8	
9	20006910	486F GRIP-9	



Guante de poliéster y elastano amarillo flúor con recubrimiento de nitrilo foam en palma



Color flúor para aumentar la visibilidad de las manos en zonas de escasa visibilidad. Espuma de nitrilo ofrece protección frente a aceites y grasas y aporta flexibilidad y destierzo. Agarre en superficies aceitosas, húmedas y secas

Talla/Color	Amarillo flúor/negro.		€ / u.
	Ref.	Código	
6	2402004	H1118HV/6	3,77
7	2402005	H1118HV/7	
8	2402006	H1118HV/8	
9	2402007	H1118HV/9	
10	2402008	H1118HV/10	
11	2402009	H1118HV/11	



Guante disipador de cargas electroestáticas fabricado en poliéster y fibra de carbono recubierto de poliuretano en palma



Soporte sin costuras de galga 13 que aporta tacto, ligereza, flexibilidad y confort. Se adapta muy bien a la mano. Su recubrimiento de poliuretano elástico ofrece un óptimo agarre en superficies secas, ligeramente aceitosas y húmedas



Talla/Color	Gris/blanco.		€/ u.
	Ref.	Código	
6	2402010	PU1000/6	1,39
7	2402011	PU1000/7	
8	2402012	PU1000/8	
9	2402013	PU1000/9	
10	2402014	PU1000/10	
11	2402015	PU1000/11	

Guante HPPE mezclado con Kevlar® y elastano recubierto de nitrilo foam en la palma y refuerzos TPR anti-impacto en el dorso



Refuerzo de nitrilo NFT entre el índice y pulgar para mayor resistencia a la abrasión. Agarre superior en ambientes aceitosos, secos y húmedos. Resistente al calor por contacto (100° C durante 15"). Certificado para protección contra impactos



Talla/Color	.		€/ u.
	Ref.	Código	
8	2402016	NR00/8	22,26
9	2402017	NR00/9	
10	2402018	NR00/10	
11	2402019	NR00/11	

Guante sin costuras de poliéster totalmente recubierto de nitrilo estanco



Diseño ergonómico sin costuras que aporta una mayor flexibilidad, tacto y confort. Ofrece una gran duración y es resistente al aceite y al agua. Totalmente impermeable gracias a su capa de nitrilo estanco que confiere además un buen agarre en entornos húmedos, mojados y aceitados



Talla/Color	Negro.		€/ u.
	Ref.	Código	
7	2402020	1151FC/7	2,30
8	2402021	1151FC/8	
9	2402022	1151FC/9	
10	2402023	1151FC/10	
11	2402024	1151FC/11	

Guante de nailon con doble recubrimiento de nitrilo /PU base acuosa



Refuerzo entre el pulgar y el índice que aporta mayor resistencia al desgaste y la rotura. Recubierto total con una primera capa de nitrilo estanco y la segunda capa de nitrilo arenoso en la palma que proporciona un mayor agarre en entornos secos, húmedos y aceitados



Talla/Color	Negro.		€/ u.
	Ref.	Código	
6	2402025	5520RF/6	6,19
7	2402026	5520RF/7	
8	2402027	5520RF/8	
9	2402028	5520RF/9	
10	2402029	5520RF/10	
11	2402030	5520RF/11	

Guante sin costuras de nailon / fibra lycra® con recubrimiento de nitrilo foam microporoso y puntos de nitrilo en la palma



Ligero y flexible, excelente adaptabilidad. Mayor agarre y durabilidad por los puntos de nitrilo en la palma. Resistente al calor por contacto (100 °C durante 15")

Talla/Color	Rojo/negro.		€ / u.
	Ref.	Código	
6	2402031	5112/6	4,81
7	2402032	5112/7	
8	2402033	5112/8	
9	2402034	5112/9	
10	2402035	5112/10	
11	2402036	5112/11	



Guante de poliéster/algodón reciclado recubierto de látex rugoso



La función higienizante Sanitized® protege los guantes de la formación de hongos, ácaros y bacterias, evita los olores, proporciona una protección duradera a los polímeros y minimiza la irritación de la piel. Resistente al calor por contacto (250°C durante 15")

Talla/Color	Verde.		€ / u.
	Ref.	Código	
7	2402037	H251NT/7	3,30
8	2402038	H251NT/8	
9	2402039	H251NT/9	
10	2402040	H251NT/10	
11	2402041	H251NT/11	



Guante de motorista de invierno de piel flor de cabra con refuerzos en palma y protección anti-impacto en el dorso



Refuerzos anti-impacto en el dorso que ayudan a amortiguar los golpes. Refuerzos antideslizantes en la palma para un agarre extra durante la conducción. Tecnología táctil en el dedo índice para dispositivos táctil. Forro interior de poliéster que aporta una gran calidez

Talla/Color	Negro.		€ / u.
	Ref.	Código	
7	2402042	H370/7	95,47
8	2402043	H370/8	
9	2402044	H370/9	
10	2402045	H370/10	
11	2402046	H370/11	



Guante de poliéster reciclado con spandex recubierto de látex arenoso en la palma



El soporte de poliéster proviene en un 49% de botellas de PET recicladas, por lo que su producción reduce la generación de residuos contribuyendo con el desarrollo de la economía circular. Ofrece una gran flexibilidad y un confort extra, adaptándose perfectamente a la mano.

Buena resistencia a la abrasión, mayor durabilidad

Talla/Color	Azul.		€ / u.
	Ref.	Código	
6	2402047	H265NT/6	3,73
7	2402048	H265NT/7	
8	2402049	H265NT/8	
9	2402050	H265NT/9	
10	2402051	H265NT/10	
11	2402052	H265NT/11	



Guante de poliéster con doble recubrimiento de nitrilo



Totalmente recubierto, fabricado con una primera capa de nitrilo estanco y una segunda capa de nitrilo arenoso que confiere un excelente agarre en entornos húmedos, secos y ligeramente aceitados. Su doble recubrimiento de nitrilo aporta máxima resistencia a la abrasión, mayor durabilidad e impermeabilidad



Talla/Color	Verde.		€/ u.
	Ref.	Código	
6	2402053	H5116FCV/6	3,73
7	2402054	H5116FCV/7	
8	2402055	H5116FCV/8	
9	2402056	H5116FCV/9	
10	2402057	H5116FCV/10	

Guante de piel flor de cabra con refuerzos en piel vacuno en palma y protección anti-impacto en dorso



Este guante es apto para su uso con dispositivos con pantalla táctil en el índice por lo que es mucho más cómodo al no tener que quitarse los guantes para utilizar este tipo de dispositivos. Los entrededos están fabricados de poliéster elástico para ofrecer una mayor comodidad y flexibilidad al guante. En su interior dispone de un forro ligero interior que aporta calidez



Talla/Color	Negro.		€/ u.
	Ref.	Código	
7	2402058	H360/7	53,52
8	2402059	H360/8	
9	2402060	H360/9	
10	2402061	H360/10	
11	2402062	H360/11	

Guante anticorte sin costuras



Guante Anticorte sin costuras realizado en PFG(Poliamida , poliester y fibra de vidrio)con recubrimiento PU en la palma .Maxima resistencia a la abrasion y desgarró .



Talla/Color	Gris.		€/ u.
	Ref.	Código	
6	2401978	WX-020/6	6,07
7	2401979	WX-020/7	
8	2401980	WX-020/8	
9	2401981	WX-020/9	
10	2401982	WX-020/10	

Guante anticorte de UHMWPE y poliamida, recubrimiento de PU



Guante sin costuras con soporte de tejido UHMWPE (Polietileno de ultra alto peso molecular). Recubrimiento especial de PU para aumentar resistencia mecánica. Alta resistencia a la abrasión, corte y desgarró. Gran dexteridad. Excelente agarre en seco y en húmedo



Talla/Color	Gris.		€/ u.
	Ref.	Código	
6	1002360	S-2004/6	6,84
7	1002361	S-2004/7	
8	1002362	S-2004/8	
9	1002363	S-2004/9	
10	1002364	S-2004/10	

Guante Dyneema® con palma y medio dorso cubierto de látex.



La fibra Dyneema® es un producto de alta tecnología que garantiza una excelente protección al corte. Proporciona un tacto extra, ligereza y flexibilidad. Lavable. Excelente agarre en ambientes secos y húmedos. Protección total en la zona cubierta. La función higienizante Sanitized® protege los guantes de la formación de hongos, ácaros y bacterias, evita los olores, proporciona una protección duradera a los polímeros y minimiza la irritación de la piel.

Talla/Color	Negro.		€ / u.
	Ref.	Código	
7	907920	4404HC/7	19,46
8	907921	4404HC/8	
9	907922	4404HC/9	
10	907923	4404HC/10	



Guante Dyneema® 3GY Tecnología Diamond® recubierto de PU en palma.



La tecnología Dyneema® Diamond no utiliza fibra de vidrio para incrementar los niveles de corte y evita que el usuario pueda tener alergias o irritaciones en la piel. Proporcionan un tacto excelente, ligereza y flexibilidad. Lavable. Sensación de frescura por su gran transpirabilidad. Buen agarre en ambientes secos, ligeramente húmedos o aceitados. Buena resistencia a la abrasión, mayor durabilidad.

Talla/Color	Jaspeado/gris.		€ / u.
	Ref.	Código	
7	907930	4408/7	25,17
8	907931	4408/8	
9	907932	4408/9	
10	907933	4408/10	
11	907934	4408/11	



Guante de nitrilo pesado sobre soporte de algodón. Azul. Dorso fresco. Puño elástico



Puño elástico para mejor ajuste. Estanqueidad total en las zonas cubiertas. La función higienizante Sanitized® protege los guantes de la formación de hongos, ácaros y bacterias, evita los olores, proporciona una protección duradera a los polímeros y minimiza la irritación de la piel.

Talla/Color	Azul.		€ / u.
	Ref.	Código	
M	1001546	9901/M	5,58
L	1001547	9901/L	



Guante Dyneema® blanco con fibra de vidrio y PU gris



La fibra Dyneema® es mundialmente conocida por su gran resistencia y se utiliza para la fabricación de guantes con protección al corte. Se pueden lavar a una temperatura de hasta 40°C. Proporciona un tacto extra, ligereza y flexibilidad. Sensación de frescura por su transpirabilidad. Gran resistencia a la abrasión, mayor durabilidad. Buen agarre en ambientes secos, ligeramente húmedos o aceitados. Apto para uso alimentario.

Talla/Color	Gris/blanco.		€ / u.
	Ref.	Código	
6	1001548	4400/6	21,46
7	1001549	4400/7	
8	1001550	4400/8	
9	1001551	4400/9	



07

Guante Dyneema® blanco con PU blanco



La fibra Dyneema® es mundialmente conocida por su gran resistencia y se utiliza para la fabricación de guantes con protección al corte. Se pueden lavar a una temperatura de hasta 90°C. Proporciona un tacto extra, ligereza y flexibilidad. Sensación de frescura por su transpirabilidad. Gran resistencia a la abrasión, mayor durabilidad. Buen agarre en ambientes secos, ligeramente húmedos o aceitados. La función higienizante Sanitized® protege los guantes de la formación de hongos, ácaros y bacterias, evita los olores, proporciona una protección duradera a los polímeros y minimiza la irritación de la piel.



Talla/Color	Blanco.		€/ u.
	Ref.	Código	
XS	1001552	DY004/XS	14,55
S	1001553	DY004/S	
M	1001554	DY004/M	
L	1001555	DY004/L	
XL	1001556	DY004/XL	

Guante Dyneema® gris con PU gris



La tecnología Dyneema® Diamond no utiliza fibra de vidrio para incrementar los niveles de corte y evita que el usuario pueda tener alergias o irritaciones en la piel. Proporcionan un tacto excelente, ligereza y flexibilidad. Lavable. Sensación de frescura por su gran transpirabilidad. Buen agarre en ambientes secos, ligeramente húmedos o aceitados. Excelente resistencia a la abrasión, mayor durabilidad.



Talla/Color	Gris.		€/ u.
	Ref.	Código	
XS	1001557	DY008SP/XS	13,12
S	1001558	DY008SP/S	
M	1001559	DY008SP/M	
XL	1001560	DY008SP/XL	
XXL	1001561	DY008SP/XXL	

Manguito anticorte con fibra kevlar®. 36 cm



El manguito debe usarse con un guante apropiado por encima. El ojal para el pulgar asegura que el manguito no se mueva ofreciendo mayor protección. Resistente al calor por contacto (100°C durante 15"). Su fibra 100% Kevlar proporciona una alta resistencia a cortes, desgarros y roces mientras mantiene un alto grado de comodidad para el usuario.



Talla/Color	Amarillo.		€/ u.
	Ref.	Código	
36	1001565	SKST/36	9,59

Flex 3 Cut Guante de nylon/abratex con palma PU



Gran resistencia a la abrasión, mayor durabilidad. Agarre preciso en superficies secas, ligeramente húmedas o aceitadas. Muy ergonómico y transpirable. La función higienizante Sanitized® protege los guantes de la formación de hongos, ácaros y bacterias, evita los olores, proporciona una protección duradera a los polímeros y minimiza la irritación de la piel.



Talla/Color	Gris/negro.		€/ u.
	Ref.	Código	
7	1001570	4383/7	11,15
8	1001571	4383/8	
9	1001572	4383/9	
10	1001573	4383/10	

Guante Dyneema® recubierto de látex total



La fibra Dyneema® es un producto de alta tecnología que garantiza una excelente protección al corte. Proporciona un tacto extra, ligereza y flexibilidad. Lavable. Excelente agarre en ambientes secos y húmedos. La función higienizante Sanitized® protege los guantes de la formación de hongos, ácaros y bacterias, evita los olores, proporciona una protección duradera a los polímeros y minimiza la irritación de la piel.



Talla/Color	Negro.		€ / u.
	Ref.	Código	
6	907915	4404/6	19,28
7	907916	4404/7	
8	907917	4404/8	
9	907918	4404/9	
10	907919	4404/10	

Fibra HPPE + fibra de vidrio gris sin costuras. Recubrimiento poliuretano gris en palma. Galga 13. Puño elástico.



Talla/Color	Gris.		€ / u.
	Ref.	Código	
6	1001695	401G2 DYN-6	3,99
7	1001696	401G2 DYN-7	
8	1001697	401G2 DYN-8	
9	1001698	401G2 DYN-9	
10	1001699	401G2 DYN-10	
11	1001705	401G2 DYN-11	



Guante riesgo por corte



Circunferencia exterior de la anilla 3 81 mm e interior 2 75 mm Proporciona protección frente a cortes y pinchazos de cuchillos de mano en industrias cárnicas, despiece enmataderos o cualquier otro trabajo que requiera este tipo de protección. Puño de ajuste en varios materiales Nailon, metálico y PVC. Malla de acero inoxidable evita el crecimiento de las bacterias en contacto con los alimentos. Se puede lavar y desinfectar utilizar productos permitidos por las autoridades de higiene alimentaria Dejar secar.



Ref.	Código	Talla	€ / u.
2402063	15PVC-5	5	148,70
2402064	15PVC-6	6	148,70
2402065	15PVC-7	7	148,70
2402066	15PVC-8	8	148,70
2402067	15PVC-9	9	148,70
2402068	15PVC-10	10	148,70

Guante resistente al corte con la nueva tecnología K-rock®, recubierto de poliuretano.



Soporte sin costuras con tecnología textil K-ROCK, que aporta tacto, ligereza, flexibilidad y confort. Sensación de frescura por su gran transpirabilidad. Tacto extra con un óptimo agarre en superficies secas y ligeramente húmedas. Refuerzo de nitrilo entre el pulgar y el índice que aporta mayor resistencia al desgaste y la rotura.



Talla/Color	Jaspeado/gris.		€ / u.
	Ref.	Código	
7	21060119	4570RF/7	4,91
8	21060120	4570RF/8	
9	21060121	4570RF/9	
10	21060122	4570RF/10	
11	21060123	4570RF/11	

Talla/Color	Gris.		€ / u.
	Ref.	Código	
6	21060124	4540RF/6	8,81
7	21060125	4540RF/7	
8	21060126	4540RF/8	
9	21060127	4540RF/9	
10	21060128	4540RF/10	
11	21060129	4540RF/11	

Guante resistente al corte con la nueva tecnología K-rock® mezclado con otras fibras sintéticas recubierto de PU en palma.



Ofrece elevados niveles de resistencia mecánica, buen agarre y tacto con altos niveles de confort para el usuario, proporcionan un tacto excelente, ligereza y flexibilidad, sensación de frescura por su gran transpirabilidad, buen agarre en ambientes secos, ligeramente húmedos o aceitados, excelente resistencia a la abrasión, mayor durabilidad.

Talla/Color	Jaspeado/negro.		€/ u.
	Ref.	Código	
6	21060130	4213/6	7,33
7	21060131	4213/7	
8	21060132	4213/8	
9	21060133	4213/9	
10	21060134	4213/10	
11	21060135	4213/11	



Guante resistente al corte con la nueva tecnología K-rock® mezclado con nylon con doble recubrimiento de nitrilo acabado arenoso.



Soporte sin costuras con tecnología textil K-ROCK® y galga 18 que aporta tacto, flexibilidad y confort. Refuerzo entre el pulgar y el índice que aporta mayor resistencia al desgaste y la rotura. Recubierto en palma y medio dorso con una primera capa de nitrilo estanco y la segunda capa de nitrilo arenoso y PU de base acuosa que proporciona un excelente agarre en entornos secos, húmedos o aceitados. El nitrilo ofrece un mayor agarre en aceite que cualquier otro recubrimiento. Resistente al calor por contacto, 100°C durante 15". Excelente resistencia a la abrasión, mayor durabilidad. Apto para dispositivos táctiles.



Talla/Color	Jaspeado/negro/naranja.		€/ u.
	Ref.	Código	
6	21060136	4220RF/6	9,33
7	21060137	4220RF/7	
8	21060138	4220RF/8	
9	21060139	4220RF/9	
10	21060140	4220RF/10	
11	21060141	4220RF/11	

Talla/Color	Rojo/negro.		€/ u.
	Ref.	Código	
6	21060142	4230RF/6	12,74
7	21060143	4230RF/7	
8	21060144	4230RF/8	
9	21060145	4230RF/9	
10	21060146	4230RF/10	
11	21060147	4230RF/11	

Guante resistente al corte con la nueva tecnología K-rock® con fibra de vidrio e hilo de acero recubierto de nitrilo arenoso.



Refuerzo entre el pulgar y el índice que aporta mayor resistencia al desgaste y la rotura. Buen agarre en ambientes secos, húmedos y aceitados. Excelente resistencia a la abrasión. Mayor durabilidad. Apto para uso de dispositivos táctiles.

Talla/Color	Azul/negro.		€/ u.
	Ref.	Código	
6	21060148	4211RF/6	7,42
7	21060149	4211RF/7	
8	21060150	4211RF/8	
9	21060151	4211RF/9	
10	21060152	4211RF/10	
11	21060153	4211RF/11	



Guante resistente al corte con la nueva tecnología K-rock® con recubrimiento de nitrilo en palma. Refuerzo especial anti-impacto de goma eva en nudillos y palma.



Refuerzo entre el pulgar e índice para un menor desgaste. Protectores de goma termoplástica (TPR) en dorso y dedos muy flexibles, que aumentan la protección dorsal de la zona dorsal. Gran resistencia a la abrasión, mayor durabilidad. Buen agarre en ambientes secos, ligeramente húmedos o aceitados.

Talla/Color	Jaspeado/negro.		€/ u.
	Ref.	Código	
8	21060154	4560IM/8	16,74
9	21060155	4560IM/9	
10	21060156	4560IM/10	
11	21060157	4560IM/11	



Guante con fibra resistente al corte K-rock®, recubierto de nitrilo T-touch en palma y medio dorso y piel de serraje hidrofugada en palma



El nitrilo T-Touch en palma y medio dorso proporciona una mayor impermeabilidad a aceites y grasas en esa zona, para trabajos con mayor exposición a estos productos. Resistente al calor por contacto

Talla/Color	Gris/negro.		€ / u.
	Ref.	Código	
7	2402069	4434/7	25,35
8	2402070	4434/8	
9	2402071	4434/9	
10	2402072	4434/10	
11	2402073	4434/11	
12	2402074	4434/12	



Fibra Dyneema® Bio-Based sin costuras con recubrimiento de poliuretano en palma



La tecnología Dyneema® Diamond no utiliza fibra de vidrio para incrementar los niveles de corte y evita que el usuario pueda tener alergias o irritaciones en la piel. Tacto excelente, ligereza y flexibilidad. Sensación de frescura, gran transpirabilidad

Talla/Color	Gris.		€ / u.
	Ref.	Código	
6	2402075	DY003RF/6	8,03
7	2402076	DY003RF/7	
8	2402077	DY003RF/8	
9	2402078	DY003RF/9	
10	2402079	DY003RF/10	
11	2402080	DY003RF/11	



Guante con alta resistencia al corte que incorpora la fibra K-ROCK®, con recubrimiento de nitrilo foam



Buen agarre en ambientes secos, húmedos y aceitados; ya que el nitrilo proporciona mayor resistencia al aceite y solventes que cualquier otro recubrimiento. Gran resistencia a la abrasión, mayor durabilidad

Talla/Color	Gris/negro.		€ / u.
	Ref.	Código	
6	2402081	KR012RF/6	9,35
7	2402082	KR012RF/7	
8	2402083	KR012RF/8	
9	2402084	KR012RF/9	
10	2402085	KR012RF/10	



Guante con alta resistencia al corte que incorpora la fibra textil K-Rock®, recubierto de eco látex con ventosas en la palma



Soporte sin costuras con tecnología textil K-ROCK®, que aporta tacto, ligereza, flexibilidad y confort. Excelente agarre en situaciones secas y húmedas gracias a su diseño en palma de microventosas. Recubrimiento de látex ecológico ya que no se utilizan aditivos ni productos químicos en su proceso de fabricación

Talla/Color	Jaspeado/negro.		€ / u.
	Ref.	Código	
7	2402086	H4580/7	5,75
8	2402087	H4580/8	
9	2402088	H4580/9	
10	2402089	H4580/10	
11	2402090	H4580/11	



Guante con alta resistencia al corte que incorpora la fibra textil K-ROCK®, recubierto de poliuretano en la palma



Refuerzo de nitrilo entre el pulgar y el índice que aporta mayor resistencia al desgaste y la rotura. Tacto extra con un óptimo agarre en superficies secas y ligeramente húmedas. Sensación de frescura por su gran transpirabilidad



Talla/Color	Gris.		€/ u.
	Ref.	Código	
6	2402091	H4540RF/6	9,18
7	2402092	H4540RF/7	
8	2402093	H4540RF/8	
9	2402094	H4540RF/9	
10	2402095	H4540RF/10	
11	2402096	H4540RF/11	

Guante de fibra K-rock® sin costuras mezclado con otras fibras sintéticas recubierto de nitrilo micro foam con interior de vulvizo



Soporte sin costuras con tecnología textil K-ROCK®, la nueva tecnología con protección al corte de Juba, que aporta tacto, ligereza, flexibilidad y confort. Forro interior de vulvizo que mantiene la temperatura de las manos estables en situaciones de frío



Talla/Color	Gris/negro.		€/ u.
	Ref.	Código	
8	2402097	4590WT/8	7,33
9	2402098	4590WT/9	
10	2402099	4590WT/10	
11	2402100	4590WT/11	

Guante con alta resistencia al corte que incorpora la fibra K-ROCK®, con recubrimiento de nitrilo en palma y refuerzo especial de goma eva en dorso y nudillos. Especial anti-impacto



Refuerzo entre pulgar e índice para un menor desgaste. Protectores de goma termoplástica (TPR) en dorso y dedos muy flexibles, que aumentan la protección de la zona dorsal. Refuerzo especial de goma eva en palma para mejor protección



Talla/Color	Jaspeado/negro.		€/ u.
	Ref.	Código	
8	2402101	H4560IM/8	17,26
9	2402102	H4560IM/9	
10	2402103	H4560IM/10	
11	2402104	H4560IM/11	

Fibra textil K-rock® recubierto de nitrilo foam en palma



Gran resistencia a la abrasión, mayor durabilidad. Buena resistencia al corte, nivel D. Refuerzo entre el pulgar y el índice que aporta mayor resistencia al desgaste y la rotura. roporciona buen agarre en entornos aceitosos y húmedos



Talla/Color	Jaspeado/negro.		€/ u.
	Ref.	Código	
6	2402105	4212RF/6	6,50
7	2402106	4212RF/7	
8	2402107	4212RF/8	
9	2402108	4212RF/9	
10	2402109	4212RF/10	
11	2402110	4212RF/11	



Guante de malla metálica, reversible. Antes GCM*0

Cota de malla, guante de 5 dedos reversible. Cierre con botón a presión. Identificación de la talla por el color de la tira. Gracias a la tira higiénica flexible y ajustable, este guante puede adaptarse al usuario. La malla metálica y la tira de poliuretano permiten un lavado eficaz. Cumple la norma EN 1082-1:1997: Guantes y protectores de los brazos contra los cortes y pinchazos producidos por cuchillos de mano.

Talla/Color	Gris.		€ / u.
	Ref.	Código	
XXS	1001660	OGCM.131.00.000.GA	89,98
XS	1001661	OGCM.131.10.000.GA	
S	1001662	OGCM.131.20.000.GA	
M	1001663	OGCM.131.30.000.GA	
L	1001664	OGCM.131.40.000.GA	
XL	1001665	OGCM.131.50.000.GA	



Guante de malla metálica Wilco ambidextro con cierre elástico de malla



Cumple con las normas NF EN 1082-1, NF EN 14328, NF EN 1811 +A1 e ISO 13999-1. Guante de malla metálica 100% inoxidable. Ambidiestro. Ajuste en muñeca y antebrazo con resorte ultraplano. Identificación de la talla con un botón de color. Fácil de poner y quitar. Cada guante tiene una placa de trazabilidad con un número que permite rastrear el historial del guante.

Talla/Color	Gris.		€ / u.
	Ref.	Código	
XXS	1001671	OGWO131.00.000.GA	87,40
XS	1001672	OGWO131.10.000.GA	
S	1001673	OGWO131.20.000.GA	
M	1001674	OGWO131.30.000.GA	
L	1001675	OGWO131.40.000.GA	



Guante soldador



Piel de calidad extra. Resistente al calor por contacto (100°C durante 15 segundos). Excelente comportamiento a la llama y a las pequeñas salpicaduras. Muy confortable gracias a su forro interior de algodón en palma y dorso. Cosido con hilo de Kevlar® para mayor durabilidad. Costuras protegidas. Cumple con la norma EN12477:2001+A1:2005 de guantes de protección para soldadores de tipo A.

Talla/Color	Rojo.		€ / u.
	Ref.	Código	
	1001578	408	13,21
10	1001579	408K/10	10,92
9	8001632	GP-044	7,91



Guante riesgo térmico



Muy suave y cómodo gracias a su forro de algodón interior. Resistente al calor por contacto (250°C durante 15 segundos), excelente comportamiento a la llama y al calor convectivo. Mayor durabilidad por el algodón vulvrizo.

Talla/Color	Beige.		€ / u.
	Ref.	Código	
Única	1004900	5200	25,88
Única	1004901	5700	22,14
Única	1004902	214IGPN	34,24



Guante neopreno verde y negro, especial 100-250°C



Sólido agarre en entornos secos y húmedos. Buen comportamiento en ambientes fríos. Totalmente recubierto para una mayor protección. La función higienizante Sanitized® protege los guantes de la formación de hongos, ácaros y bacterias, evita los olores, proporciona una protección duradera a los polímeros y minimiza la irritación de la piel.



Talla/Color	Verde/negro.		€ / u.
	Ref.	Código	
8	1001610	5630/8	10,91
9	1001611	5630/9	
10	1001612	5630/10	

Guante cuero flor vacuno forrado con Thinsulate



Forro interior Thinsulate que ofrece un gran confort y protección al frío (0°C). Flexible y confortable. Sin tratamiento hidrofugado.



Beige.		€ / u.
Ref.	Código	
1001613	H412FT	20,25

Guante poliamida/algodón con recubrimiento de látex rugoso negro, forro invierno



Muy ergonómico y flexible. Buen agarre en superficies secas o mojadas. Guante confortable gracias a la combinación de la poliamida y el algodón. Interior con acabado de vultrizo que confiere mayor protección contra el frío (0°C). Buena protección para riesgos mecánicos y protección al corte moderado. La función higienizante Sanitized® protege los guantes de la formación de hongos, ácaros y bacterias, evita los olores, proporciona una protección duradera a los polímeros y minimiza la irritación de la piel.



Talla/Color	Negro/blanco.		€ / u.
	Ref.	Código	
M	1001614	252/M	6,70
L	1001615	252/L	
XL	1001616	252/XL	

Guante térmico



Poliéster con elastómero: máximo confort. Recubrimiento látex aumenta durabilidad y agarre. Interior acrílico rizado aumenta las propiedades térmicas. Impermeable 100%: ofrece gran protección frente a líquidos. Desteridad 5 (mínimo 0, máximo 5)



Ref.	Código	Talla	€ / u.
2402117	760 COLDGRIP-7	7	7,60
2402118	760 COLDGRIP-8	8	7,60
2402119	760 COLDGRIP-9	9	7,60
2402120	770 COLDGRIP-10	10	7,60
2402121	760 COLDGRIP-11	11	7,60

Guante Poliéster con forro interior recubierto de látex arenoso en palma y el dedo pulgar. Resistente al calor por contacto 250° y en ambientes fríos hasta -10°C. Galga 10.



Interior de vulvizo que ayuda a mantener las manos estables en ambientes de frío hasta -10° C. Excelente agarre en situaciones húmedas y secas. Dedo pulgar recubierto para una protección adicional (zona de mayor desgaste). Resistente al calor por contacto (250° C durante 15 segundos).



Talla/Color	Naranja.		€ / u.
	Ref.	Código	
7	21060162	H5300TH/7	6,19
8	21060163	H5300TH/8	
9	21060164	H5300TH/9	
10	21060165	H5300TH/10	

Guante de nylon sin costuras con forro interior Terry. Recubrimiento nitrilo FOAM



Soporte térmico sin costuras. Totalmente cubierto de nitrilo foam. Diseño anatómico. Menos 20° Gran dexteridad. Excelente resistencia a la abrasión. Menos 20°C



GF-020/8



GF-010/8

Talla/Color	Azul.		Negro/amarillo.		€ / u.
	Ref.	Código	Ref.	Código	
8	8001635	GF-020/8	8001640	GF-010/8	8,53
9	8001636	GF-020/9	8001641	GF-010/9	
10	8001637	GF-020/10	8001642	GF-010/10	6,92
11			8001643	GF-010/11	

Poliéster/algodón reciclado recubierto de látex rugoso, forrado interior



Soporte de poliéster/algodón de 62% fibras recicladas (el 55% de poliéster reciclado y 7% de algodón reciclado). Su proceso de fabricación implica una reducción de consumo de agua y energía, así como de huella de carbono y residuos de plástico. Resistente al calor por contacto (resiste 250°C durante 15") y frío



Talla/Color	Verde.		€ / u.
	Ref.	Código	
7	2402122	H251NTWT/7	5,75
8	2402123	H251NTWT/8	
9	2402124	H251NTWT/9	
10	2402125	H251NTWT/10	
11	2402126	H251NTWT/11	

Guante de poliéster con doble recubrimiento de látex en la palma y dedo pulgar con forro interior



Totalmente recubierto para mayor estanqueidad, la primera capa de látex estanco y la segunda capa de látex arenoso que aporta un excelente agarre en entornos húmedos y secos. Buena resistencia a la abrasión y a la perforación, mayor durabilidad



Talla/Color	Azul.		€ / u.
	Ref.	Código	
7	2402127	259WT/7	5,37
8	2402128	259WT/8	
9	2402129	259WT/9	
10	2402130	259WT/10	
11	2402131	259WT/11	

Guantelete de poliéster/algodón y fieltro no tejido de poliéster recubierto de nitrilo



Manipulaciones intermitentes de productos calientes hasta 250°C. Manipulación de piezas calientes con riesgo de corte moderado. Industria del vidrio plano



Talla/Color	Gris.		€/ u.
	Ref.	Código	
9	2402137	5235CC/9	13,64
10	2402138	5235CC/10	

Guante sin costuras de Nylon® con interior vulvizo recubierto en palma de PVC con tratamiento HPT. Especial para bajas temperaturas



Interior con acabado vulvizo que mantiene la temperatura estable de las manos en situaciones con temperaturas bajas. Recubierto de PVC con tecnología HPT (Hydropellent Technology) que repele los líquidos y facilita el agarre en medios húmedos y secos



Talla/Color	Negro/azul.		€/ u.
	Ref.	Código	
7	2402139	H5130W/7	8,61
8	2402140	H5130W/8	
9	2402141	H5130W/9	
10	2402142	H5130W/10	
11	2402143	H5130W/11	8,61

Guantelete totalmente recubierto con nitrilo Microfinish® y doble forro interior



Confort y amplio aislamiento térmico en aplicaciones que precisan protección al calor y al frío gracias a su soporte de poliéster y forro acrílico. La tecnología Microfinish® ofrece impermeabilidad total, ya que sus microventosas dispersan líquidos y aceites



Talla/Color	Verde.		€/ u.
	Ref.	Código	
8	2402144	566TH/8	15,46
9	2402145	566TH/9	
10	2402146	566TH/10	

Silverstone



- Puntera plástica anti-impactos 200J. - Planta textil antiperforación 1100N. - Suela contac PU+TPU, antideslizamiento extremo, SRC y shock absorber. - Plantilla TRI TEC viscoelástica antiestática y antibacterias. - Piel natural 1ª flor hidrófuga. - Forro muy absorbente y resistente a la abrasión. - Protección de tobillos almohadado. - Panter Technology Optimal Sole. Calzado con mayor amortiguación y retorno de energía. Transforma la energía cinética de cada paso en impulso para el siguiente. Beneficios para el usuario: reparto óptimo de las presiones plantares, menor fatiga muscular, reducción dolor lumbar, menor riesgo de lesiones. - Certificado OEKO TEX, Standard 100. Los textiles utilizados están exentos de productos nocivos para las personas y/o medio ambiente.

Talla/Color	Negro.		Categoría	€/ u.
	Ref.	Código		
37	1008121	457511700	S3	91,35
38	1008122	457511700		
39	1008123	457511700		
40	1008124	457511700		
41	1008125	457511700		
42	1008126	457511700		
43	1008127	457511700		
44	1008128	457511700		
45	1008129	457511700		
46	1008130	457511700		
47	1008131	457511700		
48	1008132	457511700		



Cauro oxigeno



- Puntera plástica anti-impactos 200J. - Planta textil antiperforación 1100N. - Suela PU+TPU Oxigeno. - Plantilla interior transpirable, termoconformada, con tejido termorregulador Coolmax antiestático y antibacteriana. - Piel serraje hidrófugo + Tejido Mesh ultra transpirable. - Forro muy absorbente y resistente a la abrasión. - Panter Technology Oxigeno. Calzado impermeable y transpirable a través de la suela. Regula la temperatura interior, mantiene el pie seco, potencia el confort. - Panter Technology Optimal Sole. Calzado con mayor amortiguación y retorno de energía. Transforma la energía cinética de cada paso en impulso para el siguiente. Beneficios para el usuario: reparto óptimo de las presiones plantares, menor fatiga muscular, reducción dolor lumbar, menor riesgo de lesiones. - Certificado OEKO TEX, Standard 100. Los textiles utilizados están exentos de productos nocivos para las personas y/o medio ambiente. - Panter Metal Free.

Talla/Color	Gris.		Categoría	€/ u.
	Ref.	Código		
36	1021001	439961500	S1P	65,47
37	1021002	439961500		
38	1021003	439961500		
39	1021004	439961500		
40	1021005	439961500		
41	1021006	439961500		
42	1021007	439961500		
43	1021008	439961500		
44	1021009	439961500		
45	1021010	439961500		
46	1021011	439961500		
47	1021012	439961500		
48	1021013	439961500		



Diamante plus PU/TPU



- Puntera plástica anti-impactos 200J. - Suela PU+TPU, coeficiente de antideslizamiento máximo, SRC. - Plantilla AIR PLUS antiestática y antibacteriana. - Piel natural 1ª flor hidrófuga. - Bandas reflectantes 3M con retro reflexión certificada. - Horma extra ancha. - Forro muy absorbente y resistente a la abrasión. - Diseño antitorceduras. - Panter Technology Optimal Sole. Calzado con mayor amortiguación y retorno de energía. Transforma la energía cinética de cada paso en impulso para el siguiente. Beneficios para el usuario: reparto óptimo de las presiones plantares, menor fatiga muscular, reducción dolor lumbar, menor riesgo de lesiones. - Certificado OEKO TEX, Standard 100. Los textiles utilizados están exentos de productos nocivos para las personas y/o medio ambiente. - Panter Metal Free.

Talla/Color	Negro.		Categoría	€/ u.	Talla/Color	Negro.		Categoría	€/ u.
	Ref.	Código				Ref.	Código		
36	1005901	414041700	S2	50,18	36	1006001	434041700	S3	55,35
37	1005902	414041700			37	1006002	434041700		
38	1005903	414041700			38	1006003	434041700		
39	1005904	414041700			39	1006004	434041700		
40	1005905	414041700			40	1006005	434041700		
41	1005906	414041700			41	1006006	434041700		
42	1005907	414041700			42	1006007	434041700		
43	1005908	414041700			43	1006008	434041700		
44	1005909	414041700			44	1006009	434041700		
45	1005910	414041700			45	1006010	434041700		
46	1005911	414041700			46	1006011	434041700		
47	1005912	414041700			47	1006012	434041700		
48	1005913	414041700	48	1006013	434041700				



07



Silex plus PU/TPU



- Puntera plástica anti-impactos 200J. - Suela PU+TPU, coeficiente de antideslizamiento máximo, SRC - Plantilla AIR PLUS antiestática y antibacteriana. - Piel natural 1ª flor hidrófuga. - Bandas reflectantes 3M con retro reflexión certificada. - Horma extra ancha. - Forro muy absorbente y resistente a la abrasión. - Protección de tobillos almohadado de alta densidad. Diseño antitorceduras. - Panter Technology Optimal Sole. Calzado con mayor amortiguación y retorno de energía. Transforma la energía cinética de cada paso en impulso para el siguiente. Beneficios para el usuario: reparto óptimo de las presiones plantares, menor fatiga muscular, reducción dolor lumbar, menor riesgo de lesiones. - Certificado OEKO TEX, Standard 100. Los textiles utilizados están exentos de productos nocivos para las personas y/o medio ambiente. - Panter Metal Free.

Talla/Color	Negro.		Categoría	€ / u.	Talla/Color	Negro.		Categoría	€ / u.
	Ref.	Código				Ref.	Código		
36	1006735	414031700	S2	53,48	36	1006750	434031700	S3	58,65
37	1006736	414031700			37	1006751	434031700		
38	1006737	414031700			38	1006752	434031700		
39	1006738	414031700			39	1006753	434031700		
40	1006739	414031700			40	1006754	434031700		
41	1006740	414031700			41	1006755	434031700		
42	1006741	414031700			42	1006756	434031700		
43	1006742	414031700			43	1006757	434031700		
44	1006743	414031700			44	1006758	434031700		
45	1006744	414031700			45	1006759	434031700		
46	1006745	414031700			46	1006760	434031700		
47	1006746	414031700			47	1006761	434031700		
48	1006747	414031700	48	1006762	434031700				



Fragua plus PU/TPU



- Bota para soldadores. - Puntera plástica anti-impactos 200J. - Suela PU+TPU, coeficiente de antideslizamiento máximo, SRC - Plantilla AIR PLUS antiestática y antibacteriana. - Piel natural 1ª flor hidrófuga. - Hebilla desprendimiento rápido. - Bandas reflectantes 3M con retro reflexión certificada. - Horma extra ancha. - Forro muy absorbente y resistente a la abrasión. - Protección de tobillos almohadado de alta densidad. Diseño antitorceduras. - Panter Technology Optimal Sole. Calzado con mayor amortiguación y retorno de energía. Transforma la energía cinética de cada paso en impulso para el siguiente. Beneficios para el usuario: reparto óptimo de las presiones plantares, menor fatiga muscular, reducción dolor lumbar, menor riesgo de lesiones. - Certificado OEKO TEX, Standard 100. Los textiles utilizados están exentos de productos nocivos para las personas y/o medio ambiente.

Talla/Color	Negro.		Categoría	€ / u.	Talla/Color	Negro.		Categoría	€ / u.
	Ref.	Código				Ref.	Código		
36	1007711	414021700	S2	75,30	36	1007811	434021700	S3	61,50
37	1007712	414021700			37	1007812	434021700		
38	1007700	414021700			38	1007800	434021700		
39	1007701	414021700			39	1007801	434021700		
40	1007702	414021700			40	1007802	434021700		
41	1007703	414021700			41	1007803	434021700		
42	1007704	414021700			42	1007804	434021700		
43	1007705	414021700			43	1007805	434021700		
44	1007706	414021700			44	1007806	434021700		
45	1007707	414021700			45	1007807	434021700		
46	1007708	414021700			46	1007808	434021700		
47	1007709	414021700			47	1007809	434021700		
48	1007710	414021700	48	1007810	434021700				



Dragon plus S3 negro PU/TPU



- Puntera plástica anti-impactos 200J. - Planta textil antiperforación 1100N. - Suela PU+TPU, coeficiente de antideslizamiento máximo, SRC - Plantilla AIR PLUS antiestática y antibacteriana. - Piel natural 1ª flor hidrófuga. - Ganchos antioxidantes. - Bandas reflectantes 3M con retro reflexión certificada. - Horma extra ancha. - Forro muy absorbente y resistente a la abrasión. - Protección de tobillos almohadado de alta densidad. Diseño antitorceduras. - Panter Technology Optimal Sole. Calzado con mayor amortiguación y retorno de energía. Transforma la energía cinética de cada paso en impulso para el siguiente. Beneficios para el usuario: reparto óptimo de las presiones plantares, menor fatiga muscular, reducción dolor lumbar, menor riesgo de lesiones. - Certificado OEKO TEX, Standard 100. Los textiles utilizados están exentos de productos nocivos para las personas y/o medio ambiente.

Talla/Color	Negro.		Categoría	€ / u.
	Ref.	Código		
37	1007312	434011700	S3	65,10
38	1007300	434011700		
39	1007301	434011700		
40	1007302	434011700		
41	1007303	434011700		
42	1007304	434011700		
43	1007305	434011700		
44	1007306	434011700		
45	1007307	434011700		
46	1007308	434011700		
47	1007309	434011700		
48	1007310	434011700		



Silex link S2



- Puntera plástica anti-impactos 200J. - Suela PU+PU Ergonomic. - Plantilla antiestática y antibacteriana. - Piel natural 1ª flor hidrófuga muy transpirable. - Forro muy absorbente y resistente a la abrasión. - Cierre con cordones y lengüeta con fuelle. - Panther Technology Ergonomic. 1er Estudio Funcional de calzado profesional en confort y ergonomía. Aumento de confort y reducción de la fatiga y riesgo de lesiones. - Panther Technology Optimal Sole. Calzado con mayor amortiguación y retorno de energía. Transforma la energía cinética de cada paso en impulso para el siguiente. - Certificado OEKO TEX, Standard 100. Los textiles utilizados están exentos de productos nocivos para las personas y/o medio ambiente. - Panther Metal Free.

Talla/Color	Negro.		Categoría	€ / u.
	Ref.	Código		
35	1021412	456031700	S2	48,98
36	1021413	456031700		
37	1021414	456031700		
38	1021415	456031700		
39	1021416	456031700		
40	1021417	456031700		
41	1021418	456031700		
42	1021419	456031700		
43	1021420	456031700		
44	1021421	456031700		
45	1021422	456031700		
46	1021423	456031700		
47	1021424	456031700		
48	1021425	456031700		



Diamante link S2



- Puntera plástica anti-impactos 200J. - Suela PU+PU Ergonomic. - Plantilla antiestática y antibacteriana. - Piel natural 1ª flor hidrófuga, muy transpirable. - Forro muy absorbente y resistente a la abrasión. - Cierre con cordones y lengüeta con fuelle. - Panther Technology Ergonomic. 1er Estudio Funcional de calzado profesional en confort y ergonomía. Aumento de confort y reducción de la fatiga y riesgo de lesiones. - Panther Technology Optimal Sole. Calzado con mayor amortiguación y retorno de energía. Transforma la energía cinética de cada paso en impulso para el siguiente. - Certificado OEKO TEX, Standard 100. Los textiles utilizados están exentos de productos nocivos para las personas y/o medio ambiente. - Panther Metal Free.

Talla/Color	Negro.		Categoría	€ / u.
	Ref.	Código		
35	1021462	456041700	S2	44,85
36	1021463	456041700		
37	1021464	456041700		
38	1021465	456041700		
39	1021466	456041700		
40	1021467	456041700		
41	1021468	456041700		
42	1021469	456041700		
43	1021470	456041700		
44	1021471	456041700		
45	1021472	456041700		
46	1021473	456041700		
47	1021474	456041700		
48	1021475	456041700		



Fragua link s2



- Puntera acero anti-impactos 200J. - Suela PU/PU. - Plantilla antiestática y antibacteriana. - Piel serraje natural hidrofugado y cordura. - Forro muy absorbente y resistente a la abrasión. - Ganchos antioxidantes. - Puntera reforzada. - Cierre mediante cordones y fuelle interior. - Panther Technology Optimal Sole. Calzado con mayor amortiguación y retorno de energía. Transforma la energía cinética de cada paso en impulso para el siguiente. Beneficios para el usuario: reparto óptimo de las presiones plantares, menor fatiga muscular, reducción dolor lumbar, menor riesgo de lesiones. - Certificado OEKO TEX, Standard 100. Los textiles utilizados están exentos de productos nocivos para las personas y/o medio ambiente.

Talla/Color	Negro.		Categoría	€ / u.
	Ref.	Código		
34	1021511	456021700	S2	51,00
35	1021512	456021700		
36	1021513	456021700		
38	1021515	456021700		
39	1021516	456021700		
40	1021517	456021700		
41	1021518	456021700		
42	1021519	456021700		
43	1021520	456021700		
44	1021521	456021700		
45	1021522	456021700		
46	1021523	456021700		
47	1021524	456021700		
48	1021525	456021700		



E zion super brega



- Puntera acero anti-impactos 200J. - Planta acero antiperforación 1100N. - Suela PU/PU. - Plantilla antiestática y antibacteriana. - Piel serraje natural hidrofugado y cordura. - Forro muy absorbente y resistente a la abrasión. - Ganchos antioxidantes. - Puntera reforzada. - Cierre mediante cordones y fuelle interior. - Panter Technology Optimal Sole. Calzado con mayor amortiguación y retorno de energía. Transforma la energía cinética de cada paso en impulso para el siguiente. Beneficios para el usuario: reparto óptimo de las presiones plantares, menor fatiga muscular, reducción dolor lumbar, menor riesgo de lesiones. - Certificado OEKO TEX, Standard 100. Los textiles utilizados están exentos de productos nocivos para las personas y/o medio ambiente.

Talla/Color	Gris.		Categoría	€/ u.
	Ref.	Código		
38	1006851	734111500	S1P	34,80
39	1006852	734111500		
40	1006853	734111500		
41	1006854	734111500		
42	1006855	734111500		
43	1006856	734111500		
44	1006857	734111500		
45	1006858	734111500		
46	1006859	734111500		
47	1006860	734111500		
48	1006861	734111500		



E zion super ferro



- Puntera acero anti-impactos 200J. - Planta antiperforación acero 1100N. - Suela PU/PU. - Plantilla antiestática y antibacteriana. - Piel natural hidrófuga. - Forro muy absorbente y resistente a la abrasión. - Puntera reforzada. - Cierre mediante cordones y fuelle interior. - Panter Technology Optimal Sole. Calzado con mayor amortiguación y retorno de energía. Transforma la energía cinética de cada paso en impulso para el siguiente. Beneficios para el usuario: reparto óptimo de las presiones plantares, menor fatiga muscular, reducción dolor lumbar, menor riesgo de lesiones. - Certificado OEKO TEX, Standard 100. Los textiles utilizados están exentos de productos nocivos para las personas y/o medio ambiente.

Talla/Color	Negro.		Categoría	€/ u.
	Ref.	Código		
38	1006936	734041700	S3	34,05
39	1006937	734041700		
40	1006938	734041700		
41	1006939	734041700		
42	1006940	734041700		
43	1006941	734041700		
44	1006942	734041700		
45	1006943	734041700		
46	1006944	734041700		
47	1006945	734041700		
48	1006946	734041700		



E Zion Super Forja



- Bota para soldadores. - Puntera acero anti-impactos 200J. - Suela PU/PU. - Plantilla antiestática y antibacteriana. - Piel natural hidrófuga. - Forro muy absorbente y resistente a la abrasión. - Collarín ergonómico más comodidad. - Puntera reforzada. - Cierre mediante hebilla y solapa de piel. - Panter Technology Optimal Sole. Calzado con mayor amortiguación y retorno de energía. Transforma la energía cinética de cada paso en impulso para el siguiente. Beneficios para el usuario: reparto óptimo de las presiones plantares, menor fatiga muscular, reducción dolor lumbar, menor riesgo de lesiones. - Certificado OEKO TEX, Standard 100. Los textiles utilizados están exentos de productos nocivos para las personas y/o medio ambiente.

Talla/Color	Negro.		Categoría	€/ u.
	Ref.	Código		
39	1022203	734021700	S3	34,42
40	1022204	734021700		
41	1022205	734021700		
42	1022206	734021700		
43	1022207	734021700		
44	1022208	734021700		
45	1022209	734021700		
46	1022210	734021700		
47	1022211	734021700		
48	1022212	734021700		
36	8000266	734021700		



E Zion Super Numan MF



- Puntera plástica anti-impactos 200J. - Planta textil antiperforación 1100N. - Suela PU/PU. - Plantilla antiestática y antibacteriana. - Piel serraje natural hidrofugado. Perforado, especial ambientes calurosos. - Forro muy absorbente y resistente a la abrasión. - Panter Technology Optimal Sole. Calzado con mayor amortiguación y retorno de energía. Transforma la energía cinética de cada paso en impulso para el siguiente. Beneficios para el usuario: reparto óptimo de las presiones plantares, menor fatiga muscular, reducción dolor lumbar, menor riesgo de lesiones. - Certificado OEKO TEX, Standard 100. Los textiles utilizados están exentos de productos nocivos para las personas y/o medio ambiente. - Panter Metal Free.

Talla/Color	Gris.		Categoría	€ / u.
	Ref.	Código		
37	1022251	793121500	S1P	38,63
38	1022252	793121500		
39	1022253	793121500		
40	1022254	793121500		
41	1022255	793121500		
42	1022256	793121500		
43	1022257	793121500		
44	1022258	793121500		
45	1022259	793121500		
46	1022260	793121500		
47	1022261	793121500		
48	1022262	793121500		



Voltio SBP marrón



- Bota de seguridad desarrollada para proteger contra riesgo eléctrico. - Sometida a las pruebas de ensayo de la Normativa 50321 con resultado óptimo. - Puntera plástica anti-impactos 200J. - Planta textil antiperforación 1100N. - Suela PU+TPU multifunción. - Plantilla aislante electricidad. - Diseño especial que absorbe impactos frontales. - El diseño del puente del pie permite un óptimo agarre y descanso del pie sobre superficies irregulares o escaleras, torres de alta tensión, etc. - Piel natural 1ª flor hidrófuga + Sympatex. - Panter Technology Optimal Sole. Calzado con mayor amortiguación y retorno de energía. Transforma la energía cinética de cada paso en impulso para el siguiente. Beneficios para el usuario: reparto óptimo de las presiones plantares, menor fatiga muscular, reducción dolor lumbar, menor riesgo de lesiones. - Panter Technology HIGH2OUT by Sympatex. Membrana impermeable, 120% más transpirable. 250% más absorbente, 100% resistente al viento, 100% reciclable y ecológica. - Certificado OEKO TEX, Standard 100. Los textiles utilizados están exentos de productos nocivos para las personas y/o medio ambiente. - Panter Metal Free.

Talla/Color	Marrón.		Categoría	€ / u.
	Ref.	Código		
37	1006966	939312700	SBP	104,99
38	1006967	939312700		
39	1006968	939312700		
40	1006969	939312700		
41	1006970	939312700		
42	1006971	939312700		
43	1006972	939312700		
44	1006973	939312700		
45	1006974	939312700		
46	1006975	939312700		
47	1006976	939312700		
48	1006977	939312700		



Alpina Oxígeno



- Puntera plástica anti-impactos 200J. - Planta textil antiperforación 1100N. - Suela PU+TPU Oxígeno. - Plantilla interior transpirable, termoconformada, con tejido termorregulador Coolmax antiestático y antibacteriana. - Piel nobuk 1ª flor hidrófuga + Sympatex - Ganchos no metálicos. - Sistema de rápido atado y zona de recogerdones. - Panter Technology Oxígeno. Calzado impermeable y transpirable a través de la suela. Regula la temperatura interior, mantiene el pie seco, potencia el confort. - Panter Technology Optimal Sole. Calzado con mayor amortiguación y retorno de energía. Transforma la energía cinética de cada paso en impulso para el siguiente. Beneficios para el usuario: reparto óptimo de las presiones plantares, menor fatiga muscular, reducción dolor lumbar, menor riesgo de lesiones. - Panter Technology HIGH2OUT by Sympatex. Membrana impermeable, 120% más transpirable. 250% más absorbente, 100% resistente al viento, 100% reciclable y ecológica. - Certificado OEKO TEX, Standard 100. Los textiles utilizados están exentos de productos nocivos para las personas y/o medio ambiente. - Panter Metal Free.

Talla/Color	Verde.		Categoría	€ / u.
	Ref.	Código		
36	8000698	439941300	S3	119,93
37	8000699	439941300		
38	8000700	439941300		
39	8000701	439941300		
40	8000702	439941300		
41	8000703	439941300		
42	8000704	439941300		
43	8000705	439941300		
44	8000706	439941300		
45	8000707	439941300		
46	8000708	439941300		
47	8000709	439941300		
48	8000710	439941300		



07

Argos



- Puntera plástica anti-impactos 200J. - Planta textil antiperforación 1100N. - Suela Caucho doble densidad + PU. - Textil tecnológico de alta resistencia, rejilla doble frontura y acanalado hexagonal, combinado con PU flexible de última generación que refuerza el corte y se ajusta a la ergonomía del pie protegiendo el calzado. - Plantilla TRI TEC viscoelástica antiestática y antibacteriana. - Deportivo de seguridad ultra transpirable. - Máxima flexibilidad. - Cierre mediante cordones y lengüeta almohadillada. - Certificado OEKO TEX, Standard 100. Los textiles utilizados están exentos de productos nocivos para las personas y/o medio ambiente. - Panter Technology TRI TEC. Tecnología viscoelástica que aporta máximo confort. Ralentiza la energía cinética del movimiento del pie para impulsar el siguiente paso. Alta resistencia a la abrasión, mantiene el pie seco y evita malos olores, sistema shock absorber en la zona de mayor impacto. - Panter Metal Free.

Talla/Color	Negro.		Categoría	€/ u.
	Ref.	Código		
36	8000711	830211700	SIP	82,43
37	8000712	830211700		
38	8000713	830211700		
39	8000714	830211700		
40	8000715	830211700		
41	8000716	830211700		
42	8000717	830211700		
43	8000718	830211700		
44	8000719	830211700		
45	8000720	830211700		
46	8000721	830211700		
47	8000722	830211700		
48	8000723	830211700		

Talla/Color	Azul.		Categoría	€/ u.
	Ref.	Código		
36	8000737	830212100	SIP	82,43
37	8000738	830212100		
38	8000739	830212100		
39	8000740	830212100		
40	8000741	830212100		
41	8000742	830212100		
42	8000743	830212100		
43	8000744	830212100		
44	8000745	830212100		
45	8000746	830212100		
46	8000747	830212100		
47	8000748	830212100		
48	8000749	830212100		

Talla/Color	Rojo.		Categoría	€/ u.
	Ref.	Código		
36	8000724	830212200	SIP	82,43
37	8000725	830212200		
38	8000726	830212200		
39	8000727	830212200		
40	8000728	830212200		
41	8000729	830212200		
42	8000730	830212200		
43	8000731	830212200		
44	8000732	830212200		
45	8000733	830212200		
46	8000734	830212200		
47	8000735	830212200		
48	8000736	830212200		



ARGOS S3 REFLECTOR



- Puntera plástica anti-impactos 200J. - Planta textil antiperforación 1100N. - Suela Caucho doble densidad + PU. - Textil tecnológico de alta resistencia + lámina reflectante con una altísima capacidad de retroreflexión, la cual aporta mayor visibilidad en situaciones de baja luminosidad, combinado con PU flexible. - Deportivo de seguridad ALTA VISIBILIDAD. - Plantilla TRI TEC viscoelástica antiestática y antibacteriana. - Máxima flexibilidad. - Cierre mediante cordones y lengüeta almohadillada. - Certificado OEKO TEX, Standard 100. Los textiles utilizados están exentos de productos nocivos para las personas y/o medio ambiente. - Panter Technology TRI TEC. Tecnología viscoelástica que aporta máximo confort. Ralentiza la energía cinética del movimiento del pie para impulsar el siguiente paso. Alta resistencia a la abrasión, mantiene el pie seco y evita malos olores, sistema shock absorber en la zona de mayor impacto. - Panter Metal Free.

Talla/Color	Amarillo.		Categoría	€/ u.
	Ref.	Código		
37	8000751	830222500	S3	89,93
38	8000752	830222500		
39	8000753	830222500		
40	8000754	830222500		
41	8000755	830222500		
42	8000756	830222500		
43	8000757	830222500		
44	8000758	830222500		
45	8000759	830222500		
46	8000760	830222500		
47	8000761	830222500		
48	8000762	830222500		



07

Nairobi



- Puntera plástica anti-impactos 200J. - Planta textil antiperforación 1100N. - Suela contac PU+TPU, antideslizamiento extremo, SRC y shock absorber. - Plantilla termoconformada antiestática y antibacteriana. - Textil técnico ultra transpirable de alta tenacidad, escogido por su calidad, resistencia y gran transpiración y refuerzos de piel engomada en puntera y talón. - Sistema de cierre mediante cordones flexibles de máxima resistencia y lengüeta confort acolchada. - Horma Ancha y Ergonómica, se ajusta perfectamente al pie con extraordinaria comodidad, flexibilidad y estabilidad. - Panter Technology Optimal Sole. Calzado con mayor amortiguación y retorno de energía. Transforma la energía cinética de cada paso en impulso para el siguiente. Beneficios para el usuario: reparto óptimo de las presiones plantares, menor fatiga muscular, reducción dolor lumbar, menor riesgo de lesiones. - Certificado OEKO TEX, Standard 100. Los textiles utilizados están exentos de productos nocivos para las personas y/o medio ambiente. - Panter Metal Free. - Ideal para par su uso tanto dentro como fuera del trabajo.

Talla/Color	Verde.		Categoría	€ / u.
	Ref.	Código		
37	21088014	464511300	S3	74,93
38	21088015	464511300		
39	21088016	464511300		
40	21088017	464511300		
41	21088018	464511300		
42	21088019	464511300		
43	21088020	464511300		
44	21088021	464511300		
45	21088022	464511300		
46	21088023	464511300		
47	21088024	464511300		
48	21088025	464511300		



Diamante link S3



- Puntera plástica anti-impactos 200J. - Suela PU+PU Ergonomic. - Plantilla antiestática y antibacteriana. - Piel natural 1ª flor hidrófuga, muy transpirable. - Forro muy absorbente y resistente a la abrasión. - Cierre con cordones y lengüeta con fuelle. - Panter Technology Ergonomic. 1er Estudio Funcional de calzado profesional en confort y ergonomía. Aumento de confort y reducción de la fatiga y riesgo de lesiones. - Panter Technology Optimal Sole. Calzado con mayor amortiguación y retorno de energía. Transforma la energía cinética de cada paso en impulso para el siguiente. - Certificado OEKO TEX, Standard 100. Los textiles utilizados están exentos de productos nocivos para las personas y/o medio ambiente. - Panter Metal Free.

Talla/Color	Negro.		Categoría	€ / u.
	Ref.	Código		
35	8000610	446031700	S3	50,40
36	8000611	446031700		
37	8000612	446031700		
38	8000613	446031700		
39	8000614	446031700		
40	8000615	446031700		
41	8000616	446031700		
42	8000617	446031700		
43	8000618	446031700		
44	8000619	446031700		
45	8000620	446031700		
46	8000621	446031700		
47	8000622	446031700		
48	8000623	446031700		



Fragua link S3



- Bota para soldadores. - Puntera plástica anti-impactos 200J. - Suela PU+PU Ergonomic. - Plantilla antiestática y antibacteriana. - Piel natural 1ª flor hidrófuga, muy transpirable. - Forro muy absorbente y resistente a la abrasión. - Hebilla desprendimiento rápido. - Panter Technology Ergonomic. 1er Estudio Funcional de calzado profesional en confort y ergonomía. Aumento de confort y reducción de la fatiga y riesgo de lesiones. - Panter Technology Optimal Sole. Calzado con mayor amortiguación y retorno de energía. Transforma la energía cinética de cada paso en impulso para el siguiente. - Certificado OEKO TEX, Standard 100. Los textiles utilizados están exentos de productos nocivos para las personas y/o medio ambiente.

Talla/Color	Negro.		Categoría	€ / u.
	Ref.	Código		
35	8000625	447021700	S3	56,48
36	8000626	447021700		
37	8000627	447021700		
38	8000628	447021700		
39	8000629	447021700		
40	8000630	447021700		
41	8000631	447021700		
42	8000632	447021700		
43	8000633	447021700		
44	8000634	447021700		
45	8000635	447021700		
46	8000636	447021700		
47	8000637	447021700		
48	8000638	447021700		



07

Oslo



- Puntera plástica anti-impactos 200J. - Planta textil antiperforación 1100N. - Suela contac PU+TPU, antideslizamiento extremo, SRC y shock absorber. - Plantilla termoconformada antiestática y antibacteriana. - Piel natural 1ª flor hidrófuga y tejido transpirable. Materiales de la máxima calidad y tratamiento hidrófugo para repeler el agua. - Sistema de cierre mediante cordones flexibles de máxima resistencia y lengüeta confort acolchada. - Horma Ancha y Ergonómica, se ajusta perfectamente al pie con extraordinaria comodidad, flexibilidad y estabilidad. - Panter Technology Optimal Sole. Calzado con mayor amortiguación y retorno de energía. Transforma la energía cinética de cada paso en impulso para el siguiente. Beneficios para el usuario: reparto óptimo de las presiones plantares, menor fatiga muscular, reducción dolor lumbar, menor riesgo de lesiones. - Certificado OEKO TEX, Standard 100. Los textiles utilizados están exentos de productos nocivos para las personas y/o medio ambiente. - Panter Metal Free. - Ideal para par su uso tanto dentro como fuera del trabajo.

Talla/Color	Azul.		Categoría	€ / u.
	Ref.	Código		
37	21088027	463512100	S3	74,93
38	21088028	463512100		
39	21088029	463512100		
40	21088030	463512100		
41	21088031	463512100		
42	21088032	463512100		
43	21088033	463512100		
44	21088034	463512100		
45	21088035	463512100		
46	21088036	463512100		
47	21088037	463512100		
48	21088038	463512100		



Silex link S3



- Puntera plástica anti-impactos 200J. - Suela PU+PU Ergonomic. - Plantilla antiestática y antibacteriana. - Piel natural 1ª flor hidrófuga muy transpirable. - Forro muy absorbente y resistente a la abrasión. - Cierre con cordones y lengüeta con fuelle. - Panter Technology Ergonomic. 1er Estudio Funcional de calzado profesional en confort y ergonomía. Aumento de confort y reducción de la fatiga y riesgo de lesiones. - Panter Technology Optimal Sole. Calzado con mayor amortiguación y retorno de energía. Transforma la energía cinética de cada paso en impulso para el siguiente. - Certificado OEKO TEX, Standard 100. Los textiles utilizados están exentos de productos nocivos para las personas y/o medio ambiente. - Panter Metal Free.

Talla/Color	Negro.		Categoría	€ / u.
	Ref.	Código		
35	8000595	446031700	S3	54,53
36	8000596	446031700		
37	8000597	446031700		
38	8000598	446031700		
39	8000599	446031700		
40	8000600	446031700		
41	8000601	446031700		
42	8000602	446031700		
43	8000603	446031700		
44	8000604	446031700		
45	8000605	446031700		
46	8000606	446031700		
47	8000607	446031700		
48	8000608	446031700		



Sumun S3



- Puntera plástica anti-impactos 200J. - Planta textil antiperforación 1100N. - Suela PU+PU. - Plantilla antiestática y antibacteriana. - Piel serraje natural hidrofugado y cordura. Especial para ambientes calurosos. - Forro textil muy absorbente y resistente a la abrasión y al desgarro. - Cierre mediante cordones y lengüeta almohadillada con fuelle. - Panter Technology Optimal Sole. Calzado con mayor amortiguación y retorno de energía. Transforma la energía cinética de cada paso en impulso para el siguiente. Beneficios para el usuario: reparto óptimo de las presiones plantares, menor fatiga muscular, reducción dolor lumbar, menor riesgo de lesiones. - Certificado OEKO TEX, Standard 100. Los textiles utilizados están exentos de productos nocivos para las personas y/o medio ambiente. - Panter Metal Free.

Talla/Color	Beige.		Categoría	€ / u.	Talla/Color	Azul.		Categoría	€ / u.
	Ref.	Código				Ref.	Código		
35	8000639	492461400	S3	47,03	35	8000653	492462100	S3	47,03
36	8000640	492461400			36	8000654	492462100		
37	8000641	492461400			37	8000655	492462100		
38	8000642	492461400			38	8000656	492462100		
39	8000643	492461400			39	8000657	492462100		
40	8000644	492461400			40	8000658	492462100		
41	8000645	492461400			41	8000659	492462100		
42	8000646	492461400			42	8000660	492462100		
43	8000647	492461400			43	8000661	492462100		
44	8000648	492461400			44	8000662	492462100		
45	8000649	492461400			45	8000663	492462100		
46	8000650	492461400			46	8000664	492462100		
47	8000651	492461400			47	8000665	492462100		
48	8000652	492461400	48	8000666	492462100				



FORZA SPORTY



- NOVEDAD PANTER. Calzado de seguridad de estilo deportivo fabricado con la tecnología PANTER ARMOTEX, tejido tecnológico hidrofugado, transpirable y ultrarresistente, apto para todo tipo de trabajos. Más que un calzado un muro. Calzado más resistente y duradero. - 10 veces más resistente que los actuales materiales utilizados en condiciones extremas según la norma EN 388:2016. - Tejido tecnológico ARMOTEX. Transpirable e hidrófugo. Altísima resistencia a la abrasión, al uso diario y al desgarrar, alargando la vida útil del calzado. - Puntera de seguridad de aluminio, resistente a impactos 200J, súper ligera, ergonómica y confortable. - Planta textil antiperforación 1100N. - Suela fabricada en PU+PU. - Forro interior textil foamizado hipoalergénico de alta resistencia a la abrasión, absorbente de la humedad y altamente transpirable. - Collarín con diseño ergonómico almohadillado con espuma de poliuretano de alta densidad que favorece la movilidad y ajuste del pie. - Tirador trasero textil que facilita el calce. - Refuerzo de piel engomada en el talón, aporta más estabilidad, sujeción y confort. - Plantilla interior 100% ecológica, anatómica y con efecto memoria. Antibacterias, anti-estática y anti-hongos. - Panter Technology Optimal Sole. Calzado con mayor amortiguación y retorno de energía. Transforma la energía cinética de cada paso en impulso para el siguiente. Beneficios para el usuario: reparto óptimo de las presiones plantares, menor fatiga muscular, reducción dolor lumbar, menor riesgo de lesiones. - Certificado OEKO TEX, Standard 100. Los textiles utilizados están exentos de productos nocivos para las personas y/o medio ambiente.

Talla/Color	Negro.		Categoría	€ / u.	Talla/Color	Rojo.		Categoría	€ / u.
	Ref.	Código				Ref.	Código		
35	21088039	535201700	S3	74,93	35	21088053	535202200	S3	74,93
36	21088040	535201700			36	21088054	535202200		
37	21088041	535201700			37	21088055	535202200		
38	21088042	535201700			38	21088056	535202200		
39	21088043	535201700			39	21088057	535202200		
40	21088044	535201700			40	21088058	535202200		
41	21088045	535201700			41	21088059	535202200		
42	21088046	535201700			42	21088060	535202200		
43	21088047	535201700			43	21088061	535202200		
44	21088048	535201700			44	21088062	535202200		
45	21088049	535201700			45	21088063	535202200		
46	21088050	535201700			46	21088064	535202200		
47	21088051	535201700			47	21088065	535202200		
48	21088052	535201700			48	21088066	535202200		



VITA ECO



- NOVEDAD PANTER. Calzado de máxima seguridad de estilo deportivo fabricado con la tecnología PANTER ECOLÓGICA, la alternativa sostenible en calzado de seguridad. No solo te protege a ti, también al medio ambiente. - Calzado fabricado con materiales reciclados ligeros y resistentes al desgaste que aportan una gran capacidad adaptativa al pie, amortiguación y resistencia al deslizamiento. - Tejido reciclado, hidrofugado y transpirable. Altísima resistencia a la abrasión, al uso diario y al desgarrar, alargando la vida útil del calzado. - Puntera de seguridad de aluminio, resistente a impactos 200J, súper ligera, ergonómica y confortable. - Planta textil antiperforación 1100N. - Suela fabricada en PU+PU. - Forro interior textil foamizado hipoalergénico de alta resistencia a la abrasión, absorbente de la humedad y altamente transpirable. - Collarín con diseño ergonómico almohadillado con espuma de poliuretano de alta densidad que favorece la movilidad y ajuste del pie. - Tirador trasero textil que facilita el calce. - Refuerzo de microfibra en la puntera y el talón que aporta más estabilidad, sujeción y confort. - Plantilla interior 100% ecológica, anatómica y con efecto memoria. Antibacterias, anti-estática y anti-hongos. - Panter Technology Optimal Sole. Calzado con mayor amortiguación y retorno de energía. Transforma la energía cinética de cada paso en impulso para el siguiente. Beneficios para el usuario: reparto óptimo de las presiones plantares, menor fatiga muscular, reducción dolor lumbar, menor riesgo de lesiones. - Certificado OEKO TEX, Standard 100. Los textiles utilizados están exentos de productos nocivos para las personas y/o medio ambiente.

Talla/Color	Negro.		Categoría	€ / u.	Talla/Color	Verde.		Categoría	€ / u.
	Ref.	Código				Ref.	Código		
35	21088067	535211700	S3	74,93	35	21088081	535211300	S3	74,93
36	21088068	535211700			36	21088082	535211300		
37	21088069	535211700			37	21088083	535211300		
38	21088070	535211700			38	21088084	535211300		
39	21088071	535211700			39	21088085	535211300		
40	21088072	535211700			40	21088086	535211300		
41	21088073	535211700			41	21088087	535211300		
42	21088074	535211700			42	21088088	535211300		
43	21088075	535211700			43	21088089	535211300		
44	21088076	535211700			44	21088090	535211300		
45	21088077	535211700			45	21088091	535211300		
46	21088078	535211700			46	21088092	535211300		
47	21088079	535211700			47	21088093	535211300		
48	21088080	535211700			48	21088094	535211300		



07

Bota 2091 Especial Aislante



- Cobertura aislante 100%. - Bota especial contra riesgos eléctricos, certificada UNE-EN 50321:2000. - Puntera acero anti-impactos 200J. con tratamiento anticorrosión. - Planta acero antiperforación 1100N. con tratamiento anticorrosión. - Compuesto en PVC+ Caucho nitrilo. - Elevada resistencia a hidrocarburos y antigrasa. - Refuerzos de distintas densidades de material para evitar rozaduras en empeine, tobillos y talón. - Forro textil. - Certificado OEKO TEX, Standard 100. Los textiles utilizados están exentos de productos nocivos para las personas y/o medio ambiente.

Talla/Color	Naranja.		Categoría	€/ u.
	Ref.	Código		
39	1006981	320032417	SBP	36,00
40	1006982	320032417		
41	1006983	320032417		
42	1006984	320032417		
43	1006985	320032417		
44	1006986	320032417		
45	1006987	320032417		
46	1006988	320032417		
47	1006989	320032417		



Bota puntera 2090 alta verde



- Puntera acero anti-impactos 200J. - Compuesto en PVC virgen de altísima calidad. - Antigrasa, antiestática y elevada resistencia a hidrocarburos. - Refuerzos de distintas densidades de material y refuerzos exteriores en las zonas más expuestas a golpes (empeine, talón, frontal). - Suela antideslizante con resaltes y aislante al frío (Ci). - Sistema de absorción de energía en el talón (E). - Diseño de la suela ha sido desarrollado para procurar mayor resistencia a la abrasión y al desgaste, garantizando una mejor adherencia al suelo, evitando resbalamientos y caídas. - Malla interior textil con tratamiento antibacterias y antihongos, evitando la proliferación de microorganismos y las consecuencias de sus infecciones. - Certificado OEKO TEX, Standard 100. Los textiles utilizados están exentos de productos nocivos para las personas y/o medio ambiente.

Talla/Color	Verde.		Categoría	€/ u.
	Ref.	Código		
39	1008400	330031300	S4	17,25
40	1008401	330031300		
41	1008402	330031300		
42	1008403	330031300		
43	1008404	330031300		
44	1008405	330031300		
45	1008406	330031300		
46	1008407	330031300		
47	1008408	330031300		



Bota puntera y plantila alta verde 2091



- Puntera acero anti-impactos 200J. - Planta acero antiperforación 1100N. - Compuesto en PVC virgen de altísima calidad. - Antigrasa, antiestática y elevada resistencia a hidrocarburos. - Refuerzos de distintas densidades de material y refuerzos exteriores en las zonas más expuestas a golpes (empeine, talón, frontal). - Suela antideslizante con resaltes y aislante al frío (Ci). - Sistema de absorción de energía en el talón (E). - Diseño de la suela ha sido desarrollado para procurar mayor resistencia a la abrasión y al desgaste, garantizando una mejor adherencia al suelo, evitando resbalamientos y caídas. - Malla interior textil con tratamiento antibacterias y antihongos, evitando la proliferación de microorganismos y las consecuencias de sus infecciones. - Certificado OEKO TEX, Standard 100. Los textiles utilizados están exentos de productos nocivos para las personas y/o medio ambiente.

Talla/Color	Verde.		Categoría	€/ u.
	Ref.	Código		
39	1008500	320011315	S5	18,75
40	1008501	320011315		
41	1008502	320011315		
42	1008503	320011315		
43	1008504	320011315		
44	1008505	320011315		
45	1008506	320011315		
46	1008507	320011315		
47	1008508	320011315		



Bota puntera 2090 alta negro



- Puntera acero anti-impactos 200J. - Compuesto en PVC + caucho nitrilo. - Antigrasa, antiestática y elevada resistencia a hidrocarburos y productos químicos. - Refuerzos de distintas densidades de material y refuerzos exteriores en las zonas más expuestas a golpes (empeine, talón, frontal). - Suela antideslizante con resaltes y aislante al frío (Ci). - Sistema de absorción de energía en el talón (E). - Diseño de la suela ha sido desarrollado para procurar mayor resistencia a la abrasión y al desgaste, garantizando una mejor adherencia al suelo, evitando resbalamientos y caídas. - Malla interior textil con tratamiento antibacterias y antihongos, evitando la proliferación de microorganismos y las consecuencias de sus infecciones. - Certificado OEKO TEX, Standard 100. Los textiles utilizados están exentos de productos nocivos para las personas y/o medio ambiente.

Talla/Color	Negro.		Categoría	€ / u.
	Ref.	Código		
39	1008600	330011715	SB	22,35
40	1008601	330011715		
41	1008602	330011715		
42	1008603	330011715		
43	1008604	330011715		
44	1008605	330011715		
45	1008606	330011715		
46	1008607	330011715		
47	1008608	330011715		



Bota puntera y plantilla alta negro 2091



- Puntera acero anti-impactos 200J. - Planta acero antiperforación 1100N. - Compuesto en PVC + caucho nitrilo. - Antigrasa, antiestática y elevada resistencia a hidrocarburos. - Refuerzos de distintas densidades de material y refuerzos exteriores en las zonas más expuestas a golpes (empeine, talón, frontal). - Suela antideslizante con resaltes y aislante al frío (Ci). - Sistema de absorción de energía en el talón (E). - Diseño de la suela ha sido desarrollado para procurar mayor resistencia a la abrasión y al desgaste, garantizando una mejor adherencia al suelo, evitando resbalamientos y caídas. - Malla interior textil con tratamiento antibacterias y antihongos, evitando la proliferación de microorganismos y las consecuencias de sus infecciones. - Certificado OEKO TEX, Standard 100. Los textiles utilizados están exentos de productos nocivos para las personas y/o medio ambiente.

Talla/Color	Negro.		Categoría	€ / u.
	Ref.	Código		
39	1008700	320011715	SBP	26,99
40	1008701	320011715		
41	1008702	320011715		
42	1008703	320011715		
43	1008704	320011715		
44	1008705	320011715		
45	1008706	320011715		
46	1008707	320011715		
47	1008708	320011715		



Bota monocolor alta



- Compuesto en PVC virgen de altísima calidad. - Antigrasa, antiestática y elevada resistencia a hidrocarburos. - Refuerzos de distintas densidades de material y refuerzos exteriores en las zonas más expuestas a golpes (empeine, talón, frontal). - Suela antideslizante con resaltes y aislante al frío (Ci). - Sistema de absorción de energía en el talón (E). - Diseño de la suela ha sido desarrollado para procurar mayor resistencia a la abrasión y al desgaste, garantizando una mejor adherencia al suelo, evitando resbalamientos y caídas. - Malla interior textil con tratamiento antibacterias y antihongos, evitando la proliferación de microorganismos y las consecuencias de sus infecciones. - Certificado OEKO TEX, Standard 100. Los textiles utilizados están exentos de productos nocivos para las personas y/o medio ambiente. - Panter Metal Free.

Talla/Color	Verde.		Categoría	€ / u.
	Ref.	Código		
39	1008204	310011313	OB	13,65
40	1008205	310011313		
41	1008206	310011313		
42	1008207	310011313		
43	1008208	310011313		
44	1008209	310011313		
45	1008210	310011313		
46	1008211	310011313		12,60
47	1008212	310011313		
39	1008304	310011717		
40	1008305	310011717		
41	1008306	310011717		
42	1008307	310011717		
43	1008308	310011717		
44	1008309	310011717		
45	1008310	310011717		
46	1008311	310011717		
47	1008312	310011717		



Thor S3 Clase III Negro



- Bota de seguridad ANTICORTE en EN-ISO 17249 - Certificada para la protección contra cortes provocados por sierras de cadenas. Nivel de Riesgo: 3 - velocidad sierra: 28 m/s - Puntera acero anti-impactos 200J. - Planta textil antiperforación 1100N. - Suela caucho nitrilo resistente al calor por contacto directo hasta 300°C. - Plantilla antialórgica antiestática y antibacteriana. - Piel natural 1ª flor hidrófuga muy gruesa. - Incorpora un sistema de refuerzo y protección en la parte superior del maléolo compuesto por un contrafuerte ergonómico de material termoplástico que aporta rigidez impidiendo que se deforme la zona. - Acolchados interiores antiozaduras. - Cierre mediante cordones con un sistema rápido de lazada. - Panter Technology Optimal Sole. Calzado con mayor amortiguación y retorno de energía. Transforma la energía cinética de cada paso en impulso para el siguiente. Beneficios para el usuario: reparto óptimo de las presiones plantares, menor fatiga muscular, reducción dolor lumbar, menor riesgo de lesiones. - Certificado OEKO TEX, Standard 100. Los textiles utilizados están exentos de productos nocivos para las personas y/o medio ambiente.

Talla/Color	Negro.		Categoría	€/ u.
	Ref.	Código		
37	8000790	138391700	S3	127,50
38	8000791	138391700		
39	8000792	138391700		
40	8000793	138391700		
41	8000794	138391700		
42	8000795	138391700		
43	8000796	138391700		
44	8000797	138391700		
45	8000798	138391700		
46	8000799	138391700		
47	8000800	138391700		
48	8000801	138391700		



Fragua velcro totale S2 blanco 269



- Bota especialmente indicada para su uso en la industria cárnica, alimentaria y hostelería. - Puntera plástica anti-impactos 200J. - Suela PU+TPU, coeficiente de antideslizamiento máximo, SRC - Plantilla antiestática y antibacteriana. - Piel natural 1ª flor con tratamiento de hidrofugación especial. - Cierre mediante velcro industrial de alto rendimiento ajustable y solapa en piel. - Collarín almohadillado. - Puntera exterior reforzada que protege la piel y alarga la vida útil del calzado. - Panter Technology Vibatech. Protección antibacteriana, certificada que consigue eliminar más de 50 especies diferentes de bacterias al 99,99% (MRSA, ecoli, legionella, salmonella, campylobacter...) durante toda la vida útil del calzado. - Panter Technology Optimal Sole. Calzado con mayor amortiguación y retorno de energía. Transforma la energía cinética de cada paso en impulso para el siguiente. Beneficios para el usuario: reparto óptimo de las presiones plantares, menor fatiga muscular, reducción dolor lumbar, menor riesgo de lesiones. - Panter Technology Hidrogrip. Calzado resistente a la hidrólisis y agentes agresivos (lejía, amoníaco, aceites, grasas, sangre...) - Certificado OEKO TEX, Standard 100. Los textiles utilizados están exentos de productos nocivos para las personas y/o medio ambiente.

Talla/Color	Blanco.		Categoría	€/ u.
	Ref.	Código		
36	1007087	415101600	S2	50,78
37	1007088	415101600		
38	1007089	415101600		
39	1007090	415101600		
40	1007091	415101600		
41	1007092	415101600		
42	1007093	415101600		
43	1007094	415101600		
44	1007095	415101600		
45	1007096	415101600		
46	1007097	415101600		
47	1007098	415101600		
48	1007099	415101600		



Diamante velcro totale S2 blanco 269



- Zapato especialmente indicado para su uso en la industria cárnica, alimentaria y hostelería. - Puntera plástica anti-impactos 200J. - Suela PU+TPU, coeficiente de antideslizamiento máximo, SRC Plantilla antiestática y antibacteriana. - Piel natural 1ª flor con tratamiento de hidrofugación especial. - Cierre mediante velcro industrial de alto rendimiento ajustable y solapa en piel. - Panter Technology Vibatech. Protección antibacteriana, certificada que consigue eliminar más de 50 especies diferentes de bacterias al 99,99% (MRSA, ecoli, legionella, salmonella, campylobacter...) durante toda la vida útil del calzado. - Puntera exterior reforzada que protege la piel y alarga la vida útil del calzado. - Panter Technology Optimal Sole. Calzado con mayor amortiguación y retorno de energía. Transforma la energía cinética de cada paso en impulso para el siguiente. Beneficios para el usuario: reparto óptimo de las presiones plantares, menor fatiga muscular, reducción dolor lumbar, menor riesgo de lesiones. - Panter Technology Hidrogrip. Calzado resistente a la hidrólisis y agentes agresivos (lejía, amoníaco, aceites, grasas, sangre...) - Certificado OEKO TEX, Standard 100. Los textiles utilizados están exentos de productos nocivos para las personas y/o medio ambiente.

Talla/Color	Blanco.		Categoría	€ / u.
	Ref.	Código		
36	1007120	415091600	S2	48,90
37	1007121	415091600		
38	1007122	415091600		
39	1007123	415091600		
40	1007124	415091600		
41	1007125	415091600		
42	1007126	415091600		
43	1007127	415091600		
44	1007128	415091600		
45	1007129	415091600		
46	1007130	415091600		
47	1007131	415091600		
48	1007132	415091600		



Bota puntera. Alta blanco antigrasa 2090



- Puntera acero anti-impactos 200J. - PVC + Caucho nitrilo especial antiestático. Resistente a grasas. - Refuerzos de distintas densidades de material y refuerzos exteriores en las zonas más expuestas a golpes (empeine, talón, frontal). - Suela antideslizante con resaltes y aislante al frío (Ci). - Sistema de absorción de energía en el talón (E). - Diseño de la suela ha sido desarrollado para procurar mayor resistencia a la abrasión y al desgaste, garantizando una mejor adherencia al suelo, evitando resbalamientos y caídas. - Malla interior textil con tratamiento antibacterias y antihongos, evitando la proliferación de microorganismos y las consecuencias de sus infecciones. - Panter Technology Vibatech. Protección antibacteriana, certificada que consigue eliminar más de 50 especies diferentes de bacterias al 99,99% (MRSA, ecoli, legionella, salmonella, campylobacter...) durante toda la vida útil del calzado. - Panter Technology Hidrogrip. Calzado resistente a la hidrólisis y agentes agresivos (lejía, amoníaco, aceites, grasas, sangre...) - Certificado OEKO TEX, Standard 100. Los textiles utilizados están exentos de productos nocivos para las personas y/o medio ambiente.

Talla/Color	Blanco.		Categoría	€ / u.
	Ref.	Código		
39	1007151	330011616	S4	29,25
40	1007152	330011616		
41	1007153	330011616		
42	1007154	330011616		
43	1007155	330011616		
44	1007156	330011616		
45	1007157	330011616		
46	1007158	330011616		
47	1007159	330011616		



07

Merlot Sy Vp



- Bota ANTIBACTERIANA especialmente indicada para su uso en la industria cárnica, sectores sanitarios, hostelería, restauración, catering, etc. - Puntera plástica anti-impactos 200J. - Suela PU Hidrogrip, muy ligera y flexible. - Plantilla antiestática y antibacteriana. - Microfibra transpirable lavable en lavadora a 60°C, con tratamiento especial antigrasa. Resistente a grasas animales, vegetales y al suero de la sangre. - Forro interior absorbente y muy resistente al desgarro. - Panter Technology Ergonomic. 1er Estudio Funcional de calzado profesional en confort y ergonomía. Aumento de confort y reducción de la fatiga y riesgo de lesiones. - Panter Technology Vibatech. Protección antibacteriana, certificada que consigue eliminar más de 50 especies diferentes de bacterias al 99,99% (MRSA, ecoli, legionella, salmonella, campylobacter...) durante toda la vida útil del calzado. - Panter Technology Optimal Sole. Calzado con mayor amortiguación y retorno de energía. Transforma la energía cinética de cada paso en impulso para el siguiente. Beneficios para el usuario: reparto óptimo de las presiones plantares, menor fatiga muscular, reducción dolor lumbar, menor riesgo de lesiones. - Panter Technology Hidrogrip. Calzado resistente a la hidrólisis y agentes agresivos (lejía, amoníaco, aceites, grasas, sangre...) - Certificado OEKO TEX, Standard 100. Los textiles utilizados están exentos de productos nocivos para las personas y/o medio ambiente.

Talla/Color	Blanco.		Categoría	€ / u.
	Ref.	Código		
35	8000668	514723300	S2	42,38
36	8000669	514723300		
37	8000670	514723300		
38	8000671	514723300		
39	8000672	514723300		
40	8000673	514723300		
41	8000674	514723300		
42	8000675	514723300		
43	8000676	514723300		
44	8000677	514723300		
45	8000678	514723300		
46	8000679	514723300		
47	8000680	514723300		
48	8000681	514723300		



Zagros SY Hidrogrip Elastico



- Zapato ANTIBACTERIANO especialmente indicado para su uso en la industria cárnica, sectores sanitarios, hostelería, restauración, catering, etc. - Puntera plástica anti-impactos 200J. - Suela PU Hidrogrip, muy ligera y flexible. - Plantilla antiestática y antibacteriana. - Microfibra transpirable lavable en lavadora a 60°C, con tratamiento especial antigrasa. Resistente a grasas animales, vegetales y al suero de la sangre. - Forro interior absorbente y muy resistente al desgarro. - Velcro interior ajustable para mejor sujeción y ajuste. - Panter Technology Ergonomic. 1er Estudio Funcional de calzado profesional en confort y ergonomía. Aumento de confort y reducción de la fatiga y riesgo de lesiones. - Panter Technology Vibatech. Protección antibacteriana, certificada que consigue eliminar más de 50 especies diferentes de bacterias al 99,99% (MRSA, ecoli, legionella, salmonella, campylobacter...) durante toda la vida útil del calzado. - Puntera exterior reforzada que protege la piel y alarga la vida útil del calzado. - Panter Technology Optimal Sole. Calzado con mayor amortiguación y retorno de energía. Transforma la energía cinética de cada paso en impulso para el siguiente. Beneficios para el usuario: reparto óptimo de las presiones plantares, menor fatiga muscular, reducción dolor lumbar, menor riesgo de lesiones. - Panter Technology Hidrogrip. Calzado resistente a la hidrólisis y agentes agresivos (lejía, amoníaco, aceites, grasas, sangre...) - Certificado OEKO TEX, Standard 100. Los textiles utilizados están exentos de productos nocivos para las personas y/o medio ambiente.

Talla/Color	Blanco.		Categoría	€ / u.
	Ref.	Código		
35	8000683	519743300	S2	39,38
36	8000684	519743300		
37	8000685	519743300		
38	8000686	519743300		
39	8000687	519743300		
40	8000688	519743300		
41	8000689	519743300		
42	8000690	519743300		
43	8000691	519743300		
44	8000692	519743300		
45	8000693	519743300		
46	8000694	519743300		
47	8000695	519743300		
48	8000696	519743300		



Super Polar 168



- Bota para usuarios de cámaras frigoríficas, o trabajadores de cadenas de congelado. - Resistente al frío extremo hasta -40°C - Certificado de antideslizamiento sobre hielo. Máximo poder antideslizante sobre hielo y escarcha. - Puntera acero anti-impactos 200J. - PU + Caucho especial para caminar sobre hielo. - Piel natural 1ª flor hidrófuga. - Diseño sobreelevado en la puntera envuelve y refuerza las zonas de la piel más expuestas a golpes y rozaduras. - Incluye calcetín térmico intercambiable muy práctico e higiénico. - Panter Technology Optimal Sole. Calzado con mayor amortiguación y retorno de energía. Transforma la energía cinética de cada paso en impulso para el siguiente. Beneficios para el usuario: reparto óptimo de las presiones plantares, menor fatiga muscular, reducción dolor lumbar, menor riesgo de lesiones. - Certificado OEKO TEX, Standard 100. Los textiles utilizados están exentos de productos nocivos para las personas y/o medio ambiente.

Talla/Color	Negro.		Categoría	€ / u.
	Ref.	Código		
37	1022301	112231700	S2	123,75
38	1022302	112231700		
39	1022303	112231700		
40	1022304	112231700		
41	1022305	112231700		
42	1022306	112231700		
43	1022307	112231700		
44	1022308	112231700		
45	1022309	112231700		
46	1022310	112231700		
47	1022311	112231700		
48	1022312	112231700		



Zapato Urbano 81500



- Zapato de uso profesional con cordones. Es un calzado antifatiga, especial para profesionales que pasan mucho tiempo de pie. - Suela PU, resistente a grasas y aceites, así como aislante del frío/calor (Ci/Hi). - Plantilla termoconformada antiestática y antibacteriana. - Piel natural 1ª flor hidrófuga. - Cierre mediante cordones y lengüeta interior que evita la entrada en el pie de cuerpos extraños. - Certificado OEKO TEX, Standard 100. Los textiles utilizados están exentos de productos nocivos para las personas y/o medio ambiente.

Talla/Color	Negro.		Categoría	€ / u.
	Ref.	Código		
37	1007021	815001700	O2	50,93
38	1007022	815001700		
39	1007023	815001700		
40	1007024	815001700		
41	1007025	815001700		
42	1007026	815001700		
43	1007027	815001700		
44	1007028	815001700		
45	1007029	815001700		
46	1007030	815001700		
47	1007031	815001700		
48	1007032	815001700		



07

DAURIS SPORTY S3 NEGRO ESD



Calzado antifatiga. Textil tecnológico ARMOTEX® con tejido PUTEK. Transpirable e hidrófugo (WRU). Altísima resistencia a la abrasión, al uso diario y al desgarro. 10 veces más resistente que los actuales materiales utilizados en condiciones extremas. Testado según la Norma EN 388:2016. Certificado OEKO-TEX. Los tejidos utilizados para confeccionar este calzado están exentos de sustancias que puedan ser nocivas para las personas o el medio ambiente.

Lengüeta con fuelle de Tejido tecnológico ARMOTEX®, almohadillada. Transpirable e hidrófugo (WRU). Incorpora pasador textil en la parte superior que aporta estabilidad, sujeción y confort.

Collarín almohadillado con espuma de poliuretano de alta densidad que favorece la movilidad y el ajuste del pie.

Forro interior textil foamizado hipoalergénico de alta resistencia a la abrasión, absorbente de la humedad y altamente transpirable.

Suela fabricada en PU + PU ligera, flexible, resistente y antideslizante (SRC).

Nueva Tecnología "OPTIMAL SOLE". Mayor ligereza, estabilidad y aprovechamiento de la amortiguación en la pisada de entrada para impulsar el siguiente paso.

Puntera de seguridad aluminio anti-impactos 200J súper ligera, ergonómica y confortable.

Planta antiperforación textil 1100N flexible y ligera, fabricada con fibras especiales que le confieren una excelente resistencia a la perforación, cubriendo el 100% de la superficie plantar y con resultado de 0mm de perforación.

Plantilla interior anatómica 100% ecológica y reciclable. Extraíble, antibacterias, antiestática ESD y antihongos.

Sistema de cierre mediante cordones ecológicos e hidrofugados y gancho antióxido.

Calzado ESD. Protección frente a cargas electroestáticas.

Sellos Comfort y Funcional. Garantizan la comodidad y funcionalidad del calzado.

Talla/Color	Negro.		Categoría	€/ u.
	Ref.	Código		
36	2402148	534201700	S3	77,25
37	2402149	534201700		
38	2402150	534201700		
39	2402151	534201700		
40	2402152	534201700		
41	2402153	534201700		
42	2402154	534201700		
43	2402155	534201700		
44	2402156	534201700		
45	2402157	534201700		
46	2402158	534201700		
47	2402159	534201700		
48	2402160	534201700		
49	2402161	534201700		



Puntera de visita



- Puntera acoplable a cualquier tipo de calzado. - Resistente a impactos 200J. - Piel natural 1º flor hidrófuga. - Interior recubierto de un forro textil acolchado para mayor confort y protección del calzado de calle del usuario. - Ajuste con banda de piel con velcro de alta resistencia y refuerzo en la zona del talón para facilitar el ajuste y mejor el confort. - 3 tamaños disponibles: Pequeña: 36-40 / Mediana: 41-44 / Grande: 45-48.

Ref.	Código	Cubre las Tallas	Talla	€/ u.
1008850	80522	de 36 a 40	1	40,50
1008851	80520	de 41 a 44	2	40,50
1008852	80521	de 45 a 48	3	40,50



Caletín técnico Coolmax



Caletín de caña media (unos 23 cm.) diseñado especialmente para su uso con botas. Confeccionado principalmente con fibras COOLMAX. Se presentan las siguientes zonas: ELÁSTICO SUPERIOR destinado al ajuste y fijación del caletín a la pierna, evitando la formación de pliegues y rozaduras. ESCOTADURA: con canales de ventilación que facilita la flexión del pie. ZONAS DE DOBLE DENSIDAD que protege de rozaduras la puntera, la base del tendón y las partes inferior y trasera del pie. BANDA ELÁSTICA para un mejor ajuste y fijación del caletín al pie. CANALES DE VENTILACIÓN para proporcionar una mayor transpiración del pie.



Ref.	Código	Cubre las Tallas	€/ u.
1022449	80514	de 37 a 42	14,25

Cordon plano para bota



Cordón Negro Plano 1.10 metros para bota. Atadura de fibras e hilos de poliéster formando un cuerpo cilíndrico, plano, flexible y elástico, que se aplica para el cierre de las solapas de zapatos y botas.

Ref.	Código	€/ u.
8000802	80502	4,50



Plantilla suprema TRI-TEC emblistada



Sistema Shock Absorber, fruto de la colaboración entre IBV y el departamento I+D+i de Panter. Combina las zonas de absorción de impactos de la suela del zapato junto con el refuerzo insertado en la plantilla para amortiguar impactos y las cargas del peso en la pisada. Con el fin de repartir las presiones por igual en toda la zona plantar, la evolución de la planta es decreciente con distintas densidades y grosores desde la zona del talón a los dedos, con lo que consigue reducir las tensiones en pies, piernas y espalda, a lo largo de toda la jornada laboral, reduciendo la sensación de fatiga. La forma anatómica del talón y de la zona del puente potencian el confort, y junto a la cazoleta del talón, que recoge las partes llamadas "blandas" del talón para mejor ajuste y estabilidad. Absorbe, filtra y evapora el sudor gracias a los materiales de los que está fabricada. Estos materiales viscoelásticos, aprovechan la energía de cada pisada para impulsar el siguiente paso, consiguiendo así disminuir la fatiga al final de la jornada laboral. Incorpora materiales con un gran poder de ABSORCIÓN del sudor para mantener los pies siempre secos y con tratamiento especial fungicida y bactericida que reduce la incidencia de bacterias y hongos, evitando su proliferación y sus desagradables efectos.



Ref.	Código	Nº	€/ u.
8000804	8061	36	12,60
8000805	8061	37	12,60
8000806	8061	38	12,60
8000807	8061	39	12,60
8000808	8061	40	12,60
8000809	8061	41	12,60
8000810	8061	42	12,60

Ref.	Código	Nº	€/ u.
8000811	8061	43	12,60
8000812	8061	44	12,60
8000813	8061	45	12,60
8000814	8061	46	12,60
8000815	8061	47	12,60
8000816	8061	48	12,60

Cell



Suela: • Bidensidad Goma + EVA: Goma para conseguir una mayor resistencia térmica, resistencia a hidrocarburos y aldeslizamiento SRC. EVA para conseguir mayor ligereza y amortiguación. • Diseño de suela que aporta seguridad y resistencia: canales anchos, zonas de frenado, absorción de impactos. • Combinación de materiales y últimas tecnologías disponibles para conseguir una suela muy deportiva y ligera. CPU paramayor resistencia. • Collarín acolchado, lengüeta en fuelle EXTRA acolchada y plantilla interior conformada ergonómicamente para mayor comodidad y ajuste. • Forro EXTRA acolchado Bellota Mesh 3D: mejor ventilación y mayor comodidad. • Horma ancha.

Ref.	Código	Nº	€/ u.	Ref.	Código	Nº	€/ u.
1006090	72223B-38 S3	38	91,43	1006095	72223B-43 S3	43	91,43
1006091	72223B-39 S3	39	91,43	1006096	72223B-44 S3	44	91,43
1006092	72223B-40 S3	40	91,43	1006097	72223B-45 S3	45	91,43
1006093	72223B-41 S3	41	91,43	1006098	72223B-46 S3	46	91,43
1006094	72223B-42 S3	42	91,43	1006099	72223B-47 S3	47	91,43



07



Zapato Street



• Calzado certificado acorde al Reglamento (UE) 425/2016. Zapato de seguridad S1P. • Puntera de seguridad de aluminio amagnético y plantilla textil anti perforación no metálica. Suela: • Bidensidad: Goma + EVA: Goma para conseguir una mayor resistencia térmica a altas temperaturas HRO y con un alto coeficiente antideslizamiento SRC. EVA para conseguir mayor ligereza y amortiguación, absorción de impactos. • Diseño de suela exclusiva que aporta seguridad, resistente a aceites e hidrocarburos, aislamiento frente al frío (CI). Corte: • Microfibra + Mesh: ultra transpirables. • Forro, collarín y lengüeta tipo fuelle, EXTRA acolchados para una mayor comodidad y mejor ventilación. CI, Interior resistente a bajas temperaturas. • Plantilla interior conformada de espuma de célula abierta que proporciona un mayor confort y comodidad. Cosido antiestático. • Puntera y zona trasera anti abrasión para mayor resistencia a golpes y rozaduras. • Puntera de aluminio amagnética, extra ancha y ligera. • Mayor ligereza. • Puntera anti abrasión para mayor resistencia a golpes y rozaduras. Usos: • Para uso general en trabajos que necesiten calzado de seguridad. Confort, transpirabilidad y ligereza. • Especialmente indicado para trabajar en reposición, manipulación, industria.

Talla/Color	Ref.	Código	Categoría	€ / u.	Talla/Color	Ref.	Código	Categoría	€ / u.
Negro-Azul.					Negro-Rojo.				
38	21017040	72350BB-38S1P	S1P	71,08	36	21017050	72350BR36S1P	S1P	71,08
39	21017041	72350BB-39S1P			37	21017051	72350BR37S1P		
40	21017042	72350BB-40S1P			38	21017052	72350BR38S1P		
41	21017043	72350BB-41S1P			39	21017053	72350BR39S1P		
42	21017044	72350BB-42S1P			40	21017054	72350BR40S1P		
43	21017045	72350BB-43S1P			41	21017055	72350BR41S1P		
44	21017046	72350BB-44S1P			42	21017056	72350BR42S1P		
45	21017047	72350BB-45S1P			43	21017057	72350BR43S1P		
46	21017048	72350BB-46S1P			44	21017058	72350BR44S1P		
47	21017049	72350BB-47S1P			45	21017059	72350BR45S1P		
			46	21017060	72350BR46S1P				
			47	21017061	72350BR47S1P				



Zapato de seguridad Comp+ Nobuck



Zapato de seguridad Comp+ S3, con plantilla antiperforación textil y puntera de fibra de vidrio, en piel hidrofugada nobuck resistente a la penetración y absorción del agua, con suela y detalles en dos tonos de gris y elementos reflectantes en el talón de color naranja. De horma ancha, resulta cómodo, ligero y flexible. Para almacenaje, transporte, industria y construcción.

Talla/Color	Gris.		Categoría	€ / u.
	Ref.	Código		
39	2402163	72308GJ S3 39	S3	43,29
40	2402164	72308GJ S3 40		
41	2402165	72308GJ S3 41		
42	2402166	72308GJ S3 42		
43	2402167	72308GJ S3 43		
44	2402168	72308GJ S3 44		
45	2402169	72308GJ S3 45		
46	2402170	72308GJ S3 46		
47	2402171	72308GJ S3 47		



Bota de seguridad Comp+ Nobuck



Bota de seguridad Comp+ S3, con plantilla antiperforación textil y puntera de fibra de vidrio, en piel nobuck gris resistente a la penetración y absorción del agua, con suela y detalles en dos tonos de gris y elementos reflectantes en el talón de color naranja. De horma ancha, resulta cómoda, ligera y flexible. Para almacenaje, transporte, industria y construcción.

Talla/Color	Gris.		Categoría	€ / u.
	Ref.	Código		
39	2402173	72307GJ S3 39	S3	44,47
40	2402174	72307GJ S3 40		
41	2402175	72307GJ S3 41		
42	2402176	72307GJ S3 42		
43	2402177	72307GJ S3 43		
44	2402178	72307GJ S3 44		
45	2402179	72307GJ S3 45		
46	2402180	72307GJ S3 46		
47	2402181	72307GJ S3 47		



Bota All Track Petrol S3 con forro



Bota de seguridad All Track Petrol S3 con forro, con plantilla antiperforación textil y puntera de fibra de vidrio, piel marrón smooth action, con suela complete negra. Refuerzo en el talón con TPU. De horma ancha, resulta cómoda, ligera y flexible. Para uso en condiciones húmedas y/o secas, de uso industrial y/o trabajo. Resistente a la abrasión. Recomendado para uso petrolero y minería.

Talla/Color	Marrón.		Categoría	€ / u.
	Ref.	Código		
39	2402183	72321MN S3 39	S3	76,00
40	2402184	72321MN S3 40		
41	2402185	72321MN S3 41		
42	2402186	72321MN S3 42		
43	2402187	72321MN S3 38		
44	2402188	72321MN S3 44		
45	2402189	72321MN S3 45		
46	2402190	72321MN S3 46		
47	2402191	72321MN S3 47		



Bota de seguridad Click piel marrón



Bota de seguridad Click S3, con plantilla antiperforación textil y puntera de composite, en piel nobuk hidrofugada marrón resistente a la penetración y absorción del agua y detalles a contraste. Cierre rápido Click que se aprieta y suelta fácilmente. De horma ancha, cómoda, ligera y flexible, adecuada para uso en almacenes, industria y exterior.

Talla/Color	Marrón.		Categoría	€ / u.
	Ref.	Código		
39	2402193	72213-39 S3	S3	77,66
40	2402194	72213-40 S3		
41	2402195	72213-41 S3		
42	2402196	72213-42 S3		
43	2402197	72213-43 S3		
44	2402198	72213-44 S3		
45	2402199	72213-45 S3		
46	2402200	72213-46 S3		
47	2402201	72213-47 S3		



Zapatilla de seguridad Flex



Zapatilla de seguridad Flex Carbon S3, con plantilla antiperforación textil y puntera de fibra de vidrio ultraligera en piel action nobuck hidrofugado negro resistente a la penetración y absorción del agua. Incluye la nueva suela Bellota FLEX que se adapta a cualquier postura y la plantilla Confort+ para conseguir la mayor comodidad. Pensada para puestos de trabajo que requieran seguridad, resistencia y una estética neutra.

Talla/Color	Negro.		Categoría	€ / u.	Talla/Color	Negro.		Categoría	€ / u.
	Ref.	Código				Ref.	Código		
38	2402202	FTW0338BS3	S3	55,25	38	2402212	FTW0538BOSIP	S1P	56,39
39	2402203	FTW0339BS3			39	2402213	FTW0539BOSIP		
40	2402204	FTW0340BS3			40	2402214	FTW0540BOSIP		
41	2402205	FTW0341BS3			41	2402215	FTW0541BOSIP		
42	2402206	FTW0342BS3			42	2402216	FTW0542BOSIP		
43	2402207	FTW0343BS3			43	2402217	FTW0543BOSIP		
44	2402208	FTW0344BS3			44	2402218	FTW0544BOSIP		
45	2402209	FTW0345BS3			45	2402219	FTW0545BOSIP		
46	2402210	FTW0346BS3			46	2402220	FTW0546BOSIP		
47	2402211	FTW0347BS3	47	2402221	FTW0547BOSIP				



07

Comp+ Bota Piel Non Metal S3



Suela: SRC BIDENSIDAD PU + PU Material: piel Tipo de Calzado: Bota Puntera de seguridad no metálica Plantilla antiperforación no metálica Categoría S3: Resistente a la penetración y absorción de agua • Piel Serraje pigmentada resistente frente a la humedad. • Elemento con prestaciones relectantes para mayor seguridad. • Collarín acolchado, lengüeta en fuelle. • Forro acolchado Bellota Mesh: mejor ventilación y mayor comodidad. • Horma ancha.

Talla/Color	Negro.		Categoría	€/ u.
	Ref.	Código		
39	8000865	72307-39S3	S3	41,47
40	8000866	72307-40S3		
41	8000867	72307-41S3		
42	8000868	72307-42S3		
43	8000869	72307-43S3		
44	8000870	72307-44S3		
45	8000871	72307-45S3		
46	8000872	72307-46S3		
47	8000873	72307-47S3		



Bota Agro O2 WR



• Calzado certificado acorde al Reglamento (UE) 425/2016. Zapato O2-WR • Calzado de trabajo con membrana impermeable y costuras selladas. Suela: • Bidensidad Goma+EVA: Goma para conseguir una mayor resistencia térmica, resistencia a hidrocarburos y al deslizamiento. • EVA para conseguir mayor ligereza y amortiguación. • Diseño de suela que aporta seguridad y resistencia: canales anchos, zonas defrenado, absorción de impactos y perfiles elevados en puntera y trasera. • Inserto de TPU en el en franque para evitar la torsión del pie y dotar de estabilidad a la pisada. Corte: • Piel natural de alta calidad CrazyHorse, resistente y fuerte. • Pieza en TPU en la zona del tobillo para mayor protección y mejor sensación de ajuste. • Collarín EXTRA acolchado, lengüeta en fuelle EXTRA acolchada. Plantilla interior conformada de espuma de célula abierta que proporciona un mayor confort y comodidad. Cosido antiestático. • Forro EXTRA acolchado Bellota Mesh 3D: mejor ventilación y mayor comodidad. • Horma ancha. • Puntera anti-abrasión para mayor resistencia a golpes y rozaduras. Usos: • Para uso general en trabajos que necesiten calzado ocupacional sin seguridad (Sin puntera ni plantilla de seguridad). • Tecnología y diseño. • Especialmente indicado para trabajar en el exterior y ambientes húmedos: Outdoor, agricultura, jardinería y ganadería.

Talla/Color	Marrón.		Categoría	€/ u.
	Ref.	Código		
39	21017021	FTW01-39B02	O2 WR SRA	82,47
40	21017022	FTW01-40B02		
41	21017023	FTW01-41B02		
42	21017024	FTW01-42B02		
43	21017025	FTW01-43B02		
44	21017026	FTW01-44B02		
45	21017027	FTW01-45B02		
46	21017028	FTW01-46B02		
47	21017029	FTW01-47B02		



Comp+ Zapato Piel Non Metal



Suela: SRC BIDENSIDAD PU + PU Material: piel Tipo de Calzado: Bota Puntera de seguridad no metálica Plantilla antiperforación no metálica Categoría S3: Resistente a la penetración y absorción de agua • Piel Serraje pigmentada resistente frente a la humedad. • Elemento con prestaciones relectantes para mayor seguridad. • Collarín acolchado, lengüeta en fuelle. • Forro acolchado Bellota Mesh: mejor ventilación y mayor comodidad. • Horma ancha.

Talla/Color	Negro		Categoría	€/ u.	Talla/Color	Negro		Categoría	€/ u.
	Ref.	Código				Ref.	Código		
38	8000874	72308-38S3	S3	40,29	38	8000884	72309-38S1P	S1P	42,85
39	8000875	72308-39S3			39	8000885	72309-39S1P		
40	8000876	72308-40S3			40	8000886	72309-40S1P		
41	8000877	72308-41S3			41	8000887	72309-41S1P		
42	8000878	72308-42S3			42	8000888	72309-42S1P		
43	8000879	72308-43S3			43	8000889	72309-43S1P		
44	8000880	72308-44S3			44	8000890	72309-44S1P		
45	8000881	72308-45S3			45	8000891	72309-45S1P		
46	8000882	72308-46S3			46	8000892	72309-46S1P		
47	8000883	72308-47S3	47	8000893	72309-47S1P				



Bota Piel Soldador Comp+



• Calzado certificado acorde al Reglamento (UE) 425/2016. Zapato O2-WR • Calzado de trabajo con membrana impermeable y costuras selladas. Suela: • Bidensidad Goma+EVA: Goma para conseguir una mayor resistencia térmica, resistencia a hidrocarburos y al deslizamiento. • EVA para conseguir mayor ligereza y amortiguación. • Diseño de suela que aporta seguridad y resistencia: canales anchos, zonas defrenado, absorción de impactos y perfiles elevados en puntera y trasera. • Inserto de TPU en el franque para evitar la torsión del pie y dotar de estabilidad a la pisada. Corte: • Piel natural de alta calidad CrazyHorse, resistente y fuerte. • Pieza en TPU en la zona del tobillo para mayor protección y mejor sensación de ajuste. • Collarín EXTRA acolchado, lengüeta en fieltro EXTRA acolchada. Plantilla interior conformada de espuma de célula abierta que proporciona un mayor confort y comodidad. Cosido antiestático. • Forro EXTRA acolchado Bellota Mesh 3D: mejor ventilación y mayor comodidad. • Horma ancha. • Puntera anti-abrasión para mayor resistencia a golpes y rozaduras. Usos: • Para uso general en trabajos que necesiten calzado ocupacional sin seguridad (Sin puntera ni plantilla de seguridad). • Tecnología y diseño. • Especialmente indicado para trabajar en el exterior y ambientes húmedos: Outdoor, agricultura, jardinería y ganadería.

Talla/Color	Negro.		Categoría	€ / u.
	Ref.	Código		
39	21017031	72311-39S3	S3	44,29
40	21017032	72311-40S3		
41	21017033	72311-41S3		
42	21017034	72311-42S3		
43	21017035	72311-43S3		
44	21017036	72311-44S3		
45	21017037	72311-45S3		
46	21017038	72311-46S3		
47	21017039	72311-47S3		



Zapato Industry Negro S1P



• Calzado certificado acorde al Reglamento (UE) 425/2016. Zapato de seguridad S1P. • Puntera de seguridad de aluminio amagnético y plantilla textil anti perforación no metálica. Suela: • Bidensidad: Goma + EVA: Goma para conseguir una mayor resistencia térmica a altas temperaturas HRO y con un alto coeficiente antideslizamiento SRC. EVA para conseguir mayor ligereza y amortiguación, absorción de impactos. • Diseño de suela exclusiva que aporta seguridad, resistente a aceites e hidrocarburos, aislamiento frente al frío (CI). Corte: • Microibra + Mesh: ultra transpirables. • Forro, collarín y lengüeta tipo fieltro, EXTRA acolchados para una mayor comodidad y mejor ventilación. CI, Interior resistente a bajas temperaturas. • Plantilla interior conformada de espuma de célula abierta que proporciona un mayor confort y comodidad. Cosido antiestático. • Puntera y zona trasera anti abrasión para mayor resistencia a golpes y rozaduras. • Puntera de aluminio amagnética, extra ancha y ligera. • Mayor ligereza. • Puntera anti abrasión para mayor resistencia a golpes y rozaduras. Usos: • Para uso general en trabajos que necesiten calzado de seguridad. Confort, transpirabilidad y ligereza. • Especialmente indicado para trabajar en reposición, manipulación, industria.

Talla/Color	Negro.		Categoría	€ / u.
	Ref.	Código		
37	21017063	72351B37S1P	S1P	70,50
38	21017064	72351B38S1P		
39	21017065	72351B39S1P		
40	21017066	72351B40S1P		
41	21017067	72351B41S1P		
42	21017068	72351B42S1P		
43	21017069	72351B43S1P		
44	21017070	72351B44S1P		
45	21017071	72351B45S1P		
46	21017072	72351B46S1P		
47	21017073	72351B47S1P		



Roble



07

Bota de soldador, muy polivalente, diseñada sin costuras en la zona del empeine para alargar su vida útil. Fabricada con suela de PU2D, muy ligera, flexible y confortable. Amplio tallaje.

Talla/Color	Negro.		Categoría	€ / u.	Talla/Color	Negro.		Categoría	€ / u.
	Ref.	Código				Ref.	Código		
35	1003510	92001-35	S2	48,39	35	20015373	92002-35	S3	50,67
36	1003511	92001-36			36	20015374	92002-36		
37	1003512	92001-37			37	20015375	92002-37		
38	1003513	92001-38			38	20015376	92002-38		
39	1003514	92001-39			39	20015377	92002-39		
40	1003515	92001-40			40	20015378	92002-40		
41	1003516	92001-41			41	20015379	92002-41		
42	1003517	92001-42			42	20015380	92002-42		
43	1003518	92001-43			43	20015381	92002-43		
44	1003519	92001-44			44	20015382	92002-44		
45	1003520	92001-45			45	20015383	92002-45		
46	1003521	92001-46			46	20015384	92002-46		
47	1003522	92001-47			47	20015385	92002-47		
48	1003523	92001-48			48	20015386	92002-48		
49	1003524	92001-49			49	20015387	92002-49		
50	1003525	92001-50	50	20015388	92002-50				



Kira



Bota baja de seguridad, tipo soldador, cuello acolchado, con suela de poliuretano bidensidad.

Talla/Color	Blanco.		Categoría	€/ u.
	Ref.	Código		
37	2402223	90106-37	S2	46,46
38	2402224	90106-38		
39	2402225	90106-39		
40	2402226	90106-40		
41	2402227	90106-41		
42	2402228	90106-42		
43	2402229	90106-43		
44	2402230	90106-44		
45	2402231	90106-45		
46	2402232	90106-46		



Aliso



Zapato de seguridad, cuello acolchado y lengüeta, con suela de poliuretano bidensidad

Talla/Color	Blanco.		Categoría	€/ u.
	Ref.	Código		
37	2402234	90112-37	S2	43,37
38	2402235	90112-38		
39	2402236	90112-39		
40	2402237	90112-40		
41	2402238	90112-41		
42	2402239	90112-42		
43	2402240	90112-43		
44	2402241	90112-44		
45	2402242	90112-45		
46	2402243	90112-46		



Delfín



Zapato de seguridad, cuello acolchado, fuelle y lengüeta acolchada, con suela de poliuretano y caucho nitrilo antiestático. Su diseño incorpora la membrana de Gore-Tex proporcionando impermeabilidad, transpirabilidad y termorregulación.

Talla/Color	Negro.		Categoría	€/ u.
	Ref.	Código		
36	2402245	92202-36	S3	108,39
37	2402246	92202-37		
38	2402247	92202-38		
39	2402248	92202-39		
40	2402249	92202-40		
41	2402250	92202-41		
42	2402251	92202-42		
43	2402252	92202-43		
44	2402253	92202-44		
45	2402254	92202-45		
46	2402255	92202-46		
47	2402256	92202-47		
48	2402257	92202-48		



Tiburón



Bota de seguridad tipo trekking, cuello acolchado, fuelle y lengüeta acolchada, con suela de poliuretano y caucho nitrilo antiestático. Su diseño incorpora la membrana de Gore-Tex proporcionando impermeabilidad, transpirabilidad y termorregulación

Talla/Color	Negro.		Categoría	€ / u.
	Ref.	Código		
36	2402259	92201-36	S3	124,34
37	2402260	92201-37		
38	2402261	92201-38		
39	2402262	92201-39		
40	2402263	92201-40		
41	2402264	92201-41		
42	2402265	92201-42		
43	2402266	92201-43		
44	2402267	92201-44		
45	2402268	92201-45		
46	2402269	92201-46		
47	2402270	92201-47		
48	2402271	92201-48		



Pino



Bota de soldador, muy polivalente, diseñada sin costuras en la zona del empeine para alargar su vida útil. Fabricada con suela de PU+Caucho Nitrilo, ligera, flexible, confortable y resistente a altas temperaturas (300 °C). Amplio tallaje. Sistema anti torsión en suela.

Talla/Color	Negro.		Categoría	€ / u.	Talla/Color	Negro.		Categoría	€ / u.
	Ref.	Código				Ref.	Código		
35	1003630	92033-35	S2	58,22	35	20015831	92034-35	S3	60,48
36	1003631	92033-36			36	20015832	92034-36		
37	1003632	92033-37			37	20015833	92034-37		
38	1003633	92033-38			38	20015834	92034-38		
39	1003634	92033-39			39	20015835	92034-39		
40	1003635	92033-40			40	20015836	92034-40		
41	1003636	92033-41			41	20015837	92034-41		
42	1003637	92033-42			42	20015838	92034-42		
43	1003638	92033-43			43	20015839	92034-43		
44	1003639	92033-44			44	20015840	92034-44		
45	1003640	92033-45			45	20015841	92034-45		
46	1003641	92033-46			46	20015842	92034-46		
47	1003642	92033-47			47	20015843	92034-47		
48	1003643	92033-48	48	20015844	92034-48				
49	1003644	92033-49	49	20015845	92034-49				
50	1003645	92033-50	50	20015846	92034-50				



Haya



Bota de caña alta, que protege de posibles esguinces. Fabricada con suela de PU2D, muy ligera, flexible y confortable. Amplio tallaje.

Talla/Color	Negro.		Categoría	€ / u.	Talla/Color	Negro.		Categoría	€ / u.
	Ref.	Código				Ref.	Código		
35	1003530	92009-35	S2	46,72	35	20015485	92010-35	S3	48,97
36	1003531	92009-36			36	20015486	92010-36		
37	1003532	92009-37			37	20015487	92010-37		
38	1003533	92009-38			38	20015488	92010-38		
39	1003534	92009-39			39	20015489	92010-39		
40	1003535	92009-40			40	20015490	92010-40		
41	1003536	92009-41			41	20015491	92010-41		
42	1003537	92009-42			42	20015492	92010-42		
43	1003538	92009-43			43	20015493	92010-43		
44	1003539	92009-44			44	20015494	92010-44		
45	1003540	92009-45			45	20015495	92010-45		
46	1003541	92009-46			46	20015496	92010-46		
47	1003542	92009-47			47	20015497	92010-47		
48	1003543	92009-48	48	20015498	92010-48				
49	1003544	92009-49	49	20015499	92010-49				
50	1003545	92009-50	50	20015500	92010-50				



Castaño



Zapato blucher, ligero, flexible y muy confortable. Suela de PU2D, muy ligera, flexible y confortable. Amplio tallaje.

Talla/Color	Negro.		Categoría	€ / u.	Talla/Color	Negro.		Categoría	€ / u.
	Ref.	Código				Ref.	Código		
35	1003550	92021-35	S2	43,10	35	20015613	92022-35	S3	44,54
36	1003551	92021-36			36	20015614	92022-36		
37	1003552	92021-37			37	20015615	92022-37		
38	1003553	92021-38			38	20015616	92022-38		
39	1003554	92021-39			39	20015617	92022-39		
40	1003555	92021-40			40	20015618	92022-40		
41	1003556	92021-41			41	20015619	92022-41		
42	1003557	92021-42			42	20015620	92022-42		
43	1003558	92021-43			43	20015621	92022-43		
44	1003559	92021-44			44	20015622	92022-44		
45	1003560	92021-45			45	20015623	92022-45		
46	1003561	92021-46			46	20015624	92022-46		
47	1003562	92021-47			47	20015625	92022-47		
48	1003563	92021-48			48	20015626	92022-48		
49	1003564	92021-49			49	20015627	92022-49		
50	1003565	92021-50	50	20015628	92022-50				



Palmera



Bota tobillera con piel serraje, consiguiendo un alto nivel de transpiración. Diseño del corte enterizo, sin costuras laterales, que alargan la su vida útil. Fabricada con suela de PU2D, muy ligera, flexible y confortable.

Talla/Color	Azul.		Categoría	€ / u.	Talla/Color	Azul.		Categoría	€ / u.
	Ref.	Código				Ref.	Código		
35	1003570	92015-35	S1	46,01	35	20015549	92016-35	S1+P	48,35
36	1003571	92015-36			36	20015550	92016-36		
37	1003572	92015-37			37	20015551	92016-37		
38	1003573	92015-38			38	20015552	92016-38		
39	1003574	92015-39			39	20015553	92016-39		
40	1003575	92015-40			40	20015554	92016-40		
41	1003576	92015-41			41	20015555	92016-41		
42	1003577	92015-42			42	20015556	92016-42		
43	1003578	92015-43			43	20015557	92016-43		
44	1003579	92015-44			44	20015558	92016-44		
45	1003580	92015-45			45	20015559	92016-45		
46	1003581	92015-46			46	20015560	92016-46		
47	1003582	92015-47			47	20015561	92016-47		
48	1003583	92015-48			48	20015562	92016-48		
49	1003584	92015-49			49	20015563	92016-49		
50	1003585	92015-50	50	20015564	92016-50				



Comp+ Zapato Serraje Non Metal S1P



Suela: SRC BIDENSIDAD PU + PU Material: piel Tipo de Calzado: Bota Puntera de seguridad no metálica Plantilla antiperforación no metálica
 - Piel serraje afelpada: más transpirable y ligero. - Elemento con prestaciones relectantes para mayor seguridad. - Collarín acolchado, lengüeta en fieltro. - Forro acolchado Bellota Mesh: mejor ventilación y mayor comodidad. - Horma ancha

Talla/Color	Negro.		Categoría	€ / u.
	Ref.	Código		
39	8000895	72310-39S1P	S1P	41,67
40	8000896	72310-40S1P		
41	8000897	72310-41S1P		
42	8000898	72310-42S1P		
43	8000899	72310-43S1P		
44	8000900	72310-44S1P		
45	8000901	72310-45S1P		
46	8000902	72310-46S1P		
47	8000903	72310-47S1P		



NEXT POWER GTX B301



Bota baja de seguridad, fabricada en nubuck de alta calidad. Su diseño incorpora la membrana de Gore-Tex proporcionando impermeabilidad, transpirabilidad y termorregulación.

Talla/Color	Verde.		Categoría	€ / u.
	Ref.	Código		
35	2402272	92597-35	S3	124,34
36	2402273	92597-36		
37	2402274	92597-37		
38	2402275	92597-38		
39	2402276	92597-39		
40	2402277	92597-40		
41	2402278	92597-41		
42	2402279	92597-42		
43	2402280	92597-43		
44	2402281	92597-44		
45	2402282	92597-45		
46	2402283	92597-46		
47	2402284	92597-47		
48	2402285	92597-48		



NEXT POWER GTX B101



Bota baja fabricada en piel flor vacuna de alta calidad. Su diseño incorpora la membrana de Gore-Tex proporcionando impermeabilidad, transpirabilidad y termorregulación.

Talla/Color	Negro.		Categoría	€ / u.
	Ref.	Código		
35	2402286	92598-35	S3	169,89
36	2402287	92598-36		
37	2402288	92598-37		
38	2402289	92598-38		
39	2402290	92598-39		
40	2402291	92598-40		
41	2402292	92598-41		
42	2402293	92598-42		
43	2402294	92598-43		
44	2402295	92598-44		
45	2402296	92598-45		
46	2402297	92598-46		
47	2402298	92598-47		
48	2402299	92598-48		



NEXT AIR S201



Zapato de seguridad que aporta máxima protección y confort. Fabricado en tejido poliéster hidrofugado, transpirable y muy resistente a la abrasión y al desgarrado.

Talla/Color	Azul.		Categoría	€ / u.
	Ref.	Código		
35	2402300	92584-35	S3	98,84
36	2402301	92584-36		
37	2402302	92584-37		
38	2402303	92584-38		
39	2402304	92584-39		
40	2402305	92584-40		
41	2402306	92584-41		
42	2402307	92584-42		
43	2402308	92584-43		
44	2402309	92584-44		
45	2402310	92584-45		
46	2402311	92584-46		
47	2402312	92584-47		
48	2402313	92584-48		



07

NEXT AIR B201



Bota baja de seguridad que aporta máxima protección y confort. Fabricada en tejido poliéster,transpirable y muy resistente a la abrasión y al desgarro.

Talla/Color	Negro.		Categoria	€ / u.
	Ref.	Código		
35	2402314	92586-35	S3	105,09
36	2402315	92586-36		
37	2402316	92586-37		
38	2402317	92586-38		
39	2402318	92586-39		
40	2402319	92586-40		
41	2402320	92586-41		
42	2402321	92586-42		
43	2402322	92586-43		
44	2402323	92586-44		
45	2402324	92586-45		
46	2402325	92586-46		
47	2402326	92586-47		
48	2402327	92586-48		



NEXT AIR S501



Calzado profesional de seguridad con un atractivo diseño sport. Fabricado en tejido poliéster hidrofugado,transpirable y muy resistente a la abrasión.

Talla/Color	Negro.		Categoria	€ / u.
	Ref.	Código		
35	2402328	92589-35	S3	104,69
36	2402329	92589-36		
37	2402330	92589-37		
38	2402331	92589-38		
39	2402332	92589-39		
40	2402333	92589-40		
41	2402334	92589-41		
42	2402335	92589-42		
43	2402336	92589-43		
44	2402337	92589-44		
45	2402338	92589-45		
46	2402339	92589-46		
47	2402340	92589-47		
48	2402341	92589-48		



Acebo



Zapato tipo Oxford de serraje, muy deportivo, por su extremada ligereza, comodidad y confortabilidad. Elevado poder de transpiración.

Talla/Color	Azul.		Categoria	€ / u.	Talla/Color	Azul.		Categoria	€ / u.
	Ref.	Código				Ref.	Código		
35	1003610	92017-35	S1	42,60	35	20015565	92018-35	S1+P	43,66
36	1003611	92017-36			36	20015566	92018-36		
37	1003612	92017-37			37	20015567	92018-37		
38	1003613	92017-38			38	20015568	92018-38		
39	1003614	92017-39			39	20015569	92018-39		
40	1003615	92017-40			40	20015570	92018-40		
41	1003616	92017-41			41	20015571	92018-41		
42	1003617	92017-42			42	20015572	92018-42		
43	1003618	92017-43			43	20015573	92018-43		
44	1003619	92017-44			44	20015574	92018-44		
45	1003620	92017-45			45	20015575	92018-45		
46	1003621	92017-46			46	20015576	92018-46		
47	1003622	92017-47			47	20015577	92018-47		
48	1003623	92017-48			48	20015578	92018-48		
49	1003624	92017-49	49	20015579	92018-49				
50	1003625	92017-50	50	20015580	92018-50				



Cedro



Zapato tipo mocasín con cierre mediante elásticos de alta tenacidad. 100 % Metal Free. Fabricado con suela PU2D, 30 % más ligera. Diseño y fabricación acorde a estudios basados en la Biomecánica aplicada en el calzado de atletismo. Sistema anti torsión en suela.

Talla/Color	Negro.		Categoría	€ / u.
	Ref.	Código		
35	1003650	92049-35	S2	43,67
36	1003651	92049-36		
37	1003652	92049-37		
38	1003653	92049-38		
39	1003654	92049-39		
40	1003655	92049-40		
41	1003656	92049-41		
42	1003657	92049-42		
43	1003658	92049-43		
44	1003659	92049-44		
45	1003660	92049-45		
46	1003661	92049-46		
47	1003662	92049-47		
48	1003663	92049-48		

Talla/Color	Negro.		Categoría	€ / u.
	Ref.	Código		
35	20016035	92050-35	S3	47,23
36	20016036	92050-36		
37	20016037	92050-37		
38	20016038	92050-38		
39	20016039	92050-39		
40	20016040	92050-40		
41	20016041	92050-41		
42	20016042	92050-42		
43	20016043	92050-43		
44	20016044	92050-44		
45	20016045	92050-45		
46	20016046	92050-46		
47	20016047	92050-47		
48	20016048	92050-48		



Acebo CM



100 % Metal Free. Fabricado con suela PU2D, 30 % más ligera. Diseño y fabricación acorde a estudios basados en la Biomecánica aplicada en el calzado de atletismo. Extremadamente ligero, cómodo y confortable. Sistema anti torsión en suela.

Talla/Color	Azul.		Categoría	€ / u.
	Ref.	Código		
35	1003665	92053-35	S1	44,46
36	1003666	92053-36		
37	1003667	92053-37		
38	1003668	92053-38		
39	1003669	92053-39		
40	1003670	92053-40		
41	1003671	92053-41		
42	1003672	92053-42		
43	1003673	92053-43		
44	1003674	92053-44		
45	1003675	92053-45		
46	1003676	92053-46		
47	1003677	92053-47		
48	1003678	92053-48		

Talla/Color	Azul.		Categoría	€ / u.
	Ref.	Código		
35	20016049	92054-35	S1+P	47,52
36	20016050	92054-36		
37	20016051	92054-37		
38	20016052	92054-38		
39	20016053	92054-39		
40	20016054	92054-40		
41	20016055	92054-41		
42	20016056	92054-42		
43	20016057	92054-43		
44	20016058	92054-44		
45	20016059	92054-45		
46	20016060	92054-46		
47	20016061	92054-47		
48	20016062	92054-48		



Acebo fresh



100 % Metal Free. Fabricado con suela PU2D, 30 % más ligera. Diseño y fabricación acorde a estudios basados en la Biomecánica aplicada en el calzado de atletismo. Elevado poder de transpiración, gracias a la combinación de materiales. Extremadamente ligero, cómodo y confortable. Sistema anti torsión en suela.

Talla/Color	Azul.		Categoría	€ / u.
	Ref.	Código		
35	1003680	92059-35	S2	54,29
36	1003681	92059-36		
37	1003682	92059-37		
38	1003683	92059-38		
39	1003684	92059-39		
40	1003685	92059-40		
41	1003686	92059-41		
42	1003687	92059-42		
43	1003688	92059-43		
44	1003689	92059-44		
45	1003690	92059-45		
46	1003691	92059-46		
47	1003692	92059-47		
48	1003693	92059-48		

Talla/Color	Azul.		Categoría	€ / u.
	Ref.	Código		
35	20016119	92060-35	S3	57,85
36	20016120	92060-36		
37	20016121	92060-37		
38	20016122	92060-38		
39	20016123	92060-39		
40	20016124	92060-40		
41	20016125	92060-41		
42	20016126	92060-42		
43	20016127	92060-43		
44	20016128	92060-44		
45	20016129	92060-45		
46	20016130	92060-46		
47	20016131	92060-47		
48	20016132	92060-48		



07



Enebro



100 % Metal Free. Fabricado con suela PU2D, 30 % más ligera. Diseño y fabricación acorde a estudios basados en la Biomecánica aplicada en el calzado de atletismo. Extremadamente ligero, cómodo y confortable. Sistema anti torsión en suela.

Talla/Color	Negro.		Categoría	€/ u.	Talla/Color	Negro.		Categoría	€/ u.
	Ref.	Código				Ref.	Código		
35	1003710	92063-35	S2	46,48	35	20016133	92064-35	S3	52,13
36	1003711	92063-36			36	20016134	92064-36		
37	1003712	92063-37			37	20016135	92064-37		
38	1003713	92063-38			38	20016136	92064-38		
39	1003714	92063-39			39	20016137	92064-39		
40	1003715	92063-40			40	20016138	92064-40		
41	1003716	92063-41			41	20016139	92064-41		
42	1003717	92063-42			42	20016140	92064-42		
43	1003718	92063-43			43	20016141	92064-43		
44	1003719	92063-44			44	20016142	92064-44		
45	1003720	92063-45			45	20016143	92064-45		
46	1003721	92063-46			46	20016144	92064-46		
47	1003722	92063-47			47	20016145	92064-47		
48	1003723	92063-48			48	20016146	92064-48		



Carpe



Bota tobillera, acolchada en la zona de los tobillos. 100 % Metal Free. Fabricado con suela PU2D, 30 % más ligera. Diseño y fabricación acorde a estudios basados en la Biomecánica aplicada en el calzado de atletismo. Elevado poder de transpiración. Extremadamente ligero, cómodo y confortable. Sistema anti torsión en suela.

Talla/Color	Negro.		Categoría	€/ u.	Talla/Color	Negro.		Categoría	€/ u.
	Ref.	Código				Ref.	Código		
35	1003725	92067-35	S2	53,99	35	20016147	92068-35	S3	59,40
36	1003726	92067-36			36	20016148	92068-36		
37	1003727	92067-37			37	20016149	92068-37		
38	1003728	92067-38			38	20016150	92068-38		
39	1003729	92067-39			39	20016151	92068-39		
40	1003730	92067-40			40	20016152	92068-40		
41	1003731	92067-41			41	20016153	92068-41		
42	1003732	92067-42			42	20016154	92068-42		
43	1003733	92067-43			43	20016155	92068-43		
44	1003734	92067-44			44	20016156	92068-44		
45	1003735	92067-45			45	20016157	92068-45		
46	1003736	92067-46			46	20016158	92068-46		
47	1003737	92067-47			47	20016159	92068-47		
48	1003738	92067-48			48	20016160	92068-48		



Ébano velcro



Bota soldador, acolchada en la zona de los tobillos y lengüeta. 100 % Metal Free. Fabricado con suela PU2D, 30 % más ligera. Diseño y fabricación acorde a estudios basados en la Biomecánica aplicada en el calzado de atletismo. Elevado poder de transpiración, con ventanas en zona de tobillos. Extremadamente ligero, cómodo y confortable. Sistema anti torsión en suela.

Talla/Color	Negro.		Categoría	€/ u.
	Ref.	Código		
37	20016190	92078-37	S3	56,66
38	20016191	92078-38		
39	20016192	92078-39		
40	20016193	92078-40		
41	20016194	92078-41		
42	20016195	92078-42		
43	20016196	92078-43		
44	20016197	92078-44		
45	20016198	92078-45		
46	20016199	92078-46		
47	20016200	92078-47		
48	20016201	92078-48		



Inca



Zapato tipo sport, 100 % Metal Free, fabricado con suela PU2D, 30 % más ligera. Diseño y fabricación acorde a estudios basados en la Biomecánica aplicada en el calzado de atletismo. Elevado poder de transpiración, gracias a la combinación de serrajes, nobuck y elementos textiles. Extremadamente ligero, cómodo y confortable. Sistema anti torsión en suela. Muy polivalente, para interiores y exteriores, estaciones frías y cálidas, pero sobre todo, ambientes con calurosos.

Talla/Color	Marrón.		Categoría	€ / u.	Talla/Color	Marrón.		Categoría	€ / u.
	Ref.	Código				Ref.	Código		
36	20016202	92079-36	S2	55,04	36	20016233	92080-36	S3	58,71
37	20016203	92079-37			37	20016234	92080-37		
38	20016204	92079-38			38	20016235	92080-38		
39	1003759	92079-39			39	20016236	92080-39		
40	1003760	92079-40			40	20016237	92080-40		
41	1003761	92079-41			41	20016238	92080-41		
42	1003762	92079-42			42	20016239	92080-42		
43	1003763	92079-43			43	20016240	92080-43		
44	1003764	92079-44			44	20016241	92080-44		
45	1003765	92079-45			45	20016242	92080-45		
46	1003766	92079-46			46	20016243	92080-46		
47	1003767	92079-47			47	20016244	92080-47		
48	1003768	92079-48	48	20016245	92080-48				



Granado



Zapato tipo sport, 100 % Metal Free, fabricado con suela PU2D, 30 % más ligera. Diseño y fabricación acorde a estudios basados en la Biomecánica aplicada en el calzado de atletismo. Elevado poder de transpiración, gracias a la combinación de serrajes, nobuck y elementos textiles. Extremadamente ligero, cómodo y confortable. Sistema anti torsión en suela. Muy polivalente, para interiores y exteriores, estaciones frías y cálidas, pero sobre todo, ambientes con calurosos.

Talla/Color	Negro-Gris-Azul.		Categoría	€ / u.
	Ref.	Código		
37	20016262	92088-37	S3	59,28
38	20016263	92088-38		
39	20016264	92088-39		
40	20016265	92088-40		
41	20016266	92088-41		
42	20016267	92088-42		
43	20016268	92088-43		
44	20016269	92088-44		
45	20016270	92088-45		
46	20016271	92088-46		
47	20016272	92088-47		
48	20016273	92088-48		



Cerezo



Bota cierre Velcro, sector alimentación. 100 % Metal Free. Suela PU2D, 30 % más ligera. Diseño y fabricación acorde a estudios basados en la Biomecánica aplicada en el calzado de atletismo. Sistema anti torsión en suela.

Talla/Color	Blanco.		Categoría	€ / u.
	Ref.	Código		
36	1003861	92146-36	S2	55,37
37	1003862	92146-37		
38	1003863	92146-38		
39	1003864	92146-39		
40	1003865	92146-40		
41	1003866	92146-41		
42	1003867	92146-42		
43	1003868	92146-43		
44	1003869	92146-44		
45	1003870	92146-45		
46	1003871	92146-46		
47	1003872	92146-47		
48	1003873	92146-48		



07



Nogal



Zapato tipo mocasin, cierre mediante elásticos de alta tenacidad. 100 % Metal Free. Suela PU2D, 30 % más ligera. Diseño y fabricación acorde a estudios basados en la Biomecánica aplicada en el calzado de atletismo. Sistema anti torsión en suela.

Talla/Color	Blanco.		Categoría	€ / u.
	Ref.	Código		
36	1003876	92150-36	S2	47,18
37	1003877	92150-37		
38	1003878	92150-38		
39	1003879	92150-39		
40	1003880	92150-40		
41	1003881	92150-41		
42	1003882	92150-42		
43	1003883	92150-43		
44	1003884	92150-44		
45	1003885	92150-45		
46	1003886	92150-46		
47	1003887	92150-47		
48	1003888	92150-48		



Arpón



Bota con membrana GORE - TEX®, lo que dota al calzado de impermeabilidad duradera, alta transpirabilidad y óptimo confort climático, manteniendo los pies secos y protegidos. 100 % Metal Free. Diseño de corte enterizo, sin costuras laterales, que alargan su vida útil. Suela de PU2D, con sistema anti torsión, muy ligera, flexible y confortable, cuyo diseño y fabricación, está avalado mediante estudios basado en la Biomecánica aplicada en el calzado de atletismo.

Talla/Color	Marrón.		Categoría	€ / u.
	Ref.	Código		
36	1004011	92192-36	S3	133,47
37	1004012	92192-37		
38	1004013	92192-38		
39	1004014	92192-39		
40	1004015	92192-40		
41	1004016	92192-41		
42	1004017	92192-42		
43	1004018	92192-43		
44	1004019	92192-44		
45	1004020	92192-45		
46	1004021	92192-46		
47	1004022	92192-47		
48	1004023	92192-48		



Barbo



Bota baja o tobillera con membrana GORE - TEX®, que dota al calzado de impermeabilidad duradera, alta transpirabilidad y óptimo confort climático, manteniendo los pies secos y protegidos. Suela de PU+Caucho Nitrilo, ligera, flexible, confortable y resistente a altas temperaturas (300 °C). Sistema anti torsión en suela.

Talla/Color	Marrón.		Categoría	€ / u.	Talla/Color	Marrón.		Categoría	€ / u.
	Ref.	Código				Ref.	Código		
35	1004025	90302-35	S2	130,22	35	20017549	90306-35	S3	132,50
36	1004026	90302-36			36	20017550	90306-36		
37	1004027	90302-37			37	20017551	90306-37		
38	1004028	90302-38			38	20017552	90306-38		
39	1004029	90302-39			39	20017553	90306-39		
40	1004030	90302-40			40	20017554	90306-40		
41	1004031	90302-41			41	20017555	90306-41		
42	1004032	90302-42			42	20017556	90306-42		
43	1004033	90302-43			43	20017557	90306-43		
44	1004034	90302-44			44	20017558	90306-44		
45	1004035	90302-45			45	20017559	90306-45		
46	1004036	90302-46			46	20017560	90306-46		
47	1004037	90302-47			47	20017561	90306-47		
48	1004038	90302-48	48	20017562	90306-48				
49	1004039	90302-49	49	20017563	90306-49				
50	1004040	90302-50	50	20017564	90306-50				



Dascilus



Bota con membrana GORE - TEX®, que dota al calzado de impermeabilidad duradera, alta transpirabilidad y óptimo confort climático, manteniendo los pies secos y protegidos. Diseño de corte enterizo, sin costuras laterales, que alargan su vida útil. Suela de PU+Caucho Nitrilo, ligera, flexible, confortable y resistente a altas temperaturas (300 °C). Sistema anti torsión en suela.

Talla/Color	Negro/Azul.		Categoría	€ / u.	Talla/Color	Negro/Azul.		Categoría	€ / u.
	Ref.	Código				Ref.	Código		
35	1004045	90276-35	S2	137,52	35	20017504	90279-35	S3	139,81
36	1004046	90276-36			36	20017505	90279-36		
37	1004047	90276-37			37	20017506	90279-37		
38	1004048	90276-38			38	20017507	90279-38		
39	1004049	90276-39			39	20017508	90279-39		
40	1004050	90276-40			40	20017509	90279-40		
41	1004051	90276-41			41	20017510	90279-41		
42	1004052	90276-42			42	20017511	90279-42		
43	1004053	90276-43			43	20017512	90279-43		
44	1004054	90276-44			44	20017513	90279-44		
45	1004055	90276-45			45	20017514	90279-45		
46	1004056	90276-46			46	20017515	90279-46		
47	1004057	90276-47			47	20017516	90279-47		
48	1004058	90276-48			48	20017517	90279-48		
49	1004059	90276-49			49	20017518	90279-49		
50	1004060	90276-50	50	20017519	90279-50				



Ficus



Calzado deportivo de seguridad para uso industrial. Material reflectante en el corte para mejorar la visibilidad por la noche.

Talla/Color	Negro/Verde.		Categoría	€ / u.
	Ref.	Código		
36	20016248	92315-36	S3	63,42
37	20016249	92315-37		
38	20016250	92315-38		
39	20016251	92315-39		
40	20016252	92315-40		
41	20016253	92315-41		
42	20016254	92315-42		
43	20016255	92315-43		
44	20016256	92315-44		
45	20016257	92315-45		
46	20016258	92315-46		
47	20016259	92315-47		
48	20016260	92315-48		



HEXAGON BLUE



Zapato de seguridad con cuello acolchado y lengüeta acolchada. Suela de poliuretano bidensidad antiestática.

Talla/Color	Azul.		Categoría	€ / u.
	Ref.	Código		
36	2402343	92542-36	S3	72,03
37	2402344	92542-37		
38	2402345	92542-38		
39	2402346	92542-39		
40	2402347	92542-40		
41	2402348	92542-41		
42	2402349	92542-42		
43	2402350	92542-43		
44	2402351	92542-44		
45	2402352	92542-45		
46	2402353	92542-46		
47	2402354	92542-47		
48	2402355	92542-48		



07





Laurel Black

Calzado deportivo de seguridad para uso industrial. Material reflectante en el corte para mejorar la visibilidad por la noche.

Talla/Color	Negro.		Categoría	€/ u.
	Ref.	Código		
37	8001829	92317-37	S3	72,88
38	8001830	92317-38		
39	8001831	92317-39		
40	8001832	92317-40		
41	8001833	92317-41		
42	8001834	92317-42		
43	8001835	92317-43		
44	8001836	92317-44		
45	8001837	92317-45		
46	8001838	92317-46		
47	8001839	92317-47		
48	8001840	92317-48		



Bota no metálica Nervión



Entresuela, poliuretano antiestático expandido. Suela, poliuretano antiestático compacto color azul.

Talla/Color	Negro.		Categoría	€/ u.
	Ref.	Código		
36	8004900	NERVION S3-36	S3	28,08
37	8004901	NERVION S3-37		
38	8004902	NERVION S3-38		
39	8004903	NERVION S3-39		
40	8004904	NERVION S3-40		
41	8004905	NERVION S3-41		
42	8004906	NERVION S3-42		
43	8004907	NERVION S3-43		
44	8004908	NERVION S3-44		
45	8004909	NERVION S3-45		
46	8004910	NERVION S3-46		
47	8004911	NERVION S3-47		
48	8004912	NERVION S3-48		



Bota soldador con hebilla Aneto



Entresuela, poliuretano antiestático expandido. Suela, poliuretano antiestático compacto color azul.

Talla/Color	Negro.		Categoría	€/ u.
	Ref.	Código		
36	8004956	ANETO S3-36	S3	25,84
37	8004957	ANETO S3-37		
38	8004958	ANETO S3-38		
39	8004959	ANETO S3-39		
40	8004960	ANETO S3-40		
41	8004961	ANETO S3-41		
42	8004962	ANETO S3-42		
43	8004963	ANETO S3-43		
44	8004964	ANETO S3-44		
45	8004965	ANETO S3-45		
46	8004966	ANETO S3-46		
47	8004967	ANETO S3-47		
48	8004968	ANETO S3-48		



Bota soldador con velcro Veleta



Entresuela, poliuretano antiestático expandido. Suela, poliuretano antiestático compacto color azul.

Talla/Color	Negro.		Categoría	€ / u.	
	Ref.	Código			
36	8004970	VELETA S3-36	S3	25,84	
37	8004971	VELETA S3-37			
38	8004972	VELETA S3-38			
39	8004973	VELETA S3-39			
40	8004974	VELETA S3-40			
41	8004975	VELETA S3-41			
42	8004976	VELETA S3-42			
43	8004977	VELETA S3-43			
44	8004978	VELETA S3-44			
45	8004979	VELETA S3-45			
46	8004980	VELETA S3-46			
47	8004981	VELETA S3-47			
48	8004982	VELETA S3-48			S1P



Zapato serraje Moncayo



Entresuela, poliuretano antiestático expandido. Suela, poliuretano antiestático compacto color azul.

Talla/Color	Gris.		Categoría	€ / u.
	Ref.	Código		
37	8004984	MONCAYO S1P-37	S1P	25,32
38	8004985	MONCAYO S1P-38		
39	8004986	MONCAYO S1P-39		
40	8004987	MONCAYO S1P-40		
41	8004988	MONCAYO S1P-41		
42	8004989	MONCAYO S1P-42		
43	8004990	MONCAYO S1P-43		
44	8004991	MONCAYO S1P-44		
45	8004992	MONCAYO S1P-45		
46	8004993	MONCAYO S1P-46		
47	8004994	MONCAYO S1P-47		
48	8004995	MONCAYO S1P-48		



Zapato no metálico Tajo



Entresuela, poliuretano antiestático expandido. Suela, poliuretano antiestático compacto color azul.

Talla/Color	Negro.		Categoría	€ / u.
	Ref.	Código		
36	8004914	TAJO S3-36	S3	28,08
37	8004915	TAJO S3-37		
38	8004916	TAJO S3-38		
39	8004917	TAJO S3-39		
40	8004918	TAJO S3-40		
41	8004919	TAJO S3-41		
42	8004920	TAJO S3-42		
43	8004921	TAJO S3-43		
44	8004922	TAJO S3-44		
45	8004923	TAJO S3-45		
46	8004924	TAJO S3-46		
47	8004925	TAJO S3-47		
48	8004926	TAJO S3-48		



07

Bota metálica Teide



Entresuela, poliuretano antiestático expandido. Suela, poliuretano antiestático compacto color azul.

Talla/Color	Negro.		Categoría	€ / u.
	Ref.	Código		
36	8004928	TEIDE S3-36	S3	23,08
37	8004929	TEIDE S3-37		
38	8004930	TEIDE S3-38		
39	8004931	TEIDE S3-39		
40	8004932	TEIDE S3-40		
41	8004933	TEIDE S3-41		
42	8004934	TEIDE S3-42		
43	8004935	TEIDE S3-43		
44	8004936	TEIDE S3-44		
45	8004937	TEIDE S3-45		
46	8004938	TEIDE S3-46		
47	8004939	TEIDE S3-47		
48	8004940	TEIDE S3-48		



Zapato metálico Gorbea



Entresuela, poliuretano antiestático expandido. Suela, poliuretano antiestático compacto color azul.

Talla/Color	Negro.		Categoría	€ / u.
	Ref.	Código		
36	8004942	GORBEA S3-36	S3	23,08
37	8004943	GORBEA S3-37		
38	8004944	GORBEA S3-38		
39	8004945	GORBEA S3-39		
40	8004946	GORBEA S3-40		
41	8004947	GORBEA S3-41		
42	8004948	GORBEA S3-42		
43	8004949	GORBEA S3-43		
44	8004950	GORBEA S3-44		
45	8004951	GORBEA S3-45		
46	8004952	GORBEA S3-46		
47	8004953	GORBEA S3-47		
48	8004954	GORBEA S3-48		



Bota Trekking S3 no metálica Urola



Bota Trekking no metálica, puntera fibra de vidrio y plantilla textil antipenetración. Suela PU/PU. Membrana waterproof.

Talla/Color	Negro.		Categoría	€ / u.
	Ref.	Código		
38	21104030	UROLA-38	S3	58,90
39	21104031	UROLA-39		
40	21104032	UROLA-40		
41	21104033	UROLA-41		
42	21104034	UROLA-42		
43	21104035	UROLA-43		
44	21104036	UROLA-44		
45	21104037	UROLA-45		
46	21104038	UROLA-46		



ZAPATO SINEX TURIA S3 SRC



Empeine: Bajo en tejido en malla transpirable + KPU(Elastómero de poliuretano de solidificación rápida)
 Puntera: composite
 Lámina antiperforación: Textil
 Suela: PU Antideslizante (SRC)
 Plus: Metal free. Membrana resistente al agua

Ref.	Código	Nº	€/u.	Ref.	Código	Nº	€/u.
40079994	3300SA-36	36	51,50	40080001	3300SA-43	43	51,50
40079995	3300SA-37	37	51,50	40080002	3300SA-44	44	51,50
40079996	3300SA-38	38	51,50	40080003	3300SA-45	45	51,50
40079997	3300SA-39	39	51,50	40080004	3300SA-46	46	51,50
40079998	3300SA-40	40	51,50	40080005	3300SA-47	47	51,50
40079999	3300SA-41	41	51,50	40080006	3300SA-48	48	51,50
40080000	3300SA-42	42	51,50				



Arnés anticaídas



Ref.	Código	Descripción	Modelo	€/u.
1008904	2651027200	Cintas de poliéster de 47 mm. Reguladores de longitud en pecho y piernas. 2 puntos de enganche: un anticaídas dorsal y otro de sujeción frontal	27-C	70,67
1008905	2651028200	Cintas de poliéster de 45 mm. Reguladores de longitud en piernas. Punto de enganche anticaídas dorsal	28-C	52,82
1108906	2651010200	Arnés anticaídas. Conector tipo mosquetón mod. 30. Incluye cuerda de 1,5 mts.	10 Basic	36,74
2402356	2651010400		ARNES CLIMAX 10 BASIC PLUS	29,86
1008907	2651044200	Arnés rotativo. Acolchamiento en banda de cintura y perneras. Hebillas de rápida actuación en banda de cintura, perneras y en cierre pectoral.	Rota Confort	208,14
1008911	2651043100	Acolchamiento en banda de cintura y perneras. Hebillas de rápida actuación en banda de cintura, perneras y en cierre pectoral	Atlas	231,44
1008912	2651021100	2 puntos de anclaje con hebillas D: Dorsal y Frontal. Material: Cinta de poliéster de 47 mm. Ajustable de brazo y pierna. Hebillas de rápida actuación. EN 361	21-C Atex	73,33
1008913	2651252100	2 puntos de anclaje anticaídas (dorsal y frontal) y uno de sujeción lateral, por dos hebillas abatibles	Maxipro	44,61
1008914	2651258320	Versión del 21-C tratado con Pyrovatex, proporciona la máxima protección contra el calor y las llamas ofreciendo una comodidad elevada.	21-C Ignifugo	208,50

07



Arnés anticaídas



Ref.	Código	Descripción	€/u.
1009320	14002	Arnés HT22 M	66,00
1009322	44112	Arnés HT4	85,00
1009323	77992	Eslinga LDAD 1,5m 10-53-54	120,00



77992



14002

44112

Arnés anticaídas VELETA



Arnés diseñado para ser utilizado en todos los ámbitos de los trabajos en altura. EN 358:1999 (cinturón) EN 361:2002 (arnés anticaídas)

Ref.	Código	€/u.
2402357	2651052100	113,50



Arnés anticaídas ATLAS RESCUE



El arnés anticaídas Atlas Rescue es un equipo de protección individual indicado para los trabajos en altura, especialmente para operaciones de rescate. Normas: EN 1497 (rescate) EN 358:1999 (cinturón) EN 361:2002 (arnés anticaídas) EN 813: 2008 (arnés de asiento)

Ref.	Código	€/u.
2402358	2651043950	307,73



Arnés anticaídas MAXIPRO DIELECTRICO



El arnés anticaídas MAXIPRO DIELECTRICO es un equipo de protección individual indicado para trabajos en los que exista un riesgo de caída y un riesgo eléctrico. EN 358: 1999 (cinturón de sujeción) EN 361: 2002 (arnés anticaídas)

Ref.	Código	€/u.
2402359	2651252700	81,62



Arnés anticaídas LIGHT PLUS



Arnés anticaídas ligero y de larga duración. Dispone de una anilla anticaídas dorsal con cinta de extensión y dos anillas textiles anticaídas frontales. También incluye cintas regulables en pecho y pernera.

Todos los componentes metálicos están fabricados en acero cincado de alta resistencia, ofreciendo una durabilidad en el tiempo excelente.

NFC ready: Incorpora la nueva tecnología Irucheck NFC



Ref.	Código	TALLA	€/u.
2402360	100404500016	S-M	26,50
2402361	100404500004	L-XL	26,50
2402362	100404500033	UNICA	32,30
2402363	100404500017	S-M	52,40
2402364	100404500005	L-XL	52,40



Anticaídas APENINOS



Arnés anticaídas profesional y ultraresistente al deterioro. Dispone de una anilla anticaídas dorsal con cinta de extensión y otra anilla anticaídas frontal. También incluye cintas regulables en altura y pernera. ¡Novedad! Ahora incorpora el nuevo acolchado ligero y resistente con tejido RipStop en espalda y hombros. Equipado con 3 hebillas de ajuste rápido K-Easy Las anillas de anclaje están fabricadas en aluminio ligero, mientras que las hebillas de ajuste manuales y las hebillas automáticas K-Easy están fabricadas en acero cincado de alta resistencia, ofreciendo una durabilidad en el tiempo excelente.

El arnés está equipado con el exclusivo sistema de recogida de cintas Antislip-System desarrollado por Irudek.

Se incluye una bolsa de transporte Irusack 10 impermeable, evitando humedades y suciedades del equipo. NFC ready: Incorpora la nueva tecnología Irucheck NFC



Ref.	Código	TALLA	€ / u.
2402365	100908300014	S-M	56,80
2402366	100908300001	L-XL	56,80
2402367	100908300015	XXL-XXXL	56,80

Anticaídas HIMALAYA ECO



Arnés anticaídas Con cintura, profesional y ultrarresistente al deterioro. Dispone de una anilla anticaídas dorsal con cinta de extensión y otra anilla anticaídas frontal. También incluye cintas regulables en altura, pernera y cintura.

Esté arnés está fabricado junto al cinturón Expert-3D desarrollado con piezas 3D técnicamente diseñadas para un confort absoluto. Incorpora dos anillas laterales de posicionamiento y 4 cintas sujeta-material.

¡Novedad! Ahora incorpora el nuevo acolchado ligero y resistente con tejido RipStop en espalda, hombros y cinturón.

Las anillas de anclaje están fabricadas en aluminio ligero, mientras que las hebillas de ajuste manuales están fabricadas en acero cincado de alta resistencia, ofreciendo una durabilidad en el tiempo excelente

El arnés está equipado con el exclusivo sistema de recogida de cintas Antislip-System desarrollado por Irudek.

Se incluye una bolsa de transporte Irusack 10 impermeable, evitando humedades y suciedades del equipo.



NFC ready: Incorpora la nueva tecnología Irucheck NFC

Ref.	Código	TALLA	€ / u.
2402368	100908400008	UNICA	32,00

Anticaídas DOLOMITAS



Arnés anticaídas Con cintura, profesional y ultraresistente al deterioro. Dispone de una anilla anticaídas dorsal con cinta de extensión y otra anilla anticaídas frontal. También incluye cintas regulables en altura, pernera y cintura.

Esté arnés está fabricado junto al cinturón Expert-3D desarrollado con piezas 3D técnicamente diseñadas para un confort absoluto. Incorpora dos anillas laterales de posicionamiento y 3 cintas sujeta-material.

¡Novedad! Ahora incorpora el nuevo acolchado ligero y resistente con tejido RipStop en espalda, hombros y cinturón.

Equipado con 4 hebillas de ajuste rápido K-EasyLas anillas de anclaje están fabricadas en aluminio ligero, mientras que las hebillas de ajuste manuales están fabricadas en acero cincado de alta resistencia, ofreciendo una durabilidad en el tiempo excelente

El arnés está equipado con el exclusivo sistema de recogida de cintas Antislip-System desarrollado por Irudek.

Se incluye una bolsa de transporte Irusack 10 impermeable, evitando humedades y suciedades del equipo.

NFC ready: Incorpora la nueva tecnología Irucheck NFC



Ref.	Código	TALLA	€ / u.
2402369	100908400001	UNICA	42,10

07



Anticaídas ROQUE NUBLO

Uno de los Arnés anticaídas más populares de Irudek, gracias a su versatilidad y resistencia al deterioro.

Fabricado junto al cinturón Expert-3D desarrollado con piezas 3D técnicamente diseñadas para un confort absoluto. El arnés está equipado con el exclusivo sistema de recogida de cintas Antislip-System desarrollado por Irudek.

Las anillas de anclaje están fabricadas en aluminio ligero, mientras que las hebillas de ajuste manuales están fabricadas en acero cincado de alta resistencia, ofreciendo una durabilidad en el tiempo excelente

Dispone de:

- Anilla anticaídas dorsal
- Anilla anticaídas frontal
- Dos anillas laterales de posicionamiento
- Una cinta ventral para descensores o trabajos verticales (para adaptar con bloqueador ventral de ascenso Irudek Krow)
- Cintas regulables en altura, pernera y cintura.
- 4 hebillas de ajuste rápido K-Easy
- Se incluye una bolsa de transporte Irusack 10 impermeable, evitando humedades y suciedades del equipo.



NFC ready: Incorpora la nueva tecnología Irucheck NFC.

¡Novedad! Ahora incorpora el nuevo acolchado ligero y resistente con tejido RipStop en espalda, hombros y cinturón.

Ref.	Código	TALLA	€ / u.
2402370	100908400010	S-M	44,50
2402371	100908400005	L-XXL	44,50
2402372	100908400011	XXL-XXXX	44,50

Anticaídas EXPERT PRO



Ref.	Código	Descripción	TALLA	€ / u.
2402373	100403400027	Arnés anticaídas profesional y ultrarresistente al deterioro. Dispone de una anilla anticaídas dorsal con cinta de extensión y otra anilla anticaídas frontal. También incluye cintas regulables en altura y pernera. Ahora incorpora el nuevo acolchado ligero y resistente con tejido RipStop en espalda y hombros.	S-M	89,10
2402374	100403400028	Arnés anticaídas profesional y ultrarresistente al deterioro. Dispone de una anilla anticaídas dorsal con cinta de extensión y otra anilla anticaídas frontal. También incluye cintas regulables en altura y pernera. Ahora incorpora el nuevo acolchado ligero y resistente con tejido RipStop en espalda y hombros.	L-XXL	89,10
2402375	100403400002	Arnés anticaídas Con cintura, profesional y ultrarresistente al deterioro. Dispone de una anilla anticaídas dorsal con cinta de extensión y otra anilla anticaídas frontal. También incluye cintas regulables en altura, pernera y cintura.	S-M	104,60
2402376	100403400001	Arnés anticaídas Con cintura, profesional y ultrarresistente al deterioro. Dispone de una anilla anticaídas dorsal con cinta de extensión y otra anilla anticaídas frontal. También incluye cintas regulables en altura, pernera y cintura.	L-XXL	104,60
2402377	100403400004	Arnés anticaídas Con cintura, profesional y ultrarresistente al deterioro. Dispone de una anilla anticaídas dorsal con cinta de extensión y otra anilla anticaídas frontal. También incluye cintas regulables en altura, pernera y cintura.	S-M	140,30
2402378	100403400003	Esté arnés está fabricado junto al cinturón Expert-3D desarrollado con piezas 3D técnicamente diseñadas para un confort absoluto. Incorpora dos anillas laterales de posicionamiento y 3 cintas sujeta-material.	L-XXL	140,30
2402379	100403400021	Uno de los Arnés anticaídas más populares de Irudek, gracias a su versatilidad y resistencia al deterioro. Fabricado junto al cinturón Expert-3D desarrollado con piezas 3D técnicamente diseñadas para un confort absoluto. El arnés está equipado con el exclusivo sistema de recogida de cintas Antislip-System desarrollado por Irudek. Las anillas de anclaje están fabricadas en aluminio ligero, mientras que las hebillas de ajuste manuales están fabricadas en acero cincado de alta resistencia, ofreciendo una durabilidad en el tiempo excelente	S-M	195,90
2402380	100403400022	Uno de los Arnés anticaídas más populares de Irudek, gracias a su versatilidad y resistencia al deterioro. Fabricado junto al cinturón Expert-3D desarrollado con piezas 3D técnicamente diseñadas para un confort absoluto. El arnés está equipado con el exclusivo sistema de recogida de cintas Antislip-System desarrollado por Irudek. Las anillas de anclaje están fabricadas en aluminio ligero, mientras que las hebillas de ajuste manuales están fabricadas en acero cincado de alta resistencia, ofreciendo una durabilidad en el tiempo excelente	L-XXL	195,90

Absorbedor ABE 361-C



Presentamos nuestra amplia gama de absorbedores de energía con cuerda, con diferentes terminaciones y longitudes. Absorbedores diseñados para soportar caídas, reduciendo el impacto a menos de 6kN.

Además, los modelos bifurcados han sido diseñados conforme a la VG11.063:2014, test de resistencia adicional para absorbedores de energía con 2 cuerdas bifurcadas.



Ref.	Código	Longitud m	€ / u.
2402381	100102200026	1.7	36,50

Absorbedor ABE 362/140



Absorbedor de energía con cuerda y gancho de 50mm de acero diseñado para soportar caídas, reduciendo el impacto de caída a menos de 6kN.

Están equipados con chip Irucheck NFC, para una eficaz gestión e inspección del equipo.



Ref.	Código	Longitud m	€ / u.
2402382	100102200002	1.40	49,40

Absorbedor ABE 363/180



Absorbedor de energía con cuerda bifurcada y ganchos de 50mm de acero diseñado para soportar caídas, reduciendo el impacto de caída a menos de 6kN.

Están equipados con chip Irucheck NFC, para una eficaz gestión e inspección del equipo.



Ref.	Código	Longitud m	€ / u.
2402383	100102200003	1.8	64,80

Absorbedor ABE 397/180



Estos absorbedores de energía con cinta elástica de poliéster (45mm) han sido diseñados para ofrecer mayor comodidad y mayor resistencia de los equipos, gracias a su función elástica y retráctil.



Ref.	Código	Longitud m	€ / u.
2402384	100102800003	1.8	54,50

Absorbedor ABE 398/180



Estos absorbedores de energía con cinta elástica de poliéster (45mm) han sido diseñados para ofrecer mayor comodidad y mayor resistencia de los equipos, gracias a su función elástica y retráctil.



Ref.	Código	Longitud m	€ / u.
2402385	100102800004	1.8	86,20

Absorbedor de energía



Ref.	Código	Modelo	Descripción	€/ u.
1009103	2702003200	31-A	Longitud total: 1,85. Material: tejido 47 mm. EN 355	22,30
1009149	2702003300	32-A	Longitud total: 35 cm. EN 355	18,93
1009151	2702003804	N.50	Absorbedor de energía con elemento de amarre elástico. Longitud total 1,75 m. Incluye un conector del modelo 31, diámetro de abertura 54 mm. y uno del modelo 32, con diámetro de abertura de 19 mm.	82,88
1009152	2702003805	N.51-Y	Absorbedor de energía con elemento de amarre elástico en Y. Longitud total 1,75 m. Incluye dos conectores del modelo 31, diámetro de abertura 54 mm. y uno del modelo 32, con diámetro de abertura de 19 mm.	121,46
1009153	2702100600	35 SEMI	Elemento de amarre en Y fabricado con cuerda de poliamida. Se suministra en diferentes longitudes, según ámbito de trabajo y exposición del operario	80,38
1009154	2702003500	34-A	Absorbedor de energía con elemento de amarre en Y integrado. Longitud total: 1,75 m. EN 355	70,67
21027006	27021009100	91	Absorbedor de energía 91 con elemento de amarre doble conforme a la EN 355:2002. Diseñado para realizar trabajos de auto aseguramiento de progresión en estructuras. La altura mínima requerida es a partir de 3,10m. Longitud del equipo: 90 cm	107,34
21027011	27021009000	90	Absorbedor de energía 90 con elemento de amarre simple conforme a la EN 355:2002. Diseñado para realizar trabajos de auto aseguramiento de progresión en estructuras. La altura mínima requerida es a partir de 3,10m. Longitud del equipo: 90 cm	66,77

Equipo anticaídas



Los dispositivos anticaídas Tractel® blocfor™ combinan seguridad y durabilidad en un diseño ergonómico y ligero que permite una mayor libertad de movimientos en altura. Nuestra gama completa puede utilizarse en todas las configuraciones, vertical y horizontal, y es capaz de soportar hasta 150 kg del usuario con sus herramientas. El anticaídas blocfor™ integra funciones de seguridad avanzadas. Se bloquea automáticamente si se produce una caída, reduciendo la altura de caída total, e incluye un indicador de caída integrado. Además, la tecnología Energy System Dissipater (ESD) permite al dispositivo asegurar que el usuario no se someterá a un impacto mayor de 600 daN aunque la caída se produzca mientras el cable esté totalmente desenrollado.



Ref.	Código	Descripción	Modelo	€/ u.
1009311	70592	BLOCFOR™ 1.8B DUO ESD - 150KG	Blocfor 1.8A ESD	156,00
1009312	72462	BLOCFOR™ 20 EVO ESD 150KG	Blocfor 1.8B ESD	182,00
1009313	70572	Blocfor 10 esd cable galva m47-m10 150kg	Blocfor 10 AES	440,00
1009305	70662	Blocfor 6 esd cinta m10 m47 150 kg	Blocfor® 6 ESD	350,00

Equipo anticaídas



Ref.	Código	Modelo	Descripción	€ / u.
1002301	2707002200	Disp. retráctil Mod. 2'5	Retractable dispositivo anticaídas, 2,5 m longitud máxima. Con absorbedor de energía. Equipado con 2 conectores Climax mod. 30. El producto puede ser reparado. Peso: 1,2 kg	87,26
1002266	2707002100	Disp. retráctil Mod. 6	Dispositivo anticaídas en cinta de 25 mm. Longitud 6 metros. Equipado con mosquetón de cierre de rosca y de un mosquetón. Peso: 1,6 kg	364,19
1002267	2707003110	Disp. retráctil Mod. 10 M	Dispositivo anticaídas en cable de acero galvanizado de 4 mm de diámetro. Retráctil de cable. Van equipados con un mosquetón de cierre de rosca y un mosquetón giratorio automático.	399,94
1002268	2707003115	Disp. retráctil Mod. 15 M	Dispositivo anticaídas en cable de acero galvanizado de 4 mm de diámetro. Retráctil de cable. Van equipados con un mosquetón de cierre de rosca y un mosquetón giratorio automático.	546,83
1002269	2707003120	Disp. retráctil Mod. 20 M	Dispositivo anticaídas en cable de acero galvanizado de 4 mm de diámetro. Retráctil de cable. Van equipados con un mosquetón de cierre de rosca y un mosquetón giratorio automático.	663,12
2402386	2707003130	Dispositivo retráctil anticaídas 30 m		939,58

Anticaídas retráctil MINIBLOK



Anticaídas retráctil ligero con cinta de 2m de longitud. Este dispositivo destaca por su sencillez en el uso, evitando la necesidad de conocimientos específicos. Dispone de frenado mecánico, consiguiendo un frenado rápido y seguro. En caso de caída, el dispositivo reduce la fuerza impacto por debajo de 6kN.

Dispositivo certificado para trabajos horizontales contra el riesgo de arista viva conforme a RFU/VG 11.060 (máx. 100Kg) y trabajos en factor 2. Dispone de anilla giratoria superior para evitar enredos y mosquetón automático de 21,5mm de apertura.

De funcionamiento sencillo, el dispositivo provee al usuario los metros necesarios para su trabajo estando siempre en tensión, evitando cualquier caída. Están equipados con chip Irucheck NFC, para una eficaz gestión e inspección del equipo.



Ref.	Código	Modelo	Longitud m	€ / u.
2402387	100307700035	MINIBLOK SE-C	2	172,60
2402388	100307700027	MINIBLOK SE-H	2	178,20

Anticaídas retráctil TIGER 2,5M



Anticaídas retráctil con cinta de 2,5m de longitud. Este dispositivo destaca por su sencillez en el uso, evitando la necesidad de conocimientos específicos. Dispone de frenado mecánico, consiguiendo un frenado rápido y seguro. En caso de caída, el dispositivo reduce la fuerza impacto por debajo de 6kN.

Dispositivo certificado para uso vertical. Dispone de gancho inferior giratorio para evitar enredos.

De funcionamiento sencillo, el dispositivo provee al usuario los metros necesarios para su trabajo estando siempre en tensión, evitando cualquier caída. Están equipados con chip Irucheck NFC, para una eficaz gestión e inspección del equipo.



Ref.	Código	Longitud m	€ / u.
2402389	100307700028	2,5	84,20

Anticaídas retráctil KARBOR



Anticaídas retráctil ligero con cinta de 3,5m de longitud. Este dispositivo destaca por su sencillez en el uso, evitando la necesidad de conocimientos específicos. Dispone de frenado mecánico, consiguiendo un frenado rápido y seguro. En caso de caída, el dispositivo reduce la fuerza impacto por debajo de 6kN.

Dispositivo certificado para uso vertical con capacidad para 140Kg. Dispone de anilla giratoria superior para evitar enredos y gancho de 20mm de apertura.

De funcionamiento sencillo, el dispositivo provee al usuario los metros necesarios para su trabajo estando siempre en tensión, evitando cualquier caída. Están equipados con chip Irucheck NFC, para una eficaz gestión e inspección del equipo.



Ref.	Código	Longitud m	€ / u.
2402390	100307700088	3.5	178,80
2402391	100307700068	6	240,00

Anticaídas retráctil KARBOR USO HORIZONTAL SE



Anticaídas retráctil ligero con cinta de 3,5m de longitud. Este dispositivo destaca por su sencillez en el uso, evitando la necesidad de conocimientos específicos. Dispone de frenado mecánico, consiguiendo un frenado rápido y seguro. En caso de caída, el dispositivo reduce la fuerza impacto por debajo de 6kN. Capacidad de uso vertical 140Kg.

Dispositivo certificado para trabajos horizontales contra el riesgo de arista viva conforme a RFU/VG 11.060 (máx. 100Kg) y trabajos en factor 2. Dispone de anilla giratoria superior para evitar enredos y gancho de 20mm de apertura.

De funcionamiento sencillo, el dispositivo provee al usuario los metros necesarios para su trabajo estando siempre en tensión, evitando cualquier caída. Están equipados con chip Irucheck NFC, para una eficaz gestión e inspección del equipo.



Ref.	Código	Longitud m	€ / u.
2402392	100307700084	3.5	217,10
2402393	100307700069	6	263,50

Anticaídas retráctil SEKURBLOK



Anticaídas retráctil con cable de 10m de longitud. Este dispositivo destaca por su sencillez en el uso, evitando la necesidad de conocimientos específicos. Dispone de frenado mecánico, consiguiendo un frenado rápido y seguro. En caso de caída, el dispositivo reduce la fuerza impacto por debajo de 6kN.

Dispositivo con certificación para uso vertical con capacidad para 140Kg. Dispone de anilla giratoria superior para evitar enredos y gancho giratorio de 20mm de apertura.

De funcionamiento sencillo, el dispositivo provee al usuario los metros necesarios para su trabajo estando siempre en tensión, evitando cualquier caída. Están equipados con chip Irucheck NFC, para una eficaz gestión e inspección del equipo.



Ref.	Código	Longitud m	€ / u.
2402394	100307700014	7.5	370,10
2402395	100307700015	10	395,90
2402396	100307700033	15	435,50
2402397	100307700016	20	481,50

Mosquetón N° 981



Mosqueton de acero simétrico Screw-Lock, cierre rosca, con abertura de 18mm. La gama Steelsafe dispone de un tratamiento especial a la corrosión y resultado de 120 horas de exposición al spray salino, frente a las 72 horas requeridas por norma.

Disponible opcionalmente con número de serie individual.



Ref.	Código	€ / u.
2402398	102300900002	4,70

Mosquetón N° 39



Gancho de acero Due-Lock, cierre automático doble acción, con abertura de 50mm. La gama Steelsafe dispone de un tratamiento especial a la corrosión y resultado de 120 horas de exposición al spray salino, frente a las 72 horas requeridas por norma.



Ref.	Código	€ / u.
2402399	102300900003	10,70

Dispositivo de anclaje X2



Línea de vida temporal horizontal de cinta certificada para dos usuarios simultáneos con riesgo de caída. Esta es nuestra línea de vida más versátil, estando certificada para ser instalada de 4 modos diferentes:

- Ambos extremos de la línea conectados a dos puntos de anclaje fijos (p.e. anillas de anclaje)
- Ambos extremos de la línea conectados a dos puntos de anclaje temporales (p.e. cintas de anclaje)
- Cada extremo de la propia línea abrazando un pilar (Alondrado)
- Abrazando la línea alrededor de una estructura de gran envergadura

Esta línea está equipada con un ratchet que permite regular la longitud de 5m a 20m y tensor la cinta fácilmente.



Ref.	Código	€ / u.
2402400	102101700001	69,50

Dispositivo de anclaje KIT TRIPODE IRUDEK TRIP10/20M



KIT de anclajes que incluye:

- 1 x TRIP1
- 1 x TRN1
- 1 x SEKURBLOK

Ref.	Código	€ / u.
2402401	100307700013	1.962,80



Dispositivo de anclaje CTA EXPRESS



Las CTA Express son cintas de anclaje robustas y ligeras. Este tipo de anclajes son los más populares gracias a su versatilidad.

Ref.	Código	Color	Longitud cm	€ / u.
2402402	100201700002	Amarillo	60	5,10
2402403	100201700011	Azul royal	90	6,60
2402404	100201700003	Verde	120	8,60
2402405	100201700005	Rojo	150	9,50
2402406	100201700012	Negro	200	11,90



Dispositivo de anclaje anilla IRUDEK PRO2



La anilla de anclaje fija PRO2, es nuestra anilla más popular, por su capacidad y sencillez en la instalación. Permite conseguir un punto de anclaje para 2 usuarios de forma fija de una manera sencilla.

Ref.	Código	€ / u.
2402407	100200500003	21,80



Cinturón de sujeción



Ref.	Código	Modelo	Descripción	€ / u.
1009002	2651025200	25-CN	Banda lumbar rellena de espuma de polietileno. Cinta de poliéster de 45 mm. Anillas D de acero cincado. Hebillas reguladoras de acero cincado. Elemento de amarre de sujeción incorporado de 12 mm de diámetro provisto de regulador de longitud.	46,27

Cuerda



Ref.	Código	Modelo	Descripción	€ / u.
1009104	2702002102	CU.29/1	Cuerda fabricada en poliamida con tres testigos. 14 mm. Total longitud:1,5 mts. EN 354	12,80
1009106	2702101100	CU.29/1 Semi	Cuerda semiestática fabricada en poliamida con tres testigos. 14 mm. Total longitud: 1,5 mts. EN 354	15,10
1009107	2702002101	CU.30/1	Cuerda 14 mm diámetro. Longitud ajustable entre 0,85 mts. a 1,35 mts. EN 354	19,23
1009108	2702101101	CU.30/1 Semi	Cuerda semiestática 14 mm diámetro. Longitud ajustable entre 0,85 mts. a 1,35 mts. EN 354	20,46
1009109	2702008111	CU. 31/1	Cuerda 14 mm diámetro. Longitud ajustable entre 0,85 mts. y 1,35 mts. EN 358	62,74
1009110	2702008100	CU. 31/1 Semi	Cuerda semiestática 14 mm diámetro. Longitud ajustable entre 0,85 mts. y 1,35 mts. EN 358	102,34
1009111	2702008103	CU. 31/1 Tree 4 mt	Revestimiento de poliamida. Longitud ajustable entre 0,85 mts. y 1,35 mts. EN 358	281,41
1009112	2702008200	39	Cuerda 14 mm diámetro. Conectores: 1 mod. 31 y 1 mod. 30. EN 354, EN 358	33,15

CUERDA NEXION 150



Cuerda de conexión semiestática de 12mm de diámetro y 1,5m de largo. Pueden realizarse conexiones sobre ellas o utilizarlas como elementos de sujeción. Al no incluir absorbedor de energía, no pueden ser utilizadas como sistema anticaídas. Todas nuestras cuerdas de conexión incluyen guardacabos plásticos para evitar rozaduras de la cuerda con el conector.



Ref.	Código	Descripción	€/ u.
2402408	101002100001	Cuerda de conexión semiestática de 12mm de diámetro y 1,5m de largo. Pueden realizarse conexiones sobre ellas o utilizarlas como elementos de sujeción. Al no incluir absorbedor de energía, no pueden ser utilizadas como sistema anticaídas. Todas nuestras cuerdas de conexión incluyen guardacabos plásticos para evitar rozaduras de la cuerda con el conector.	10,90

CUERDA NEXION 150-H



Cuerda de conexión semiestática de 12mm de diámetro y 1,5m de largo. Pueden realizarse conexiones sobre ellas o utilizarlas como elementos de sujeción. Al no incluir absorbedor de energía, no pueden ser utilizadas como sistema anticaídas. Todas nuestras cuerdas de conexión incluyen guardacabos plásticos para evitar rozaduras de la cuerda con el conector.



Ref.	Código	Descripción	€/ u.
2402409	101002100023	Cuerda de conexión semiestática de 12mm de diámetro y 1,5m de largo. Pueden realizarse conexiones sobre ellas o utilizarlas como elementos de sujeción. Al no incluir absorbedor de energía, no pueden ser utilizadas como sistema anticaídas. Todas nuestras cuerdas de conexión incluyen guardacabos plásticos para evitar rozaduras de la cuerda con el conector.	30,60

CUERDA 239



Cuerda de posicionamiento sencillo, con hebilla de ajuste manual. Su diámetro es de 12mm.



Ref.	Código	Descripción	€/ u.
2402410	101002100002	Cuerda de posicionamiento sencillo, con hebilla de ajuste manual. Su diámetro es de 12mm.	18,40

CUERDA 237/2



Cuerda de posicionamiento con mecanismo de bloqueo ajustable de aluminio. Dicho mecanismo es muy sencillo y cómodo de accionar.



Ref.	Código	Descripción	Longitud	€/ u.
2402411	101007100006	Cuerda de posicionamiento con mecanismo de bloqueo ajustable de aluminio. Dicho mecanismo es muy sencillo y cómodo de accionar.	2M	74,30

07

Elemento de Amarre



El conjunto mod. 39 SEMI constituye un componente indispensable para formar un sistema anticaídas seguro. Está concebido para unirse, mediante el a un arnés anticaídas y formar junto a un absorbedor de energía un sistema anticaídas totalmente seguro para trabajar



CONJUNTO 39 Semi



CONJUNTO 40 SEMI

Ref.	Código	Descripción	Modelo	€/ u.
2402412	2702101200		CONJUNTO 39 Semi	37,30
2402413	2702101300		CONJUNTO 40 SEMI	36,91
1009113	2702008300	Cuerda fabricada en poliamida. 14 mm diámetro. Conectores: 1 mod. 31 y 1 mod. 32. EN 354, EN358	CONJUNTO 40	34,77

Dispositivo anticaídas deslizante



El dispositivo anticaídas deslizante es un elemento que dispone de una función de bloqueo automático y de un mecanismo de guía. Dicho dispositivo anticaídas se desplaza a lo largo de su línea de anclaje, acompañando al usuario sin requerir su intervención manual, durante los cambios de posición hacia arriba o hacia abajo y se bloquea automáticamente sobre la línea de anclaje cuando se produce una caída dando lugar a la correspondiente disipación de energía. Esta disipación se produce por la acción conjunta del dispositivo anticaídas deslizante y la línea de anclaje.



A.D.A.14



OTTO

Ref.	Código	Descripción	Modelo	€/ u.
1009105	2702003100	Anticaídas deslizante automático, para cuerda de poliamida de 14 mm diámetro	A.D.A.14	62,86
1009114	2707001200	Dispositivo anticaídas, para cuerda semiestática de 11 mm	OTTO	65,78

Equipo anticaídas



Anclaje transportable para espacios confinados Davitrac™. El Davitrac es una solución completa para elevación vertical segura de personas y materiales en situación de espacios confinados. Es una solución móvil y eficiente para situaciones de rescate.

Ref.	Código	Descripción	€/ u.
2402414	286819	DAVITRAC™ Pescante espacios confinados	6.289,00



Línea de vida permanente. Travspring



La línea de vida travspring™ es una línea de vida de proximidad en la cual el usuario pasa, manualmente y sin tener que desconectarse, los puntos de anclaje intermedios de soporte de cable. Los soportes intermedios deben instalarse a una distancia máxima de 15 metros (según altura de caída libre). La línea de vida travspring™ está estudiada para 5 usuarios. Todos los elementos de la línea son de acero inoxidable, con un cable de 8 mm galvanizado o de acero inoxidable. La línea travspring™ puede instalarse en la pared, en el suelo o en un poste, y el montaje es muy sencillo.



Ref.	Código	Descripción	€/ u.
1002320	66848	Soporte extremo mural travspring acero inox (2 uni. por línea de vida)	58,00
1002321	66698	Soporte extremo poste travspring acero inox (2 uni. por línea de vida)	29,00
1002324	66878	Kit soporte curva travspring	267,00
1002325	66868	Soporte intermedio travspring (máx 1 cada 15m)	59,00
1002273	130995	Placa sandwich poste base 270x270 - altura 250y 500mm	146,00
1002328	66888	Poste 500mm soporte travspring	164,00
1002274	129505	Collarín impermeabilización	35,00



Línea de vida permanente. Stopcable



El uso de una escalera vertical para acceder a un puesto de trabajo en altura puede suponer un elemento de riesgo. El objetivo del sistema anticaídas vertical de cable stopcable™ S es garantizar la seguridad del personal durante todo el ascenso. La línea de vida stopcable™ S es un dispositivo de anclaje móvil que permite a una persona moverse sobre un eje vertical con total seguridad y sin necesidad de desconectarse. Consta de un punto fijo superior y de un anticaídas deslizante individual. La línea de vida vertical stopcable™ S ha sido diseñada, creada y probada para cumplir con los requisitos de la norma EN353-1 y la norma EN 353-2.



Ref.	Código	Descripción	Figura	€/ u.
1002277	17872	Soporte extremo acero galvanizado [2 uni. por línea de vida]	A	67,00
1002278	18132	Abarcón acero inoxidable 27mm [2 por soporte extremo]- stopcable 150 kg		9,00
1002329	261809	Tensor de cable acero inoxidable [1 uni. por línea de vida]- 150 kg	D	148,00
1002330	108857	Guía intermedia stopcable - 1 cada 10m- 150 kg	G	55,00
1002284	18132	Abarcón acero inoxidable 27mm [2 por soporte extremo]-stopcable -150 kg		9,00

Línea de vida temporal



Ref.	Código	Descripción	Modelo	€/ u.
1009401	211309	Línea de vida kit tirsafe (t3 + 20m cable + 2 eslingas) - 3 personas- 150 kg	Tirsafe	1.312,00



Línea de vida temporal



Constituye un sistema de anclaje que permite una mayor autonomía de movimiento sin cambiar el punto de anclaje. Así pues, este dispositivo se convierte en una herramienta ideal e indispensable para la realización de determinados trabajos [tejados, terrazas, puentes grúa, etc...]



Ref.	Código	Descripción	Modelo	€/ u.
1009402	2651259100	Línea de vida Horizontal. Cinta de poliéster de 35 mm de ancho y 20 m de largo máx. Ratchet tipo carraca de acero. Puede ser utilizado por 2 personas. EN 795	LÍNEA DE VIDA HORIZONT 20M	72,54
1119403	2651259200	Línea de vida Horizontal. 35 mm grosor y 20 m longitud máxima. Bolsa PVC incluida. Incluye mosquetones giratorios y 2 anillos de instalación. Puede ser utilizado por 2 personas. EN 795	LÍNEA DE VIDA HORIZONT COMPLET 20M	139,57
2402415	2651259400		LÍNEA DE VIDA HORIZONT 30M	125,79
2402416	2651259300		LÍNEA DE VIDA HORIZONT COMPLET 30M	154,83

Trípode rescate



Dispositivo móvil diseñado para el acceso de personas en espacios conados, pozos, tanques, escotillas y otros trabajos subterráneos para la protección contra caída.

Ref.	Código	Descripción	Modelo	€/ u.
1009405	2704003100	Bolsa de trípode	TRIPODE DE RESCATE EN BOLSA PCX-020	2.250,54



Línea de vida temporal



El kit línea de vida vertical es un equipo de protección individual indicado para trabajos en los que exista un riesgo de caída.

Ref.	Código	Modelo	€ / u.
21027007	2707111710	KIT LINEA DE VIDA VERTICAL	161,57



Ducha y lava-ojos



L-101/M



D-101/M

Ref.	Código	Código	€ / u.
1002288	2388-L101/M	L-101/M	192,00
1002289	2388-D101	D-101	435,20
1002290	2388-D101/M	D-101/M	108,80
1002591	2388-DAI	DAI	908,80



D-101



DAI

Mascarilla autofiltrante para partículas serie 3M™ 8000 clásica moldeada



7000034734



7100003010



7000006980



7100101091



71000057145

Ref.	Código	Descripción	€ / u.
1009900	7000034734	8710 Mascarilla FFP1 NR D S/válvula	1,10
1009901	7100003010	8810 Mascarilla FFP2 NR D S/válvula	1,93
1009902	7000006980	8812 Mascarilla FFP1 NR D C/válvula	2,19
1009903	7100101091	8822 Mascarilla FFP2 NR D C/válvula	2,50
1009906	71000057145	8833 Mascarilla FFP3 NR D C/válvula	4,80

Mascarilla autofiltrante para partículas serie 3M™ 8800 Premium moldeada



7100081543



7100081542

Ref.	Código	Descripción	€ / u.
1009905	7100081543	8825 Mascarilla FFP2 NR D C/válvula	9,35
1009904	7100081542	8835 Mascarilla FFP3 NR D C/válvula	10,78



Mascarilla autofiltrante para partículas 3M™ Aura™ 9300+ Confort Plegada



7000088725



7000088724



7000088723



7000088722

Ref.	Código	Descripción	€/ u.
1010050	7000088725	3M™ AURA™ 9310+ Mascarilla FFP1 NR D S/Válvula	1,19
1010051	7000088724	3M™ AURA™ 9312+ Mascarilla FFP1 NR D C/Válvula	1,58
1010052	7000088723	3M™ AURA™ 9320+ Mascarilla FFP2 NR D S/Válvula	2,38
1010053	7000088722	3M™ AURA™ 9322+ Mascarilla FFP2 NR D C/Válvula	3,17

Mascarilla autofiltrante para partículas serie 3M™ especial



7000034740



7000034739



7000088787



7000034738



7000052909

Ref.	Código	Descripción	€/ u.
1010201	7000034740	FFP1 NR D sin válvula Para vapores orgánicos < VLA	5,28
1010202	7000034739	FFP1 NR D con válvula Para vapores orgánicos < VLA	5,95
1010205	7000088787	FFP2 NR D con válvula Para gases ácidos < VLA y ozono	6,81
1010204	7000034738	FFP2 NR D con válvula Para gases ácidos < VLA	8,22
1010206	7000052909	FFP3 R D con válvula Para gases ácidos < VLA	8,56

Mascarilla autofiltrante para partículas serie 3M™ Aura 9400 + industria alimentaria



Ref.	Código	Descripción	€/ u.
1002291	7000088835	3MTM Aura™ 9422+ mascarilla FFP2 NR D	4,29
1002292	7000088836	3MTM Aura™ 9432+ mascarilla FFP3 NR D	8,87

Máscara sin mantenimiento para gases y vapores 3M™ serie 4000



Máscaras autofiltrantes para gases y vapores 3MTM serie 4000. Filtros frente a gases y vapores y partículas integradas en la máscara. No precisa mantenimiento. Fabricada en material hipoalérgico. Diferentes versiones de protección. EN 405:2001.



Ref.	Código	Descripción	€ / u.	Ref.	Código	Descripción	€ / u.
1010300	7100113098	FFA1P2 R D	29,36	1010302	7100113102	FFABE1P3 R D	39,32
1010301	7100113101	FFA2P3 R D	35,74	1010303	7100113103	FFABEK1P3 R D	45,42

Media máscara para gases y vapores 3M™ serie 6000



Piezas elastoméricas hipoalérgicas. Para acoplar filtros de gases y vapores y/o partículas mediante conexión de bayoneta. Bajo mantenimiento. Compatible con otros equipos de protección. Disponible en tres Talla. EN 140:1998.



Ref.	Código	Descripción	€ / u.
1010600	7000146845	6100 Media Máscara Pequeña	25,38
1010601	7000146847	6200 Media Máscara Mediana	25,38
1010602	7000146849	6300 Media Máscara Grande	25,38

Mascarilla con filtro



Ref.	Código	Descripción	Modelo	€ / u.
1003410	2352757100	Equipado con filtros mod. 757/762 A1	757 A1	32,43
1003411	2352757500	Equipado con filtros mod. 757/762 A1P3	757 A1P3	36,99
1003412	2352757200	Equipado con filtros mod. 757/762 B1E1	757 B1E1	37,76
1003413	2352757700	Equipado con filtros mod. 757/762 A1B1E1K1	757 A1B1E1K1	37,07
1003414	2352757600	Equipado con filtros mod. 757/762 A1B1E1K1P3	757 A1B1E1K1P3	41,50
1003415	2352757400	Equipado con filtros mod. 757/762 K1	757 K1	32,67
1003416	2352757800	Equipado con filtros mod. 757/762 P3	757 P3	34,94
1003417	2352762100	Equipado con filtro mod. 757/762 A1	762 A1	22,67
1003418	2352762200	Equipado con filtro mod. 757/762 B1E1	762 B1E1	23,54
1003419	2352762400	Equipado con filtro mod. 757/762 K1	762 K1	24,96
1003420	2352762800	Equipado con filtro mod. 757/762 P3	762 P3	23,54
1003422	2351755200	Equipada con filtros mod. 755 B1E1	755 B1E1	31,95
1003425	2351755400	Equipada con filtros mod. 755 K1	755 K1	27,73
1003426	2351755800	Equipada con filtros mod. 755 P3	755 P3	28,66
1010851	2351755100	Equipada con filtros mod. 755 A1	755 A1	25,89
1003423	2351755801	Equipada con filtros mod. 755 A1B1E1K1	755 A1B1E1K1	32,43
1003424	2351755802	Equipada con filtros mod. 756 A1B1E1K1P3	756 A1B1E1K1P3	35,66
1003427	2351755102	Equipada con filtros mod. 755 A2	755 A2	28,56
1003428	2351755104	Equipada con filtros mod. 755 A2 P3	755 A2 P3	33,14
1003430	2351756100	Equipada con filtros mod. 755 A1	756 A1	29,62
1003431	2351756500	Equipada con filtros mod. 756 A1P3	756 A1P3	34,21
1003432	2351756200	Equipada con filtros mod. 755 B1E1	756 B1E1	32,98
1003433	2351756700	Equipada con filtros mod. 755 A1B1E1K1	756 A1B1E1K1	33,79
1003434	2351756600	Equipada con filtros mod. 756 A1B1E1K1P3	756 A1B1E1K1P3	38,72
1003435	2351756300	Equipada con filtros mod. 755 K1	756 K1	29,28
1003436	2351756400	Equipada con filtros mod. 755 P3	756 P3	32,05
1003437	2351756102	Equipada con filtros mod. 755 A2	756 A2	32,14
1003438	2351756104	Equipada con filtros mod. 755 A2 P3	756 A2P3	38,40



Máscara completa para gases y vapores 3M™ serie 6000



CE EN 149

Piezas elastoméricas hipoalergénicas. Para acoplar filtros de gases y vapores y/o partículas mediante conexión de bayoneta. Bajo mantenimiento. Ligera. Amplio campo de visión. Pantalla en policarbonato. Disponible kit para montura de gafas. Disponible en tres Talla. EN 136, Clase I.



Ref.	Código	Descripción	€/ u.
1010900	7100015974	6700 Máscara completa pequeña (elastómero)	168,82
1010901	7100015051	6800 Máscara completa mediana (elastómero)	168,82
1010902	7100015052	6900 Máscara completa grande (elastómero)	168,82

Máscara completa para gases y vapores 3M™ serie 6000. Accesorios



Ref.	Código	Descripción	€/ u.
1011001	7100188168	6885 Protector de Pantalla Máscara completa s6000	1,88



Máscara



Ref.	Código	Modelo	Descripción	€/ u.
2402417	2351741100	MASCARA 741	El modelo 741 es una máscara completa de utilización general (CL2) diseñada para proporcionar al usuario un elevado nivel de protección y confort. La conexión del filtro es de tipo estándar EN 148-1 (Rd40) y es compatible con toda la gama de filtros Climax modelo 725 (gas, partículas y combinados). Ideal para trabajar en atmósferas contaminadas cuya proporción de oxígeno contenido en el aire sea superior al 19,5% en volumen.	99,60
2402418	2351742100	MASCARA 742	El modelo 742 es una máscara completa de utilización ligera (CL1) diseñada para proporcionar al usuario un elevado nivel de protección y confort. La conexión del filtro es lateral y de tipo bayoneta lo que permite acoplar las gamas de filtros Climax modelo 757-N y 757, ofreciendo al usuario un amplio abanico de filtros para elegir aquel que se adapte mejor a sus necesidades. La conexión ha sido diseñada para evitar que la unión de los filtros a la máscara se haga de manera incorrecta. Ideal para trabajar en atmósferas contaminadas cuya proporción de oxígeno contenido en el aire sea superior al 19,5% en volumen.	99,60



2351741100



2351742100

Mascarilla con filtro



Ref.	Código	Modelo	Descripción	€/ u.
2402419	2354710100	MASCARILLA AUTOFILTRANTE 710 A1P3 RD	Semi-máscara autoltrante con ltrros mixtos integrados (gases y partículas). Su diseño permite su uso en combinación con otros equipos de protección como pantallas de soldadura, faciales, gafas, etc. Tres modelos disponibles: PCX-710 FFA1P3 R D - PCX-720 FFA2P3 R D - PCX-730 FFABEK1P3 R D	25,65
2402420	2354720100	MASCARILLA AUTOFILTRANTE 720 A2P3 RD	Semi-máscara autoltrante con ltrros mixtos integrados (gases y partículas). Su diseño permite su uso en combinación con otros equipos de protección como pantallas de soldadura, faciales, gafas, etc. Tres modelos disponibles: PCX-710 FFA1P3 R D - PCX-720 FFA2P3 R D - PCX-730 FFABEK1P3 R D	27,94
2402421	2354730100	MASCARILLA AUTOFILTRANTE 730 ABK1P3 RD	Semi-máscara autoltrante con ltrros mixtos integrados (gases y partículas). Su diseño permite su uso en combinación con otros equipos de protección como pantallas de soldadura, faciales, gafas, etc. Tres modelos disponibles: PCX-710 FFA1P3 R D - PCX-720 FFA2P3 R D - PCX-730 FFABEK1P3 R D	34,80



Máscara facial



731-C



731



757-S



762



Ref.	Código	Modelo	Descripción	€ / u.
1010850	2351731100	731-C	Material: Caucho natural. Visor panorámico. Filtro con conexión estándar acorde con EN 148/1. Filtros indicados para esta máscara: Mod. 725	81,60
1003440	2351731200	731	Material: Silicona. Visor panorámico. Filtro con conexión estándar acorde con EN 148/1. Filtros indicados para esta máscara: Mod. 725	88,80
1010852	2352757100	757-S	Cuerpo facial en silicona. Tipo filtros: gases, vapores o partículas. Arnés de sujeción y banda de nuca ajustable. EN 140	32,43
1010853	2352762100	762	Cuerpo facial en silicona. Tipo filtros: gases, vapores o partículas. Arnés de sujeción y banda de nuca ajustable. EN 140	22,67

Filtro de partículas, gases y vapores para medias máscaras y máscaras completas 3M™



Filtros para gases y vapores. Filtros para acoplar a piezas faciales 3M mediante conexión de bayoneta. Pueden acoplarse a media máscara y a máscara completa. Vapores orgánicos de punto de ebullición superior a 65°C. Condiciones especiales de utilización: Clase 1: Con media máscara protege hasta 10xVLA ó 1000 ppm, según el valor menor. Con máscara completa protege hasta 200xVLA ó 1000 ppm, según el valor menor. Clase 2: Con media máscara protege hasta 10xVLA ó 5000 ppm, según el valor menor. Con máscara completa protege hasta 200xVLA ó 5000 ppm, según valor menor. VLA: Valor Límite Ambiental.



7000034750

Ref.	Código	Descripción	€ / u.
1011101	7000034750	6054 Filtro k1	9,26
1011103	7100006000	6057 Filtro abe1	8,34
1011104	7000034747	6059 Filtro abek1	9,67
1011105	7000034746	6075 Filtro a1 y formaldehído	9,03

Filtro de partículas, gases y vapores para máscaras completas 3M™



Ref.	Código	Descripción	€ / u.
1011200	7000021315	6098 Filtro exp3 nr (***)	27,38
1011201	7100104327	6099 Filtro abek2p3r (***)	26,48



7100104327

Filtro de partículas para acoplar a máscara 3M™



(junto a retenedor 501 al usar el filtro de gases y vapores, o con la plataforma 603 si no se usa con filtro de gases y vapores)



7000037675

Ref.	Código	Descripción	€ / u.
1011300	7100066104	603 Soporte Filtros s5900	4,90
1011301	7100066103	501 Retenedor Filtros s5900	2,75
1011302	7000037673	5911 Filtro P1R (necesita retenedor 501)*	1,62
1011303	7000037674	5925 Filtro P2R (necesita retenedor 501)*	4,28
1011304	7000037675	5935 Filtro P3R (necesita retenedor 501)*	5,44

Filtro de partículas, para acoplar directamente a cualquier máscara 3M™ con conexión a bayoneta



7000052348

Ref.	Código	Descripción	€ / u.
1011400	7100015050	2125 Filtro P2R	5,07
1011402	7000052348	2128 Filtro P2R, vapores orgánicos y gases ácidos < vla, ozono	5,95
1011403	7000029735	2138 Filtro P3R, vapores orgánicos y gases ácidos < vla, ozono	7,54
1011404	7000032083	6035 Filtro P3R bayoneta encapsulado	6,88

Abreviaturas

FF	Pieza facial autofiltrante
VLA	Límite de exposición ocupacional (Valor Límite Ambiental)
P1 o FFP1	Filtro de partículas o mascarilla autofiltrante con protección hasta 4 veces el VLA, con mascarilla autofiltrante, media máscara, o máscara completa.
P2 o FFP2	Filtro de partículas o mascarilla autofiltrante con protección hasta 10 veces el VLA, con mascarilla autofiltrante y media máscara, y 16 veces el VLA con máscara completa
P3 o FFP3	Filtro de partículas o mascarilla autofiltrante con protección hasta 50 veces el VLA, con mascarilla autofiltrante y media máscara, y 16 veces el VLA con máscara completa.
c/ válvula	Tiene válvula de exhalación. VLA
s/válvula	Sin válvula de exhalación
Oz	Ofrece protección frente a ozono hasta 10 veces el VLA
FH	Protección frente a ácido fluorhídrico en niveles inferiores al VLA
VO	Protección frente a vapores orgánicos en niveles inferiores al VLA (malos olores)
GA	Protección frente a gases ácidos tales como dióxido de azufre o ácido fluorhídrico en niveles inferiores al VLA
A	Filtro de protección frente a vapores orgánicos con buenas propiedades de detección y punto de ebullición superior a 65° C
B	Filtro de protección frente a gases inorgánicos con buenas propiedades de detección
E	Filtro de protección frente a gases ácidos con buenas propiedades de detección
K	Filtro de protección frente a amoníaco y sus derivados orgánicos con buenas propiedades de detección
AX	Filtro de protección frente a vapores orgánicos con buenas propiedades de detección y punto de ebullición inferior a 65° C
Formaldehído	Protección frente a vapores de formaldehído hasta 10 veces el VLA
{A,B,E,K} 1	Duración hasta 1000 ppm según las condiciones de ensayo previstas en la norma EN 14387 para filtros de gases y vapores
{A,B,E,K} 2	Duración hasta 5000 ppm según las condiciones de ensayo previstas en la norma EN 14387
R501	Retenedor para filtros planos: 5911, 5925 y 5935
R603	Plataforma para filtros 5911, 5925 y 5935
R	Reutilizable. El equipo se puede utilizar después de un turno de trabajo
NR	No Reutilizable. El equipo se debe desechar después de un turno de trabajo
D	Cumple con el ensayo de colmatación (Dolomita)

07





Detector monogas desechable SGT (versiones O2, CO, H2S)

Detector monogas portátil

- Uso: 2 años de autonomía sin necesidad de reemplazar sensor.
- Lectura en tiempo real para detección de uno de los siguientes gases:

- Oxígeno O2
- Monóxido de carbono CO
- Ácido sulfhídrico H2S
- Dióxido de azufre SO2
- Dihidrógeno H2
- Amoníaco NH3

- Pantalla LCD de fácil lectura.
- Menú del dispositivo navegable para visualización de información.
- Incluye software para configuración de los valores del dispositivo y programación de alarmas.
- Aviso de alertas por luz led roja, vibración y sonido.
- Certificado ATEX para trabajos en ambientes explosivos.
- Últimas 30 alarmas descargables.
- Equipo robusto, resistente a filtraciones de polvo y líquidos IP67.
- Color naranja para una rápida detección del dispositivo.



Ref.	Código	€ / u.
2402422	801206900001	180,20

Detector multigas 4 GASES, MGT



Detector multigas portátil.

- Lectura en tiempo real de hasta cuatro gases de forma simultánea:

- Oxígeno O2
- Monóxido de carbón CO
- Sulfuro de hidrógeno H2S
- Explosividad LEL

- Pantalla LCD retroiluminada de fácil lectura y manejo intuitivo.
- Menú del dispositivo navegable para visualización de información.
- Incluye software para configuración de los valores del dispositivo y programar alarmas.
- Aviso de alertas por luz led roja, vibración y sonido.
- Batería recargable de 2000mAh, 24 horas de uso continuo.
- 7000 eventos descargables de la memoria.
- Certificado ATEX para trabajos en ambientes explosivos.
- Equipo robusto, resistente a filtraciones de polvo y líquidos IP67.
- Color naranja para una rápida detección de uso.



Ref.	Código	€ / u.
2402423	801206900004	806,00



Capucha con arnés integrado 3M™ serie S



7000044300



7000044301



S-433



S-533

Ref.	Código	Descripción	Talla	€/ u.
1011750	7000044300	3M™ S-133S capucha corta con arnés integrado	S	56,52
1011751	7000000142	3M™ S-133L capucha corta con arnés integrado	L	56,52
1011752	7000044301	3M™ S-333SG capucha corta con arnés integrado	S	108,16
1011753	7000000144	3M™ S-333LG capucha corta con arnés integrado	L	108,16
1011754	7000044302	3M™ S-433S capucha larga con arnés integrado	S	108,16
1011755	7000000145	3M™ S-433L capucha larga con arnés integrado	L	108,16
1011756	7100011287	3M™ S-533S capucha larga con arnés integrado	S	124,21
1011757	7000000147	3M™ S-533L capucha larga con arnés integrado	L	124,21

Capucha con arnés de gama alta reutilizable 3M™ serie S



Especialmente indicadas para aquellos lugares en los que se requiere cambiar la capucha con frecuencia, sólo hay que cambiar la capucha y se conserva el arnés. Su distribución de aire minimiza el ruido en su interior. Además el arnés incluye un regulador de caudal de aire externo que permite al usuario adaptarlo a su gusto. El arnés tiene ajustes de altura y de diámetro, también se encuentra disponible una banda de confort de reducción de Talla para llegar aún a más usuarios.



7100079870



7100079871



7100079872



7100079874



7000000149



7000000151



7000027992

Ref.	Código	Descripción	€/ u.
1011850	7100079870	3M™ S-655 kit inicial: capucha s-605 con arnés de gama alta, cubierta de ajuste de caudal s955 y un protector de visor.	118,13
1011851	7100079871	3M™ S-657 kit inicial: capucha s-607 con arnés de gama alta, cubierta de ajuste de caudal s955 y un protector de visor.	121,80
1011852	7100079872	3M™ S-757 kit inicial: capucha s-707 con arnés de gama alta, cubierta de ajuste de caudal s955 y un protector de visor.	122,85
1011853	7100079874	S-855 kit inicial: capucha S-855 con arnés de gama alta, cubierta de ajuste de caudal S955 y un protector de visor. con costuras selladas.	232,58
1011854	7000000149	3M™ S-605 recambio de tejido para s655, 10/caja	48,30
1011855	7000000151	3M™ S-607 recambio de tejido para s657, 10/caja	50,37
1011856	7000027992	3M™ S-707 recambio de tejido para s757, 10/caja	53,03

Visor y casco 3M™ serie M



Son cascos y Pantalla faciales ligeros y compactos que ofrecen protección respiratoria, facial, ocular y de cabeza integrada en un solo equipo, con opciones de cobertura de hombros y cuello. Los cascos M-300 y M-400, cuando se utilizan con las unidades de aporte de aire 3M, ofrecen el nivel de protección respiratoria más elevado (consultar según combinaciones).



Ref.	Código	Descripción	€/ u.
1011954	7000104037	M-406 casco con visor de policarbonato y cubre-hombros de alta durabilidad	668,54

Equipo motorizado 3M™ Versaflo™ TR300



La clave para conseguir una protección respiratoria versátil, y fácil de usar en entornos con riesgo de partículas. Compatible con todas las unidades de cabeza. Más pequeño y ligero, caudal de aire controlado, controles fáciles de usar (alarmas audibles y luminosas), baterías inteligentes (de duración media y de larga duración), mantenimiento mínimo y sencillo. Factor de protección TH3 con capuchas de la serie M de 3M [según referencias].



Ref.	Código	Descripción	€/ u.
1012259	7100018809	TR3802E filtro partículas p y vapores orgánicos <vla (olores) Versaflo TR300	54,97
1012260	7100018861	TR3822E filtro partículas p, hf y gases ácidos <vla (olores) Versaflo TR300	53,80
1012250	7100098846	TR302E Versaflo motoventilador, cubierta para filtro y tubo indicador de caudal	559,48
1012251	7100098908	TR315E Versaflo kit inicial motoventilador (TR302E), filtro p (TR371E), prefiltro (TR3600), cinturón estándar (TR325), batería alta capacidad (TR332) y cargador de batería (TR341E) y tubo de respiración bt30	1.237,64
1012253	7100005643	TR332 batería de alta capacidad Versaflo TR300	399,63
1012254	7000103971	TR340 soporte para cargador de batería Versaflo TR300	205,87
1012255	7000103966	TR341E kit de cargador de batería individual Versaflo TR300	278,77
1012256	7100010253	TR344E kit de cargador múltiple para 4 baterías Versaflo TR300	1.123,21
1012257	7000059880	TR3600 prefiltro para Versaflo TR300	23,15

Equipo motorizado 3M™ Versaflo™ TR600



Última generación de equipos motorizados con protección frente a partículas y frente a gases y vapores. Alarma de bajo caudal y baja batería sonora, visual y por vibración. Compatible con todas las unidades de cabeza. Baterías estándar y de alta capacidad. Filtros P, P y vapores orgánicos <VLA (olores), A1P, A2P, ABE1P y ABE2K1HGP.

Ref.	Código	Descripción	€/ u.
1015266	7100053532	TR619e kit inicial TR600	2.070,09
1015267	7000144501	TR630 batería estándar para TR600	434,75
1015268	7000144502	TR632 batería de alta capacidad para TR600	533,45
1015269	7000144503	TR640 soporte de cargador de batería TR600	214,35
1015270	7000144504	TR641E cargador individual de batería TR600	311,72
1015271	7000144505	TR644E cargador múltiple de 4 baterías TR600	1.437,46
1015272	7100021255	TR6600 prefiltro para TR600	2,46
1015273	7100035845	TR662 protector para chispas para TR600	13,11
1015274	7100021251	TR6700FC cubierta para filtros 67... de TR600	18,97
1015275	7100020971	TR6710E filtro de partículas p para TR600	51,46
1015276	7100021247	TR6800FC cubierta para filtros 68... de TR600	18,48
1015277	7100020995	TR6820E filtro de partículas p y vapores orgánicos <vla (olores) para TR600	76,03
1015278	7100021248	TR6100FC cubierta para filtros 61... de TR600	18,41
1015279	7100020996	TR6110E filtro a1p para TR600	99,41
1015280	7100020997	TR6130E filtro abe1p para TR600	120,82
1015281	7100021336	TR6300FC cubierta para filtros 63... de TR600	20,04
1015282	7100020998	TR6310E filtro a2p para TR600	111,11
1015283	7100021252	TR6500FC cubierta para filtros 65... de TR600	18,95
1015284	7100020999	TR6580E filtro abe2k1hgp para TR600	152,05





Accesorios

Tubos de respiración BT

Ref.	Código	Descripción	€ / u.
1012750	7100006955	BT30 tubo de respiración de longitud ajustable	89,85
1012751	7100069524	BT40 tubo de respiración super resistente	157,85
1012752	7000000158	3M™BT-20S tubo de respiración s/m, 1/caja, (735 mm)	72,06
1012753	7000000159	3M™ BT-20I tubo de respiración m/l, 1/caja, (965 mm)	73,02



Conexiones de unidad de cintura

Conector rápido [rosca macho 1/4" BSP], opción de Broomwade, Rectus, CEJN.

Ref.	Código	Descripción	€ / u.
1012801	7000044241	Conector rápido para Unidad de cintura - rectus 25 macho; rosca macho 1 / 4" bsp	26,05



Conexiones para mangueras

Juego de conexiones rápidas [rosca hembra 3/8" BSP], opción Broomwade, Rectus o CEJN. Conector de empalme entre mangueras [3/8"] rosca hembra BSP en ambos lados.

Ref.	Código	Descripción	€ / u.
1012900	7000042673	Juego de conexión rápida - cejn 342, rosca macho y hembra 3 / 8" bsp	502,06



Mangueras de suministro de aire

Cinco opciones: ligera de 5m, ligera en espiral de 7,5 m, estándar de 10 y de 30 m, antiestática y resistente a altas temperaturas de 10 m.

Ref.	Código	Descripción	€ / u.
1013000	7000042676	Manguera suministro aire estándar de 10 m (sin conexiones)	167,12
1013004	7000044242	Manguera suministro aire estándar de 10 m antiestática y de alta temperatura (sin conexiones)	486,04



Unidad de filtración 3M™ Aircare™

Sistema de filtración diseñado para proporcionar aire de calidad respirable. Disponible como unidad de pared o portátil. Disponibles bifurcaciones y trifurcaciones para 2 ó 3 mangueras.

Ref.	Código	Descripción	€ / u.
1013150	7100035217	Unidad de filtración de aire comprimido para pared	969,85
1013151	7100035348	Unidad de filtración de aire comprimido para suelo	987,66



Consumibles

Ref.	Código	Descripción	€ / u.
1013250	7000044288	Kit de recambio de filtros	228,61



07

Regulador de suministro de aire 3M™ Versaflo™ V-500, V-100 Y V-200

3M

CE EN 12941

Aseguran un control individual del caudal del aire. El regulador requiere una presión de trabajo de [3,5-8] bares y es extramadamente silencioso, gracias a un silenciador integrado (<65dBA). El equipo tiene un silbato integrado que actúa como alarma de bajo caudal. Compatible con todas las unidades de cabeza 3M. Además ahora también las versiones con enfriamiento y calentamiento de aire.



Ref.	Código	Descripción	€/ u.
1012450	7100005806	V500E Versaflo regulador de suministro de aire con cinturón	479,24
1012451	7000103980	V100e Versaflo unidad de enfriamiento y regulación de suministro de aire con cinturón	737,10
1012452	7000103979	V200e Versaflo unidad de calentamiento y regulación de suministro de aire con cinturón	1.005,41

Equipo suministro aire 3M™ S200+

3M

CE EN 139:1994

Equipo de suministro de aire para utilizar con piezas faciales. Compatible con piezas faciales 3M (serie 6000, 7000) mediante conexión de bayoneta. Caudal de aire regulable entre 140 y 300 l/min (presión de entrada 3-7 bar), puede utilizarse en modo dual con filtros adicionales. Permite conectar una manguera para pistola de pulverización. Gama de mangueras de 10 y 30 m. Factor de protección nominal 50 (media máscara) y 200 (máscara completa). EN 139:1994.

Ref.	Código	Descripción	€/ u.
1013300	7000144498	S200+ conjunto de suministro de aire S200+	777,10
1013306	7000088345	Válvula de sobreflujo para S200+	59,89
1013307	7100024108	Regulador de caudal de aire para S200+	490,22
1013308	7000144499	Tubo de respiración para S200+	334,65



Dispensador de tapones 3M™ One Touch Pro

3M



Ref.	Código	Descripción	€/ u.
1020801	7000038203	CLASSIC botella dispensador	0,20
1020804	7000038202	EARSOFT yellow neons botella dispensador	0,19
1020807	7000103721	1100 botella dispensador	0,18

Tapón desechable

3M

CE EN 352 CE EN 352-2



Ref.	Código	Descripción	€/ u.
1011500	7100100637	1100 Tapón moldeable desechable sin cordón	0,18
1011501	7100100638	1110 Tapón moldeable desechable con cordón	0,45
1011510	7000038198	CLASSIC (en cajita pillowpack)	0,23
1011511	7100111802	EARSOFT yellow neons (bolsa)	0,17
1011513	7000052710	EARSOFT FX (bolsa)	0,25

Tapón desechable



Tapaoídos 13 E (con cordón)



Tapaoídos 13 E

Ref.	Código	Descripción	Modelo	€/ u.
1002299	2251213200	Tapones auditivos de espuma de PU desechables. Con cordón. SNR 36. EN 352-1	Tapaoídos 13 E (con cordón)	0,46
1002305	2251213100	Tapones auditivos de espuma de PU desechables. SNR 36. EN 352-2	Tapaoídos 13 E	0,21

3M™ E-A-R™ Flexible Fit Tapón



Ref.	Código	€/ u.
21003022	7100212747	0,82
21003023	7100212752	1,22



Tapón con peana de inserción



7000103733 - 7000103732



7000052713 - 7000052714



7000052849

Ref.	Código	Descripción	€/ u.
1020850	7000103733	EXPRESS (pillowpack)	0,86
1020851	7000103732	EXPRESS CON CORDÓN (pillowpack)	1,32
1020852	7000052713	PUSH-INS CON CORDÓN (bolsa)	0,87
1020853	7000052714	PUSH-INS SIN CORDÓN (bolsa)	0,46
1020854	7000052849	NO TOUCH con cordón	0,97

Tapón reutilizable



7100109117



7000103727



7000103745



7000103757



7000038200 - 7000103735



7000103863

Ref.	Código	Descripción	€/ u.
1011504	7100109117	Tapón reutilizable sin cordón con cajita guarda-tapones	2,07
1011520	7000103727	ULTRAFIT (pillowpack) - embalaje pequeño	2,36
1011521	7000103745	ULTRAFIT con cajita guarda-tapones	2,45
1011522	7000103757	ULTRAFIX X con cordón (caja plástico)	2,93
1011523	7000038200	TRACERS (pillowpack)	2,72
1011524	7000103735	TRACER con cajita guarda-tapones	2,95
1011525	7000103863	ULTRAFIT 20 (pillowpack)	2,87



Orejera



Ref.	Código	Descripción	Modelo	€/ u.
1011550	2251010100	El arnés: PBT. Casquetes: ABS. Almohadillas: en contacto de PVC rellenas de espuma poliéster. Almohadillas recambiables. Puede utilizarse en posición de nuca o cabeza.	10	12,78
1011551	2251012100	Protector auditivo plegable. Casquetes: ABS. Almohadillas: PVC antialérgico recambiables.	12	25,25
1011552	2251014100	El arnés consta de banda de PVC y varilla de acero inoxidable. Casquete: polipropileno. Almohadillas: en contacto de PVC rellenas de espuma poliéster. Almohadillas recambiables.	14-P	27,31
2402424	2251017100	Diseñado para proteger de forma óptima al usuario contra la exposición continuada a elevado ruido, reduciendo sus efectos perjudiciales. Acoplable a cascos Climax	CX 17-P 5RS/RG	27,73
2402425	2251017300	Diseñado para proteger de forma óptima al usuario contra la exposición continuada a elevado ruido, reduciendo sus efectos perjudiciales.	CX 17-P TXR	27,73
2402426	2251017400	Diseñado para proteger de forma óptima al usuario contra la exposición continuada a elevado ruido, reduciendo sus efectos perjudiciales. Ideal para trabajos en ambientes de elevado ruido a "jornada completa".	CX 17-P CURRO	27,73
2402427	2251018100	Diseñado para proteger de forma óptima al usuario contra la exposición continuada a elevado ruido, reduciendo sus efectos perjudiciales. Ideal para trabajos en ambientes de elevado ruido a jornada completa.	18-P	27,73
2402428	2251019100	Protector auditivo electrónico diseñado para proteger de forma óptima al usuario contra la exposición continuada a elevado ruido, reduciendo sus efectos perjudiciales.	19-P	25,74
2402429	2251020100		20-P	144,16

Orejera 3M™ Peltor™ X



Nueva gama de orejeras. Mejora el confort y diseño respecto a la gama Optime. Mejores acabados y orejeras más ligeras [X4 pesa tan solo 234 g, la más ligera con este nivel de atenuación]. Electricamente aisladas (versión diadema). Nuevos materiales que permiten similares atenuaciones en menor volumen de orejera y la orejera de máxima atenuación del mercado [X5: 37 dB].

Ref.	Código	Descripción	€/ u.
1015255	7000103987	Orejera diadema 3M Peltor X1	25,99
1015257	7000103989	Orejera diadema 3M Peltor X2	33,34
1015259	7000103991	Orejera diadema 3M Peltor X3	37,29
1015261	7000103993	Orejera diadema 3M Peltor X4	44,07
1015263	7000103995	Orejera diadema 3M Peltor X5	49,95



Orejera 3M™ Peltor™ Lite-Com PMR 446Mhz



Radio de comunicación integrada. 8 canales de radio 446 MHz PMR (libre en Europa). Transmisión operada por voz (VOX) y PTT 38 sub canales. Grupos simultáneos en el mismo canal (CTCSS tones) Anti VOX (Busy Channel Lock Out). Potencia de salida ajustable; Lo 25 mW / Hi 150 mW. Batería recargable NiMH o 2 x AA pilas estándar. Micrófono de habla con cancelación de ruido. También disponible como receptor de guía (solo escucha).



Ref.	Código	Descripción	€/ u.
1020931	7000108542	Lite-Com, PMR 446, nuca	802,30
1020930	7000108540	Lite-Com, PMR 446, diadema	802,30
1020932	7000108541	Lite-Com, PMR 446, para casco con anclaje P3E	802,30

Alfombra SAFETY-WALK



Zonas húmedas sin soporte. Espesor 6 mm.



Ref.	Código	Descripción	€/ u.
1014100	7100116736	Antideslizantes y antifatiga ,alfombra safety-walk 3200	831,23
1014101	7100116716	Antideslizantes y antifatiga ,alfombra safety-walk 3200	831,23
1014153	7100116734	Antideslizantes y antifatiga ,alfombra safety-walk antifatiga. 5100 antifatiga safe-tigue	569,64
1014154	7100116733	Antideslizantes y antifatiga ,alfombra safety-walk antifatiga. 5100 antifatiga safe-tigue	1.145,28
1014202	7100116707	Antideslizantes y antifatiga ,alfombra safety-walk antifatiga. 3270e antifatiga	935,55

Antideslizante SAFETY-WALK. Alta agresividad - soporte flexible



Ref.	Código	Descripción	€/ u.
1013904	7000042869	Antideslizantes y antifatiga ,Antideslizante safety-walk. alta agresividad - soporte flexible	47,46
1013905	7000002135	Antideslizantes y antifatiga ,Antideslizante safety-walk. alta agresividad - soporte flexible	80,34
1013951	7100158969	Antideslizantes y antifatiga ,Antideslizante safety-walk. alta agresividad - soporte flexible. grano grueso	118,36
1014003	7000126119	Antideslizantes y antifatiga ,Antideslizante safety-walk. media agresividad - soporte flexible	217,20
1014050	7000126117	Antideslizantes y antifatiga ,Antideslizante safety-walk. conformable - soporte aluminio	208,04
1014051	7000029628	Antideslizantes y antifatiga ,Antideslizante safety-walk. conformable - soporte aluminio	312,01

Cinta antideslizante



Ref.	Código	Código	€/ u.
1002316	60950-00000-00	60950-00000-00	20,18
1002317	60950-00001-00	60950-00001-00	40,37



Absorbente de hidrocarburos



7000052038



7000088321



7000088226

Ref.	Código	Descripción	Absorción embalaje l	Peso embalaje kg	€ / u.
1014250	7000052038	Antideslizantes y absorbentes ,absorbente de hidrocarburos	45	5,5	205,14
1014252	7000088321	Antideslizantes y absorbentes ,absorbente de hidrocarburos	138	7,5	552,18
1014254	7000088226	Antideslizantes y absorbentes ,absorbente de hidrocarburos	260	17	304,00

Absorbente químicos



7000088220



7000051994



7000052037

Ref.	Código	Descripción	Absorción embalaje l	Peso embalaje kg	€ / u.
1014300	7000088220	Antideslizantes y absorbentes ,absorbente químicos	44	6,5	136,80
1014302	7000051994	Antideslizantes y absorbentes ,absorbente químicos	42	5,5	276,16
1014303	7000052037	Antideslizantes y absorbentes ,absorbente químicos	32	3,3	153,69

Absorbente de mantenimiento



7100003876



7000051880



7100134258



7000051876



7000051878

Ref.	Código	Descripción	Absorción embalaje l	Peso embalaje kg	€ / u.
1014350	7100003876	Antideslizantes y absorbentes ,absorbente de mantenimiento	142	6,4	153,69
1014351	7000051880	Antideslizantes y absorbentes ,absorbente de mantenimiento	288	13,6	390,72
1014352	7100134258	Antideslizantes y absorbentes ,absorbente de mantenimiento	120	25	964,70
1014353	7000051876	Antideslizantes y absorbentes ,absorbente de mantenimiento	45	5,5	131,76
1014354	7000051878	Antideslizantes y absorbentes ,absorbente de mantenimiento	32	3,3	89,76

Candado SF40AN



Ref.	Código	Ref.	Código	Color	€ / u.
1308553	44820	044820		Verde	21,60
1308550	44700	044700		Rojo	21,60
1308551	44740	044740		Azul	21,60
1308552	44780	044780		Amarillo	21,60

Candado SF40IN



Ref.	Código	Ref.	Código	Color	€ / u.
1308557	44830	044830		Verde	22,15
1308554	44710	044710		Rojo	22,15
1308555	44750	044750		Azul	22,15
1308556	44790	044790		Amarillo	22,15

Candado SF40PN



Ref.	Código	Ref.	Código	Color	€ / u.
1308561	44840	044840		Verde	21,60
1308558	44720	044720		Rojo	21,60
1308559	44760	044760		Azul	21,60
1308560	44800	044800		Amarillo	21,60

07

Candado SF40PL



Ref.	Código	Código	Color	€/ u.
1308562	44726	044726	Rojo	22,64
1308563	44766	044766	Azul	22,64
1308564	44806	044806	Amarillo	22,64
1308565	44846	044846	Verde	22,64

Candado consignación



Candados amaestrados



Ref.	Código	Anchura cuerpo	Altura total	Grosor cuerpo	Distancia interior arco	Altura interior arco	Diámetro arco	€/ u.
2402430	74/40 rojo MK	40mm	90mm	20mm	19mm	38mm	6,5mm	29,78
2402431	74/40 amarillo MK	40mm	90mm	20mm	19mm	38mm	6,5mm	29,78
2402432	74/40 azul MK	40mm	90mm	20mm	19mm	38mm	6,5mm	29,78
2402433	74/40 verde MK	40mm	90mm	20mm	19mm	38mm	6,5mm	29,78
2402434	74/40 naranja MK	40mm	90mm	20mm	19mm	38mm	6,5mm	29,78
2402435	74/40 lila MK	40mm	90mm	20mm	19mm	38mm	6,5mm	29,78
2402436	74/40 blanco MK	40mm	90mm	20mm	19mm	38mm	6,5mm	29,78
2402437	74/40 negro MK	40mm	90mm	20mm	19mm	38mm	6,5mm	29,78
2402438	74/40 gris MK	40mm	90mm	20mm	19mm	38mm	6,5mm	29,78
2402439	74/40 marrón MK	40mm	90mm	20mm	19mm	38mm	6,5mm	29,78

Candado consignación



Candados amaestrados



Ref.	Código	Anchura cuerpo	Altura total	Grosor cuerpo	Distancia interior arco	Altura interior arco	Diámetro arco	€/ u.
2402440	74/40HB75 rojo MK	40mm	127mm	20mm	19mm	65,5mm	6,5mm	32,79
2402441	74/40HB75 amarillo MK	40mm	127mm	20mm	19mm	65,5mm	6,5mm	32,79
2402442	74/40HB75 Verde MK	40mm	127mm	20mm	19mm	65,5mm	6,5mm	32,79
2402443	74/40HB75 azul MK	40mm	127mm	20mm	19mm	65,5mm	6,5mm	32,79
2402444	74/40HB75 naranja MK	40mm	127mm	20mm	19mm	65,5mm	6,5mm	32,79
2402445	74/40HB75 lila MK	40mm	127mm	20mm	19mm	65,5mm	6,5mm	32,79
2402446	74/40HB75 blanco MK	40mm	127mm	20mm	19mm	65,5mm	6,5mm	32,79
2402447	74/40HB75 negro MK	40mm	127mm	20mm	19mm	65,5mm	6,5mm	32,79
2402448	74/40HB75 gris MK	40mm	127mm	20mm	19mm	65,5mm	6,5mm	32,79
2402449	74/40HB75 marron MK	40mm	127mm	20mm	19mm	65,5mm	6,5mm	32,79



Candado consignación



Candados amaestrados



Ref.	Código	Anchura cuerpo	Altura total	Grosor cuerpo	Distancia interior arco	Altura interior arco	Diámetro arco	€/ u.
2402450	74BS/40 rojo MK	40mm	127mm	20mm	19mm	65,5mm	6,5mm	30,27
2402451	74BS/40 amarillo MK	40mm	127mm	20mm	19mm	65,5mm	6,5mm	30,27
2402452	74BS/40 verde MK	40mm	90mm	20mm	19mm	38mm	4,76mm	30,27
2402453	74BS/40 azul MK	40mm	90mm	20mm	19mm	38mm	4,76mm	30,27
2402454	74BS/40 naranja MK	40mm	90mm	20mm	19mm	38mm	4,76mm	30,27
2402455	74BS/40 lila MK	40mm	90mm	20mm	19mm	38mm	4,76mm	30,27
2402456	74BS/40 blanco MK	40mm	90mm	20mm	19mm	38mm	4,76mm	30,27
2402457	74BS/40 negro MK	40mm	90mm	20mm	19mm	38mm	4,76mm	30,27
2402458	74BS/40 gris MK	40mm	90mm	20mm	19mm	38mm	4,76mm	30,27
2402459	74BS/40 marron MK	40mm	90mm	20mm	19mm	38mm	4,76mm	30,27

Esquinera de goma

NormaLuz

Ref.	Código	Código	Altura mm	Profundidad mm	Anchura mm	€/ u.
1014420	BA41707	APPR03	800	10	100+100	31,50



Espejo de exterior

NormaLuz



Ref.	Código	Características	Peso kg	€/ u.
1008220	BA30560	Luna policarbonato de 1mm, refuerzo aluminio	5,5	132,50
1008221	BA30580	Luna policarbonato de 1mm, refuerzo aluminio	8	290,50
1008222	BA31830	Luna policarbonato de 1mm, refuerzo aluminio	1	62,50

Tope para ruedas de goma con banda reflectante

NormaLuz

Ref.	Código	Altura mm	Profundidad mm	Anchura mm	€/ u.
1014425	BA41519	100	105	490	23,16



Espejo

NormaLuz

Ref.	Código	Material	Ø máx. perforación en madera mm	€/ u.
8001455	BA30960	PVC	50	196,66



Protector cable

NormaLuz

Ref.	Código	Material	Ø máx. perforación en madera mm	€/ u.
8001449	BA20600	PVC	17	73,16
8001450	BA20690	PVC	-	136,66



Esquinera flexible

NormaLuz

Ref.	Código	Material	Color	Medida mm	€/ u.
8001456	BA41008	ESPUMA	Negro/Amarillo	1000x250x15	9,17
2402460	BA41006	ESPUMA	Blanco/Rojo	1000x250x15	5,93



Poste

NormaLuz

Ref.	Código	Material	Ø máx. perforación en madera mm	€/ u.
8001457	BA50090	INOX	7,65	70,00
8001458	BA50190	TEXTIL	7,65	70,00



Estacionador canino

NormaLuz

Ref.	Código	Material	Ø máx. perforación en madera mm	€/ u.
8001461	K10000	METAL	0,43	38,20



Protector plano parking

NormaLuz

Ref.	Código	Material	Color	Medidas	€ / u.
2402461	BA41013	ESPUMA	Blanco/Rojo	400x80x15mm	2,83
2402462	BA41212	ESPUMA	Blanco/Rojo	350x200x40mm	13,10
2402463	BA41214	ESPUMA	Blanco/Rojo	1000x500x40mm	78,17
2402464	BA41215	ESPUMA	Blanco/Rojo	350x50x40mm	30,83
2402465	BA41314	ESPUMA	Amarillo/Negro	1000x500x40mm	83,17
2402466	BA41516	ESPUMA	Amarillo/Negro	400x150x10mm	4,50
2402467	BA41517	ESPUMA	Amarillo/Negro	300x200x10mm	4,50
2402468	BA41518	ESPUMA	Amarillo/Negro	400x320x10mm	8,50



Puntera

NormaLuz

Ref.	Código	Material	€ / u.
8001451	BA22101	PLASTICO	17,20



Resaltos

NormaLuz

Ref.	Código	Material	€ / u.
8001452	BA22135	PLASTICO	33,16



Puntera

NormaLuz

Ref.	Código	Material	€ / u.
8001453	BA22201	PLASTICO	17,20



Resaltos

NormaLuz

Ref.	Código	Material	€ / u.
8001454	BA22235	PLASTICO	33,16



07

Puntera

NormaLuz

Ref.	Código	Material	€/ u.
8001439	BA20301	CAUCHO RECICLADO	18,66
8001440	BA20302	CAUCHO RECICLADO	33,16
8001441	BA20303	CAUCHO RECICLADO	33,16
8001442	BA20304	CAUCHO RECICLADO	49,16
8001443	BA20305	CAUCHO RECICLADO	49,16

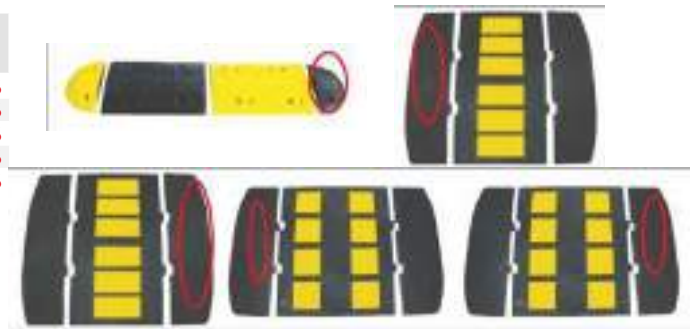

Resaltos

NormaLuz

Ref.	Código	Material	€/ u.
8001444	BA20335	CAUCHO RECICLADO	41,66
8001445	BA20360	CAUCHO RECICLADO	78,32
8001446	BA20390	CAUCHO RECICLADO	110,00



Puntera

NormaLuz

Ref.	Código	Material	€/ u.
8001447	BA20401	CAUCHO RECICLADO	18,66



Resaltos

NormaLuz

Ref.	Código	Material	€/ u.
8001448	BA20435	CAUCHO RECICLADO	41,66



Manta autoadhesiva

NormaLuz

Ref.	Código	Color	Longitud m	Medidas	€/ u.
2402469	BA41510	Negro/Amarillo	5	50cm x 10mm	233,33
2402470	BA41610	Blanco/Rojo	5	50cm x 20mm	330,00
2402471	BA41710	Negro/Amarillo	5	50cm x 20mm	330,00



Cinta de balizamiento

NormaLuz



Ref.	Código	Ancho cm	Grosor mm	Largo m	€/ u.
1008215	RD80212	7,5	0,05	200	15,83
1008216	RD80213	7,5	0,05	200	15,83
1008217	RD80214	7,5	0,05	200	15,83
1008218	RD80215	7,5	0,05	200	15,83
1008219	RD80216	10	0,07	200	29,83

Soporte poste pared

NormaLuz

Ref.	Código	Material	€/ u.
8001459	BA50105	TEXTIL	50,07
8001460	BA50005	INOX	50,07



Conos tráfico

NormaLuz



Ref.	Código	Material	Altura cm	Color	€/ u.
2402472	BA10175	polipropileno rígido	75	Naranja	16,50
2402473	BA10150	polipropileno rígido	50	Naranja	12,16
2402474	BA10230	base PVC	30	Naranja	9,50
2402475	BA12330	base PVC	30	Azul	9,50

Bolardo naranja 8 cm de diámetro

NormaLuz

Ref.	Código	Material	Altura cm	Color	€/ u.
2402476	BA50145	TPE	45	Naranja	18,67



Bolardo flexible naranja 8 cm de diámetro

NormaLuz

Ref.	Código	Material	Altura cm	Color	€ / u.
2402477	BA50175	TPE	75	Naranja	24,33



Hito

NormaLuz

Ref.	Código	Material	Altura cm	Color	€ / u.
2402478	BA51975	PE	75	Verde	63,33



Hito

NormaLuz

Ref.	Código	Material	Altura cm	Color	€ / u.
2402479	BA51875	PE	75	Azul	63,33



Ref.	Código	Material	Altura cm	Color	€ / u.
2402479	BA51875	PE	75	Azul	63,33

Hito

NormaLuz

Ref.	Código	Material	Altura cm	Color	€ / u.
2402480	BA51775	PE	75	Rojo	63,33



Cadenas de plástico

NormaLuz

Ref.	Código	Descripción	Material	Color	€ / u.
2402481	RD80740	Longitu rollo 25m	Plástico	Negro/Amarillo	31,66
2402482	RD80741	Longitu rollo 25m	Plástico	Blanco/Rojo	39,83
2402483	BA501190	Altura poste 900mm	Plástico	Negro/Amarillo	23,33
2402484	BA501090	Altura poste 900mm	Plástico	Blanco/Rojo	23,33



Señal metálica

NormaLuz

Acero inoxidable adhesivo de 0,8 mm.



Ref.	Código	Medidas cm	€/ u.
1008225	RD727002	12x12	3,97
1008226	RD727008	12x12	3,97
1008227	RD727009	12x12	3,97
1008228	RD727010	12x12	3,97
1008229	RD727013	12x12	3,97
1008230	RD727016	12x12	3,97
1008231	RD727017	12x12	3,97
1008232	RD727018	12x12	3,97
1008233	RD727021	12x12	3,97
1008234	RD727022	12x12	3,97
1008235	RD727023	12x12	3,97
1008236	RD727024	12x12	3,97
1008237	RD727025	12x12	3,97
1008238	RD727182	12x12	3,97

Ref.	Código	Medidas cm	€/ u.
1008239	RD797002	7 Ø	2,30
1008240	RD797008	7 Ø	2,30
1008241	RD797009	7 Ø	2,30
1008242	RD797010	7 Ø	2,30
1008243	RD797013	7 Ø	2,30
1008244	RD797016	7 Ø	2,30
1008245	RD797017	7 Ø	2,30
1008246	RD797018	7 Ø	2,30
1008247	RD797021	7 Ø	2,30
1008248	RD797022	7 Ø	2,30
1008249	RD797023	7 Ø	2,30
1008250	RD797024	7 Ø	2,30
1008251	RD797025	7 Ø	2,30

Señal metálica 50 x 50 cm

NormaLuz

Aluminio.

Ref.	Código	€/ u.
1008290	RD32975	39,67



07

Señal de evacuación y extinción

NormaLuz

PVC clase B de 0,7 mm.



Ref.	Código	Longitud mm	€/ u.
1008410	B14105	224x300	3,17
1008416	B14107	224x300	3,17
1008419	B14108	224x300	3,17
1008424	B14109	224x300	3,17
1008425	B14112	224x300	3,17
1008427	B15101	420x300	3,17
1008429	B15100	420x300	3,17
1008430	B14104	224x300	3,17
1008431	B15104	420x300	3,17
1008432	B14111	224x300	3,17
1008434	B14110	224x300	3,17
1008437	B15102	420x300	3,17

Ref.	Código	Longitud mm	€/ u.
1008438	B00134	210x300	3,17
1008443	B00101	210x300	3,17
1008448	B00106	210x300	3,17
1008449	B00107	210x300	3,17
1008450	B00108	210x300	3,17
1008453	B00111	210x300	3,17
1008454	B00112	210x300	3,17
1008455	B00114	210x300	3,17
1008456	B00115	210x300	3,17
1008458	B00117	210x300	3,17
1008460	B00119	210x300	3,17
1008461	B00121	210x300	3,17

Señal de obligación 30 x 40 cm

NormaLuz

PVC clase B de 0,7 mm.

Ref.	Código	€/ u.
1008470	RD21005	3,50



Cartel múltiple 50 x 90 cm

NormaLuz

PVC clase B de 0,7 mm.

Ref.	Código	€/ u.
1008285	RD23000	13,83
1008286	RD23200	13,83



Señal de peligro 21 x 30 cm

NormaLuz

PVC clase B de 0,7 mm.



Ref.	Código	€ / u.	Ref.	Código	€ / u.	Ref.	Código	€ / u.
1008510	RD30000	2,27	1008522	RD30014	2,27	1008534	RD30042	2,27
1008511	RD30001	2,27	1008523	RD30015	2,27	1008535	RD30044	2,27
1008512	RD30002	2,27	1008524	RD30017	2,27	1008536	RD30045	2,27
1008513	RD30003	2,27	1008525	RD30018	2,27	1008537	RD30054	2,27
1008514	RD30004	2,27	1008526	RD30019	2,27	1008539	RD30065	2,27
1008515	RD30005	2,27	1008527	RD30021	2,27	1008540	RD30066	2,27
1008516	RD30006	2,27	1008528	RD30023	2,27	1008541	RD30067	2,27
1008517	RD30007	2,27	1008529	RD30024	2,27	1008543	RD30071	2,27
1008518	RD30009	2,27	1008530	RD30027	2,27	1008544	RD30072	2,27
1008519	RD30010	2,27	1008531	RD30029	2,27	1008545	RD30073	2,27
1008520	RD30011	2,27	1008532	RD30032	2,27	1008546	RD30075	2,27
1008521	RD30012	2,27	1008533	RD30033	2,27	1008547	RD30077	2,27

Señal de prohibido 21 x 30 cm

NormaLuz

PVC clase B de 0,7 mm.



Ref.	Código	€/u.	Ref.	Código	€/u.	Ref.	Código	€/u.
1008610	RD40000	2,27	1008617	RD40019	2,27	1008624	RD40038	2,27
1008611	RD40001	2,27	1008618	RD40020	2,27	1008625	RD40049	2,27
1008612	RD40002	2,27	1008619	RD40022	2,27	1008626	RD40054	2,27
1008613	RD40005	2,27	1008620	RD40023	2,27	1008627	RD40057	2,27
1008614	RD40006	2,27	1008621	RD40025	2,27	1008628	RD40059	2,27
1008615	RD40017	2,27	1008622	RD40029	2,27	1008629	RD40060	2,27
1008616	RD40018	2,27	1008623	RD40030	2,27			

Caballete rectangular

NormaLuz

Metálico.

Ref.	Código	Medidas cm	€/u.
1008295	V16000	130 x 60	33,15



Señal en bolsa 70 x 70 cm

NormaLuz

Tejido textil poroso, transpirable.



Ref.	Código	€/ u.	Ref.	Código	€/ u.	Ref.	Código	€/ u.
1008660	V11100	3,17	1008673	V11113	3,17	1008686	V11128	3,17
1008661	V11101	3,17	1008674	V11115	3,17	1008687	V11130	3,17
1008662	V11102	3,17	1008675	V11116	3,17	1008688	V11131	3,17
1008663	V11103	3,17	1008676	V11117	3,17	1008689	V11132	3,17
1008664	V11104	3,17	1008677	V11118	3,17	1008690	V11133	3,17
1008665	V11105	3,17	1008678	V11119	3,17	1008691	V11134	3,17
1008666	V11106	3,17	1008679	V11120	3,17	1008692	V11135	3,17
1008667	V11107	3,17	1008680	V11121	3,17	1008693	V11136	3,17
1008668	V11108	3,17	1008681	V11122	3,17	1008694	V11140	3,17
1008669	V11109	3,17	1008682	V11123	3,17	1008695	V11141	3,17
1008670	V11110	3,17	1008683	V11124	3,17	1008696	V11160	3,17
1008671	V11111	3,17	1008684	V11125	3,17	1008697	V11161	3,17
1008672	V11112	3,17	1008685	V11126	3,17	1008698	V11165	3,17

Señal metálica

NormaLuz

Acero galvanizado.



Ref.	Código	Medidas cm	€ / u.	Ref.	Código	Medidas cm	€ / u.
1008710	V11000	70	21,50	1008730	V10021	50	21,50
1008711	V11001	70	21,50	1008731	V10022	50	21,50
1008712	V11002	70	21,50	1008732	V10023	50	21,50
1008713	V11003	70	21,50	1008733	V10024	50	21,50
1008714	V11004	70	21,50	1008734	V10025	50	21,50
1008715	V11005	70	21,50	1008735	V10026	50	21,50
1008716	V11006	70	21,50	1008736	V10028	50	21,50
1008717	V11007	70	21,50	1008737	V10030	50	21,50
1008718	V11008	70	21,50	1008738	V10031	50	21,50
1008719	V11009	70	21,50	1008739	V10032	50	21,50
1008720	V11010	70	21,50	1008740	V10033	50	21,50
1008721	V11011	70	21,50	1008741	V10034	50	21,50
1008722	V11012	70	21,50	1008742	V10035	70	21,50
1008723	V11013	70	21,50	1008743	V10036	50	21,50
1008724	V11015	70	21,50	1008744	V10040	50	21,50
1008725	V11016	50	21,50	1008745	V10041	50	21,50
1008726	V10017	50	21,50	1008746	V10060	50	21,50
1008727	V10018	50	21,50	1008747	V11061	70	21,50
1008728	V10019	50	21,50	1008748	V11065	70	21,50
1008729	V10020	50	21,50				

Adhesivos de productos químicos

NormaLuz



Ref.	Código	Material	€/ u.
8001505	RD44600	PVC	1,33
8001506	RD44603	PVC	1,33
8001507	RD44608	PVC	1,33
8001508	RD44626	PVC	1,33
8001509	RD44650	PVC	1,33

Ref.	Código	Material	€/ u.
8001510	RD44651	PVC	1,33
8001511	RD44654	PVC	1,33
8001512	RD44678	PVC	1,33
8001513	RD44679	PVC	1,33

Señal fotoluminiscente

NormaLuz



Ref.	Código	Material	Ø máx. perforación en madera mm	€/ u.
8001462	B00A101	PVC	0,06	3,16
8001463	B00A106	PVC	0,06	3,16
8001464	B00A107	PVC	0,06	3,16
8001465	B00A108	PVC	0,06	3,16
8001466	B00A111	PVC	0,06	3,16
8001467	B11130	PVC	0,06	3,17
8001468	B11131	PVC	0,06	3,17

Ref.	Código	Material	Ø máx. perforación en madera mm	€/ u.
8001469	B11140	PVC	0,06	3,17
8001470	B11141	PVC	0,06	3,17
8001471	B11150	PVC	0,06	3,17
8001472	B11151	PVC	0,06	3,17
8001473	B12104	PVC	0,06	3,17
8001474	B13106	PVC	0,06	3,17

Señal de productos químicos

NormaLuz



Ref.	Código	Material	Ø máx. perforación en madera mm	€/ u.
8001514	RD47000	PVC	0,06	4,84
8001515	RD47003	PVC	0,06	4,84
8001516	RD47008	PVC	0,06	4,84
8001517	RD47026	PVC	0,06	4,84
8001518	RD47050	PVC	0,06	4,84

Ref.	Código	Material	Ø máx. perforación en madera mm	€/ u.
8001519	RD47051	PVC	0,06	4,84
8001520	RD47054	PVC	0,06	4,84
8001521	RD47078	PVC	0,06	4,84
8001522	RD47079	PVC	0,06	4,84

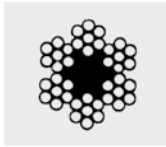

828
Cables



858
Gatos



911
Banco de vestuario



829
Accesorios de cable



861
Mesas elevadoras



913
Carros de taller



837
Cuerdas



862
Apiladores

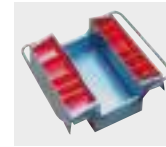

920
Cajas de herramientas



839
Accesorios G-80



864
Carretillas

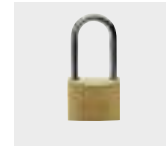

922
Candados



840
Cadenas



863
Transpaletas



930
Maletas porta herramientas



846
Pinzas de elevación



865
Ruedas



932
Cajas de herramientas de plástico



847
Polipastos



903
Grapadoras



939
Cestones



855
Cabrestantes



904
Bancos de trabajo

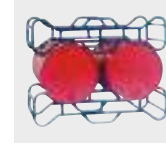

940
Almacenaje de bidones



856
Gatos cremallera



906
Armarios



942
Estanterías



857
Dinamómetros



909
Taquillas



948
Escaleras



858
Eslingas



910
Botiquín



957
Andamios



963

Enrolladores de
manguera



965

Extensibles de
cable



965

Prolongadores



966

Focos LED



968

Lámparas
LED



970

Linternas
frontales



970

Linternas
antideflagantes



971

Pilas



972

Baterías



974

Escobas



974

Contenedores

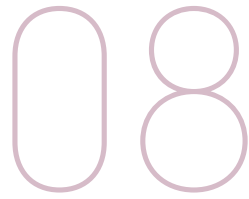

EQUIPAMIENTO PARA TALLER



Cable de acero 6 x 7+1 (180 kg/mm²)

Ref.	Código	Carga de rotura N	Ø Agujero mm	Peso kg/m	€/ m.
700000	Y106071NGD02	239	2	0,0143	0,24
700001	Y106071NGD03	539	3	0,0322	0,39
700002	Y106071NGD04	957	4	0,0572	0,72
700003	Y106071NGD05	1.500	5	0,0894	1,05
700004	Y106071NGD06	2.150	6	0,1290	1,54

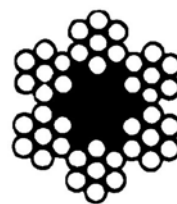
Cable de acero 6 x 19+1 (180 kg/mm²)

Ref.	Código	Ø	Carga de rotura kg	Peso kg/m	€/ m.
700100	Y106191NGD03	3	498	0,0311	0,57
700101	Y106191NGD04	4	885	0,0554	0,88
700102	Y106191NGD05	5	1.380	0,0865	1,17
700103	Y106191NGD06	6	1.990	0,125	1,50
700105	Y106191NGD08	8	3.540	0,221	2,43
700107	Y106191NGD10	10	5.530	0,346	3,60
700109	Y106191NGD12	12	7.970	0,498	5,27
700111	Y106191NGD14	14	10.800	0,678	6,84
700112	Y106191NGD16	16	14.200	0,886	9,11

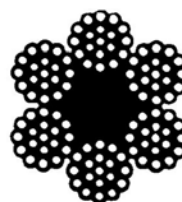
Cable de acero 6 x 37+1 (180 kg/mm²)

Ref.	Código	Ø	Carga de rotura kg	Peso kg/m	€/ m.
700200	Y106371NGD06	6	1.910	0,125	1,94
700202	Y106371NGD08	8	3.400	0,221	2,88
700204	Y106371NGD10	10	5.310	0,346	3,97
700206	Y106371NGD12	12	7.640	0,498	5,47
700208	Y106371NGD14	14	10.400	0,678	6,68
700209	Y106371NGD16	16	13.600	0,886	8,38
700210	Y106371NGD18	18	17.200	1,120	9,60
700211	Y106371NGD20	20	21.200	1,380	13,07
700212	Y106371NGD22	22	25.700	1,670	16,48
700213	Y106371NGD24	24	30.600	1,990	19,72
700214	Y106371NGD26	26	35.900	2,340	24,61
700215	Y106371NGD28	28	41.600	2,710	29,57
700217	Y106371NGD30	32	54.300	3,540	33,93

Cable de acero 17 x 7+1 antigiro (200 kg/mm²)

Ref.	Código	Ø	Carga de rotura kg	Peso kg/m	€/ m.
700302	Y119070NND06	6	2.355	0,14	2,46
700304	Y119070NND08	8	4.189	0,25	3,75
700306	Y119070NND10	10	6.554	0,40	5,22
700308	Y119070NND12	12	9.439	0,56	6,89

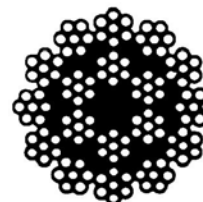

Tensor gancho/gancho DIN 1480

MIKALOR

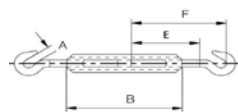

Ref.	Código	Medida	Medida "	Carga trabajo S.W.L. kg	A mm	B mm	€/100
700400	9520650	M 5	3/16"	60	70	35	164,32
700401	9520669	M 6	1/4"	75	110	55	202,80
700402	9520677	M 8	5/16"	135	110	57	275,60
700403	9520685	M 10	3/8"	200	125	68	390,00
700404	9520693	M 11	7/16"	235	125	68	525,20
700405	9520706	M 12	1/2"	265	125	70	556,40
700406	9520714	M 14	9/16"	365	140	75	832,00
700407	9520722	M 16	5/8"	600	170	188	1.144,00

Ref.	Código	Medida	Medida "	Carga trabajo S.W.L. kg	A mm	B mm	€/100
700408	9520730	M 20	3/4"	800	200	105	2.069,60
700409	9520749	M 22	7/8"	1.100	220	118	3.120,00
700410	9520757	M 24	1"	1.335	255	135	3.744,00
700411	9520765	M 27	1 1/16"	1.665	255	135	5.512,00
700412	9520773	M 30	1 1/4"	2.000	255	135	7.072,00
700413	9520781	M 33	1 5/16"	2.235	295	148	9.360,00
700414	9520790	M 36	1 1/2"	2.665	295	160	13.520,00

Tensor gancho/gancho DIN 1480 INOX

MIKALOR

Ref. INOX	Código INOX	Medida	Medida "	A mm	L mm	€/100
700500	9529233	M 5	3/16"	56	70	550,00
700501	9529241	M 6	1/4"	77	110	750,00
700502	9529250	M 8	5/16"	85	110	1.150,00
700503	9529268	M 10	3/8"	106	125	1.700,00
700504	9529276	M 12	1/2"	117	125	2.600,00



Tensor anilla/anilla DIN 1480

MIKALOR

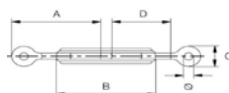

Ref.	Código	Medida	Medida "	Carga trabajo S.W.L. kg	A mm	B mm	€/100
700600	9520853	M 5	3/16"	145	57	70	161,20
700601	9520861	M 6	1/4"	235	80	110	218,40
700602	9520870	M 8	5/16"	320	85	110	280,80
700603	9520888	M 10	3/8"	535	105	125	416,00
700604	9520896	M 11	7/16"	600	108	125	561,60
700605	9520909	M 12	1/2"	665	111	125	582,40
700606	9520917	M 14	9/16"	1.335	124	140	852,80
700607	9520925	M 16	5/8"	1.665	150	170	1.248,00

Ref.	Código	Medida	Medida "	Carga trabajo S.W.L. kg	A mm	B mm	€/100
700608	9520933	M 20	3/4"	2.535	168	200	2.288,00
700609	9520941	M 22	7/8"	2.665	190	220	3.120,00
700610	9520950	M 24	1"	3.665	212	255	4.160,00
700611	9520968	M 27	1 1/16"	4.800	224	255	5.408,00
700612	9520976	M 30	1 1/4"	5.335	224	255	7.488,00
700613	9520984	M 33	1 5/16"	7.335	245	295	9.360,00
700614	9520992	M 36	1 1/2"	8.665	277	295	14.248,00

MIKALOR

Tensor anilla/anilla DIN 1480 INOX

Ref. INOX	Código INOX	Medida	Medida "	Carga trabajo S.W.L. kg	B mm	L mm	€/100
700700	9529284	M 5	3/16"	60	57	70	550,00
700701	9529292	M 6	1/4"	70	80	110	730,00
700702	9529305	M 8	5/16"	140	88	110	1.200,00
700703	9529313	M 10	3/8"	220	105	125	1.750,00
700704	9529321	M 12	1/2"	310	111	125	2.700,00

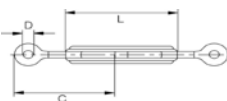

Tensor gancho/anilla DIN 1480

MIKALOR

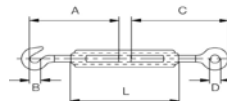

Ref.	Código	Medida	Medida "	Carga trabajo S.W.L. kg	L mm	C mm	€/100
700800	9521100	M 5	3/16"	60	70	57	159,12
700801	9521119	M 6	1/4"	75	110	80	228,80
700802	9521127	M 8	5/16"	135	110	85	286,00
700803	9521135	M 10	3/8"	200	125	105	416,00
700804	9521143	M 11	7/16"	235	125	108	551,20
700805	9521151	M 12	1/2"	265	125	111	603,20
700806	9521160	M 14	9/16"	365	140	124	832,00
700807	9521178	M 16	5/8"	600	170	150	1.248,00

Ref.	Código	Medida	Medida "	Carga trabajo S.W.L. kg	L mm	C mm	€/100
700808	9521186	M 20	3/4"	800	200	168	2.184,00
700809	9521194	M 22	7/8"	1.100	220	190	3.016,00
700810	9521207	M 24	1"	1.335	255	212	4.264,00
700811	9521215	M 27	1 1/16"	1.665	255	224	5.408,00
700812	9521223	M 30	1 1/4"	2.000	255	224	6.864,00
700813	9521231	M 33	1 5/16"	2.335	295	245	8.840,00
700814	9521240	M 36	1 1/2"	2.665	295	277	15.080,00

Tensor gancho/anilla DIN 1480 INOX

MIKALOR

Ref. INOX	Código INOX	Medida	Medida "	Carga trabajo S.W.L. kg	L mm	C mm	€/100
700900	9525603	M 5	3/16"	60	70	57	545,00
700901	9525718	M 6	1/4"	75	110	80	750,00
700902	9525873	M 8	5/16"	135	110	88	1.125,00
700903	9525881	M 10	3/8"	200	125	105	1.650,00
700904	9525890	M 12	1/2"	235	125	111	2.515,00
700905	9525929	M 16	5/8"	265	170	150	5.500,00

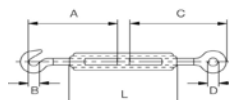

Tensor horquilla/horquilla DIN 1480

MIKALOR

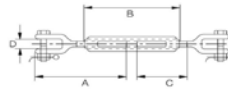

Ref.	Código	Medida	Medida"	Carga trabajo S.W.L. kg	B mm	A mm	€/100
701000	9521303	M 6	3/16"	235	101	110	634,40
701001	9521311	M 8	5/16"	320	110	110	728,00
701002	9521320	M 10	3/8"	535	125	110	1.040,00
701003	9521338	M 12	1/2"	665	138	125	1.560,00
701004	9521346	M 14	9/16"	1.035	145	135	2.496,00
701005	9521354	M 16	5/8"	1.665	175	170	2.808,00
701006	9521362	M 20	3/4"	2.535	213	200	4.472,00

Ref.	Código	Medida	Medida"	Carga trabajo S.W.L. kg	B mm	A mm	€/100
701007	9521370	M 22	7/8"	3.000	240	220	6.032,00
701008	9521389	M 24	1"	3.665	275	255	9.360,00
701009	9521397	M 27	1 1/16"	5.000	275	255	12.480,00
701010	9521400	M 30	1 1/4"	5.335	300	255	13.520,00
701011	9521418	M 33	1 5/16"	6.165	311	295	21.840,00
701012	9521426	M 36	1 1/2"	250	390	295	26.000,00

Tensor horquilla/horquilla DIN 1480 INOX

MIKALOR

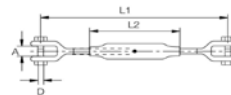

Ref. INOX	Código INOX	Medida	Medida"	Carga trabajo S.W.L. kg	B mm	A mm	B mm	€/100
701100	9526809	M 6	1/4"	300	101	110	101	717,60
701101	9526817	M 8	5/16"	600	110	110	110	884,00
701102	9526825	M 10	3/8"	900	125	125	125	1.248,00
701103	9526833	M 12	1/2"	1.200	138	125	138	1.768,00
701104	9526850	M 16	5/8"	2.000	175	170	175	3.016,00

Ref. INOX	Código INOX	Medida	Medida"	Carga trabajo S.W.L. kg	B mm	A mm	B mm	€/100
701105	9526868	M 20	3/4"	3.000	213	200	213	4.472,00
701106	9526884	M 24	1"	255	275	255	275	9.152,00
701107	9526905	M 30	1 1/4"	255	300	255	300	12.480,00
701108	9526921	M 36	1 1/2"	295	385	295	385	27.040,00

Tensor para cable

MIKALOR

Ref.	Código	Medida	A mm	B mm	€/100
701200	19521731	80x26	26	80	124,80
701201	19521740	92x26	26	90	145,60
701202	9521725	104x26	26	104	166,40

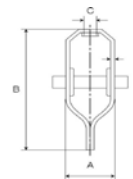

Sujetacables DIN 741

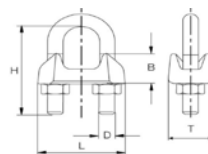

Ref.	Código	Ø Cable mm	D	H mm	L mm	B mm	T mm	€/100
701300	9520010	2-3	M 4	16	21	10	10	28,08
701301	9520028	4-5	M 5	19	23	10	11	31,20
701302	9520036	6-6,5	M 5	23	26	11	12	38,48
701303	9520044	8	M 6	28	30	15	14	46,80
701304	9520052	10	M 8	34	34	17	18	78,00
701305	9520060	11	M 8	36	36	18	19	82,16
701306	9520079	13	M 10	45	42	21	23	145,60
701307	9520087	14	M 10	47	44	22	23	150,80
701308	9520095	16	M 12	51	50	26	26	223,60

Ref.	Código	Ø Cable mm	D	H mm	L mm	B mm	T mm	€/100
701309	9520108	19	M 12	63	54	30	29	291,20
701310	9520124	22	M 14	71	61	34	33	431,60
701311	9525697	26	M 14	81	65	37	35	499,20
701312	9525700	30	M 16	94	74	43	37	764,40
701313	9525865	34	M 16	104	80	50	42	988,00
701314	9520167	40	M 16	124	88	55	45	1.248,00
701315	9520175	45	M 18	148	112	65	49	2.600,00
701316	9520183	50	M 20	152	121	67	51	3.016,00

Sujetacables DIN 741 INOX

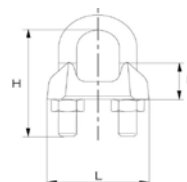

Ref. INOX	Código INOX	Ø Cable mm	D	H mm	L mm	B mm	€/100
701400	9524150	3-4	M 4	18,5	21	10	200,00
701401	9524168	5	M 5	19	23	10	260,00
701402	9524176	6	M 5	23	26	11	270,00
701403	9524184	8	M 6	28	30	15	340,00
701404	9524192	10	M 8	34	34	17	420,00
701405	9524205	12	M 8	36	36	18	500,00

Ref. INOX	Código INOX	Ø Cable mm	D	H mm	L mm	B mm	€/100
701406	9524213	14	M 10	47	44	22	900,00
701407	9524221	16	M 12	51	50	26	1.300,00
701408	9524248	18	M 12	63	54	30	1.400,00
701409	9524256	22	M 14	71	61	34	2.200,00
701410	9524264	25	M 14	81	65	37	2.700,00
701411	9524272	28	M 16	94	74	43	3.900,00

Sujetacables forma española

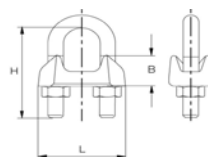

Ref.	Código	Ø Cable mm	H mm	L mm	B mm	€/100
701500	9526008	2-3	20	23	11	40,56
701501	9526016	4-5	24	26	13	46,80
701502	9526024	6-6,5	30	32	15	72,80
701503	9526032	8	30	35	16	79,04
701504	9526040	10	41	40,5	21,6	124,80
701505	9526059	11	41	43	22	130,00

Ref.	Código	Ø Cable mm	H mm	L mm	B mm	€/100
701506	9526067	13	50	49	23,3	197,60
701507	9526075	14	55	52,5	27	249,60
701508	9526083	16	58	57,5	28	286,00
701509	9526091	18	63	61	34	416,00
701510	9526104	20	77	71	38	665,60
701511	9526112	22	85	77,5	43	884,00

Sujetacables plano simple

MIKALOR

Ref.	Código	Ø Cable mm	Medida	L mm	€/100
701600	9520255	2	M4	18,5	35,36
701601	9520263	3	M4	20	41,60
701602	9520271	4	M5	21,5	52,00
701603	9520280	5	M6	26	57,20
701604	9520298	6	M6	30	67,60

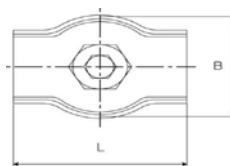

Sujetacables plano simple INOX

MIKALOR

Ref. INOX	Código INOX	Ø Cable mm	Medida	S mm	L mm	€/100
701700	9524352	3	M4	14	20	73,00
701701	9524360	4	M4	17	21,5	103,00
701702	9524379	5	M5	21	26	143,00
701703	9524387	6	M6	25	30	196,00

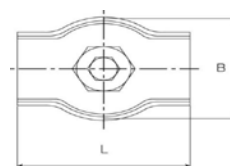

Sujetacables plano doble

MIKALOR

Ref.	Código	Ø Cable mm	L mm	B mm	€/100
701800	9520351	2	37	12,6	41,60
701801	9520360	3	40	14	46,80
701802	9520378	4	43	17	57,20
701803	9520386	5	52	21	78,00
701804	9520407	6	60	25	114,40
701805	9520394	8	72	31	208,00

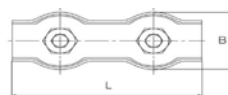

Sujetacables plano doble INOX

MIKALOR

Ref. INOX	Código INOX	Ø Cable mm	Medida	L mm	S	€/100
701900	9524459	3	M4	40	14	150,00
701901	9524467	4	M5	43	17	205,00
701902	9524475	5	M6	52	21	275,00
701903	9524483	6	M6	60	25	375,00

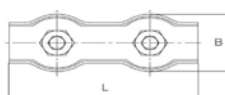

Cáncamo macho DIN 580

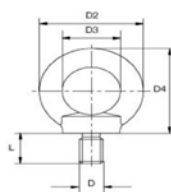

Ref.	Código	Medida	Carga trabajo S.W.L. kg	D1 mm	D2 mm	D3 mm	€/100
702000	9522613	M6	90	6	36	20	130,00
702001	9522621	M8	140	8	36	20	140,40
702002	9522630	M10	230	10	45	25	202,80
702003	9522648	M12	340	12	54	30	270,40
702004	9522656	M14	500	14	54	30	447,20
702005	9522664	M16	700	16	63	35	468,00
702006	9522672	M18	930	18	63	35	624,00
702007	9522680	M20	1.200	20	72	40	676,00

Ref.	Código	Medida	Carga trabajo S.W.L. kg	D1 mm	D2 mm	D3 mm	€/100
702008	9522699	M22	1.500	22	72	40	1.092,00
702009	9522701	M24	1.800	24	90	50	1.456,00
702010	9522710	M27	2.500	27	98	54	2.912,00
702011	9522728	M30	3.600	30	108	60	3.016,00
702012	9522736	M33	4.200	33	108	60	4.472,00
702013	9522744	M34	5.100	36	126	70	4.680,00
702014	9522752	M42	7.000	42	144	80	7.800,00
702015	9522760	M48	8.600	48	160	90	12.480,00

Cáncamo hembra DIN 582

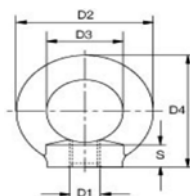

Ref.	Código	Medida	Carga trabajo S.W.L. kg	D1 mm	D2 mm	D3 mm	€/100
702100	9522816	M6	90	6	36	20	135,20
702101	9522824	M8	140	8	36	20	145,60
702102	9522832	M10	230	10	45	25	208,00
702103	9522840	M12	340	12	54	30	291,20
702104	9522859	M14	500	14	54	30	468,00
702105	9522867	M16	700	16	63	35	499,20
702106	9522875	M18	930	18	63	35	676,00
702107	9522883	M20	1.200	20	72	40	728,00

Ref.	Código	Medida	Carga trabajo S.W.L. kg	D1 mm	D2 mm	D3 mm	€/100
702108	9522891	M22	1.500	22	72	40	1.040,00
702109	9522904	M24	1.800	24	90	50	1.456,00
702110	9522912	M27	2.500	27	98	54	2.912,00
702111	9522920	M30	3.600	30	108	60	3.328,00
702113	9522939	M34	5.100	36	126	70	5.200,00
702114	9522947	M42	7.000	42	144	80	8.320,00
702115	9522955	M48	8.600	48	160	90	12.480,00

Cáncamo macho DIN 580 INOX



Ref. INOX	Código INOX	D1	Carga trabajo S.W.L. kg	D2 mm	D3 mm	D4 mm	L mm	€/100
702200	9525099	M 6	80	36	20	36	13	180,00
702201	9525101	M 8	150	36	20	36	13	305,00
702202	9525110	M 10	250	45	25	45	17	550,00
702203	9525128	M 12	370	54	30	53	20,5	850,00
702204	9525136	M 14	540	63	35	62	27	1.100,00
702205	9525144	M 16	770	63	35	62	27	1.400,00
702206	9525152	M 20	1.320	72	40	71	30	2.100,00
702207	9525160	M 24	1.700	90	50	90	36	4.400,00

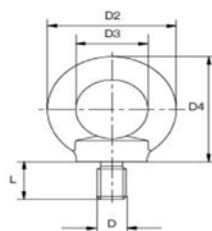

Cáncamo hembra DIN 582 INOX

MIKALOR

Ref. INOX	Código INOX	D1	Carga trabajo S.W.L. kg	D2 mm	D3 mm	D4 mm	S mm	€/100
702300	9525240	M 6	80	36	18	36	8,5	180,00
702301	9525259	M 8	150	36	20	36	8,5	250,00
702302	9525267	M 10	250	45	25	45	10	430,00
702303	9525275	M 12	370	54	30	53	11	1.000,00
702304	9525283	M 14	540	63	35	62	13	1.100,00
702305	9525291	M 16	770	63	35	62	13	1.200,00
702306	9525304	M 20	1.320	72	40	71	16	3.600,00
702307	9525312	M 24	1.700	90	50	90	20	3.700,00

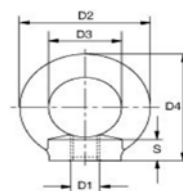

Grillete recto cabeza cuadrada

MIKALOR

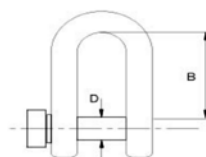

Ref.	Código	D mm	Carga trabajo S.W.L. kg	B mm	€/100
702400	9527406	5	80	19	71,76
702401	9527414	6	100	24	74,88
702402	9527422	8	200	30	114,40
702403	9527430	10	320	40	187,20
702404	9527449	11	400	44	260,00
702405	9527457	12	520	48	280,80

Ref.	Código	D mm	Carga trabajo S.W.L. kg	B mm	€/100
702406	9527465	14	650	53	405,60
702407	9527473	16	800	64	603,20
702408	9527490	19	1.100	72	936,00
702409	9527502	22	1.500	83	1.456,00
702410	9527510	25	2.100	93	2.080,00

Grillete recto cabeza punzón INOX

MIKALOR

Ref. INOX	Código INOX	Medida	Carga trabajo S.W.L. kg	A mm	B mm	€/100
702500	9524758	4	100	8	16	185,00
702501	9524766	5	120	10	19	205,00
702502	9524774	6	150	12	24	230,00
702503	9524782	8	250	16	32	360,00
702504	9524790	10	400	20	40	600,00
702505	9524803	12	600	25	48	900,00
702506	9524811	14	800	28	56	1.700,00
702507	9524820	16	1.000	32	64	2.200,00
702508	9524838	19	1.500	38	76	4.400,00
702509	9524846	25	3.000	50	95	9.600,00

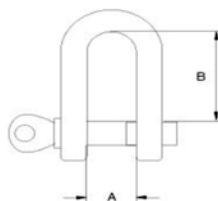

Grillete recto cabeza punzón



Ref.	Código	Medida	Carga trabajo S.W.L. kg	A mm	B mm	€/100
702600	9523413	5	80	10	19	70,72
702601	9523421	6	100	12	24	75,92
702602	9523430	8	200	16	32	104,00
702603	9523448	10	320	20	40	166,40
702604	9525670	11	400	22	44	218,40
702605	9523456	12	520	25	48	239,20
702606	9523464	14	650	28	56	364,00
702607	9523472	16	800	32	64	546,00
702608	9523480	18	1.000	36	71	780,00
702609	9523499	19	1.100	38	76	832,00
702610	9523501	22	1.500	44	85	1.248,00

Ref.	Código	Medida	Carga trabajo S.W.L. kg	A mm	B mm	€/100
702611	9523510	25	2.100	50	95	1.872,00
702612	9523528	28	3.000	56	106	2.808,00
702613	9523536	32	3.500	64	120	4.680,00
702614	9525689	35	4.000	70	130	6.240,00
702615	9523552	38	5.000	76	145	7.800,00
702616	9523560	42	8.000	76	145	14.560,00
702617	9523579	45	8.400	80	155	16.640,00
702618	9523587	50	9.600	90	175	29.120,00
702619	9523595	56	16.000	100	190	57.200,00
702620	9523608	63	20.000	115	215	78.000,00

Grillete de lira HA-2



Ref.	Código	Medida nominal pulg.	Carga límite trabajo Tn	A mm	B mm	H mm	Peso kg	€/ u.
21021068	6GARLCP014BEZ	1/4	0.5	11.9	7.85	46.7	0.05	2,62
21021069	6GARLCP516BEZ	5/16	0.75	13.5	9.65	53	0.09	2,93
21021070	6GARLCP038BEZ	3/8	1	16.8	11.2	63	0.14	3,27
21021071	6GARLCP716BEZ	7/16	1.5	19.1	12.7	74	0.17	3,98
21021072	6GARLCP012BEZ	1/2	2	20.6	16	83.5	0.33	5,45
21021073	6GARLCP058BEZ	5/8	3.25	26.9	19.1	106.1	0.62	8,19
21021074	6GARLCP034BEZ	3/4	4.75	31.8	22.4	126	1.07	11,03
21021075	6GARLCP078BEZ	7/8	6.5	36.6	25.4	148	1.64	14,45
21021076	6GARLCP100BEZ	1	8.5	42.9	28.7	172	2.28	22,36



Grillete HA-1 recto



Ref.	Código	Medida nominal pulg.	Carga límite trabajo Tn	A mm	B mm	K mm	Peso kg	€/ u.
21021077	6GARRCP014BEZ	1/4	0.05	11.9	7.85	48.5	0.05	2,59
21021078	6GARRCP516BEZ	5/16	0.08	13.5	9.65	58.5	0.08	2,86
21021079	6GARRCP038BEZ	3/8	0.13	16.8	11.2	67.5	0.13	3,28
21021080	6GARRCP716BEZ	7/16	0.2	19.1	12.7	77	0.2	3,98
21021081	6GARRCP012BEZ	1/2	0.27	20.6	16	95.5	0.27	5,45
21021082	6GARRCP058BEZ	5/8	0.57	26.9	19.1	115	0.57	8,21
21021083	6GARRCP034BEZ	3/4	1.2	31.8	22.4	135	1.2	10,30
21021084	6GARRCP078BEZ	7/8	1.43	36.6	25.4	151	1.43	14,46
21021085	6GARRCP100BEZ	1	2.15	42.9	28.7	172	2.15	22,40



Grillete HC-2 de lira con pasador y tuerca



Ref.	Código	Medida nominal pulg.	Carga límite trabajo Tn	A mm	B mm	H mm	Peso kg	€/ u.
21021091	6GARLTP012BEZ	1/2	2	20.6	16	83.5	0.36	7,84
21021092	6GARLTP058BEZ	5/8	3.25	26.9	19.1	106.1	0.52	10,23
21021093	6GARLTP034BEZ	3/4	4.75	31.8	22.4	126	1.23	14,81
21021094	6GARLTP078BEZ	7/8	6.5	36.6	25.4	148	1.79	21,63
21021095	6GARLTP100BEZ	1	8.5	42.9	28.7	172	2.28	27,78



Grillete HC-1 recto con pasador y tuerca



Ref.	Código	Medida nominal pulg.	Carga límite trabajo Tn	A mm	B mm	K mm	Peso kg	€ / u.
21021101	6GARRTP058BEZ	5/8	0.57	26.9	19.1	115	0.67	10,27
21021102	6GARRTP034BEZ	3/4	1.2	31.8	22.4	135	1.14	14,94
21021103	6GARRTP078BEZ	7/8	1.43	36.6	25.4	151	1.74	21,71
21021104	6GARRTP100BEZ	1	2.15	42.9	28.7	172	2.52	27,69



Cuerda cableada Sisal

ROMBULL

Ref.	Código	Descripción	Resistencia kg	€ / u.
700010	437012000900	4c 8mm 100m	473	40,43
700011	437014000900	4c 10mm 100m	622	51,86
700012	437016000900	4c 12mm 100m	936	78,34
700013	437017000900	4c 14mm 100m	1.260	103,89
700014	437018000900	4c 16mm 100m	1.770	140,98
700015	437019000900	4c 18mm 100m	2.100	163,18
700016	437020000900	4c 20mm 100m	2.790	204,99



Cuerda PES trenzada con alma 100%

ROMBULL

Ref.	Código	Descripción	Color	Resistencia kg	€ / u.
700020	420012000950	8mm 100m	Amarillo fluor	1.000	69,70
700021	429014000950	10mm 100m	Amarillo fluor	1.100	110,72
700022	429016000950	12mm 100m	Amarillo fluor	1.350	169,45
700023	429017000950	14mm 100m	Amarillo fluor	3.530	204,62
700024	429018000950	16mm 100m	Amarillo fluor	4.300	232,86



Cuerda Fibra ISO 1140

ROMBULL

Ref.	Código	Descripción	Color	Resistencia kg	€ / u.
700025	455014000944	ISO 1140 a 10 PA 2/100m	Blanco	2.000	109,95
700026	455016000944	ISO 1140 a 12PA 2/100m	Blanco	3.000	131,12
700027	455017000944	ISO 1140 a 14 PA 2/100m	Blanco	4.000	172,20
700028	455018000944	ISO 1140 a 16 PA 2/100m	Blanco	5.000	232,82



Cuerda trenzada PPM con alma 100%

ROMBULL

Ref.	Código	Descripción	Color	Resistencia kg	€ / u.
700030	424410000964	CTA100 PP 6mm 100m	Camel	425	29,45
700031	424412000964	CTA100 PP 8mm 100m	Camel	615	50,07
700032	428014000964	CTA100 PP 10mm 100m	Camel	642	72,80
700033	428016000964	CTA100 PP 12mm 100m	Camel	1.269	107,04
700034	428017000964	CTA100 PP 14mm 100m	Camel	1.800	137,05



Cuerda PES trenzada con alma 100%



Ref.	Código	Descripción	Color	Resistencia kg	€ / u.
700035	429014000944	10mm 100m	Blanco	2.100	71,69
700036	429016000944	12mm 100m	Blanco	2.550	102,30
700037	429017000944	14mm 100m	Blanco	3.530	144,45
700038	429018000944	16mm 100m	Blanco	4.300	184,01
700039	429019000944	18mm 100m	Blanco	5.596	224,64
700040	429020000944	20mm 100m	Blanco	6.300	262,93



Cuerda arranque motores



Ref.	Código	Descripción	Color	Resistencia kg	€ / u.
700042	420007000944	4mm 100m	Blanco	407	14,34



Red elástica



Ref.	Código	Descripción	€ / u.
700045	703100002766	Red elástica motocicleta negra	16,08
700046	703100002469	Red elástica maletero negro con gancho	27,19
700047	703100002666	Red elástica remolque negra grande	32,16
700048	703100002566	Red elástica remolque negra pequeña	24,42

Cuerda trenzada PES con alma 100%



Ref.	Código	Descripción	Color	Resistencia kg	€ / u.
700050	429014000911	10mm 100m	Verde	2.100	100,65
700051	429014000922	10mm 100m	Azul	2.100	100,65
700052	429014000933	10mm 100m	Rojo	2.100	100,65
700053	429014000966	10mm 100m	Negro	2.100	100,65
700054	429016000911	12mm 100m	Verde	2.550	154,05
700055	429016000922	12mm 100m	Azul	2.550	154,05
700056	429016000933	12mm 100m	Rojo	2.550	154,05
700057	429016000966	12mm 100m	Negro	2.550	154,05
700058	429017000911	14mm 100m	Verde	3.530	186,02
700059	429017000922	14mm 100m	Azul	3.530	186,02
700060	429017000933	14mm 100m	Rojo	3.530	186,02
700061	429017000966	14mm 100m	Negro	3.530	186,02



08

Pack pulpo

ROMBULL

Ref.	Código	Descripción	Resistencia kg	€/ u.
700065	701113000636	9Mm/100cm p/roja con gancho fuerte 2 ud	110	9,08
700066	701112000726	8Mm/100cm negro p/azul con gancho 2 ud	110	7,93
700067	701199001016	8Mm/100cm p/verde ajustable con gancho 2 ud	110	7,18



701113000636



701112000726



701199001016

Cuerda elástica PES

ROMBULL

Ref.	Código	Descripción	Color	€/ u.
700070	451012000944	Cuerda elástica PES 8mm 100m	Blanco	90,26
700071	451012000966	Cuerda elástica PES 8mm 100m	Negro	103,40
700072	451012000922	Cuerda elástica PPM 8mm 100m	Azul	96,65
700073	451014000944	Cuerda elástica PES 10mm 100m	Blanco	144,24
700074	451014000966	Cuerda elástica PES 10mm 100m	Negro	150,99
700075	451014000922	Cuerda elástica PPM 10mm 100m	Azul	144,24
700076	451016000944	Cuerda elástica PES 12mm 100m	Blanco	193,27
700077	451016000966	Cuerda elástica PES 12mm 100m	Negro	200,01
700078	451016000922	Cuerda elástica PPM 12mm 100m	Azul	193,27



451012000944



451012000966



451012000922

Cadena grado 80

BEZABALA

DIN EN 812-2

Ref.	Grosor cadena	Carga límite trabajo kg	t mm	b mm	Peso kg/m	€/ m.
703050	6 - 8	1.120	18	8,0	0,8	7,83
703051	7 - 8	1.500	21	10,5	1,1	10,06
703052	8 - 8	2.000	24	10,8	1,5	12,49
703053	10 - 8	3.150	30	13,5	2,3	17,63
703054	13 - 8	5.300	39	17,5	3,8	28,98
8000283	16-8	8.000	48	21,5	6,1	46,75
8000284	18-8	10.000	54	24,3	7,3	96,43
8000285	19-8	11.200	57	25	8,5	120,78
8000286	20-8	12.500	60	27	9	155,41
8000287	22-8	15.000	66	29,5	10,9	246,09
8000288	26-8	21.200	78	35	15,2	313,35
8000289	32-8	31.500	96	52	22,7	311,01

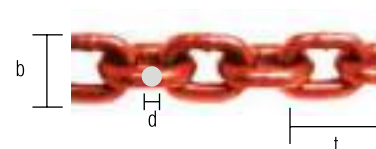

Cadena comercial



Ref.	€/m	Ref.	€/m	Ref. INOX	€/m	Diámetro mm	Paso t	Anch. Exte. b	Carga útil	Peso kg/m	Material
702700	13,39	702800	17,20	702900	2,23	2	13	11	-	0,07	Cincada
702701	10,34	702801	14,00			2,5	16	9,5	-	0,107	Cincada
702702	9,57	702802	12,86	702902	4,86	3	18	11	-	0,16	Cincada
702703	7,93	702803	9,86	702903	8,63	4	21	15	120	0,30	Cincada
702704	6,78	702804	8,09	702904	12,31	5	27	19	220	0,47	Cincada
702705	6,56	702805	7,78	702905	18,68	6	27	23	275	0,70	Cincada
702706	6,53	702806	7,68	702906	24,32	7	31	26	450	1,00	Cincada
702707	6,51	702807	7,68	702907	31,74	8	34	31	500	1,35	Cincada
702708	6,49	702808	7,46			9	38	32	750	1,60	Cincada
702709	6,47	702809	7,46	702909	51,19	10	35	34	1.000	2,05	Cincada
702710	6,43	702810	7,22	702910	83,76	12	42	41	1.350	2,90	Cincada

Cáncamo giratorio



Ref.	Código	Capacidad kg	€/ u.
21058000	PHCG81303	300	28,00
21058001	PHCG101804	500	28,00
21058002	PHCG121805	500	30,00
21058003	PHCG142011	1120	31,00
21058004	PHCG162011	1120	31,00
21058005	PHCG203020	2000	55,00
21058006	PHCG243031	3200	82,00
21058007	PHCG273531	3200	93,00
21058008	PHCG303553	5000	124,00
21058009	PHCG303580	8000	197,00
21058010	PHCG365080	8000	204,00
21058011	PHCG395080	8000	226,00
21058012	PHCG425010	10000	237,00
21058013	PHCG485010	10000	256,00
21058014	PHCG568410	15000	452,00
21058015	PHCG649615	15000	615,00



Cáncamo giratorio. Lateral largo



Ref.	Código	Capacidad kg	€/ u.
21058029	PCGAL876036	360	37,00
21058030	PCGAL1096063	630	45,00
21058031	PCGAL1211410	1000	75,00
21058032	PCGAL1414012	1200	85,00
21058033	PCGAL1614915	1500	90,00
21058034	PCGAL1818020	2000	95,00
21058035	PCGAL2018625	2500	100,00
21058036	PCGAL2422140	4000	125,00
21058037	PCGAL2727040	4000	194,00
21058038	PCGAL3027850	5000	#N/A
21058039	PCGAL3622270	7000	315,00
21058040	PCGAL42264100	10000	500,00
21058041	PCGAL48295200	20000	562,00



Cáncamo giratorio abatible



Ref.	Código	Capacidad kg	€/ u.
21058042	PCGM81205	500	45,00
21058043	PCGM101607	700	50,00
21058044	PCGM121810	1000	55,00
21058045	PCGM142115	1500	60,00
21058046	PCGM162420	2000	65,00
21058047	PCGM204030	3000	110,00
21058048	PCGM244045	4500	120,00
21058049	PCGM304573	7300	215,00
21058050	PCGM335080	8000	225,00
21058051	PCGM3654100	10000	235,00
21058052	PCGM3958100	10000	245,00
21058053	PCGM4263125	12500	260,00
21058054	PCGM4563150	15000	370,00
21058055	PCGM4868200	20000	385,00
21058056	PCGM5268200	20000	405,00
21058057	PCGM5678250	25000	510,00
21058058	PCGM6490320	32000	595,00



Cáncamo giratorio abatible largo



Ref.	Código	Capacidad kg	€/ u.
21058059	PCGML87605	500	75,00
21058060	PCGML109607	700	85,00
21058061	PCGML1211410	1000	100,00
21058063	PCGML1614920	2000	110,00
21058064	PCGML2018630	3000	165,00
21058065	PCGML2422145	4500	175,00
21058066	PCGML3027873	7300	325,00
21058068	PCGML36222100	10000	365,00
21058070	PCGML42264125	12500	395,00
21058072	PCGML48295200	20000	605,00
21058073	PCGML52250200	20000	625,00
21058074	PCGML56250250	25000	715,00
21058075	PCGML64250320	32000	785,00



Cáncamo giratorio lateral



Ref.	Código	Capacidad kg	€/ u.
21058016	PCGA811036	360	28,00
21058017	PCGA1016063	630	34,00
21058018	PCGA121810	1000	51,00
21058019	PCGA142112	1200	60,00
21058020	PCGA162415	1500	64,00
21058021	PCGA182620	2000	70,00
21058022	PCGA203025	2500	85,00
21058023	PCGA243540	4000	95,00
21058024	PCGA273840	4000	137,00
21058025	PCGA304850	5000	165,00
21058026	PCGA365470	7000	240,00
21058027	PCGA4272100	10000	395,00
21058028	PCGA4874200	20000	540,00





Cáncamo macho giratorio

Ref.	Código	Capacidad kg	€ / u.
21058076	PHCMG08	800	15,00
21058077	PHCMG10	1000	17,00
21058078	PHCMG12	2000	19,00
21058079	PHCMG16	4000	25,00
21058080	PHCMG20	6000	36,00
21058081	PHCMG24	8000	40,00
21058082	PHCMG30	12000	85,00
21058083	PHCMG36	16000	100,00



Anilla simple grado 80 sin parte plana



Pulpo de cadena de 1 y 2 ramales. EN 818-4 Pulpo de cable de 1 y 2 ramales. EN 13414-1



Ref.	Medida nominal	Carga max t	DIN 5688 1 ramal	DIN 5688 2 ramales	DIN 3088 1 ramal	DIN 3088 2 ramales	d mm	w mm	l mm	Peso kg	€ / u.
703100	A 13	1,60	6/7-8	6-8	-	-	13	110	60	0,3	6,55
703101	A 16	2,12	8-8	7-8	8/10/12/14	8/10/12	16	110	60	0,5	9,75
703102	A 18	3,15	10-8	8-8	16/18	14/16	18	135	75	0,8	11,56
703103	A 22	5,30	13-8	10-8	20/22/24	18/20	22	160	90	1,6	20,93
703104	A 26	8,00	16-8	13-8	26/28	22	26	180	100	2,3	32,13
8000290	A 32	11,2	18-8	16-8	32	24	32	200	110	3,9	57,78
8000291	A 36	14	19/20-8	18-8	36/40	26	36	260	140	6,4	93,02
8000292	A 40	17	22-8	19/20-8	-	28/32	40	300	160	8,9	125,96
8000293	A 45	21,2	26-8	22-8	48/52	34/40	45	340	180	12,8	189,00
8000294	A 50	31,5	32-8	26-8	56	-	50	350	190	16,6	314,01
8000295	A 58	45	36-8	32-8	-	-	58	400	200	23,3	461,97
8000296	A 70	63	40-8	36-8	70	-	70	460	250	45,8	624,11
8000297	A 80	85,46	-	-	-	45-8	80	500	270	62,0	826,47

Anilla triple para cadena grado 80 sin parte plana



Pulpo de cadena de 3 y 4 ramales. EN 818-4

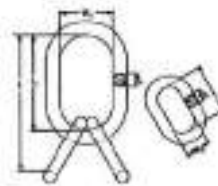

Ref.	Medida nominal	Carga max t	d1 mm	l1 mm	w1 mm	d2 mm	l2 mm	w2 mm	t mm	Peso kg	€ / u.
703200	6/7-8	2,36	18	135	75	13	54	25	189	1,2	23,69
703201	8-8	4,25	22	160	90	16	70	34	230	2,3	41,77
703202	10-8	6,70	26	180	100	18	85	40	265	3,4	61,95
703203	13-8	11,20	32	200	110	22	115	50	315	6,1	111,27
8000298	16-8	17,0	36	260	140	26	140	65	400	9,9	157,25
8000299	18-8	21,2	45	340	180	32	180	100	520	18,9	181,82
8000300	19/20-8	26,5	50	350	190	32	180	100	530	22,6	582,31
8000301	22-8	31,5	50	350	190	36	180	100	530	25,2	780,27
8000302	26-8	45,0	56	400	200	40	180	100	580	35,2	1.392,42
8000303	32-8	63,0	72	460	250	50	200	110	660	66,5	2.751,84

Unión doble cadena modelo VG



Pulpo de cadena de 3 y 4 ramales. EN 818-4

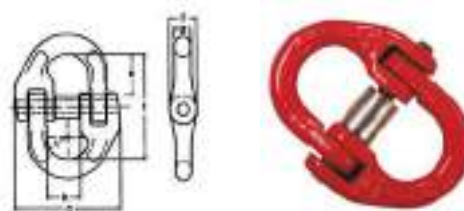

Ref.	Medida nominal	Carga límite trabajo kg	c mm	e mm	f mm	g mm	k mm	r mm	t mm	Peso kg	€/ u.
703800	6-8	1.120	42	15	15	7	14	7,5	42	0,08	7,90
703801	7/8-8	2.000	60,5	18	18	8,5	20	9,5	60,5	0,146	11,76
703802	10-8	3.150	68	25	25	11,5	26	12	68	0,3	12,99
703803	13-8	5.300	87	29	29	15	27	15	87	0,65	22,64
8000304	16-8	8.000	108,4	34,5	34,5	19,8	34,5	19,8	108,4	1,15	35,28
8000305	19/20-8	12.500	121,5	41,0	41	24	41	24	121,5	2,1	60,02
8000306	22-8	15.000	141,5	48	48	26	48	26	141,5	2,87	100,91
8000307	26-8	21.200	158	57,5	57,5	30	57,5	31	158	4,5	141,63
8000308	32-8	31.500	205	67	67	37	67	38	205	8,21	289,93

Cáncamo giratorio BMD



Ref.	Código	Carga límite trabajo Tn	A mm	B mm	E mm	Apriete Nm	Peso kg	€/ u.
21021018	BMDM8	0.3	55	36	13	10-40	0.41	98,20
21021019	BMDM10	0.5	55	36	18	10-40	0.43	101,36
21021020	BMDM12	0.5	55	36	18	15-40	0.44	105,58
21021021	BMDM16	1.12	55	36	35	45-130	0.46	110,93
21021022	BMDM20	2	70	49,5	30	100-170	0.96	128,47
21021023	BMDM24	3.15	85	57	30	190-280	1.45	173,08
21021024	BMDM30	5.3	85	66	35	270-600	2.17	223,70
21021025	BMDM36	8	115	80	50	270-600	4.17	289,41
21021027	BMDM42	10	115	80	50	350-800	3.62	402,71



Gancho de acceso directo de cadena, modelo GHS, con sólido pestillo seguridad



Ref.	Medida nominal	Carga límite trabajo kg	A mm	d mm	h mm	l mm	m mm	s mm	Peso kg	€/ u.
704000	6/7-8	1.120	8	32	35	23	76	26	0,32	7,55
704002	7/8-8	2.000	9,5	37	37	32,5	58,5	29	0,48	11,06
704003	10-8	3.150	13	46	46	35	104	39	0,95	20,18
704004	13-8	5.300	16,5	56	56	42,5	128	27	1,8	38,79
8000309	16-8	8.000	21,5	60	60	54	150	55	3,4	73,18
8000310	19/20-8	12.500	24	79	79	58	180	61	6	126,01
8000311	22-8	15.000	27	101	101	62	213	72	10,4	180,06
8000312	26-8	21.200	30	115	115	75	250	85	14,5	237,63

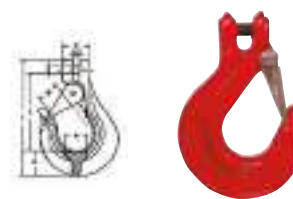

Gancho de seguridad modelo CLS



Ref.	Medida nominal	Carga límite trabajo kg	B mm	E mm	E1 mm	L1 mm	L1 mm	L mm	Peso kg	€/ u.
704600	6-8	1.120	21	35	28	141	110	141	0,5	19,85
704601	7/8-8	2.000	25	40	35	175	136	175	0,88	23,90
704602	10-8	3.150	34,5	50	45	214	168	214	1,58	42,39
704603	13-8	5.300	40	60	52,5	268	207	268	3	89,64
8000313	16-8	8.000	50	65	63,3	332	254	332	5,9	180,63
8000314	18/20-8	12.500	64,5	80	86	360	274,5	332	7	261,36
8000315	22-8	15.000	70	83	76	415	319	415	12,3	427,28
8000316	26-8	21.200	80	106	96	472	362	472	20	722,12
8000317	32-8	31.500	105	140	133	614	470	614	44	2.704,59





Gancho de seguridad modelo VHG

Ref.	Medida nominal	Carga límite trabajo kg	E mm	A mm	H mm	W mm	L mm	Peso kg	€ / u.
704902	6-8	1.120	8,3	8	19,5	21,5	75	0,25	6,71
8005020	7/8-8	2.000	11	9,5	18,5	33,5	89	0,32	12,50
704903	10-8	3.150	13	12,5	29	46	126	0,73	28,88
704904	13-8	5.300	16,5	15	42,5	57,5	163,5	1,6	38,80
8005021	16-8	8.000	19	18,5	47	74	183,5	2,8	68,24
8005022	18/20-8	12.500	24	23	56	74	219	5	135,27
8005023	22-8	15.000	37	27	68,5	90	254	6,3	273,11
8005024	26-8	21.200	30	30	77	102	309	14,5	547,56

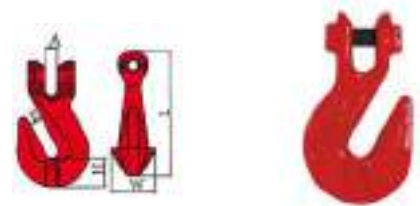

Gancho SOB



Ref.	Medida nominal	Carga límite trabajo kg	B mm	E mm	D mm	A mm	L mm	Peso kg	€ / u.
21021000	6-8	1.120	9	24	21	20	108	0,3	5,05
21021001	7/8-8	2.000	11	30	26	25	133	0,4	8,45
21021002	10-8	3.150	15	34	39	38	167	0,9	15,27
21021003	13-8	5.300	19	39	54	43	213	1,7	25,57
21021004	16-8	8.000	23	46	64	50	255	3,2	42,40
21021005	18/20-8	12.500	24	50	80	62	305	5,8	97,61
21021006	22-8	15.000	32	71	80	62	348	8,5	166,73
21021007	26-8	21.200	35	81	82	64	394	13	223,16
21021008	32-8	31.500	37	12	112	88	480	17	880,47

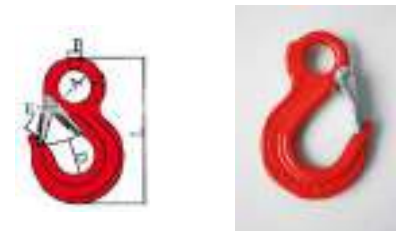

Gancho de seguridad modelo CLG



Ref.	Medida nominal	Carga límite trabajo kg	A mm	B mm	E mm	E1 mm	L1 mm	L mm	Peso kg	€ / u.
21021009	6-8	1.120	8	32	35	28	96	131	0,44	21,09
21021010	7/8-8	2.000	9,5	48	40	35,8	119,3	161,8	0,8	25,49
21021011	10-8	3.150	12,5	60	50	45	142	195	1,38	44,51
21021012	13-8	5.300	15	65	60	52,5	179	249	2,81	86,48
21021013	16-8	8.000	18,5	70	65	63,3	224,8	310	6	166,00
21021014	18/20-8	12.500	25	80	80	86	238,3	335	7,25	331,16
21021015	22-8	15.000	30	90	83	76	277	392	12,8	662,18
21021016	26-8	21.200	30	118	106	96	321	450	21,8	1.350,27
21021017	32-8	31.500	35	150	140	135	416	589,6	49,6	2.835,41

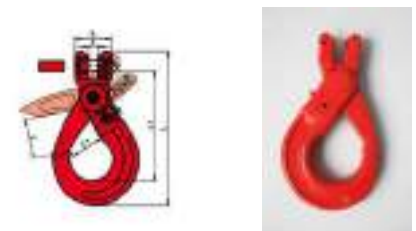

Cáncamo giratorio BMD-XP



Ref.	Código	Carga límite trabajo Tn	A mm	B mm	E mm	Apriete Nm	Peso kg	€ / u.
21021028	BMD-XPM12	0,7	53	13	18	15-40	0,4	105,58
21021030	BMD-XPM16	1,4	53	13	24	45-130	0,5	110,93
21021031	BMD-XPM20	2,5	59	16	30	100-170	1	128,47
21021032	BMD-XPM24	4	73	19	36	190-280	1,5	173,08
21021033	BMD-XPM30/6	6,7	68	19	50	230-400	2,5	223,70
21021034	BMD-XPM30/8	8	95	22	45	270-600	3,7	267,71
21021035	BMD-XPM36	10	95	22	54	270-600	3,9	289,41
21021036	BMD-XPM42	13	129	32	60	350-800	7,4	685,18



Cáncamo giratorio BZG



Ref.	Código	Carga límite trabajo Tn	A mm	B mm	E mm	Apriete Nm	Peso kg	€/ u.
21021047	BZGM8	0.3	30	35	11	30	0.2	36,81
21021048	BZGM10	0.63	30	35	16	60	0.3	37,96
21021049	BZGM12	1	33	37	18	100	0.5	47,55
21021050	BZGM14	1.2	33	37	21	120	0.5	55,50
21021051	BZGM16	1.5	33	37	24	150	0.5	56,00
21021053	BZGM20	2.5	50	54	30	250	1.3	81,72
21021054	BZGM24	4	50	54	36	400	1.4	105,04
21021055	BZGM27	4	60	65	38	400	2.8	140,12
21021056	BZGM30	5	60	65	48	500	3.1	140,12



Cáncamo macho giratorio con llave BZGLL



Ref.	Código	Carga límite trabajo Tn	A mm	B mm	E mm	Apriete Nm	Peso kg	€/ u.
21021060	BZGLLM10	0.4	36	25	15	10	0.1	34,30
21021061	BZGLLM12	0.75	45	30	18	10	0.2	38,48
21021062	BZGLLM16	1.5	52	35	24	30	0.3	44,02
21021063	BZGLLM20	2.3	60	40	30	70	0.6	64,80
21021064	BZGLLM24	3.2	74	48	36	150	1	80,07
21021065	BZGLLM30	4.5	90	60	45	350	1.8	115,79
21021066	BZGLLM36	7	109	72	54	410	3.2	179,90



Garra "TOPAL" modelo KF-KT



Adecuado para la elevación vertical de chapas, vigas y estructuras de acero, la pinza KF-KT dispone de un resorte de seguridad para una presión de contacto continua. Dependiendo del peso de la carga, la pinza sólo dejará una marca en un lado. Pinzas para chapas ligeras y de uso esporádico. Uso vertical Desbloqueo manual Marca unilateral Pinza de bajo coste para la sujeción de presupuestos Dureza hasta 300 HB

Ref.	Código	Capacidad kg	Apertura mm	€/ u.
707200	189418	750	0-15	153,00
707201	189928	1.000	0-20	212,00



Garra multiposición modelo KS



Adecuada para levantar chapas, vigas, perfiles y estructuras de acero desde cualquier posición, la pinza KS tiene un resorte de seguridad y, dependiendo del peso de la carga, sólo deja una marca en un lado. Uso horizontal y vertical Desbloqueo manual Marca unilateral Revestimiento epoxi en caliente Dureza hasta 300 HB

Ref.	Código	Capacidad kg	Apertura mm	€/ u.
707300	50238	750	0-15	355,00
707301	50248	1.000	0-20	465,00
707302	50258	2.000	0-25	564,00
707303	50268	3.000	0-30	960,00



Garra automática vertical-horizontal NK



Pinza de elevación de cierre automático adecuada para elevar chapas, vigas, perfiles y estructuras de acero desde cualquier posición. Versión para uso intensivo. La pinza tiene un resorte de seguridad para una presión de contacto continua y, dependiendo del peso de la carga, sólo deja una marca en un lado. Especialmente diseñada para entornos difíciles. Coeficiente de seguridad superior a las exigencias norma EN13155 Uso horizontal y vertical Cierre automático Desbloqueo manual Revestimiento epoxi en caliente Dureza hasta 330 HB Para elevación y volteo de cargas

Ref.	Código	Capacidad kg	Apertura mm	€ / u.
707400	50288	1.500	0-20	807,00
707401	50298	1.500	20-40	1.095,00
707402	50308	1.500	40-60	1.295,00



Garra articulada modelo BT



Ref.	Código	Capacidad kg	Capacidad de apertura m/m	Peso kg	€ / u.
1308640	AGU051	500	0-15	1,9	120,00
1308641	AGU101	1.000	0-20	4,6	135,00
1308642	AGU201	2.000	0-25	7,3	185,00
1308643	AGU301	3.000	0-30	15,0	280,00
1308644	AGU501	5.000	0-50	21,5	385,00
1308645	AGU801	8.000	50-100	26,5	605,00



Garra automática materiales frágiles modelo NX



Pinza de elevación automática, sin marcas, de cierre automático, adecuada para la elevación de materiales lisos y pulidos como acero, acero inoxidable, aluminio, madera, piedra natural, hormigón, plástico o vidrio. Diseño patentado Las mordazas de sujeción tienen un revestimiento de poliuretano y, por lo tanto, no dejan marcas en la carga. La apertura de las mordazas del modelo NXR es ajustable y muy adecuada para cargas sensibles a la presión. No marcate Uso horizontal y vertical Cierre automático Desbloqueo manual Revestimiento epoxi en caliente

Ref.	Código	Capacidad kg	Apertura mm	€ / u.
707500	50408	500	0-20	932,00
707501	50418	1.500	0-30	1.373,00



Garra horizontal modelo TLH (utilización por parejas)



Pinza de elevación universal para el transporte horizontal de chapas, paquetes o piezas de construcción. Para uso en configuraciones de 2, 3 ó 4 pinzas. Fuerza de sujeción proporcional al peso de la carga. Cadena de elevación disponible bajo pedido. Muy fácil de usar No dejan marcas Revestimiento epoxi en caliente

Ref.	Código	Carga por pareja kg	Apertura mm	€ / u.
707600	51038	1.000	0-60	198,00
707601	51048	1.000	0-120	292,00



Garra de husillo modelo WF



Ref.	Código	Capacidad kg	Capacidad de apertura m/m	Peso kg	€ / u.
1308650	AGHUS050	500	3-28	1,5	346,00
1308651	AGHUS100	1000	3-40	2,9	541,00
1308652	AGHUS200	2000	3-45	4,9	706,00
1308653	AGHUS300	3000	6-49	7,2	840,00
1308654	AGHUS500	5000	9-53	10,0	1.094,00



Imanes permanentes modelo TPM



Los imanes de carga TPM son herramientas ideales para el transporte sencillo, rápido y económico de objetos pesados fabricados en material ferro-magnético. Las áreas de empleo habituales son talleres y almacenes, carga y descarga de maquinaria, así como la fabricación de utensilios y accesorios.

Ref.	Código	Capacidad máxima para materiales planos	Capacidad máxima para materiales redondos	€ / u.
2402485	N56400001	100	50	253,47
2402486	N56400002	300	150	575,10
2402487	N56400003	500	250	795,56
2402488	N56400004	800	400	1.062,87
2402489	N56400005	1.000	500	1.467,57
2402490	N56400006	2.000	1.000	3.334,52
2402491	192019927	3.000	1.500	5.988,50



Aparato TIRFOR



El tirfor®, uno de los productos insignia de Tractel®, es conocido en todo el mundo como el mejor cabrestante de cable, capaz de trabajar en cualquier posición y en cualquier altura de levantamiento con una longitud de cable ilimitada. El tirfor® es un dispositivo seguro, fiable y eficiente. Resulta muy adecuado cuando la altura de elevación o la longitud de arrastre son grandes o cuando se requiere una mayor capacidad. Es ligero, se instala con rapidez, incluye protección contra sobrecarga y requiere menos esfuerzo que otros cabrestantes de cable.

Ref.	Código	Modelo	Capacidad kg	Diámetro cable mm	Peso kg	€ / u.
708200	6109	T-7	750	8,3	7	265,00
708201	6119	T-13	1.500	11,5	17	830,00
21124000	18109	T-532	3.200	16,3	26,9	705,00



Tirador de cable modelo TCAL



Ref.	Código	Capacidad kg	Longitud estándar m	Diámetro cable mm	Peso sin cable kg	€ / u.
1308635	ATCA1000	800	20	8,3	6	190,00
1308636	ATCA2000	1600	20	11	11,5	280,00
1308637	ATCA3000	3200	20	16	22	450,00
1308638	ATCA4000	5400	20	20	56	1.215,00

Polipasto manual - TRALIFT™



El polipasto manual tralift™ está especialmente diseñado para elevar cargas en las condiciones más extremas. El polipasto manual de cadena manual tralift™ tiene un diseño único de Tractel® que es compacto, ligero y robusto, capaz de hacer frente a las condiciones de elevación más extremas. Ideal para flotas de alquiler, aplicaciones industriales y de construcción. Tractel® también ofrece tralift™ en formato negro para la industria del entretenimiento. Certificado por TÜV Rheinland según EN13157 para capacidades de 500kg y superiores cuando está equipado con cadena de carga Corolim Grado 8 EN818-7 que también ofrece una excelente protección contra la corrosión.



Ref.	Código	Carga kg	Longitud estandar m	Nº ramales	Peso con cadena kg	€/ u.
708451	272989	500	3	1	9,0	705,00
708452	272999	1000	3	1	12,4	247,00
708453	273009	1500	3	1	16,5	363,00
708454	273019	2000	3	2	17,2	468,00
708455	273039	3000	3	2	24,2	520,00
708456	273049	5000	3	2	42,0	520,00
708457	273059	10000	3	4	85,1	872,00
708458	273069	20000	3	8	165,1	2.226,00

Polipasto manual serie 630



Ref.	Código	Capacidad kg	Longitud estándar m	Nº ramales	Peso con cadena kg	€/ u.
1308610	AFK1000	250	3	1	3,5	165,00
1308611	AFK2000	500	3	1	8	155,00
1308612	AFK3000	1000	3	1	11	160,00
1308613	AFK4000	1500	3	1	15,2	215,00
1308614	AFK5000	2000	3	2	15,8	240,00
1308615	AFK6000	3000	3	2	22,4	290,00
1308616	AFK7000	4000	3	2	39	480,00
1308617	AFK8000	5000	3	2	39	510,00
1308618	AFK10000	7500	3	3	58	910,00
1308619	AFK11000	10000	3	4	68	970,00
1308620	AFK13000	15000	3	6	125	1.975,00
1308621	AFK14000	20000	3	8	154	2.250,00



Polipasto de palanca UNOplus-A



Con cadena de eslabones de acero zincada y selector punto neutro [Cadena libre]. Disponible en versión ATEX.

Ref.	Código	Capacidad en Kg / Ramales	€/ u.
2402509	192049841	750 / 1	309,96
2402510	192049940	1.500 / 1	369,36
2402511	192050025	3.000 / 1	570,24
2402512	192050579	6.000 / 2	911,52



Polipasto manual de cadena modelo Yalelift 360



Carcasas de acero, pintura epoxi, cadenas de carga y de mando zincada. Disponible en versión ATEX y anticorrosión

Ref.	Código	Capacidad en Kg / ramales	Suplemento por metro adicional (l m)	€/ u.
2402492	a	500 / 1	29	298,20
2402493	N04700110	1.000 / 1	30	350,39
2402494	N04700111	2.000 / 1	35	503,75
2402495	N04700112	3.000 / 1	53	733,79
2402496	N04700113	5.000 / 2	85	1.115,06
2402497	N04700075	10.000 / 3	140	2.107,64
2402498	N04700077	20.000 / 6	280	6.032,16



Polipasto manual de cadena con carro de empuje integrado modelo Yalelift ITP



Carcasas de acero, pintura epoxi, cadenas de carga y de mando zincada. Disponible en versión ATEX y anticorrosión

Ref.	Código	Capacidad en Kg / Ramales	Ancho ala de viga mm	Recorrido estándar m	€/ u.
2402499	N04900044	500 / 1	50 - 180	3	681,48
2402500	N04900045	1.000 / 1	50 - 180	3	785,16
2402501	N04900046	2.000 / 1	58 - 180	3	1.001,16
2402502	N04900047	3.000 / 1	74 - 180	3	1.672,92
2402503	N04900020	5.000 / 2	98 - 180	3	2.218,32



Polipasto manual de cadena con carro de traslación por cadena integrado modelo Yalelift ITG



Carcasas de acero, pintura epoxi, cadenas de carga y de mando zincada. Disponible en versión ATEX y anticorrosión

Ref.	Código	Capacidad en Kg / Ramales	Ancho ala de viga mm	Recorrido estándar m	€/ u.
2402504	N04900056	500 / 1	50 - 180	3	781,92
2402505	N04900057	1.000 / 1	50 - 180	3	897,48
2402506	N04900058	2.000 / 1	58 - 180	3	1.110,24
2402507	N04900059	3.000 / 1	74 - 180	3	1.819,80
2402508	N04900060	5.000 / 2	98 - 180	3	2.434,32



Polipasto de palanca - BRAVO™



Diseñados especialmente para arrastrar, elevar, posicionar o ajustar. Se pueden utilizar en cualquier posición: vertical, horizontal o inclinada

Ref.	Código	Carga kg	Longitud estándar m	Nº ramales	Peso con cadena kg	€/ u.
708701	244029	500	1,5	1	5,0	365,00
708702	244039	750	1,5	1	7,0	140,00
708703	244059	1.500	1,5	1	11,5	550,00
708704	244069	3.000	1,5	1	21,4	790,00
708706	244089	6.000	1,5	2	30,2	2.650,00
708705	244079	9.000	1,5	3	56,1	1.360,00



Polipasto de palanca "Palfer" serie 900



Ref.	Código	Capacidad kg	Longitud estándar m	Nº ramales	Peso con cadena kg	€/ u.
1308625	APA0250	250	1,5	1	2,3	125,00
1308626	APA0500	500	1,5	1	6,2	140,00
1308627	APA1000	750	1,5	1	7	180,00
1308628	APA2000	1.500	1,5	1	13	205,00
1308629	APA3000	3.000	1,5	1	20	325,00
1308630	APA4000	6.000	1,5	2	29	480,00
1308631	APA5000	9.000	1,5	3	44	740,00



Polipastos eléctricos modelo EC4 trifásicos



Ref.	Código	Capacidad kg	Longitud estándar m	Nº ramales	Peso kg	€/ u.
1308665	AEO1000	250	3	1	35	1.935,00
1308666	AEO2000	500	3	1	37	2.040,00
1308667	AEO3000	1000	3	1	49	2.270,00
1308668	AEO4000	2000	3	2	58	2.915,00
1308669	AEO5000	3000	4	1	102	4.510,00
1308670	AEO6000	5000	4	2	130	5.220,00



Polipasto mini eléctrico de cable modelo ME monofásico



Ref.	Código	Capacidad kg	Longitud estándar m	Nº ramales	Peso kg	€/ u.
1308673	AEMIN2550	250/500(2)	38/19(2)	1/2	29	800,00
1308674	AEMIN4080	400/800(2)	32/16(2)	1/2	31	890,00



Polipasto eléctrico - VOLT TRAC™



El polipasto se activa mediante un control colgante de bajo voltaje con tres botones: Elevación, descenso y parada de emergencia. El cuerpo del polipasto incluye un gancho de suspensión rígido u orejeta de suspensión (para montaje directo en un carro) para colocar el polipasto en una estructura de soporte. El gancho inferior (gancho de carga) está equipado con un rodamiento de bolas que ayuda a posicionar la carga. La carga se conecta al gancho de carga directamente o a través de un accesorio como una eslinga.

Ref.	Código	Modelo	Capacidad Tn	Nº ramales	Nº Velocidades	Peso kg	€/ u.
21124001	280209	VT250	0.25	1	1	24	1.700,00
21124002	280229	VT500	0.5	1	2	33	1.900,00
21124003	280219	VT500 2R	0.5	2	1	36	1.800,00
21124004	280269	VT1000	1	1	1	48	2.400,00
21124005	280259	VT1000 2R	1	2	2	51	2.250,00
21124006	280299	VT2000	2	1	2	56	2.900,00



Polipasto eléctrico



Ref.	8000861	8000862	8000863
Código	756810125	756810300	756810500
Fuerza portante (sin reenvío) Kgr.	125	300	500
Fuerza portante(con reenvío) Kgr.	250	600	999
Altura elevación (sin reenvío) m	12	18	18
Altura elevación (con reenvío) m	6	9	9
Velocidad de elevación (sin reenvío) m/min	10	10	10
Velocidad de elevación (con reenvío) m/min	5	5	5
Ø del cable mm	3	4	6
Resistencia del cable Kgr	900	1.400	1.400
Potencia W	500/230V	1.050/230V	1.600/230V
Dimensiones mm	325x130x150	390x150x190	490x175x275
Peso kgr.	11.5	17	30
€/ u.	128,00	200,00	345,00

Polipasto eléctrico de cadena modelo CPV (F)



Modelos CPV con una velocidad de elevación (disponible en doble velocidad). Precio con 3 m de recorrido de gancho, mando a baja tensión 42V, con 2,5 m de manguera de botonera, y finales de carrera eléctricos de elevación/descenso. Equipados con limitador de carga mediante embrague de deslizamiento.

Ref.	Código	Capacidad en Kg / Ramales	Velocidad de elevación m/min	€/ u.
2402513	NO6700562	250 kg / 1	8 m/ min	1.921,26
2402514	NO6700563	500 kg / 2	4 m/ min	2.044,80
2402515	NO6700617	500 kg / 1	8 m/ min	2.274,84
2402516	NO6700619	1.000 kg / 2	4 m/ min	2.547,48
2402517	NO6700621	1.000 kg / 1	8 m/ min	3.200,33
2402518	NO6700623	2.000 kg / 2	4 m/ min	3.645,50



Polipasto eléctrico de cable SH Ex



400v, 50Hz, con botonera 48V. ATEX Zona 2. INCLUIDO: 2 velocidades de elevación + 2 velocidades de traslación (20/5 m/min) con carro de altura reducida, cuadro de maniobra, botonera, limitador de carga electrónico, contador de horas de trabajo, protección termo-sonda en los dos motores, final de carrera eléctrico de subida / bajada.

Ref.	Código	Ramales	Capacidad kg	Altura m	€/ u.
8000928	SH3008-20 Exn	2	1.600	12	Consultar
8000929	SH3008-20 Exn	4	3.200	6	Consultar
8000930	SH4012-20 Exn	4	5.000	6	Consultar
8000931	SH4016-16 Exn	4	6.300	6	Consultar



08

Minifor™



El aparato Minifor™ es un aparato elevador motorizado y portátil a cable pasante. Puede levantar cargas o tirar de ellas a lo largo de una gran longitud, manteniendo al mismo tiempo el par máximo. Se puede utilizar en diversas configuraciones. El aparato se controla mediante una botonera colgante. Como opción, el aparato elevador Minifor™ puede incorporar un enrollador de cable y/o un mando a distancia vía radio



TR-30



TR-50

Ref.	Código	Modelo	€/ u.
8002892	47499	TR-30	4.200,00
8002893	47529	TR-50	4.935,00

Polipasto eléctrico ST Ex



400V, trifásico, 50Hz, botonera 48V. ATEX Zona 1. INCLUIDO: 2 velocidades de elevación + 2 velocidades de traslación [20/5 m/min], 3 metros de cadena, cuadro de maniobra, botonera 48V, bolsa guardacadenas y limitador de carga mediante embrague y protección termo-sonda en los dos motores. También disponibles con gancho de suspensión, carro manual, carro de altura super reducida, múltiples configuraciones opcionales, altos grupos de trabajo.

Ref.	Código	Ramales	Capacidad kg	Altura m	€/ u.
8000932	ST2002-8/2 Ex	2	500	3	Consultar
8000933	ST2005-12/2 Ex	2	1.000	3	Consultar
8000934	ST2008-10/1,6 Ex	2	1.600	3	Consultar
8000935	ST2010-10/1,6 Ex	2	2.000	3	Consultar
8000936	ST5016-4/1 Ex	2	3.200	3	Consultar
8000937	ST5025-4/1 Ex	2	5.000	3	Consultar



Polipasto neumático ATEX de cadena CPA con gancho superior



Recorrido 3 metros. Botonera colgante para control (2 metros=

Ref.	Código	Capacidad en Kg / Ramales	Precio por metro adicional	€/ u.
2402519	N08505001	2.000 / 1	145	11.013,17
2402520	N08505002	3.000 / 1	145	11.264,51
2402521	N08505004	5.000 / 2	290	13.130,39
2402522	192069175	6.000 / 2	290	14.198,58
2402523	N08505005	7.500 / 3	340	17.314,77
2402524	N08505006	10.000 / 4	434	32.472,92



Pinza de anclaje CORSO



Los carros con ruedas dentadas corso de accionamiento manual y de empuje se pueden montar rápida y fácilmente en una viga de acero, con una abrazadera recta e inclinada, lo que crea un punto de anclaje fiable para equipos de elevación tales como tirfor®, bravo™, tralift™, minifor™ y tralift™ TT. Es posible ajustar manualmente la apertura, de modo que el carro se puede posicionar y ajustar fácilmente. a los perfiles más utilizados. De 250kg a 20t Para anchos de viga de 45 a 320 mm según la capacidad Mango incluido para un ajuste rápido y fácil de la barra colgante para adaptarse al tamaño de la viga. Topes finales de acero plegados que también actúan como barras anticaída y dispositivos anticaída soldados a las chapas laterales. Barra de suspensión que impide la rotación apretando un tornillo de presión Ruedas de acero con cojinetes de bolas



Ref.	Código	Capacidad kg	Apertura mm	€ / u.
707700	7009	1.000	75-120	153,00
707701	7019	2.000	75-210	250,00
707702	7029	3.000	80-320	320,00
707703	7039	5.000	80-320	385,00
707704	7049	10.000	90-320	740,00

Carro portaparejos



Los carros con ruedas dentadas corso de accionamiento manual y de empuje se pueden montar rápida y fácilmente en una viga de acero, con una abrazadera recta e inclinada, lo que crea un punto de anclaje fiable para equipos de elevación tales como tirfor®, bravo™, tralift™, minifor™ y tralift™ TT. Es posible ajustar manualmente la apertura, de modo que el carro se puede posicionar y ajustar fácilmente. a los perfiles más utilizados. De 250kg a 20t Para anchos de viga de 45 a 320 mm según la capacidad Mango incluido para un ajuste rápido y fácil de la barra colgante para adaptarse al tamaño de la viga. Topes finales de acero plegados que también actúan como barras anticaída y dispositivos anticaída soldados a las chapas laterales. Barra de suspensión que impide la rotación apretando un tornillo de presión Ruedas de acero con cojinetes de bolas



Traslación manual

Ref.	Código	Carga tn	Ancho vía mm	Altura pérdida mm	Peso kg	€ / u.
708503	69289	0,250	50-220	78	3,5	158,00
708500	23309	0,5	50-220	120	8	176,00
708501	23319	1	58-220	150	14	234,00
708502	23329	2	66-220	185	22	348,00

Traslación por cadena

Ref.	Código	Carga tn	Ancho vía mm	Altura pérdida mm	Peso kg	€ / u.
708600	23339	1	58-220	150	18	459,00
708601	23349	2	66-220	185	27	660,00
708602	23359	3	74-220	210	42	840,00
708603	23369	5	90-220	218	61	1.232,00
708605	24839	20	320	270	254	1.510,00



Carro de empuje porta aparejos modelo HTP



Para instalación en perfiles, de color negro.



Ref.	Código	Capacidad en Kg.	Ancho ala de viga mm	€ / u.
2402525	N05141273	500	50 - 220	121,41
2402526	N05141274	1000	50 - 220	175,73
2402527	N05141275	2000	66 - 220	246,02

Ref.	Código	Capacidad en Kg.	Ancho ala de viga mm	€ / u.
2402528	N05141276	3000	74 - 220	418,55
2402529	N05141277	5000	90 - 220	677,34

Carro de empuje porta aparejos modelo HTG



Para instalación en perfiles, de color negro. Incluye 3 m de cadena de mando.



Ref.	Código	Capacidad en Kg.	Ancho ala de viga mm	€ / u.
2402530	N05300006	500	50 - 220	208,74
2402531	N05300007	1000	50 - 220	256,67
2402532	N05300008	2000	66 - 220	309,92
2402533	N05300009	3000	74 - 220	440,91
2402534	N05300010	5000	90 - 220	604,92
2402535	N05300016	8000	125 - 310	1.061,81

Ref.	Código	Capacidad en Kg.	Ancho ala de viga mm	€ / u.
2402536	N05300017	10000	125 - 310	1.080,97
2402537	N05300018	15000	125 - 310	2.895,74
2402538	N05300019	20000	125 - 310	3.035,25
2402539	192045613	30000	175 - 305	Consultar
2402540	192045614	50000	175 - 305	Consultar

Balancín fijo (TTS-E)



Incluye tratamiento C2 estándar para interior RAL 1021. Diseñado y fabricado de acuerdo con UNE-EN 13155. Equipado con 2 ganchos giratorios y 2 grilletes. Velocidad máxima de elevación: 16 m/ min. Para el transporte de cargas simétricas. No hay soldaduras de carga.



Ref.	Código	CMU (kg)	€ / u.
2402541	TTS-E-500KG	500	991,52
2402542	TTS-E-1000KG	1000	1.379,18
2402543	TTS-E-1500KG	1500	1.393,02
2402544	TTS-E-2000KG	200	1.501,65
2402545	TTS-E-2500KG	2500	1.610,28
2402546	TTS-E-3000KG	3000	1.667,79

Ref.	Código	CMU (kg)	€ / u.
2402547	TTS-E-4000KG	4000	1.738,08
2402548	TTS-E-5000KG	5000	1.971,32
2402549	TTS-E-6000KG	6000	2.250,34
2402550	TTS-E-8000KG	8000	2.380,28
2402551	TTS-E-10000KG	10000	2.639,07

Balancín regulable (TTS)



Incluye tratamiento C2 estándar para interior RAL 1021. Diseñado y fabricado de acuerdo con UNE-EN 13155. Equipado con 2 ganchos giratorios, 2 grilletes y guía con distintas posiciones de regulación. Velocidad máxima de elevación: 16 m/ min. Para el transporte de cargas simétricas. No hay soldaduras de carga.



Ref.	Código	CMU (kg)	€/ u.
2402552	TTS 500KG	500	1.216,23
2402553	TTS 1000KG	1000	1.610,28
2402554	TTS 1500KG	1500	1.624,13
2402555	TTS 2000KG	2000	1.727,43
2402556	TTS 2500KG	2500	1.811,57
2402557	TTS 3000KG	3000	1.874,40

Ref.	Código	CMU (kg)	€/ u.
2402558	TTS 4000KG	4000	2.083,14
2402559	TTS 5000KG	5000	2.364,30
2402560	TTS 6000KG	6000	2.668,89
2402561	TTS 8000KG	8000	2.803,08
2402562	TTS 10000KG	10000	3.259,97

Cabrestante eléctrico RPE



El cabestrante RPE en su versión estándar se suministra como componente para una aplicación determinada para arrastre o elevación. El usuario debería verificar la conformidad del cabestrante en función de la aplicación requerida antes del pedido. Rogamos averiguar si el cabestrante necesita una de las siguientes opciones: embrague de deslizamiento como p. ej. protección contra sobrecarga - limitadores de movimientos (limitadores de finales de carrera, pulsadores de cable flojo) - tambor ranurado u otros. Atención: el cable de acero se suministra por separado y debe ser instalado por el usuario.



Ref.	Código	Capacidad daN	€/ u.
2402563	NO6500141	250	3.340,91
2402564	NO6500147	500	3.412,26
2402565	NO6500274	1.000	5.431,50
2402566	NO6500274	2.000	5.431,50

Carro guía arrastre PAKROL



pakrol™ es una serie modular para desplazar y colocar al nivel de suelo cargas pesadas. El timón o brazo de guía permite tirar de la carga y orientarla, mientras que los carros guía garantizan una buena distribución de la carga en el suelo. Las distintas combinaciones posibles ofrecen un amplio margen de capacidad, desde 8 a 20 t. El suelo debe estar perfectamente plano y liso para poder desplazar la carga. Carros guía de arrastre con plataforma montada sobre rodamientos de bolas. Tanquetas de rodillos acopladas entre sí por medio de una barra de unión para repartir la carga. Tanquetas de rodillos de nylon y/o poliuretano montadas sobre rodamientos. Fabricación robusta en aleación de acero Timones (plataforma sobre corona de bolas) Altura de la tanqueta: 110 mm

Ref.	Código	Carga tn	Nº rodillos	Peso kg	€/ u.
709001	55579	4	4 Pu	14	290,00
709000	50179	4	4 Nylon	14	305,00
709002	50189	6	8 Nylon	50	870,00
709003	50199	8	8 Pu	50	1.000,00



Tanqueta / Rodillos - PAKROL



pakrol™ es una serie modular para desplazar y colocar al nivel de suelo cargas pesadas. El timón o brazo de guía permite tirar de la carga y orientarla, mientras que los carros guía garantizan una buena distribución de la carga en el suelo. Las distintas combinaciones posibles ofrecen un amplio margen de capacidad, desde 8 a 20 t. El suelo debe estar perfectamente plano y liso para poder desplazar la carga. Carros guía de arrastre con plataforma montada sobre rodamientos de bolas. Tanquetas de rodillos acopladas entre sí por medio de una barra de unión para repartir la carga. Tanquetas de rodillos de nylon y/o poliuretano montadas sobre rodamientos. Fabricación robusta en aleación de acero Timones [plataforma sobre corona de bolas] Altura de la tanqueta: 110 mm



Ref.	Código	Carga tn	N° rodillos	Peso kg	€ / u.
709101	55549	2	2 Pu	5	157,00
709103	55559	4	4 Pu	11	325,00
709105	55569	6	6 Pu	25	460,00
709100	50149	2	2 Nylon	5	136,00
709102	50159	4	4 Nylon	11	290,00
709104	50169	6	6 Nylon	25	375,00

Gato de cremallera "TOP"



Gatos de cremallera desde 1,5 hasta 10 Tn Manipulación de cargas pesadas hasta 390 mm de elevación. Robusto y sin mantenimiento, este tipo de gato se adapta completamente al lugar de trabajo. El gato mecánico top™ se acciona mediante una palanca. El ascenso se controla mediante una manivela que opera sobre la rueda dentada con un doble cierre de seguridad, proporcionando mayor seguridad al gato. El descenso se realiza mediante el movimiento inverso de la manivela, reteniendo la carga por discos de fricción. La carga puede elevarse por la cabeza del gato o por la pata de elevación. Carga de trabajo de 1,5 hasta 10 toneladas Se puede utilizar en un espacio limitado



Ref.	Código	Modelo	CMU Tm	Elevación necesaria estribo mm	Esfuerzo de palanca daN	Peso kg	Dimensiones mm A	Dimensiones mm B	Dimensiones mm C min	Dimensiones mm D min	Dimensiones mm E	Dimensiones mm F	Dimensiones mm G	Dimensiones mm H	Dimensiones mm K	Dimensiones mm R	€ / u.
709300	196478	TOP 1,5	1,5	300	30	18	81	100	600	70	55	43	110	225	147	119	280,00
709301	196488	TOP 3	3	355	35	20	83	130	735	70	60	45	138	249	158	129	350,00
709302	196498	TOP 5	5	345	40	28	108	140	735	80	71	68	170	249	190	146	435,00
709303	196508	TOP 10	10	390	58	46	124	140	800	100	85	76	170	300	250	158	798,00

Gato de cremallera ZWW Ex



Los gatos de cremallera mural de tornillo sin fin son utilizados para elevar, bajar, tirar y empujar cargas. Modelo ZWW. ATEX MEDIO II 2 GD c IIB T4

Ref.	Código	ATEX	Capacidad	€ / u.
8001002	Gato cremallera ZWW Ex / MEDIO	MEDIO	2.000 KG	Consultar



Gato de cremallera mural modelo ZWW-L



Los gatos de cremallera ZWW-L son utilizados para elevar, bajar, tirar y empujar cargas.

Ref.	Código	Capacidad Kg	Carrera mm	€/ u.
2402567	NO1905011	300	400	624,09
2402568	NO1905012	600	400	640,07
2402569	NO1905013	300	600	624,09
2402570	NO1905014	600	600	656,04
2402571	NO1905015	1200	600	946,79
2402572	NO1905016	300	800	657,11
2402573	NO1905017	600	800	686,93
2402574	NO1905018	1200	800	994,71
2402575	NO1905020	600	1.000	723,14
2402576	NO1905021	1200	1.000	1.044,77
2402577	NO1905023	600	1.200	761,48
2402578	NO1905025	1200	1.400	1.208,78



Ganchos pesadores modelos GPJM y GPJ



Ref.	Código	Capacidad kg	Peso kg	€/ u.
1308655	GPJM030	300	1.2	255,00
1308656	GPJM050	500	1.2	285,00
1308657	GPJM100	1.000	1.2	315,00
1308658	GPJ100	1.000	11	670,00
1308659	GPJ200	2.000	11	725,00
1308660	GPJ300	3.000	11	745,00
1308661	GPJ500	5.000	14.8	775,00
1308662	GPJ1000	10.000	42	1.150,00
1308663	GPJ1500	15.000	62.5	2.195,00
1308664	GPJ2000	20.000	62.5	2.285,00



Dinamómetro DYNAFOR PRO



El Dynafor Pro es la última versión de un dinamómetro digital inalámbrico versátil y robusto, que se utiliza en varias aplicaciones de medición de fuerza y pesaje

Ref.	Código	Modelo	Capacidad Tn	Precisión +/- kg	Peso kg	€/ u.
709521	293369	DYNAFOR PRO 1 T	1	0.2	0.7	1.874,00
709523	293379	DYNAFOR PRO 3,2 T	3,2	0.2	0.86	2.179,00
709524	293389	DYNAFOR PRO 6,5 T	6.5	0.2	1.6	2.522,00
709525	293399	DYNAFOR PRO 15 T	15	0.2	3.66	2.765,00
709526	293409	DYNAFOR PRO 25 T	25	0.2	5.33	3.155,00
709527	293419	DYNAFOR PRO 50 T	50	0.2	11.45	5.100,00
21124009	293429	DYNAFOR PRO 100 T	100	0.2	27.48	8.150,00



Dinamómetro DYNAFOR INDUSTRIAL



El Dynafor industrial es parte de la completa gama de dinamometría Tractel. Es la evolución natural de la gama LL22. Funciones: Tara y carga máxima. Pantalla LCD de 17,8 mm. Autonomía de 350h. Indicador estado de carga.

Ref.	Código	Modelo	Capacidad Tn	Precisión +/- kg	Incremento kg	Peso kg	€/ u.
8002894	260889	DYNAFOR INDUSTRIAL - 1	1	3	1	0,75	1.323,00
8002895	260899	DYNAFOR INDUSTRIAL - 3.2	3,2	9,6	5	0,93	1.507,00
8002896	260909	DYNAFOR INDUSTRIAL - 6.3	6,3	18,9	10	1,44	1.656,00
8002897	260919	DYNAFOR INDUSTRIAL- 12.5	12,5	37,5	20	3,22	1.961,00
8002898	260929	DYNAFOR INDUSTRIAL - 20	20	60	50	4,95	2.304,00



08

Gato hidráulico "HIDROFOR"



El hidrofor™ es un gato hidráulico monobloque con estribo de elevación. Los gatos hidráulicos hydrofor™ son ligeros en peso y permiten un fácil transporte y manejo. Con un cuerpo giratorio de 360° y un mango de accionamiento giratorio de 180°, hydrofor™ es un gato versátil. De 5000kg a 25000kg Operaciones de trabajo pesado con uno de los gatos más ligeros del mercado Funcionalidad vertical y horizontal Capacidad de elevación total en la cabeza o en los pies El dispositivo de límite de presión previene la sobrecarga para una operación segura Válvula de descarga de tornillo para un descenso fácil y controlado Giro de 360 grados para facilitar su posicionamiento El mango gira 180 grados



Ref.	Código	Modelo	CMU Tm	Pata min./max.	Cabeza min./max.	Peso kg	Dimensiones					€/ u.
							mm A	mm B	mm C+D	mm E	mm F	
709200	243269	HD-5	5	25-230	368-573	25	368-573	745	140 x 213	Ø 93	25	790,00
709201	243279	HD-10	10	30-230	420-650	35	420-650	745	170 x 205	Ø 103	30	980,00
709202	79909	HD-10	25	58-273	505-720	109	505-720	1.305	210 x 420	155 x 155	58	3.790,00

Eslinga plana



Ref. Long. 1 m	€/ u.	Ref. Long. 1,5 m	€/ u.	Carga de trabajo kg	Ancho mm	Longitud mm
709700	13,08	709800	19,85	1000	30	1
709701	27,96	709801	36,79	2000	60	1
709702	43,98	709802	56,96	3000	90	1



Ref. Long. 2 m	€/ u.	Ref. Long. 3 m	€/ u.	Ref. Long. 4 m	€/ u.	Ref. Long. 5 m	€/ u.	Ref. Long. 6 m	€/ u.	Ref. Long. 7 m	€/ u.	Ref. Long. 8 m	€/ u.	Carga de trabajo kg	Ancho mm	Longitud mm
709900	22,56	710000	29,78	710100	36,91	710200	43,98	710300	50,73	710400	58,20	710500	65,64	1000	30	5
709901	33,39	710001	45,79	710101	60,01	710201	70,61	710301	85,01	710401	112,44	710501	142,43	2000	60	5
709902	59,32	710002	73,63	710102	94,18	710202	115,02	710302	134,77	710402	168,24	710502	194,98	3000	90	5
709903	92,91	710003	122,22	710103	151,55	710203	180,77	710303	210,09	710403	239,30	710503	268,61	4000	120	5
709904	122,03	710004	158,53	710104	195,21	710204	231,73	710304	268,93	710404	304,90	710504	341,46	5000	150	5
709905	146,37	710005	195,21	710105	243,93	710205	292,72	710305	341,58	710405	390,30	710505	439,09	6000	180	5
		710006	304,90	710106	377,54	710206	450,74	710306	523,91	710406	597,11	710506	670,15	8000	240	5
		710007	390,30	710107	487,82	710207	585,47	710307	683,01	710407	780,66	710507	878,32	10000	300	5

Eslinga redonda



Ref. Long. 1 m	€/ u.	Ref. Long. 1,5 m	€/ u.	Carga de trabajo kg	Ancho/Diám. mm	Longitud mm
710700	9,83	710800	12,97	1.000	45/30	
710701	13,65	710801	23,46	2.000	50/34	1
710702	18,62	710802	27,04	3.000	60/35	1
710703	24,35	710803	34,40	4.000	70/46	1
710704	27,30			5.000	75/50	1



Ref. Long. 2 m	€/ u.	Ref. Long. 3 m	€/ u.	Ref. Long. 4 m	€/ u.	Ref. Long. 5 m	€/ u.	Ref. Long. 6 m	€/ u.	Ref. Long. 7 m	€/ u.	Ref. Long. 8 m	€/ u.	Carga de trabajo kg	Ancho/Diám. mm	Longitud mm
710900	16,61	711000	23,13	711100	29,89					711400	61,06	711500	69,42	1.000	45/30	7
710901	23,13	711001	32,81	711101	43,31	711201	53,58	711301	64,85	711401	85,86	711501	98,23	2.000	50/34	7
710902	32,16	711002	45,68	711102	59,21	711202	75,56	711302	87,40	711402	117,37	711502	133,60	3.000	60/35	7
710903	41,00	711003	59,21	711103	75,87	711203	96,42	711303	115,02	711403	145,58	711503	167,78	4.000	70/46	7
710904	54,35	711004	80,62	711104	100,37	711204	121,23	711304	145,48	711404	182,40	711504	207,74	5.000	75/50	7
710905	71,74	711005	111,08	711105	143,52	711205	176,49	711305	205,23	711405	299,93	711505	342,04	6.000	85/55	7
710906	109,96	711006	162,38	711106	215,93	711206	268,93	711306	318,01	711406	359,03	711506	409,46	8.000	95/60	7
710907	162,38	711007	244,69	711107	304,48					711407	446,40	711507	509,07	10.000	110/66	7

Sistema de trincaje



Ref.	Anchura mm	Longitud mm	C.M.U. kg	€ / u.
711600	25	5	1.500	19,26
711601	35	6	1.500	49,01
711602	50	8,50	2.500	74,83
711603	75	7	5.000	258,73



Protector de eslingas



Es un elastómero de poliuretano transparente. Es extremadamente resistente al corte y a la abrasión. El alargamiento a la rotura se sitúa en el 450% y la resistencia al desgaste progresivo en 20 N/mm.. Posee una elevada elasticidad y no envejece. Protector por dos caras. El protector debe ser más corto que la eslinga, para que tenga espacio y se pueda deslizar hacia ambos lados de la eslinga

Ref.	Código	Ancho máx. cinta	Dimensiones mm	Espesor mm	Para eslinga kgrs.	€ / u.
21021105	3BZT2030	30	50x40x10	5	1.000	97,97
21021106	3BZT2060	60	80x70x12	5	2.000	105,69
21021107	3BZT2100	90	110x100x12	5	3.000	125,20
21021108	3BZT2135	120	145x135x12	5	4.000	170,30
21021109	3BZT2160	150	170x160x12	5	5.000	182,41
21021110	3BZT2190	180	200x190x12	5	6.000	201,97
21021111	3BZT2280	250	290x280x15	8	8.000	262,62
21021112	3BZT2320	300	330x320x15	8	10.000	396,12



Gato hidráulico de botella



A: Altura mínima
B: Recorrido hidráulico
C: Recorrido extensible
D: Altura total

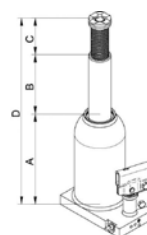

BR30

Ref.	Código	Tn	A mm	B mm	C mm	D mm	Peso kg	€ / u.
711701	BR3	3	168	105	65	338	3,7	85,00
711703	BR5	5	212	150	75	437	4,5	88,00
711705	BR10	10	219	150	75	444	6,4	105,00
711708	BR20	20	234	150	75	459	10,6	135,00

Ref.	Código	Tn	A mm	B mm	C mm	D mm	Peso kg	€ / u.
711710	BR30	30	242	150	75	467	15,7	185,00
711711	BR40	40	246	150	-	396	22,5	255,00
711712	BR50	50	260	140	-	400	27,0	325,00
711714	MGD-100	100	300	150	-	450	87,0	1.650,00

Gato de botella telescópico



A: Altura mínima C: Recorrido extensible B: Recorrido hidráulico D: Altura total

Ref.	Código	Tn	A mm	B mm	C mm	D mm	Peso kg	€ / u.
711803	BRT12	12	245	326	-	571	15,4	355,00

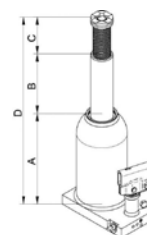

3030/2T Gato hidráulico rebajado de 2 toneladas de 6 ruedas



- Excelente maniobrabilidad del elevador sobre pavimentos irregulares
- Ruedas delanteras dobles basculantes de material plástico (PTFE)
- El pedal permite una aproximación rápida
- Capacidad: 2 toneladas
- Elevación mínima: 85 mm
- Elevación máxima: 520 mm
- Longitud: 860 mm
- Ancho: 400 mm
- Válvula de descenso controlado
- Peso: 45 kg



Ref.	Código	€/ u.
8005265	30300020	850,00

Gato de carretilla



Ref.	Código	Tn	Peso kg	€/ u.
21079000	GT2	2	35	345,00
21079001	GT3	3	35	385,00



Gato especial de botella



A: Altura mínima C: Recorrido extensible B: Recorrido hidráulico D: Altura total

Ref.	Código	Tn	A mm	B mm	C mm	D mm	Peso kg	€/ u.
711750	BR2LLC	2	570	460	-	1.030	6,0	160,00
711754	BRS10	10	131	62	30	223	5,0	135,00
711756	BRS20	20	190	105	55	350	9,5	175,00

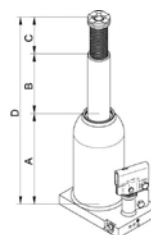

Prensa de taller

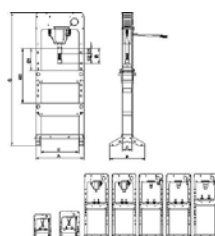

PRS15



PRD50NF

Ref.	Código	Tipo accionamiento	Fuerza T	A mm	B mm	C mm	D mm	E mm	g1 mín.	g2 máx.	R1	R2	Peso kg	€/ u.
712066	PRS15	Manual 1 velocidad	15	550	350	800	132	430	45	338	95	75	48	635,00
712060	PRB30	Manual hid. monobloc	30	670	488	1.850	132	530	53	740	150	75	104	945,00
712062	PRD50	Manual 2 velocidades	50	890	490	1.900	150	720	84	770	120	75	191	1.675,00
712063	PRD50NF	Neumático-manual	50	890	490	1.900	150	720	84	770	120	75	195	1.875,00



Grúas de taller



Ref.	Código	Capacidad kg	Peso kg	€/ u.
21079003	CRV10	1000	85	895,00

Accionamiento manual

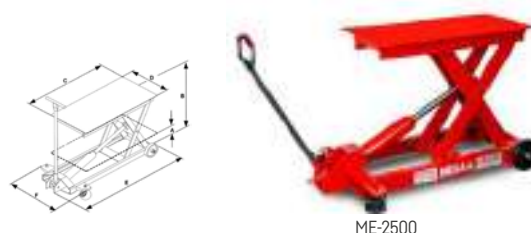

Ref.	Código	Capacidad kg	A mm	B mm	C mm	D mm	E mm	F	Peso kg	€/ u.
712303	ME-1500	1.500	210	880	1.020	500	1.380	690	135	1.575,00
712304	ME-2500	2.500	300	880	1.060	540	1.440	795	187	1.875,00

Mesa hidráulica, accionamiento eléctrico



Las mesas elevadoras de tijera con bomba hidráulica accionada con el pie son herramientas ideales para una gran variedad de operaciones de izado y carga, y para utilizar como "mesa de trabajo" con mejores condiciones ergonómicas, así como con una mayor productividad. Disponibles con capacidad nominal de 150-800 kg y tijera simple y doble para elevación de hasta 1300 mm, representan la mejor solución para manipular cargas de forma manual, combinando la funcionalidad, el ahorro de costes, la seguridad y la salud del operario durante el trabajo



HTV0100V000



HTV0300V000



HT00700V000

Ref.	Código	Carga Kg	Elevación mínima mm	Elevación máxima mm	Dimensiones mm	€/ u.
21134028	HTV0100V000	150 Kg	210	720	700x450	424,76
21134029	HTV0300V000	300 Kg	280	900	815x500	627,81
21134030	HTR0300V000	350 Kg	350	1.300	905x500	729,50
21134031	HT00700V000	800 Kg	415	1.000	1016x500	851,23

Bomba manual



Ref.	Código	Presión de trabajo kg/cm2	Capacidad aceite útil cm3	Velocidades	Peso kg	€ / u.
712600	BM-04	700	400	1	4,25	185,00
712601	BM-1	700	1.250	1	6,7	210,00
712602	BM-2	700	2.000	1	12	265,00
712604	BM-3	700	3.000	2	9,5	585,00
712606	BM-6	700	6.000	2	20	675,00



Plataforma elevadora



La serie LP12 de plataformas móviles permite operar de forma segura hasta 5 metros con una carga máxima de 120 Kg. Estas máquinas, muy ligeras gracias a su fabricación en aluminio, están equipadas con 4 ruedas pivotantes con sistema de bloqueo central. Su diseño ergonómico y tamaño reducido permiten un transporte sencillo tanto en vehículo como en el área de trabajo.

Ref.	Código	Carga kg	Altura de trabajo máxima	Dimensiones cm	€ / u.
2402579	HJ612000000	120	5.000	69 x 117 x 198	6.460,00
2402580	HJ614000000	140	5.000	77 x 125 x 151	8.240,00



Apilador manual



La serie MX además de ofrecer una excelente relación entre precio y prestaciones, es también una máquina robusta y resistente. Su alta capacidad, las poleas de acero y las horquillas guiadas por rodillo son algunas de sus principales características que demuestran su gran calidad. Además el MX está equipado con un pedal que facilita la elevación de las horquillas reduciendo el esfuerzo del operador.

Ref.	Código	Carga kg	Elevación máxima mm	Replegado	€ / u.
21134036	HB310000000	1.000	1.600	1.970	1.254,00



Apilador eléctrico



Este apilador de tamaño compacto, potente y fiable, es la solución ideal para trabajar en espacios reducidos. El mástil dúplex permite una capacidad de elevación hasta 2.900 mm. La anchura reducida (800 mm), el sistema de conducción lateral y el posicionamiento del mástil aseguran una gran maniobrabilidad, estabilidad y visibilidad. Su batería integrada y el cargador con el cable incorporado, hacen de la serie GX un apilador listo para trabajar.

Ref.	Código	Carga kg	Elevación máxima mm	Batería	Replegado mm	€ / u.
2402581	HM61200B000	1.000	1.600	2x12V/70 Ah	1.970	5.810,00



Apilador eléctrico



RX es el apilador más compacto de nuestra gama, mono mástil, completamente eléctrico, preparado para cargas de hasta 1.000 kg, permite un uso seguro y cómodo, con bajos costes de mantenimiento, gracias a su robusto diseño con fácil acceso para el mantenimiento. El RX ofrece un diseño compacto y ergonómico, que permite una amplia gama de usos en ámbitos de distribución y producción que no precisen de un uso intensivo.

Ref.	Código	Carga kg	Elevación máxima mm	Batería	Replegado mm	€ / u.
2402582	HI31000B000	1.200	2.900	2x12V/85 Ah	1.987	4.819,00



Transpaletas eléctricas



La solución eficiente para operaciones logísticas diarias de trabajo ligero. Simple y fácil de usar gracias a su tamaño compacto, peso reducido y batería de iones de litio extraíble libre de mantenimiento (Li-Ion 24V/20Ah). Puede transportar cargas de hasta 1500 kg, también en rampas.

Ref.	Código	Carga kg	Longitud mm	Ancho Total mm	Batería	€ / u.
2402583	EWQ4710001M	1.500	1.150	560	Li-Ion 24V/20 Ah	2.025,00



Transpaletas tijera manuales



La transpaleta elevadora HX10M, permite una elevación manual más fácil y ligera, hasta una altura de 800mm, convirtiéndose en un práctico soporte de trabajo, ideal para talleres mecánicos. Esta transpaleta también es capaz de llevar a cabo la función de apoyo y suministro de material a lo largo de las líneas de montaje y producción.

Ref.	Código	Carga kg	Longitud mm	Ancho Total mm	Elevación máxima mm	€ / u.
2402585	TT0420VY100	1.000	1.150	540	800	1.353,00



Transpaletas manuales



Las nuevas GS S4 Sinex aportan características mejoradas: más robustas y fáciles de usar con una ergonomía superior. Producto Europeo, fiables, robustas: las GS pueden mover hasta 2500 kg gracias a un chasis de acero capaz de soportar las aplicaciones más intensas. Versátil sin comprometer la maniobrabilidad: el nuevo diseño del timón asegura un fácil manejo en espacios reducidos y ergonomía durante el transporte de cargas

Ref.	Código	Carga kg	Longitud mm	Ancho Total mm	Tipo de rueda	€ / u.
21134032	TAB4100Y0L7	2.500	1.150	525	Nylon/Poly	290,00
21134033	G6B330UV100	2.500	1.150	555	Nylon/Poly	1.385,00



Carretilla ABS plegable negro carga



Ref.	Código	Denominación	Carga kg.	Peso kg.	€ / u.
2402586	11490001	BC-30	45	1.3	19,87
	11490002	BC-70	70	3	



Carretilla ALU plegable carga



Ref.	Código	Denominación	Carga kg.	Peso kg.	€ / u.
2402588	11490003	HT-90	90	4	68,65
2402589	11490005	HT-200	200	10	162,15



Carretilla hierro plegable carga



Ref.	Código	Denominación	Carga kg.	Peso kg.	€ / u.
2402590	11490004	HT-120	120	5.8	76,68



Serie NF Nylon fundido extrafuerte



Fabricada con acero forjado hasta 12 m/m de espesor. Acabado pintado negro. Combinación de cojinetes de bolas y cónicos en el soporte: el superior para esfuerzos axiales, y el inferior para esfuerzos radiales. Cabezal giratorio protegido, con engrasador y atornillado mediante vástago central macizo. Ruedas con rodamientos de bolas de precisión, eje macizo roscado. Fabricadas según normas europeas EN 12532.



Ref.	Código	Ø mm	Carga kg	Ancho Banda mm	Ø Agujero	Altura total mm	€/ u.
719010	2-3595	200	4.500	80	M16	290	1.276,16
719011	2-3596	250	6.000	80	M16	330	1.581,52
719012	2-3597	300	6.000	80	M16	390	1.764,74
719013	2-3598	200	4.500	80	M16	290	867,16
719014	2-3599	250	6.000	80	M16	330	1.057,08
719015	2-3600	300	6.000	80	M16	390	1.346,14
21008000	2-4254	200	4.500	80	M16	290	1.577,29
21008001	2-4255	250	6.000	80	M16	330	1.887,11
21008002	2-4256	300	6.000	80	M16	390	2.076,38
21008003	2-4249	200	4.500	80	M16	290	1.458,13
21008004	2-4250	250	6.000	80	M16	330	1.767,93
21008005	2-4251	300	6.000	80	M16	390	1.957,22
719016	2-3601	200	4.500	80	45 mm	200	414,18
719017	2-3602	250	6.000	80	50 mm	250	592,75
719018	2-3603	300	6.000	80	50 mm	300	824,78

Serie HU Poliuretano fundido



Fabricada con acero forjado hasta 12 m/m de espesor. Acabado pintado negro. Combinación de cojinetes de bolas y cónicos en el soporte: el superior para esfuerzos axiales, y el inferior para esfuerzos radiales. Cabezal giratorio protegido, con engrasador y atornillado mediante vástago central macizo. Ruedas con rodamientos de bolas de precisión, eje macizo roscado. Fabricadas según normas europeas EN 12532.



Ref.	Código	Ø mm	Carga kg	Ancho Banda mm	Ø Agujero	Altura total mm	€/ u.
719020	2-3590	250	3.200	75x2	M16	330	1.269,19
719021	2-3591	300	4.000	75x2	M16	390	1.358,24
719022	2-3593	250	3.200	75x2	M16	330	828,92
719023	2-3594	300	4.000	75x2	M16	390	912,72
21008006	2-4257	250	3.200	75x2	M16	330	1.835,50
21008007	2-4258	300	4.000	75x2	M16	390	2.017,07
21008008	2-4252	250	3.200	75x2	M16	330	1.716,32
21008009	2-4253	300	4.000	75x2	M16	390	1.897,89
719024	2-3437	250	1.600	75	25mm	250	328,99
719025	2-3438	300	2.000	75	25mm	300	390,53



Serie HLG con núcleo de acero y banda de poliuretano

Fabricada con chapa de acero soldado hasta 8 m/m de espesor. Cabezal giratorio con engrasador mediante dos cojinetes tratados opuestos: el superior para esfuerzos axiales, y el inferior para esfuerzos radiales. Modelo diseñado especialmente para: Puentes grúa, aviación, ejercito, puertos, etc. Acabado pintado negro. Fabricadas según normas europeas EN 12532/12533.

Ref.	Código	Ø mm	Carga kg	Tipo cojinete	Ancho Banda mm	Ø Agujero mm	€ / u.
713400	2-1746	100	350	Bolas	40	20	64,19
713401	2-1747	125	400	Bolas	40	20	77,25
713402	2-1748	150	800	Bolas	50	20	97,99
713403	2-1749	200	1.100	Bolas	50	20	117,06
713404	2-1750	250	1.250	Bolas	50	25	167,92
713406	2-3437	250	1.600	Bolas	75	25	328,99
713405	4-0546	300	1.400	Bolas	50	25	266,55



A - Rueda con Pletina giratoria



B - Rueda con Pletina fija

Ref.	Código	€ / u.	Ref.	Código	€ / u.	Ø mm	Carga kg	Ancho Banda mm	Tipo cojinete	Ø Agujero	Altura total mm
713200	2-1865	484,03	713300	2-1868	307,52	150	1.600	50 x 2	Bolas	M12	225
713201	2-1866	546,33	713301	2-1869	381,15	200	2.000	50 x 2	Bolas	M12	270
713202	2-1867	696,06	713302	2-1870	538,29	250	2.500	50 x 2	Bolas	M12	325



C - Rueda con Pletina giratoria y freno doble



D - Rueda con Pletina giratoria y bloqueo direccional

Ref.	Código	€ / u.	Ref.	Código	€ / u.	Ø mm	Carga kg	Ancho Banda mm	Tipo cojinete	Ø Agujero	Altura total mm
8002216	2-3810	567,40	8002219	2-3828	628,41	150	1.600	50 x 2	Bolas	M12	225
8002217	2-3811	629,71	8002220	2-3829	690,71	200	2.200	50 x 2	Bolas	M12	270
8002218	2-3812	738,79	8002221	2-3830	799,78	250	2.500	50 x 2	Bolas	M12	325

Serie HLG con rueda de nylon extrafuerte



Fabricada con chapa de acero soldado hasta 8 m/m de espesor. Cabezal giratorio con engrasador mediante dos cojinetes tratados opuestos: el superior para esfuerzos axiales, y el inferior para esfuerzos radiales. Modelo diseñado especialmente para: Puentes grúa, aviación, ejército, puertos, etc. Acabado pintado negro. Fabricadas según normas europeas EN 12532/12533.

Ref.	Código	Ø mm	Carga kg	Tipo cojinete	Ancho Banda mm	Ø Agujero mm	Altura total mm	€/ u.
714412	4-0012	150	900	Bolas	45	25	250	44,35
714413	4-0016	200	1.000	Bolas	50	25	300	60,50



2-1872



2-1878

Ref.	Código	€/ u.	Ref.	Código	€/ u.	Ø mm	Carga kg	Ancho Banda mm	Tipo cojinete	Ø Agujero	Altura total mm
714108	2-1872	383,88	714208	2-1878	182,99	150	1.800	45 x 2	Bolas	M12	225
714106	2-1874	416,28	714206	2-1880	228,19	200	2.000	50 x 2	Bolas	M12	270
714107	2-1876	504,39	714207	2-1882	361,46	250	2.400	57 x 2	Bolas	M12	325



2-3816



2-3834

Ref.	Código	€/ u.	Ref.	Código	€/ u.	Ø mm	Carga kg	Ancho Banda mm	Tipo cojinete	Ø Agujero	Altura total mm
8002231	2-3816	467,25	8002234	2-3834	528,24	150	1.800	45 x 2	Bolas	M12	225
8002232	2-3817	499,65	8002235	2-3835	560,65	200	2.000	50 x 2	Bolas	M12	270
8002233	2-3818	587,79	8002236	2-3836	648,78	250	2.400	57 x 2	Bolas	M12	325



Serie HLB con núcleo de acero y banda de poliuretano

Fabricada con acero soldado hasta 8 m/m de espesor. Doble cabezal giratorio, el superior de bolas grandes de acero y el inferior de precisión que facilita los esfuerzos de giro, radiales y axiales. Modelo construido especialmente para: carretillas grandes con empuje mecánico, manutención de factorías, industrias metalúrgicas, químicas, servicios públicos. Acabado cincado pintado negro. Fabricadas según normas europeas EN 12532/12533

Ref.	Código	€ / u.	Ø mm	Carga kg	Ancho Banda mm	Tipo cojinete	Ø Agujero	Altura total mm
714002	2-1761	268,49	150	800	50	Bolas	M10	200
714003	2-1762	306,34	200	1.100	50	Bolas	M10	249
714006	2-2296	360,72	250	1.100	50	Bolas	M10	315
714004	2-1763	388,02	250	1.250	50	Bolas	M16	315
8000325	2-3742	541,37	250	1.500	75	Bolas	M16	315
8000326	2-1538	464,86	300	1.270	50	Bolas	M16	360
8000327	2-3743	585,26	300	1.900	75	Bolas	M16	360



2-1751



2-1756



2-1761

Ref.	Código	€ / u.	Ref.	Código	€ / u.	Ø mm	Carga kg	Ancho Banda mm	Tipo cojinete	Ø Agujero	Altura total mm
713800	2-1751	191,43	713900	2-1756	101,73	100	350	40	Bolas	M10	160
713801	2-1752	207,29	713901	2-1757	110,42	125	400	40	Bolas	M10	183
713802	2-1753	224,14	713902	2-1758	132,33	150	800	50	Bolas	M10	200
713803	2-1754	255,40	713903	2-1759	165,86	200	1.100	50	Bolas	M10	249
713806	2-2294	309,18	713906	2-2295	202,80	250	1.100	50	Bolas	M10	315
713804	2-1755	333,61	713904	2-1760	214,30	250	1.250	50	Bolas	M16	315
713807	2-3431	514,92	713907	2-3433	428,44	250	1.500	75	Bolas	M16	315
713805	4-1230	406,17	713905	4-1231	282,53	300	1.270	50	Bolas	M16	360

Serie HLB con núcleo de acero y banda de poliuretano. Rueda con pletina giratoria y bloqueo direccional



Fabricada con acero soldado hasta 8 m/m de espesor. Doble cabezal giratorio, el superior de bolas grandes de acero y el inferior de precisión que facilita los esfuerzos de giro, radiales y axiales. Modelo construido especialmente para: carretillas grandes con empuje mecánico, manutención de factorías, industrias metalúrgicas, químicas, servicios públicos. Acabado cincado pintado negro. Fabricadas según normas europeas EN 12532/12533

Ref.	Código	Ø mm	Carga kg	Ancho Banda mm	Tipo cojinete	Ø Agujero	Altura total mm	€ / u.
8002222	2-3367	100	350	40	Bolas	M10	160	260,13
8002223	2-3368	125	400	40	Bolas	M10	183	275,98
8002224	2-3369	150	800	50	Bolas	M10	200	292,85
8002225	2-3370	200	1.100	50	Bolas	M10	249	324,11
8002226	2-3371	250	1.100	50	Bolas	M10	315	377,91
8002227	2-3372	250	1.250	50	Bolas	M16	315	402,32
8002228	2-3546	250	1.500	75	Bolas	M16	315	583,64
8002229	2-3373	300	1.270	50	Bolas	M16	360	474,88
8002230	2-3547	300	1.900	75	Bolas	M16	360	623,35



Serie HLB con núcleo de acero y banda de poliuretano en forma balona



Fabricada con acero soldado hasta 8 m/m de espesor. Doble cabezal giratorio, el superior de bolas grandes de acero y el inferior de precisión que facilita los esfuerzos de giro, radiales y axiales. Modelo construido especialmente para: carretillas grandes con empuje mecánico, manutención de factorías, industrias metalúrgicas, químicas, servicios públicos. Acabado cincado pintado negro. Fabricadas según normas europeas EN 12532/12533



2-3534



2-3536

Ref.	Código	€/u.	Ref.	Código	€/u.	Ø mm	Carga kg	Ancho Banda mm	Tipo cojinete	Ø Agujero mm	Altura total mm
8002243	2-3534	251,33	8002245	2-3536	159,57	150	600	50	Bolas	10	200
8002244	2-3535	296,91	8002246	2-3537	207,41	200	800	50	Bolas	10	249



2-3538



2-3540

Ref.	Código	€/u.	Ref.	Código	€/u.	Ø mm	Carga kg	Ancho Banda mm	Tipo cojinete	Ø Agujero mm	Altura total mm
8002247	2-3538	295,71	8002249	2-3540	320,04	150	600	50	Bolas	10	200
8002248	2-3539	341,29	8002250	2-3541	365,63	200	800	50	Bolas	10	249

Recambio rueda HUAB forma balona.



Ref.	Código	Ø mm	Carga kg	Ancho Banda mm	Tipo cojinete	Ø Agujero mm	€/u.
8002251	2-3313	150	600	50	Bolas	20	125,18
8002252	2-3314	200	800	50	Bolas	20	158,59





Serie HLB con rueda de nylon fundido extrafuerte.

Fabricada con acero soldado hasta 8 m/m de espesor. Doble cabezal giratorio, el superior de bolas grandes de acero y el inferior de precisión que facilita los esfuerzos de giro, radiales y axiales. Modelo construido especialmente para: carretillas grandes con empuje mecánico, manutención de factorías, industrias metalúrgicas, químicas, servicios públicos. Acabado cincado pintado negro. Fabricadas según normas europeas EN 12532/12533

Ref.	Código	Ø mm	Carga kg	Ancho Banda mm	Diámetro agujero	Color	€ / u.
21008022	2-4357	100	1.250	55	25	Blanco	88,38
21008023	2-4358	125	1.400	55	25	Blanco	131,86
21008024	2-4359	150	2.750	80	35	Blanco	234,07
21008025	2-3601	200	4.500	80	45	Blanco	414,18
21008026	2-3602	250	6.000	80	50	Blanco	592,75
21008027	2-3603	300	6.000	80	50	Blanco	824,78



2-4418



2-4419



2-4420



2-4487

Ref.	Código	€ / u.	Ref.	Código	€ / u.	Ref.	Código	€ / u.	Ref.	Código	€ / u.	Ø mm	Carga kg	Ancho Banda mm	Tipo cojinete	Ø Agujero mm	Altura total mm
21008013	2-4419	137,04	21008016	2-4420	296,10	21008019	2-4487	320,47	21008010	2-4418	239,96	100	1.250	55	Bolas	10	160
21008014	2-4422	181,88	21008017	2-4423	351,55	21008020	2-4488	375,91	21008011	2-4421	283,10	125	1.350	55	Bolas	10	183
21008015	2-4425	313,34	21008018	2-4426	507,66	21008021	2-4489	532,01	21008012	2-4424	452,54	150	2.750	80	Bolas	10	200

Serie HLB con rueda de nylon extrafuerte



Fabricada con acero soldado hasta 8 m/m de espesor. Doble cabezal giratorio, el superior de bolas grandes de acero y el inferior de precisión que facilita los esfuerzos de giro, radiales y axiales. Modelo construido especialmente para: carretillas grandes con empuje mecánico, manutención de factorías, industrias metalúrgicas, químicas, servicios públicos. Acabado cincado pintado negro. Fabricadas según normas europeas EN 12532/12533

Ref.	Código	Ø mm	Carga kg	Tipo cojinete	Ancho Banda mm	Ø Agujero mm	€ / u.
714400	4-0005	100	350	Bolas	32	17	21,30
714401	4-0008	125	500	Bolas	42	17	29,37
714402	4-0011	150	900	Bolas	42	20	43,61
714403	4-0015	200	1.000	Bolas	42	20	56,23
714404	4-0018	250	1.250	Bolas	57	25	101,73



2-0464



2-0473



2-1514

Ref.	Código	€ / u.	Ref.	Código	€ / u.	Ref.	Código	€ / u.	Ø mm	Carga kg	Ancho Banda mm	Tipo cojinete	Ø Agujero	Altura total mm
714100	2-0464	161,33	714200	2-0473	70,40				100	400	32	Bolas	M10	160
714101	2-0466	170,02	714201	2-0475	89,24				125	600	42	Bolas	M10	183
714102	2-0468	181,17	714202	2-0477	108,61	714300	2-1514	225,52	150	900	45	Bolas	M10	200
714103	2-0470	194,40	714203	2-0479	127,15	714301	2-1519	238,77	200	1.000	50	Bolas	M10	249
714104	2-2298	234,34				714303	2-2302	278,71	250	1.250	57	Bolas	M16	315
714105	4-1056	249,70	714205	4-1065	152,74	714302	2-1521	294,09	250	1.100	57	Bolas	M10	315



Serie HLB con rueda de nylon extrafuerte. Rueda con pletina giratoria y bloqueo direccional



Fabricada con chapa de acero soldado hasta 8 m/m de espesor. Cabezal giratorio con engrasador mediante dos cojinetes tratados opuestos: el superior para esfuerzos axiales, y el inferior para esfuerzos radiales. Modelo diseñado especialmente para: Puentes grúa, aviación, ejercito, puertos, etc. Acabado pintado negro. Fabricadas según normas europeas EN 12532/12533.



Ref.	Código	Ø mm	Carga kg	Ancho Banda mm	Tipo cojinete	Ø Agujero	Altura total mm	€ / u.
8002237	2-3376	100	400	32	Bolas	M10	160	230,06
8002238	2-3378	125	600	42	Bolas	M10	183	238,71
8002239	2-3380	150	900	45	Bolas	M10	200	249,89
8002240	2-3382	200	1.000	50	Bolas	M10	249	263,13
8002241	2-3384	250	1.100	57	Bolas	M10	315	303,06
8002242	2-3386	250	1.250	57	Bolas	M16	315	318,41

Serie TV con núcleo de nylon y banda de goma



Fabricada con chapa de acero embutido hasta 5m/m de espesor. Doble rodamiento a bolas reforzado con platillos intermedios y pistas de rodadura endurecidas. Protector anti-polvo en el cojinete del soporte. Modelo diseñado especialmente para: Carretillas industriales, mantenimiento de factorías, contenedores de trabajos duros, industrias metalúrgicas, químicas, servicios públicos, etc. Acabado cincado brillante. Fabricadas según normas europeas EN 12532.

Ref.	Código	Ø mm	Carga kg	Tipo cojinete	Ancho Banda mm	Ø Agujero mm	€ / u.
714805	2-1226	80	110	Rodillos	35	12	12,08
714806	2-1251	100	130	Rodillos	35	12	14,76
714807	2-0785	125	200	Bolas	44	17	22,75
714808	2-0786	150	280	Bolas	50	20	27,54



2-1254



2-1256



2-1607

Ref.	Código	€ / u.	Ref.	Código	€ / u.	Ref.	Código	€ / u.	Ø mm	Carga kg	Ancho Banda mm	Tipo cojinete	Ø Agujero	Altura total mm
714505	2-1254	27,91	714605	2-1256	20,24	714705	2-1607	42,35	80	110	35	Rodillos	M8	124
714506	2-1255	34,04	714606	2-1257	24,17	714706	2-1609	48,51	100	130	35	Rodillos	M8	140
714507	2-0533	48,62	714607	2-0537	34,77	714707	2-1611	69,54	125	200	44	Bolas	M10	164
714508	2-0535	59,62	714608	2-0539	42,34	714708	2-1632	80,60	150	280	50	Bolas	M10	188



Serie TV con núcleo de nylon y banda de poliuretano

Fabricada con chapa de acero embutido hasta 5m/m de espesor. Doble rodamiento a bolas reforzado con platillos intermedios y pistas de rodadura endurecidas. Protector anti-polvo en el cojinete del soporte. Modelo diseñado especialmente para: Carretillas industriales, mantenimiento de factorías, contenedores de trabajos duros, industrias metalúrgicas, químicas, servicios públicos, etc. Acabado cincado brillante. Fabricadas según normas europeas EN 12532.

Ref.	Código	Ø mm	Carga kg	Tipo cojinete	Ancho Banda mm	Ø Agujero mm	€ / u.
715204	4-0479	100	200	Bolas	33	17	28,28
715205	4-0481	125	300	Bolas	42	17	33,03
715206	4-0484	150	450	Bolas	42	20	53,01
715207	4-0488	200	600	Bolas	50	20	75,33



2-0311



2-0312



2-1613

Ref.	Código	€ / u.	Ref.	Código	€ / u.	Ref.	Código	€ / u.	Ø mm	Carga kg	Ancho Banda mm	Tipo cojinete	Ø Agujero	Altura total mm
714904	2-0311	43,59	715004	2-0312	33,70	715104	2-1613	62,08	100	200	33	Bolas	M8	140
714905	2-0313	58,76	715005	2-0314	44,89	715105	2-1615	81,35	125	300	42	Bolas	M10	164
714906	2-0315	77,81	715006	2-0316	60,85	715106	2-1634	104,02	150	450	42	Bolas	M10	188
714907	2-0317	98,01	715007	2-0318	80,88	715107	2-0967	125,47	200	600	50	Bolas	M10	251

Serie TV con rueda de nylon



Fabricada con chapa de acero embutido hasta 5m/m de espesor. Doble rodamiento a bolas reforzado con platillos intermedios y pistas de rodadura endurecidas. Protector anti-polvo en el cojinete del soporte. Modelo diseñado especialmente para: Carretillas industriales, mantenimiento de factorías, contenedores de trabajos duros, industrias metalúrgicas, químicas, servicios públicos, etc. Acabado cincado brillante. Fabricadas según normas europeas EN 12532.

Ref.	Código	Ø mm	Carga kg	Tipo cojinete	Ancho Banda mm	Ø Agujero mm	€ / u.
714405	2-0159	80	250	Rodillos	35	12	7,79
714406	2-0160	100	300	Rodillos	35	12	10,55
714407	2-0163	125	350	Bolas	45	17	28,77
714408	2-0164	150	650	Bolas	45	17	32,93
714409	2-0165	200	750	Bolas	50	20	43,12



2-0211



2-0212



2-1617

Ref.	Código	€ / u.	Ref.	Código	€ / u.	Ref.	Código	€ / u.	Ø mm	Carga kg	Ancho Banda mm	Tipo cojinete	Ø Agujero	Altura total mm
715305	2-0211	23,92	715405	2-0212	15,19	715505	2-1617	38,21	80	250	35	Rodillos	M8	124
715306	2-0213	28,84	715406	2-0214	19,01	715506	2-1619	43,96	100	300	35	Rodillos	M8	140
715307	2-0215	51,49	715407	2-0216	38,57	715507	2-1621	74,96	125	350	45	Bolas	M10	164
715308	2-0217	62,53	715408	2-0218	45,61	715508	2-1636	82,99	150	500	45	Bolas	M10	188
715309	2-0219	84,50	715409	2-0220	58,68	715509	2-0948	108,87	200	600	50	Bolas	M10	251

Serie ZVR chapa reforzada con núcleo de acero y banda de poliuretano en forma balona



Fabricada con chapa de acero embutido de hasta 4mm de espesor. Doble rodamiento a bolas con pistas de rodadura edurecidas. Protector anti-polvo en el cojinete del soporte con engrasador. Fabricadas según normas europeas EN 12532/12547



2-3857



2-3858

Ref.	Código	€/ u.	Ref.	Código	€/ u.	Ø mm	Carga kg	Ancho Banda mm	Tipo cojinete	Ø Agujero mm	Altura total mm
8002275	2-3858	119,17	8002273	2-3857	133,59	150	600	50	Bolas	10	198
8002276	2-3862	152,90	8002274	2-3861	164,84	200	700	50	Bolas	10	244



2-3859



2-3860

Ref.	Código	€/ u.	Ref.	Código	€/ u.	Ø mm	Carga kg	Ancho Banda mm	Tipo cojinete	Ø Agujero mm	Altura total mm
8002277	2-3859	148,64	8002279	2-3860	150,14	150	600	50	Bolas	10	198
8002278	2-3863	188,53	8002280	2-3864	190,98	200	700	50	Bolas	10	244

Recambio rueda HUAB forma balona.



Ref.	Código	Ø mm	Carga kg	Ancho Banda mm	Tipo cojinete	Ø Agujero mm	€/ u.
8002281	2-3313	150	600	50	Bolas	20	125,18
8002282	2-3314	200	800	50	Bolas	20	158,59





Serie ZVR reforzada con rueda AUB aluminio y poliuretano

Fabricada con chapa de acero embutido de hasta 4mm de espesor. Doble rodamiento a bolas con pistas de rodadura endurecidas. Protector anti-polvo en el cojinete del soporte con engrasador. Fabricadas según normas europeas EN 12532/12533



2-3849

Ref.	Código	Ø mm	Carga kg	Ancho Banda mm	Tipo cojinete	Ø Agujero mm	Altura total mm	€/ u.
8002253	2-3849	160	600	50	Bolas	10	203	93,20
8002254	2-3853	200	700	50	Bolas	10	244	121,14



2-3850

Ref.	Código	Ø mm	Carga kg	Ancho Banda mm	Tipo cojinete	Ø Agujero mm	Altura total mm	€/ u.
8002255	2-3850	160	600	50	Bolas	10	203	80,29
8002256	2-3854	200	700	50	Bolas	10	244	106,82



2-3851

Ref.	Código	Ø mm	Carga kg	Ancho Banda mm	Tipo cojinete	Ø Agujero mm	Altura total mm	€/ u.
8002257	2-3851	160	600	50	Bolas	10	203	108,24
8002258	2-3855	200	600	50	Bolas	10	244	135,12



2-3852

Ref.	Código	Ø mm	Carga kg	Ancho Banda mm	Tipo cojinete	Ø Agujero mm	Altura total mm	€/ u.
8002259	2-3852	160	600	50	Bolas	10	203	110,85
8002260	2-3856	200	700	50	Bolas	10	244	138,56

Recambio rueda AUB aluminio poliuretano bolas



Ref.	Código	Ø mm	Carga kg	Ancho Banda mm	Tipo cojinete	Ø Agujero mm	€ / u.
8002261	2-2548	160	600	50	Bolas	20	75,33
8002262	2-2549	200	800	50	Bolas	20	94,15



Serie ZVR reforzada con rueda AUGB aluminio y poliuretano verde elástico



Fabricada con chapa de acero embutido de hasta 4mm de espesor. Doble rodamiento a bolas con pistas de rodadura endurecidas. Protector anti-polvo en el cojinete del soporte con engrasador. Fabricadas según normas europeas EN 12532/12540



2-3920



2-3921



2-3922



2-3923

Ref.	Código	€ / u.	Ref.	Código	€ / u.	Ref.	Código	€ / u.	Ref.	Código	€ / u.	Ø mm	Carga kg	Ancho Banda mm	Tipo cojinete	Ø Agujero mm	Altura total mm
8002263	2-3920	109,05	8002265	2-3921	91,85	8002267	2-3922	129,88	8002269	2-3923	131,12	160	550	50	Bolas	10	203
8002264	2-3845	124,23	8002266	2-3846	110,01	8002268	2-3847	142,15	8002270	2-3848	142,90	200	700	50	Bolas	10	244

Recambio rueda AUGB aluminio poliuretano verde elástico bolas



Ref.	Código	Ø mm	Carga kg	Ancho Banda mm	Tipo cojinete	Ø Agujero mm	€ / u.
8002271	4-1654	160	550	50	Bolas	20	83,76
8002272	4-1641	200	700	50	Bolas	20	97,74



Serie ZVR reforzada con rueda FT nylon bolas



Fabricada con chapa de acero embutido de hasta 4mm de espesor. Doble rodamiento a bolas con pistas de rodadura edurecidas. Protector anti-polvo en el cojinete del soporte con engrasador. Fabricadas según normas europeas EN 12532/12547



2-3881



2-3882

Ref.	Código	€ / u.	Ref.	Código	€ / u.	Ø mm	Carga kg	Ancho Banda mm	Tipo cojinete	Ø Agujero mm	Altura total mm
8002285	2-3882	50,28	8002283	2-3881	67,29	150	650	42	Bolas	10	198
8002286	2-3886	64,78	8002284	2-3885	85,49	200	700	42	Bolas	10	244



2-3883



2-3884

Ref.	Código	€ / u.	Ref.	Código	€ / u.	Ø mm	Carga kg	Ancho Banda mm	Tipo cojinete	Ø Agujero mm	Altura total mm
8002289	2-3884	91,46	8002287	2-3883	88,86	150	650	42	Bolas	10	198
8002290	2-3888	109,56	8002288	2-3887	106,99	200	700	42	Bolas	10	244

Recambio rueda de nylon bolas reforzada



Ref.	Código	Ø mm	Carga kg	Ancho Banda mm	Tipo cojinete	Ø Agujero mm	€ / u.
8002291	4-0011	150	900	42	Bolas	20	43,61
8002292	4-0015	200	1.000	42	Bolas	20	56,23



Serie ZV con núcleo de aluminio y banda de goma elástica gris



Cabezal giratorio construido con doble hilera de bolas endurecidas. Fabricada con chapa de acero hasta 4mm de espesor. Modelo de uso universal para cargas medias. Especialmente diseñado para transporte industrial. Acabado cincado brillante. Fabricadas según normas europea EN12530/12532.

Ref.	Código	Ø mm	Carga kg	Tipo cojinete	Ancho Banda mm	Ø Agujero mm	€/ u.
21008036	4-1667	160	350	Bolas	50	20	54,66
21008037	4-1668	200	450	Bolas	50	20	63,18



2-4360



2-4361



2-4362



2-4365

Ref.	Código	€/ u.	Ref.	Código	€/ u.	Ref.	Código	€/ u.	Ref.	Código	€/ u.	Ø mm	Carga kg	Ancho Banda mm	Tipo cojinete	Ø Agujero mm	Altura total mm
21008030	2-4361	66,92	21008034	2-4365	88,63	21008032	2-4362	88,45	21008028	2-4360	75,20	160	350	50	Bolas	M12	201
21008031	2-4367	79,30	21008035	2-4371	99,63	21008033	2-4368	101,05	21008029	2-4366	86,21	200	400	50	Bolas	M12	242

Serie ZV con núcleo metálico y banda de goma



Cabezal giratorio construido con doble hilera de bolas endurecidas. Fabricada con chapa de acero hasta 4mm de espesor. Modelo de uso universal para cargas medias. Especialmente diseñado para transporte industrial. Acabado cincado brillante. Fabricadas según normas europea EN12530/12532.

Ref.	Código	Ø mm	Carga kg	Tipo cojinete	Ancho Banda mm	Ø Agujero mm	€/ u.
716005	2-0411	80	80	Rodillos	27	15	8,55
716006	2-0412	100	110	Rodillos	27	15	8,83
716007	4-0743	125	140	Rodillos	35	15	11,41
716008	4-0744	160	180	Rodillos	37	20	16,27
716009	4-0745	200	230	Rodillos	46	20	19,02
716010	4-0752	250	250	Rodillos	50	20	34,73



2-0323



2-0224



2-2309

Ref.	Código	€/ u.	Ref.	Código	€/ u.	Ref.	Código	€/ u.	Ø mm	Carga kg	Ancho Banda mm	Tipo cojinete	Ø Agujero	Altura total mm
715806	2-0224	14,68	715706	2-0223	18,11	715906	2-2309	27,02	80	80	27	Rodillos	M8	110
715807	2-0226	16,24	715707	2-1000	18,58	715907	2-1149	28,78	100	110	27	Rodillos	M8	131
715808	2-1003	15,16	715708	2-0225	21,01	715908	2-1908	27,47	100L	110	27	Rodillos	M8	131
715809	2-0228	22,50	715709	2-0227	29,73	715909	2-1150	37,47	125	140	35	Rodillos	M8	155
715810	2-0232	29,40	715710	2-0231	37,58	715910	2-0952	50,65	160	180	37	Rodillos	M10	201
715811	2-0234	36,83	715711	2-0233	43,61	715911	2-0955	59,09	200	230	46	Rodillos	M10	238
715812	2-0248	60,48	715712	2-0245	77,46	715911	2-0955	84,91	250	250	50	Rodillos	M12	291

Serie ZV con rueda PGR goma gris rodillos elástica antihuella con platina fija



Cabezal giratorio construido con doble hilera de bolas endurecidas. Fabricada con chapa de acero hasta 4mm de espesor. Modelo de uso universal para cargas medias. Especialmente diseñado para transporte industrial. Acabado cincado brillante. Fabricadas según normas europea EN12530/12532.



2-3751



2-3752

Ref.	Código	€ / u.	Ref.	Código	€ / u.	Ø mm	Carga kg	Ancho Banda mm	Tipo cojinete	Ø Agujero mm	Altura total mm
8002293	2-3751	20,53	8002298	2-3752	17,91	80	120	34	Rodillos	8	110
8002294	2-3756	23,02	8002299	2-3758	20,64	100	150	34	Rodillos	8	131
8002295	2-3766	30,29	8002300	2-3767	24,99	125	225	34	Rodillos	8	155
8002296	2-3771	58,63	8002301	2-3772	47,13	160	300	45	Rodillos	10	205
8002297	2-3777	72,94	8002302	2-3778	61,18	200	400	45	Rodillos	10	242

Serie ZV con rueda PGR goma gris rodillos elástica antihuella con platina giratoria



Cabezal giratorio construido con doble hilera de bolas endurecidas. Fabricada con chapa de acero hasta 4mm de espesor. Modelo de uso universal para cargas medias. Especialmente diseñado para transporte industrial. Acabado cincado brillante. Fabricadas según normas europea EN12530/12532.



2-3753



2-3776

Ref.	Código	€ / u.	Ref.	Código	€ / u.	Ø mm	Carga kg	Ancho Banda mm	Tipo cojinete	Ø Agujero mm	Altura total mm
8002303	2-3753	28,79				80	120	34	Rodillos	8	110
8002304	2-3760	30,32				100	150	34	Rodillos	8	131
8002305	2-3768	48,71				125	225	34	Rodillos	8	155
8002306	2-3773	73,41	8002308	2-3776	72,35	160	300	45	Rodillos	10	205
8002307	2-3779	91,58	8002309	2-3782	86,68	200	400	45	Rodillos	10	242

Rueda recambio PGR goma gris elástica rodillos antihuella



Ref.	Código	Ø mm	Carga kg	Ancho Banda mm	Tipo cojinete	Ø Agujero mm	€ / u.
8002310	2-3746	80	120	34	Rodillos	12	9,09
8002311	2-3747	100	150	34	Rodillos	12	10,57
8002312	2-3748	125	225	34	Rodillos	12	14,00
8002313	2-3749	160	300	45	Rodillos	20	24,75
8002314	2-3750	200	400	45	Rodillos	20	38,25



Serie ZV con rueda PGZ goma gris termoplástica antihuella



Cabezal giratorio construido con doble hilera de bolas endurecidas. Fabricada con chapa de acero hasta 4mm de espesor. Modelo de uso universal para cargas medias. Especialmente diseñado para transporte industrial. Acabado cincado brillante. Fabricadas según normas europea EN12530/12532.



2-3210



2-3220

Ref.	Código	€/ u.	Ref.	Código	€/ u.	Ø mm	Carga kg	Ancho Banda mm	Tipo cojinete	Ø Agujero mm	Altura total mm
8002315	2-3210	15,04	8002320	2-3220	12,44	80	80	28	Liso	8	110
8002316	2-3212	16,89	8002321	2-3222	14,17	100	90	30	Liso	8	131
8002317	2-3216	19,39	8002322	2-3226	16,05	125	130	32	Liso	8	155
8002318	2-3218	36,31	8002323	2-3228	31,43	160	160	38	Liso	10	205
8002319	2-3219	42,85	8002324	2-3229	35,43	200	180	45	Liso	10	242



2-3230

Ref.	Código	Ø mm	Carga kg	Ancho Banda mm	Tipo cojinete	Ø Agujero mm	Altura total mm	€/ u.
8002325	2-3230	80	80	28	Liso	8	110	22,69
8002326	2-3232	100	90	30	Liso	8	131	25,07
8002327	2-3236	125	130	32	Liso	8	155	27,97
8002328	2-3238	160	160	38	Liso	10	205	47,98
8002329	2-3239	200	180	45	Liso	10	242	54,38



2-3435

Ref.	Código	Ø mm	Carga kg	Ancho Banda mm	Tipo cojinete	Ø Agujero mm	Altura total mm	€/ u.
8002330	2-3435	160	160	38	Liso	10	205	49,62
8002331	2-3436	200	180	45	Liso	10	242	56,17

Serie ZV con núcleo de aluminio y banda de poliuretano verde con forma balona.

Cabezal giratorio construido con doble hilera de bolas endurecidas. Fabricada con chapa de acero hasta 4mm de espesor. Modelo de uso universal para cargas medias. Especialmente diseñado para transporte industrial. Acabado cincado brillante. Fabricadas según normas europea EN12530/12532.

Ref.	Código	Ø mm	Carga kg	Tipo cojinete	Ancho Banda mm	Ø Agujero mm	€ / u.
21008046	4-1661	160	500	Bolas	50	20	87,54
21008047	4-1662	200	650	Bolas	50	20	104,03



2-4388



2-4395



2-4390



2-4391

Ref.	Código	€ / u.	Ref.	Código	€ / u.	Ref.	Código	€ / u.	Ref.	Código	€ / u.	Ref.	Código	€ / u.	Altura total mm	Ø mm	Carga kg	Ancho Banda mm	Tipo cojinete	Ø Agujero
			21008044	2-4391	128,15	21008040	2-4389	94,00	21008042	2-4390	125,73	21008038	2-4388	108,75	201	160	350	50	Bolas	M12
21008041	2-4395	113,52	21008045	2-4397	141,80				21008043	2-4396	141,34	21008039	2-4394	126,87	242	200	400	50	Bolas	M12

Serie ZV con núcleo de poliamix y banda de poliuretano

Cabezal giratorio construido con doble hilera de bolas endurecidas. Fabricada con chapa de acero hasta 4mm de espesor. Modelo de uso universal para cargas medias. Especialmente diseñado para transporte industrial. Acabado cincado brillante. Fabricadas según normas europea EN12530/12532.

Ref.	Código	Ø mm	Carga kg	Tipo cojinete	Ancho Banda mm	Ø Agujero mm	€ / u.
716400	2-2500	80	100	Liso	32	12	6,95
716410	2-2959	80	100	Rodillos	32	12	10,75
716401	2-2480	100	150	Liso	32	12	10,70
716411	2-2960	100	150	Rodillos	32	12	14,54
716402	2-2481	125	200	Liso	32	12	16,41
716412	2-2961	125	200	Rodillos	32	12	20,17
716403	2-2482	150	250	Liso	42	20	18,40
716413	2-3441	150	250	Rodillos	42	20	22,43
716404	2-2483	200	300	Liso	50	20	28,95
716414	2-3442	200	300	Rodillos	50	20	33,01



2-2354



2-2360



2-2366

Ref.	Código	€ / u.	Ref.	Código	€ / u.	Ref.	Código	€ / u.	Ø mm	Carga kg	Ancho Banda mm	Tipo cojinete	Ø Agujero	Altura total mm
716100	2-2354	16,17	716200	2-2360	12,18	716300	2-2366	25,89	80	100	32	Liso	M8	110
716110	2-2899	20,00	716210	2-2902	16,00	716310	2-2905	29,72	80	100	32	Liso	M8	110
716101	2-2355	16,77	716201	2-2361	13,31	716301	2-2367	27,06	100L	130	32	Liso	M8	131
			716211	2-2966	18,76	716311	2-2967	32,49	100L	130	32	Liso	M8	131
716102	2-2356	21,12	716202	2-2362	16,02	716302	2-2368	30,45	100	150	32	Liso	M8	131
716112	2-2900	26,57	716212	2-2903	21,44	716312	2-2906	35,85	100	150	32	Liso	M8	131
716103	2-2357	23,74	716203	2-2363	18,83	716303	2-2369	35,31	125	200	32	Liso	M8	155
716113	2-2901	29,59	716213	2-2904	24,64	716313	2-2907	41,10	125	200	32	Liso	M8	155
716104	2-2358	45,26	716204	2-2364	35,59	716304	2-2370	55,53	150	250	42	Liso	M10	192
716114	2-3449	49,28	716214	2-3451	39,64	716314	2-3453	59,59	150	250	42	Liso	M10	192
716105	2-2359	53,71	716205	2-2365	43,90	716305	2-2371	67,39	200	300	50	Liso	M10	238

Serie ZV con rueda de poliamix.



2-0235



2-0236



2-2340

Ref.	Código	€/u.	Ref.	Código	€/u.	Ref.	Código	€/u.	Ø mm	Tipo cojinete	Carga kg	Ancho Banda mm	Ø Agujero	Altura total mm
716816	2-0235	11,73	716916	2-0236	8,67	717016	2-2340	22,31	80	Liso	130	34	M8	110
716806	2-2332	12,13	716906	2-2336	10,10	717006	2-2341	23,13	80	Rodillos	130	34	M8	110
716817	2-1001	13,13				717017	2-1901	23,96	100L	Liso	150	34	M8	131
716807	2-2333	13,83				717008	2-2343	28,24	100L	Rodillos	150	34	M8	131
716818	2-0237	18,73	716917	2-1004	9,92	717018	2-1194	25,75	100	Liso	200	34	M8	131
716808	2-2334	19,24	716907	2-2337	11,85	717007	2-2342	25,59	100	Rodillos	200	34	M8	131
716819	2-0239	23,68	716919	2-0240	17,16	717019	2-1195	29,97	125	Liso	250	35	M8	155
716809	2-2235	24,24	716909	2-2236	17,65	717009	2-2237	30,08	125	Rodillos	250	35	M8	155
716810	2-0241	33,15	716910	2-0242	24,93	717010	2-0949	46,22	150	Liso	350	45	M10	192
716811	2-0243	44,62	716911	2-0244	37,80	717011	2-0950	60,06	200	Liso	400	50	M10	238

Serie ZV con rueda de poliamix



Cabezal giratorio construido con doble hilera de bolas endurecidas. Fabricada con chapa de acero hasta 4mm de espesor. Modelo de uso universal para cargas medias. Especialmente diseñado para transporte industrial. Acabado cincado brillante. Fabricadas según normas europea EN12530/12532.

Ref.	Código	Ø mm	Carga kg	Tipo cojinete	Ancho Banda mm	Ø Agujero mm	€/u.
717106	2-2476	80	200	Rodillos	12	34	2,69
717107	2-2455	100	220	Rodillos	12	34	4,23
717108	2-2240	125	250	Rodillos	12	35	5,23
717109	2-0434	150	420	Liso	20	45	11,01
717110	4-0027	200	500	Liso	20	50	20,05



Serie ZV con banda de goma negra.



Cabezal giratorio construido con doble hilera de bolas endurecidas. Fabricada con chapa de acero hasta 4mm de espesor. Modelo de uso universal para cargas medias. Especialmente diseñado para transporte industrial. Acabado cincado brillante. Fabricadas según normas europea EN12530/12532. Soporta temperaturas hasta +250°C en intervalos de 30 minutos.



2-4434



2-4435



2-4436

Ref.	Código	€/u.	Ref.	Código	€/u.	Ref.	Código	€/u.	Altura total mm	Ø mm	Carga kg	Ancho Banda mm	Tipo cojinete	Ø Agujero
						21008050	2-4436	68,58	128	100	100	38	Liso	M12
21008049	2-4435	65,79	21008048	2-4434	73,42				133	100	100	38	Liso	M12

Aro THG con banda de goma negra. Soporta temperaturas hasta +250°C en intervalos de 30 minutos.



Ref.	Código	Ø mm	Carga kg	Tipo cojinete	Ancho Banda mm	Ø Agujero mm	€ / u.
21008051	2-4474	100	100	Liso	38	40	51,96



Serie ZVA



Fabricada con chapa de acero embutida hasta 3m/m de espesor. Freno de doble acción. Las cargas indicadas en catálogo son para andamios de altura máxima de 4 metros y suelos estables. Acabado cincado. Fabricadas según normas europeas EN12532.



Ref.	Código	€ / u.	Ref.	Código	€ / u.	Ø mm	Carga kg	Ancho Banda mm	Tipo cojinete	Altura total
719000	2-0905	59,50	719100	2-0917	59,50	200	230	46	Rodillos	234

Serie ZVI INOX con rueda poliuretano platina giratoria



Cabezal giratorio construido con doble hilera de bolas endurecidas. Fabricada con chapa de acero inoxidable (AISI 304) hasta 3mm. de espesor. Todos sus componentes de acero inoxidable. Modelo de uso universal para cargas medias. Especialmente diseñado para transporte industrial. Fabricadas según normas europea EN12530/12532.



2-2416



2-2422



2-2428

Ref.	Código	€ / u.	Ref.	Código	€ / u.	Ref.	Código	€ / u.	Ø mm	Carga kg	Ancho Banda mm	Tipo cojinete	Ø Agujero mm	Altura total mm
8002337	2-2416	35,02	8002342	2-2422	22,26	8002347	2-2428	40,38	80	100	32	Liso	8	110
8002338	2-2417	40,51	8002343	2-2423	25,75	8002348	2-2429	47,04	100	130	32	Liso	8	131
8002339	2-2419	53,79	8002344	2-2425	35,27	8002349	2-2431	68,91	125	200	32	Liso	8	155
8002340	2-2420	95,95	8002345	2-2426	63,01	8002350	2-2432	124,95	150	250	42	Liso	10	196
8002341	2-2421	109,51	8002346	2-2427	75,42	8002351	2-2433	138,49	200	300	50	Liso	10	242

Rueda recambio POL poliuretano inyectado



Ref.	Código	Ø mm	Carga kg	Ancho Banda mm	Tipo cojinete	Ø Agujero mm	€/ u.
8002352	2-2500	80	100	32	Liso	12	6,95
8002353	2-2480	100	130	32	Liso	12	10,70
8002354	2-2481	125	200	32	Liso	12	16,41
8002355	2-2482	150	250	42	Liso	20	18,40
8002356	2-2483	200	300	50	Liso	20	28,95



Serie ZVI INOX con rueda poliuretano azul elástico



Cabezal giratorio construido con doble hilera de bolas endurecidas. Fabricada con chapa de acero inoxidable [AISI 304] hasta 3mm. de espesor. Todos sus componentes de acero inoxidable. Modelo de uso universal para cargas medias. Especialmente diseñado para transporte industrial. Fabricadas según normas europea EN12530/12532.



2-2855



2-2857



2-2857

Ref.	Código	€/ u.	Ref.	Código	€/ u.	Ref.	Código	€/ u.	Ø mm	Carga kg	Ancho Banda mm	Tipo cojinete	Ø Agujero mm	Altura total mm
8002357	2-2855	35,99	8002362	2-2857	23,92	8002367	2-2856	41,04	80	100	32	Liso	8	110
8002358	2-2860	42,90	8002363	2-2862	28,99	8002368	2-2861	49,05	100	130	32	Liso	8	131
8002359	2-2870	56,98	8002364	2-2872	39,49	8002369	2-2871	71,21	125	200	32	Liso	8	155
8002360	2-2875	98,16	8002365	2-2877	67,07	8002370	2-2876	125,54	150	250	42	Liso	10	196
8002361	2-2880	112,31	8002366	2-2882	80,13	8002371	2-2881	139,68	200	300	50	Liso	10	242

Rueda recambio POL poliuretano azul elástico inyectado



Ref.	Código	Ø mm	Carga kg	Ancho Banda mm	Tipo cojinete	Ø Agujero mm	€/ u.
8002372	2-2850	80	100	32	Liso	12	9,61
8002373	2-2851	100	130	32	Liso	12	14,85
8002374	2-2852	125	200	32	Liso	12	21,59
8002375	2-2853	150	250	42	Liso	20	24,88
8002376	2-2854	200	300	50	Liso	20	36,19





Serie ZVI INOXIDABLE con rueda de poliamix

Cabezal giratorio construido con doble hilera de bolas endurecidas. Fabricada con chapa de acero inoxidable (AISI 304) hasta 3mm. de espesor. Todos sus componentes de acero inoxidable. Modelo de uso universal para cargas medias. Especialmente diseñado para transporte industrial. Fabricadas según normas europea EN12530/12532.

Ref.	Código	Ø mm	Carga kg	Tipo cojinete	Ancho Banda mm	Ø Agujero mm	€ / u.
717116	4-0023	80	200	Liso	12	34	2,16
717117	4-0024	100	220	Liso	12	34	3,25
717118	4-0025	125	250	Liso	12	35	4,56
717111	4-0046	80	200	Rodillos Inox	12	34	6,06
717112	4-0047	100	220	Rodillos Inox	12	34	6,94
717113	4-0048	125	250	Rodillos Inox	12	35	8,30



2-1325



2-1326



2-2414

Ref.	Código	€ / u.	Ref.	Código	€ / u.	Ref.	Código	€ / u.	Ø mm	Tipo cojinete	Carga kg	Ancho Banda mm	Ø Agujero	Altura total mm
717230	2-1326	19,21	717220	2-1325	32,21	717240	2-2414	43,15	80	Liso	130	34	M8	110
717130	2-2777	23,54	717120	2-2772	36,28	717140	2-2781	46,47	80	Rodillos Inox	130	34	M8	110
717231	2-1721	19,76	717221	2-1720	35,29	717241	2-1837	52,96	100L	Liso	150	34	M8	131
717131	2-2778	23,74	717121	2-2773	40,43	717141	2-2774	57,46	100L	Rodillos Inox	150	34	M8	131
717232	2-1163	23,37	717222	2-1162	48,45	717242	2-1642	68,51	100	Liso	200	34	M8	131
717132	2-2779	27,97	717122	2-2775	52,73	717142	2-2782	71,65	100	Rodillos Inox	200	34	M8	131
717233	2-1165	31,64	717223	2-1164	57,53	717243	2-1643	85,35	125	Liso	250	35	M8	155
717133	2-2780	37,01	717123	2-2776	62,24	717143	2-2783	89,02	125	Rodillos Inox	250	35	M8	155
717134	2-1167	58,24	717124	2-1166	86,66	717144	2-1644	115,72	150	Liso	350	45	M10	192
717135	2-1169	69,34	717125	2-1168	110,28	717145	2-1645	139,33	200	Liso	400	38	M10	238

Serie A con núcleo de poliamix y banda de goma gris



Fabricado con chapa de acero hasta 2,5mm de espesor. Soporte con doble rodamiento a bolas con pistas complementarias endurecidas. Con antihilos de serie. Diseñado para usos hospitalarios, hostelería y similares. Acabado cromado espejo. Fabricadas según normas europeas EN 12530

Ref.	Código	Ø mm	Carga kg	Tipo cojinete	Ancho Banda mm	Ø Agujero mm	€ / u.
717400	2-0807	80	80	Bolas	32	8	10,12
717401	2-1124	100	110	Bolas	32	8	12,59
717402	2-1125	125	135	Bolas	32	8	15,69
717403	2-1253	150	140	Bolas	32	8	29,87
717404	2-1569	200	160	Bolas	32	8	52,65



2-1425



2-1211

Ref.	Código	€ / u.	Ref.	Código	€ / u.	Ø mm	Carga kg	Ancho Banda mm	Tipo cojinete	Ø Agujero	Altura total mm
717200	2-1425	29,61				80	60	32	Bolas	M12	113
717201	2-1132	33,25	717301	2-1211	47,85	100	85	32	Bolas	M12	137
717202	2-1133	35,97	717302	2-1135	49,63	125	90	32	Bolas	M12	162
717203	2-1238	43,40	717303	2-1240	57,08	150	100	32	Bolas	M12	187
717204	2-1567	78,72	717304	2-1568	93,27	200	100	32	Bolas	M12	235



Serie BH con núcleo de poliamix y banda de goma gris



Fabricado con chapa de acero hasta 2mm de espesor. Soporte con doble rodamiento a bolas. Especialmente diseñada para: Usos de hostelería, hospitalarios, expositores, mostradores, y decoración. Acabado cincado brillante. Fabricadas según normas europeas EN12528/12530

Ref.	Código	Ø mm	Carga kg	Tipo cojinete	Ancho Banda mm	Ø Agujero mm	€/ u.
718001	2-1064	60	40	Liso	22	10	2,36
718002	2-0806	80	60	Liso	22	10	3,65
718003	2-0787	100	70	Liso	22	10	5,43



1-0180



2-4337



2-4480

Ref.	Código	€/ u.	Ref.	Código	€/ u.	Ref.	Código	€/ u.	Ø mm	Carga kg	Ancho Banda mm	Tipo cojinete	Ø Agujero	Altura total mm
21008052	2-4337	8,30	21008053	2-4480	14,02	717501	1-0163	8,59	60	40	21	Liso	M6	88
717600	2-2459	10,04	717700	1-0386	17,04	717502	1-0180	11,30	80	60	24	Liso	M6	112
717601	2-2460	10,52	717701	1-0302	18,84	717503	3-0004	12,29	100	70	25	Liso	M6	134

Serie BH con núcleo de poliamix y banda de goma gris



Fabricado con chapa de acero hasta 2mm de espesor. Soporte con doble rodamiento a bolas. Especialmente diseñada para: Usos de hostelería, hospitalarios, expositores, mostradores, y decoración. Acabado cincado brillante. Fabricadas según normas europeas EN12528/12530



Ref.	Código	€/ u.	Ref.	Código	€/ u.	Ø mm	Carga kg	Ancho Banda mm	Tipo cojinete	Ø Agujero	Altura total mm
717901	1-0170	7,62	21008054	2-4481	13,73	60	40	21	Liso	M10	85
717902	1-0179	10,72	717950	1-0387	16,54	80	60	24	Liso	M10	108
717903	3-0008	11,81	717951	1-0303	18,35	100	70	25	Liso	M10	130



Serie BH con núcleo de poliamix y banda de poliuretano

Fabricado con chapa de acero hasta 2mm de espesor. Soporte con doble rodamiento a bolas. Especialmente diseñada para: Usos de hostelería, hospitalarios, expositores, mostradores, y decoración. Acabado cincado brillante. Fabricadas según normas europeas EN12528/12530

Ref.	Código	Ø mm	Carga kg	Tipo cojinete	Ancho Banda mm	Diámetro agujero	€ / u.
718600	2-2521	60	70	Liso	22	10	2,63
718601	2-2477	80	80	Liso	22	10	4,54
718602	2-2475	100	100	Liso	22	10	5,18
718603	2-2456	125	200	Liso	32	12	11,75



2-2522



2-4338



2-4476

Ref.	Código	€ / u.	Ref.	Código	€ / u.	Ref.	Código	€ / u.	Ø mm	Carga kg	Ancho Banda mm	Tipo cojinete	Ø Agujero	Altura total mm
718100	2-2522	8,88	21008055	2-4338	8,58	21008056	2-4476	14,58	60	50	22	Liso	M6	88
718101	2-2461	11,42	718200	2-2473	10,86	718300	2-2464	20,35	80	70	24	Liso	M6	112
718102	2-2462	12,07	718201	2-2474	11,40	718301	2-2465	20,90	100	80	25	Liso	M6	134
718103	2-2463	21,48							125	100	32	Liso	M6	159

Serie BH con núcleo de poliamix y banda de poliuretano



Fabricado con chapa de acero hasta 2mm de espesor. Soporte con doble rodamiento a bolas. Especialmente diseñada para: Usos de hostelería, hospitalarios, expositores, mostradores, y decoración. Acabado cincado brillante. Fabricadas según normas europeas EN12528/12530



2-2525



2-4477

Ref.	Código	€ / u.	Ref.	Código	€ / u.	Ø mm	Carga kg	Ancho Banda mm	Tipo cojinete	Ø Agujero	Altura total mm
718400	2-2525	8,59	21008057	2-4477	14,30	60	50	22	Liso	M10	85
718401	2-2467	11,23	718500	2-2470	20,12	80	70	22	Liso	M10	108
718402	2-2468	12,28	718501	2-2471	21,01	100	80	22	Liso	M10	129
718403	2-2469	22,35				125	100	32	Liso	M10	156

Serie WL con núcleo metálico y banda neumática de 4 lonas



Buena amortiguación a los golpes. Baja resistencia a la rodadura en suelos problemáticos. La cámara de aire protege el piso. Especialmente diseñadas para carretillas de reparto, carros portabotellas, bidones, remolques, carros de almacén, plataformas. Horquilla de chapa de acero embutida.

Ref.	Código	Ø mm	Carga kg	Ancho Banda mm	Tipo cojinete	Ø Agujero	Altura total mm	€/ u.
21008058	4-0926	260	200	85	Bolas	M10	294	179,31
21008059	4-0907	260	220	85	Bolas	M10	294	184,56
718902	4-1027	260	200	Rodillos	85	20		45,17
718901	4-1072	260	200	Bolas	85	20		48,89
718903	4-1637	260	220	Rodillos	85	20		50,62
718904	4-1638	260	220	Bolas	85	20		54,35



Ref.	Código	€/ u.	Ref.	Código	€/ u.	Ø mm	Carga kg	Ancho Banda mm	Tipo cojinete	Ø Agujero	Altura total mm
718702	4-0922	122,48	718802	4-0923	97,08	260	200	85	Rodillos	M10	294
718701	4-0924	126,45	718801	4-0925	101,30	260	200	85	Bolas	M10	294
718703	4-1633	127,44	718803	4-1634	101,99	260	220	85	Rodillos	M10	294
718704	4-1635	131,70	718804	4-1636	106,30	260	220	85	Bolas	M10	294

Serie 36. Ruedas pareadas para colectividades de poliuretano termoplástico con núcleo de poliamida 6



Aptas para uso con carros de diferentes tipos en el ámbito de colectividad, en especial en la hostelería.

Ref.	Código	Capacidad de carga a 3 km/h	Ø	Ancho Banda mm	Altura total	Dimensiones pletina	Distancia entre agujeros	Diámetro agujero	Kg A	€/ u.
715000	364402	140	50	18+18	71	60x60	45x45	6	0,30	12,61

Ref.	Código	Capacidad de carga a 3 km/h	Ø	Ancho Banda mm	Altura total	Dimensiones pletina	Distancia entre agujeros	Diámetro agujero	Kg B	€/ u.
715010	368202	140	50	18+18	71	60x60	45x45	6	0,35	17,24



Serie 71. Ruedas de goma termoplástica gris anti-huella, dureza 85 shore A con núcleo de polipropileno



714201

Ref.	Código	€ / u.	Ø mm	Ancho bandaje	Dimensiones pletina	Distancia entre agujeros	Diámetro agujero	Kg A
715015	714201	10,17	80	30	107	100x85	80x60	0,60
715016	714202	10,87	100	30	128	100x85	80x60	0,70
715017	714203	15,79	125	35	156	100x85	80x60	0,86



715701

Ref.	Código	€ / u.	Ø mm	Ancho bandaje	Dimensiones pletina	Distancia entre agujeros	Diámetro agujero	Kg B
715020	715701	7,16	80	30	107	100x85	80x60	0,36
715021	715702	7,85	100	30	128	100x85	80x60	0,39
715022	715703	10,93	125	35	156	100x85	80x60	0,61

Serie 71. Ruedas de goma termoplástica gris anti-huella, dureza 85 shore A con núcleo de polipropileno. Rueda con pletina giratoria y freno doble



Ref.	Código	€ / u.	Ø mm	Ancho bandaje	Dimensiones pletina	Distancia entre agujeros	Diámetro agujero	Kg C
715025	716601	7,16	80	30	107	100x85	80x60	0,79
715026	716602	18,44	100	30	128	100x85	80x60	0,85
715027	716603	23,37	125	35	156	100x85	80x60	1,00

Serie 61. Ruedas de poliuretano termoplástico azul anti-huella, dureza 85 shore A, núcleo de poliamida 6, con rodamientos de bolas



614701

Ref.	Código	€/ u.	Ø mm	Ancho bandaje	Dimensiones pletina	Distancia entre agujeros	Diámetro agujero	Kg A
715030	614701	15,52	80	30	107	100x85	80x60	0,60
715031	614702	16,73	100	30	128	100x85	80x60	0,67
715032	614703	24,19	125	35	156	100x85	80x60	0,82



614801

Ref.	Código	€/ u.	Ø mm	Ancho bandaje	Dimensiones pletina	Distancia entre agujeros	Diámetro agujero	Kg B
715035	614801	12,51	80	30	107	100x85	80x60	0,48
715036	614802	13,73	100	30	128	100x85	80x60	0,53
715037	614803	19,33	125	35	156	100x85	80x60	0,66



614901

Ref.	Código	€/ u.	Ø mm	Ancho bandaje	Dimensiones pletina	Distancia entre agujeros	Diámetro agujero	Kg C
715040	614901	23,10	80	30	107	100x85	80x60	0,77
715041	614902	24,32	100	30	128	100x85	80x60	0,84
715042	614903	31,78	125	35	156	100x85	80x60	1,02

Serie 60. Ruedas de poliuretano termoplástico, dureza 55 shore D, núcleo de poliamida 6, con rodamientos de bolas



Ref.	Código	€ / u.	Ø mm	Ancho bandaje	Dimensiones pletina	Distancia entre agujeros	Diámetro agujero	Kg A	160
715045	608202	30,19	100	30	138	100x85	80x60	1,08	1,08
715046	608203	34,37	125	35	161	100x85	80x60	1,22	1,22



608222

Ref.	Código	€ / u.	Ø mm	Ancho bandaje	Dimensiones pletina	Distancia entre agujeros	Diámetro agujero	Kg B	160
715050	608222	18,75	100	30	138	100x85	80x60	0,67	0,67
715051	608223	22,77	125	35	161	100x85	80x60	0,76	0,76



608242

Ref.	Código	€ / u.	Ø mm	Ancho bandaje	Dimensiones pletina	Distancia entre agujeros	Diámetro agujero	Kg C	160
715055	608242	39,01	100	30	138	100x85	80x60	1,24	1,24
715056	608243	41,94	125	35	161	100x85	80x60	1,36	1,36

Serie 60 INOX. Ruedas de poliuretano termoplástico, dureza 55 shore D, núcleo de poliamida 6



60 80X30 C/B 12 SRP/NLX 80 AP.40

Ref.	Código	Ø mm	Ancho bandaje	Dimensiones pletina	Distancia entre agujeros	Diámetro agujero	Kg B	€ / u.
715060	604401	80	30	107	100x85	80x60	0,61	30,74
715061	604402	100	30	128	100x85	80x60	0,65	31,74
715062	604403	125	35	156	100x85	80x60	0,81	40,10
715063	604404	150	35	182	100x85	80x60	0,97	40,83
715064	604411	150	45	194	140x110	105x80	1,77	70,27
715065	604406	200	50	240	140x110	105x80	2,20	87,30



604401

Ref.	Código	Ø mm	Ancho bandaje	Dimensiones pletina	Distancia entre agujeros	Diámetro agujero	Kg C	€ / u.
715070	605101	80	30	107	100x85	80x60	0,35	18,44
715071	605102	100	30	128	100x85	80x60	0,40	19,44
715072	605103	125	35	156	100x85	80x60	0,64	26,19
715073	605104	150	35	182	100x85	80x60	0,81	26,92
715074	605111	150	45	194	140x110	105x80	1,33	47,24
715075	605106	200	50	240	140x110	105x80	1,74	61,68



605101

Ref.	Código	Ø mm	Ancho bandaje	Dimensiones pletina	Distancia entre agujeros	Diámetro agujero	Kg D	€ / u.
715080	606701	80	30	107	100x85	80x60	0,78	44,92
715081	606702	100	30	128	100x85	80x60	0,83	45,92
715082	606703	125	35	156	100x85	80x60	0,95	54,28
715083	606704	150	35	182	100x85	80x60	1,10	55,01
715084	606711	150	45	194	140x110	105x80	2,06	91,40
715085	606706	200	50	240	140x110	105x80	2,48	108,44



606701

Serie 62. Ruedas de poliuretano elástico TR-Roll, dureza 75 shore A, núcleo de poliamida 6



Ref.	Código	Ø mm	Ancho bandaje	Dimensiones pletina	Distancia entre agujeros	Diámetro agujero	Kg A	230	€ / u.
715130	627622	100	40	138	100x85	80x60	1,20	1,20	56,24
715131	627623	125	40	161	100x85	80x60	1,35	1,35	59,40
715132	629313	125ER	40	161	100x85	80x60	1,30	1,30	60,52



627622

Ref.	Código	Ø mm	Ancho bandaje	Dimensiones pletina	Distancia entre agujeros	Diámetro agujero	Kg B	230	€ / u.
715135	628522	100	40	138	100x85	80x60	0,82	0,82	45,16
715136	628523	125	40	161	100x85	80x60	0,93	0,93	47,82
715137	629413	125ER	40	161	100x85	80x60	0,88	0,88	48,93



628522

Ref.	Código	Ø mm	Ancho bandaje	Dimensiones pletina	Distancia entre agujeros	Diámetro agujero	Kg C	230	€ / u.
715140	627222	100	40	138	100x85	80x60	1,35	1,35	63,83
715141	627223	125	40	161	100x85	80x60	1,50	1,50	66,99
715142	629513	125ER	40	161	100x85	80x60	1,45	1,45	68,09



627222

Serie 71. Ruedas de goma termoplástica gris anti-huella con núcleo de polipropileno



Ref.	Código	Ø mm	Ancho bandaje	Dimensiones pletina	Radio de giro freno	Diámetro pletina	Kg D	€ / u.
720035	716101	80	30	110	33	120	0,38	7,49
720036	716102	100	30	127	29	120	0,41	8,73
720037	716103	125	30	154	32	120	0,57	11,53



716101

Ref.	Código	Ø mm	Ancho bandaje	Dimensiones pletina	Radio de giro freno	Diámetro pletina	Kg E	€ / u.
720040	716201	80	30	110	33	120	0,48	12,84
720041	716202	100	30	127	29	120	0,52	14,07
720042	716203	125	30	154	32	120	0,67	16,86



716201

08

Serie 62ER. Ruedas de poliuretano elástico TR-Roll con perfil redondo ergonómico, dureza 75 shore A, núcleo de aluminio



Ref.	Código	Ø mm	Ancho bandaje	Dimensiones pletina	Distancia entre agujeros	Diámetro agujero	Kg C	350	€/ u.
715145	629203	125	40	170	140x110	105x80	2,83	2,83	107,28
715146	629213	125	50	170	140x110	105x80	2,95	2,95	109,61
715147	629204	160	50	205	140x110	105x80	4,27	4,27	120,58
715148	629206	200	50	250	140x110	105x80	4,74	4,74	143,81



629203

Ref.	Código	Ø mm	Ancho bandaje	Dimensiones pletina	Distancia entre agujeros	Diámetro agujero	Kg A	350	€/ u.
720055	629023	125	40	161	100x85	80x60	2,27	2,27	79,10



629023

Ref.	Código	Ø mm	Ancho bandaje	Dimensiones pletina	Distancia entre agujeros	Diámetro agujero	Kg B	350	€/ u.
720060	629123	125	40	161	100x85	80x60	1,63	1,63	67,29



629123

Ref.	Código	Ø mm	Ancho bandaje	Dimensiones pletina	Distancia entre agujeros	Diámetro agujero	Kg C	350	€/ u.
720062	629523	125	40	161	100x85	80x60	2,83	2,83	86,68



629523

Ref.	Código	Ø mm	Ancho bandaje	Dimensiones pletina	Distancia entre agujeros	Diámetro agujero	Kg A	350	€/ u.
720065	629003	125	40	170	140x110	105x80	2,27	2,27	88,27
720066	629013	125	50	170	140x110	105x80	2,42	2,42	90,60
720067	629004	160	50	205	140x110	105x80	3,46	3,46	101,56
720068	629006	200	50	250	140x110	105x80	4,14	4,14	124,79



629003

Ref.	Código	Ø mm	Ancho bandaje	Dimensiones pletina	Distancia entre agujeros	Diámetro agujero	Kg B	350	€/ u.
720070	629103	125	40	170	140x110	105x80	1,63	1,63	69,71
720071	629113	125	50	170	140x110	105x80	2,78	2,78	72,04
720072	629104	160	50	205	140x110	105x80	2,28	2,28	80,28
720073	629106	200	50	250	140x110	105x80	2,68	2,68	101,42



629103

Serie 64. Ruedas de poliuretano TR, dureza 95 shore A, núcleo de hierro fundido



64 200X50 C/C SRP/EE LEGGERO

Ref.	Código	Ø mm	Ancho bandaje	Dimensiones pletina	Distancia entre agujeros	Diámetro agujero	Kg A	800	€/ u.
720075	648306	200	50	252	135X110	105x80	6,77	6,77	173,33



648306

Ref.	Código	Ø mm	Ancho bandaje	Dimensiones pletina	Distancia entre agujeros	Diámetro agujero	Kg B	800	€/ u.
720080	648406	200	50	252	135X110	105x80	5,79	5,79	124,39



648406

Ref.	Código	Ø mm	Ancho bandaje	Dimensiones pletina	Distancia entre agujeros	Diámetro agujero	Kg C	800	€/ u.
720085	648506	200	50	252	135X110	105x80	7,65	7,65	208,74



648506

Ref.	Código	Ø mm	Ancho bandaje	Dimensiones pletina	Distancia entre agujeros	Diámetro agujero	Kg A	1300	€/ u.
720110	648316	200	78	275	175x140	140x405	13,72	13,72	274,62
720111	648317	250	78	320	175x140	140x105	16,50	16,50	311,14
720112	648327	250	78	325	200x160	160x120	17,56	17,56	335,95



648316

Ref.	Código	Ø mm	Ancho bandaje	Dimensiones pletina	Distancia entre agujeros	Diámetro agujero	Kg B	1300	€/ u.
720115	648416	200	78	275	175x140	140x405	12,18	12,18	189,44
720116	648417	250	78	320	175x140	140x105	14,91	14,91	225,95
720117	648427	250	78	325	200x160	160x120	15,23	15,23	245,84



648416

Ref.	Código	Ø mm	Ancho bandaje	Dimensiones pletina	Distancia entre agujeros	Diámetro agujero	Kg C	1300	€/ u.
720120	648516	200	78	275	175x140	140x405	14,60	14,60	310,02
720121	648517	250	78	320	175x140	140x105	17,38	17,38	346,55
720122	648527	250	78	325	200x160	160x120	18,44	18,44	371,34



648516

Serie 79. Rodillos transpaleta de poliuretano elástico TR-Roll, dureza 7S shore A, núcleo de acero. A



Ref.	Código	Ø mm	Ancho bandedaje	Capacidad de carga a 6 km/h	Carga estática	Diámetro del eje	Profundidad alojamiento cojinetes	Facilidad de deslizamiento	Kg A	490	€/ u.
720125	792105	80	90	580	460	750	47	14	1,25	1,25	44,42
720126	792121	82	60	400	320	500	47	14	0,87	0,87	38,27
720127	792122	82	70	450	360	550	47	14	0,98	0,98	40,52
720128	792125	82	70	580	460	750	47	14	1,21	1,21	45,03
720129	792127	82	100	650	520	850	47	14	1,34	1,34	45,97
720130	792132	85	70	450	360	550	47	14	1,04	1,04	40,99
720131	792133	85	80	520	400	600	47	14	1,16	1,16	43,48
720132	792135	85	90	580	460	750	47	16	1,28	1,28	46,22
720133	792137	85	100	650	520	850	47	14	1,40	1,40	48,81



Serie 79. Rodillos transpaleta de poliuretano elástico TR-Roll, dureza 7S shore A, núcleo de acero. B



Ref.	Código	Ø mm	Ancho bandedaje	Capacidad de carga a 6 km/h	Carga estática	Diámetro del eje	Profundidad alojamiento cojinetes	Facilidad de deslizamiento	Kg B	490	€/ u.
720135	794105	80	90	580	460	750	47	14	1,06	1,06	35,08
720136	794121	82	60	400	320	500	47	14	0,67	0,67	28,91
720137	794122	82	70	450	360	550	47	14	0,79	0,79	31,16
720138	794125	82	70	580	460	750	47	14	1,03	1,03	35,66
720139	794127	82	100	650	520	850	47	14	1,15	1,15	36,61
720140	794132	85	70	450	360	550	47	14	0,84	0,84	31,63
720141	794133	85	80	520	400	600	47	14	0,96	0,96	34,12
720142	794135	85	90	580	460	750	47	16	1,08	1,08	36,86
720143	794137	85	100	650	520	850	47	14	1,20	1,20	39,46



Serie 36. Ruedas para colectividades de poliuretano termoplástico, núcleo de poliamida 6



Ref.	Código	Ø mm	Ancho bandaje	Dimensiones pletina	Distancia entre agujeros	Diámetro agujero	Diámetro pletina	Kg A	€ / u.
720199	364300	30	18	47,5	42x42	32x32	-	0,08	4,84
720200	364301	40	18	59	42x42	32x32	76	0,11	5,04
720201	364302	50	18	66	55x55	40x40	76	0,13	6,41
720202	364303	60	25	83	60x60	45x45	84	0,24	10,59



364300

Ref.	Código	Ø mm	Ancho bandaje	Dimensiones pletina	Distancia entre agujeros	Diámetro agujero	Diámetro pletina	Kg B	€ / u.
720299	365100	30	18	47,5	42x42	32x32	-	0,08	3,77
720300	365101	40	18	59	42x42	32x32	76	0,11	3,98
720301	365102	50	18	66	55x55	40x40	76	0,12	5,34
720302	365103	60	25	83	60x60	45x45	84	0,21	7,99



365100

Ref.	Código	Ø mm	Ancho bandaje	Dimensiones pletina	Distancia entre agujeros	Diámetro agujero	Diámetro pletina	Kg C	€ / u.
720400	368101	40	18	59	42x42	32x32	76	0,13	9,06
720401	368102	50	18	66	55x55	40x40	76	0,16	11,03
720402	368103	60	25	83	60x60	45x45	84	0,28	15,21



368101

Ref.	Código	Ø mm	Ancho bandaje	Dimensiones pletina	Diámetro pletina	Kg D	€ / u.
720499	363100	30	18	47,5	-	0,07	4,76
720500	363101	40	18	59	76	0,10	4,96
720501	363102	50	18	66	76	0,11	6,33
720502	363103	60	25	83	84	0,21	10,50



363100

Ref.	Código	Ø mm	Ancho bandaje	Dimensiones pletina	Diámetro pletina	Kg E	€ / u.
720600	367101	40	18	59	76	0,12	8,99
720601	367102	50	18	66	76	0,13	10,94
720602	367103	60	25	83	84	0,25	15,14



367101

Serie 61. Ruedas de poliuretano termoplástico azul anti-huella, dureza 85 shore A, núcleo de poliamida 6



61 80X30 C/B 12 SRP/NL 80 2002

Ref.	Código	Ø mm	Ancho bandaje	Dimensiones pletina	Distancia entre agujeros	Diámetro agujero	Diámetro pletina	Capacidad de carga a 6 km/h	Kg A	€/ u.
720700	614201	80	30	107	100x85	80x60	120	75	0,62	12,08
720701	614202	100	30	128	100x85	80x60	120	120	0,74	13,29
720702	614203	125	35	156	100x85	80x60	120	180	0,91	20,75
720703	614211	150	45	194	140x110	105x80	156	250	1,83	32,91
720704	614206	200	50	240	140x110	105x80	156	300	2,23	47,64



Ref.	Código	Ø mm	Ancho bandaje	Dimensiones pletina	Distancia entre agujeros	Diámetro agujero	Diámetro pletina	Capacidad de carga a 6 km/h	Kg B	€/ u.
720800	615701	80	30	107	100x85	80x60	120	75	0,38	9,07
720801	615702	100	30	128	100x85	80x60	120	120	0,43	10,28
720802	615703	125	35	156	100x85	80x60	120	180	0,66	15,90
720803	615711	150	45	194	140x110	105x80	156	250	1,46	26,47
720804	615706	200	50	240	140x110	105x80	156	300	1,81	40,64



Ref.	Código	Ø mm	Ancho bandaje	Dimensiones pletina	Distancia entre agujeros	Diámetro agujero	Diámetro pletina	Capacidad de carga a 6 km/h	Kg C	€/ u.
720900	616601	80	30	107	100x85	80x60	120	75	0,81	19,66
720901	616602	100	30	128	100x85	80x60	120	120	0,89	20,88
720902	616603	125	35	156	100x85	80x60	120	180	1,05	28,34
720903	616611	150	45	194	140x110	105x80	156	250	2,11	45,00
720904	616606	200	50	240	140x110	105x80	156	300	2,49	59,71



Serie 36. Rodillos de poliuretano termoplastico con núcleo de poliamida 6



Ref.	Código	Ø mm	Ancho bandaje	Capacidad de carga a 3 km/h	Altura total	€ / u.
2402591	364312NX	50	24	55	71	17,53
2402592	364303NX	60	25	70	82	20,26
2402593	364304NX	75	24	90	101	22,22



364312NX

Ref.	Código	Ø mm	Ancho bandaje	Capacidad de carga a 3 km/h	Altura total	€ / u.
2402594	365112NX	50	24	55	71	11,53
2402595	365103NX	60	25	70	82	13,96
2402596	365104NX	75	24	90	101	15,72



365112NX

Ref.	Código	Ø mm	Ancho bandaje	Capacidad de carga a 3 km/h	Altura total	€ / u.
2402597	368112NX	50	24	55	71	23,53
2402598	368103NX	60	25	70	82	26,26
2402599	368104NX	75	24	90	101	28,22



368112NX

Ref.	Código	Ø mm	Ancho bandaje	Capacidad de carga a 3 km/h	Altura total	€ / u.
2402600	363103NX	60	25	70	82	20,16
2402601	363104NX	75	24	90	101	22,12



363102NX

Ref.	Código	Ø mm	Ancho bandaje	Capacidad de carga a 3 km/h	Altura total	€ / u.
2402602	367103NX	60	25	70	82	26,16
2402603	367104NX	75	24	90	101	28,12



367102NX

Serie 62. Ruedas de poliuretano elástico "TR ROLL", dureza 75 shore B, núcleo de aluminio.



Silenciosa, bandaje suave, excelente facilidad de deslizamiento, apta para remolque.

Ref.	Código	Ø mm	Ancho bandaje	Capacidad de carga a 6 km/h	Carga estática	Ancho buje	Facilidad de deslizamiento	Kg B	€ / u.
721100	624102	100	40	300	300	15	10	0,39	32,25
721101	624103	125	40	350	350	20	14	0,56	46,47
721102	624104	160	50	550	550	20	14,5	1,00	52,80
721103	624106	200	50	700	700	20	14,5	1,60	71,07



Serie 62. Ruedas de poliuretano elástico "TR ROLL", dureza 75 shore A, núcleo de aluminio.



Silenciosa, bandaje suave, excelente facilidad de deslizamiento, apta para remolque.

Ref.	Código	Ø mm	Ancho bandaje	Capacidad de carga a 6 km/h	Carga estática	Ancho buje	Facilidad de deslizamiento	Kg A	€ / u.
721000	622102	100	40	300	300	15	10	0,48	39,20
721001	622103	125	40	350	350	20	14	0,81	55,83
721002	622104	160	50	550	550	20	14,5	1,25	62,16
721003	622106	200	50	700	700	20	14,5	1,85	80,43



Ref.	Código	Ø mm	Ancho bandaje	Dimensiones pletina	Distancia entre agujeros	Diámetro agujero	Diámetro pletina	Carga estática	Kg A	300	€ / u.
721200	628302	100	40	170	135x110	105x80	157	300	3,38	3,38	133,60
721201	628303	125	40	182	135x110	105x80	157	350	3,71	3,71	150,23
721202	628314	160	50	215	135x110	105x80	157	550	4,25	4,25	156,55
721203	628306	200	50	252	135x110	105x80	157	700	4,97	4,97	174,83



628302

Ref.	Código	Ø mm	Ancho bandaje	Dimensiones pletina	Distancia entre agujeros	Diámetro agujero	Diámetro pletina	Carga estática	Kg B	300	€ / u.
721300	628402	100	40	170	135x110	105x80	157	300	4,26	4,26	84,66
721301	628403	125	40	182	135x110	105x80	157	350	4,59	4,59	101,29
721302	628414	160	50	215	135x110	105x80	157	550	5,13	5,13	107,62
721303	628406	200	50	252	135x110	105x80	157	700	6,31	6,31	125,90



628402

Ref.	Código	Ø mm	Ancho bandaje	Dimensiones pletina	Distancia entre agujeros	Diámetro agujero	Diámetro pletina	Carga estática	Kg C	300	€ / u.
721400	628602	100	40	170	135x110	105x80	157	300	4,26	4,26	168,99
721401	628603	125	40	182	135x110	105x80	157	350	4,59	4,59	185,62
721402	628614	160	50	215	135x110	105x80	157	550	5,13	5,13	192,19
721403	628606	200	50	252	135x110	105x80	157	700	6,31	6,31	210,22



628602

Serie 62BS. Ruedas de Poliuretano "TR", dureza 75 shore A, núcleo de aluminio.
Rueda con cojinete a bolas



Ref.	Código	Ø mm	Ancho bandaje	Capacidad de carga a 4 km/h	€ / u.
2402604	622181	80	25	160	22,36
2402605	622182	100	30	200	27,81
2402606	622183	125	35	250	30,18
2402607	622184	150	40	450	40,08
2402608	622185	160	50	550	48,34
2402609	622186	200	50	700	63,63



622181

Ref.	Código	Ø mm	Ancho bandaje	Capacidad de carga a 4 km/h	€ / u.
2402610	624181	80	25	160	16,00
2402611	624182	100	30	200	21,15
2402612	624183	125	35	250	23,51
2402613	624184	150	40	450	30,62
2402614	624185	160	50	550	38,87
2402615	624186	200	50	700	52,41



624181

Ref.	Código	Ø mm	Ancho bandaje	Capacidad de carga a 4 km/h	Altura total	€ / u.
2402616	625951	80	25	160	107	29,71
2402617	625952	100	30	200	128	35,17
2402618	625953	125	35	220	156	40,73
2402619	625954	150	40	300	194	58,50
2402620	625960	160	50	300	198	66,74
2402621	625956	200	50	300	240	83,18



625951

Ref.	Código	Ø mm	Ancho bandaje	Capacidad de carga a 4 km/h	Altura total	€ / u.
2402622	626751	80	25	160	107	26,70
2402623	626752	100	30	200	128	32,16
2402624	626753	125	35	220	156	35,87
2402625	626754	150	40	300	194	52,06
2402626	626760	160	50	300	198	60,29
2402627	626756	200	50	300	240	76,18



626751

Ref.	Código	Ø mm	Ancho bandaje	Capacidad de carga a 4 km/h	Altura total	€ / u.
2402628	627151	80	25	160	107	37,29
2402629	627152	100	30	200	128	42,75
2402630	627153	125	35	220	156	48,31
2402631	627154	150	40	300	194	70,57
2402632	627160	160	50	300	198	78,83
2402633	627156	200	50	300	240	95,26



627151

Serie 75. Rodillos de Poliuretano "TR" con nucleo de Acero para transpaletas Pletina giratoria



Ref.	Código	Ø mm	Ancho bandaje	Capacidad de carga a 3 km/h	Altura total	€/ u.
2402634	757300	35	27	100	53	27,10
2402635	757301	50	40	150	71	44,06



757300

Ref.	Código	Ø mm	Ancho bandaje	Capacidad de carga a 3 km/h	Altura total	€/ u.
2402636	757400	35	27	100	53	32,19
2402637	757401	50	40	150	71	49,14



757400

Ref.	Código	Ø mm	Ancho bandaje	Capacidad de carga a 3 km/h	Altura total	€/ u.
2402638	757500	35	27	100	53	27,10
2402639	757501	50	40	150	71	44,06



757500

Ref.	Código	Ø mm	Ancho bandaje	Capacidad de carga a 3 km/h	Altura total	€/ u.
2402640	757600	35	27	100	53	32,19
2402641	757601	50	40	150	71	49,14



757600

Serie 65. Ruedas de poliuretano "TR", dureza 95 shore A, núcleo de aluminio. A



Ref.	Código	Ø mm	Ancho bandaje	Capacidad de carga a 6 km/h	Carga estática	Ancho buje	Facilidad de deslizamiento	Kg A	€ / u.
721502	652103	125	35	400	400	12	10	0,50	27,27
721503	651104	150	40	600	600	20	14	0,91	36,43
721504	652114	160	50	800	800	20	14,5	1,25	43,36
721505	651106	200	50	850	850	20	15	1,47	57,99



Ref.	Código	Ø mm	Ancho bandaje	Capacidad de carga a 6 km/h	Carga estática	Ancho buje	Facilidad de deslizamiento	Kg B	€ / u.
721600	654101	80	25	220	220	12	8	0,15	10,59
721601	654102	100	30	250	250	12	10	0,25	18,48
721602	654103	125	35	400	400	12	10	0,41	20,32
721603	653104	150	40	600	600	20	14	0,66	27,06
721604	654114	160	50	800	800	20	14,5	0,99	34,00
721605	653106	200	50	850	850	20	15	1,16	47,69



Ref.	Código	Ø mm	Ancho bandaje	Dimensiones pletina	Distancia entre agujeros	Diámetro agujero	Diámetro pletina	Kg A	€ / u.
721700	659301	80	25	107	100x85	80x60	120	0,72	24,46
721701	659302	100	30	128	100x85	80x60	120	0,94	32,76
721702	659303	125	35	156	100x85	80x60	120	1,14	37,81



Ref.	Código	Ø mm	Ancho bandaje	Dimensiones pletina	Distancia entre agujeros	Diámetro agujero	Diámetro pletina	Kg B	€ / u.
721800	658201	80	25	107	100x85	80x60	120	0,52	21,45
721801	658202	100	30	128	100x85	80x60	120	0,69	29,75
721802	658203	125	35	156	100x85	80x60	120	0,89	32,94



Ref.	Código	Ø mm	Ancho bandaje	Dimensiones pletina	Distancia entre agujeros	Diámetro agujero	Diámetro pletina	Kg C	€ / u.
721900	656501	80	25	107	100x85	80x60	120	0,91	32,05
721901	656502	100	30	128	100x85	80x60	120	1,08	40,34
721902	656503	125	35	156	100x85	80x60	120	1,28	45,39



Ref.	Código	Ø mm	Ancho bandaje	Dimensiones pletina	Distancia entre agujeros	Diámetro agujero	Diámetro pletina	Kg A	€ / u.
722200	659604	150	40	194	140x110	105x80	178	2,68	59,94
722201	659614	160	50	199	140x110	105x80	178	3,03	66,89



Ref.	Código	Ø mm	Ancho bandaje	Dimensiones pletina	Distancia entre agujeros	Diámetro agujero	Diámetro pletina	Kg B	€ / u.
722300	658104	150	40	194	140x110	105x80	178	2,04	48,39
722301	658114	160	50	199	140x110	105x80	178	2,38	55,33



08

Serie 65. Ruedas de poliuretano "TR", dureza 95 shore A, núcleo de aluminio. A



Ref.	Código	Ø mm	Ancho bandaje	Dimensiones pletina	Distancia entre agujeros	Diámetro agujero	Diámetro pletina	Kg C	€ / u.
722400	659704	150	40	194	140x110	105x80	178	3,16	74,13
722401	659714	160	50	199	140x110	105x80	178	3,49	81,06



Ref.	Código	Ø mm	Ancho bandaje	Dimensiones pletina	Distancia entre agujeros	Diámetro agujero	Diámetro pletina	Carga estática	Kg A	600	€ / u.
722500	657604	150	40	200	140x110	105x80	126	600	3,18	3,18	73,71
722501	657514	160	50	205	140x110	105x80	126	750	3,52	3,52	80,66
722502	657606	200	50	250	140x110	105x80	126	750	3,94	3,94	99,94



Ref.	Código	Ø mm	Ancho bandaje	Dimensiones pletina	Distancia entre agujeros	Diámetro agujero	Diámetro pletina	Carga estática	Kg B	600	€ / u.
722600	658604	150	40	200	140x110	105x80	126	600	2,19	2,19	52,44
722601	658614	160	50	205	140x110	105x80	126	750	2,53	2,53	59,38
722602	658606	200	50	250	140x110	105x80	126	750	2,48	2,48	76,56



Ref.	Código	Ø mm	Ancho bandaje	Dimensiones pletina	Distancia entre agujeros	Diámetro agujero	Diámetro pletina	Carga estática	Kg C	600	€ / u.
722700	656604	150	40	200	140x110	105x80	126	600	3,75	3,75	92,73
722701	656614	160	50	205	140x110	105x80	126	750	4,09	4,09	99,66
722702	656606	200	50	250	140x110	105x80	126	750	4,51	4,51	118,95



Grapadora y clavadora



PO,8/30K



80/16PK

Ref.	Código	Tipo accionamiento	Corona	Ancho alambre	Longitud alambre	Capacidad carro	Longitud mm	Peso kg	€ / u.
212200	PO8/30K	ClavadoraPIN	-	0,84	12-30	140	230	1	247,10
212201	80/16PK	Grapadora	12,9	0,95 x 0,65	6-16	160	225	0,9	143,50

Grapadora y clavadora



Ref.	Código	Descripción	Serie grapa/clavo	Longitud mm grapa/clavo	Capacidad del carro	Utilización	Peso Kg	€/ u.
1401900	YA90/40	Grapadora tapicería y muebles	90	19 - 40	170	Continuada	2,1	300,00
1401901	YA18/32C	Combinada clavadora/grapadora	90 - 1,2	10 - 32	100	Continuada	1,2	200,00
1401902	YA18/50	Clavadora para puertas, molduras y cajoneras	1,2	15 - 50	100	Continuada	1,5	176,00
1401903	YA64F	Clavadora para palets	2,2	18 - 64	80	Continuada	2,65	396,00
1401904	YA19/35	Grapadora embalajes cartón	35	15 - 18	100	Continuada	2,65	518,00
1401905	YA80/16	Grapadora tapicería	80	6 - 16	160	Continuada	0,90	135,00
1401906	YA8/50	Clavadora PIN pre-marcos	0,8	15 - 50	140	Continuada	1,15	303,00

Banco de trabajo

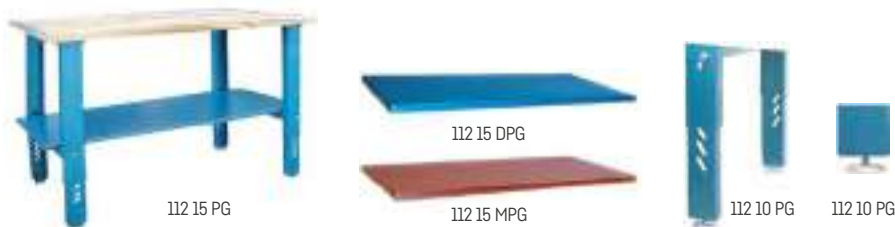

Ref.	Código	€/ u.	Ref.	Código	€/ u.	Ref.	Código	€/ u.	Longitud mm
1300000	112 10 PG	495,22	1300100	112 10 DPG	552,92	1300200	112 10 MPG	706,17	1.000
1300001	112 13 PG	532,21	1300101	112 13 DPG	596,31	1300201	112 13 MPG	793,39	1.300
1300002	112 15 PG	588,05	1300102	112 15 DPG	648,22	1300202	112 15 MPG	885,08	1.500
1300003	112 18 PG	617,95	1300103	112 18 DPG	690,47	1300203	112 18 MPG	945,85	1.800
1300004	112 20 PG	669,96	1300104	112 20 DPG	743,96	1300204	112 20 MPG	1.020,07	2.000

Banco de trabajo



BT-2 Box



BT-2 Locker



BT-6 Metal



BT-5 Box

Ref.	Código	€ / u.	Ref.	Código	€ / u.	Ref.	Código	€ / u.	Descripción	Dimensiones mm alto x ancho x fondo	Capacidad kg	Peso kg
1400050	338100945159062	18.659,00	1400065	778100945159062	18.751,00	1400075	448100945159062	18.659,00	BT-2 Box 900	1440 x 900 x 600	400	31,14
1400051	338100945126012	23.090,00	1400066	778100945126012	23.339,00	1400076	448100945126012	23.090,00	BT-2 Box 1200	1440 x 1200 x 600	600	39,70
1400052	338100945156012	26.570,00	1400067	778100945156012	26.854,00	1400077	448100945156012	26.570,00	BT-2 Box 1500	1440 x 1500 x 600	600	46,73
1400053	338100212000900	22.811,00				1400078	448100212000900	22.811,00	BT-2 Locker 900	1440 x 900 x 600	400	40,32
1400054	338100212001200	27.793,00				1400079	448100212001200	27.793,00	BT-2 Locker 1200	1440 x 1200 x 600	600	51,57
1400057	333100218841271	17.852,00				1400082	444100218841271	17.852,00	BT-6 Metal 1200	830 x 1200 x 730	800	27,3
1400058	333100218841571	20.097,00				1400083	444100218841571	20.097,00	BT-6 Metal 1500	830 x 1500 x 730	801	30,74
1400059	333100218841871	22.579,00				1400084	444100218841871	22.579,00	BT-6 Metal 1800	830 x 1800 x 730	802	34,18
1400060	338100645906092	35.566,00	1400068	778100645906092	35.658,00	1400085	448100645906092	35.566,00	BT-5 Box 900	840 x 900 x 600	400	54,89
1400061	338100645127513	44.956,00	1400069	778100645127513	45.159,00	1400086	448100645127513	44.956,00	BT-5 Box 1200	840 x 1200 x 750	600	79,48
1400062	338100645157513	51.684,00	1400070	778100645157513	51.922,00	1400087	448100645157513	51.684,00	BT-5 Box 1500	840 x 1500 x 750	600	92,5

Banco de trabajo



118



152

Ref.	Código	Descripción	Longitud mm	€ / u.
1300300	118	Banco monobloque con encimera de chapa	1.800	1.500,12
1300301	118 D	Banco monobloque con encimera DM	1.800	1.735,30
1300302	118 M	Banco monobloque con encimera de castaño	1.800	1.758,52
1300303	152 10	Encimera de chapa	1.000	638,89
1300304	152 15	Encimera de chapa	1.500	780,01
1300305	152 20	Encimera de chapa	2.000	937,98

Banco de trabajo



153 1100



153 2



133

Ref.	Código	Descripción	€/ u.
1300400	153 1100	Cajón de 515 x 600 x 200 mm	251,18
1300401	153 1200	Cajón de 515 x 600 x 300 mm	282,80
1300402	133	Cajón de 600 x 590 x 180 mm	137,89
1300403	153 2	Armario con dos cajones 515 x 600 x 300 mm	376,41
1300404	153 3	Armario con tres cajones 515 x 600 x 400 mm	496,77
1300405	153 4	Armario con cuatro cajones 510 x 650 x 510 mm	613,03

Armario para herramientas



Ref.	Código	Longitud mm	€/ u.
1300500	110 10 4	1.000	382,42
1300501	110 13 4	1.300	446,13
1300502	110 15 4	1.500	470,33
1300503	110 18 4	1.800	523,49
1300504	110 20 4	2.000	556,06
1300505	110 10 1	1.000	428,58
1300506	110 13 1	1.300	498,40
1300507	110 15 1	1.500	522,39
1300508	110 18 1	1.800	550,16
1300509	110 20 1	2.000	623,32



110 20 4



110 15 1

Armario de herramientas, panel perforado



404100211605021



404100211609021 / 404100211601221

Ref.	Código	Descripción	Dimensiones mm	Peso kg	€/ u.
1300520	404100211605021	Cabinet Tools Pannel 500	675 X 500 X 275	7,4	141,96
1300521	404100211609021	Cabinet Tools Pannel 900	675 X 900 X 275	11,72	169,29
1300522	404100211601221	Cabinet Tools Pannel 1200	675 X 1.200 X 275	14,96	189,37

Panel perforado



Ref.	Código	Longitud mm	€/ u.
1300600	145 10	1.000	95,06
1300601	145 13	1.300	116,05
1300602	145 15	1.500	133,26
1300603	145 18	1.800	157,88
1300604	145 20	2.000	175,65

145 18



Panel Perforado



Montaje en pared o en estantería.



Ref.	Código Gris	€/ u.	Ref.	Código Galvanizado	€/ u.	Ref.	Código Azul	€/ u.	Dimensiones mm alto x ancho x fondo	Peso kg
1300530	303100024904001	40,46	1300540	707100024904001	40,14	1300550	404100024904001	40,46	900 X 400	4,46
1300531	303100024906001	46,54	1300541	707100024906001	46,64	1300551	404100024906001	46,54	900 X 600	5,25
1300532	303100024124001	44,56	1300542	707100024124001	44,15	1300552	404100024124001	44,56	1.200 X 400	6,04
1300533	303100024126001	52,47	1300543	707100024126001	52,62	1300553	404100024126001	52,47	1.200 X 600	7,16

Soporte para herramientas



Montaje en pared o en estantería.



145 10 1



145 20 1

Ref.	Código	Descripción	€/ u.
1300700	145 10 1	17 Soportes herramientas mecánico	49,14
1300701	145 13 1	21 Soportes herramientas mecánico	50,27
1300702	145 15 1	27 Soportes herramientas mecánico	59,98
1300703	145 18 1	35 Soportes herramientas mecánico	64,74
1300704	145 20 1	43 Soportes herramientas mecánico	66,19

Armario de cajones



115 1 16



115 2 16

Ref.	Código	A mm	B mm	C mm	Nº de cajones	75	100	125	150	200	250	€/ u.
1300900	115 1 11	712	700	705	3	-	-	-	1	1	1	901,31
1300901	115 1 12	712	700	705	4	-	2	-	-	2	-	1.013,98
1300902	115 1 13	712	700	705	4	-	-	-	4	-	-	1.020,69
1300903	115 1 14	712	700	705	4	2	-	-	-	1	1	1.002,43
1300904	115 1 15	712	700	705	4	-	2	-	1	-	1	1.011,62
1300905	115 1 16	712	700	705	5	2	1	-	1	1	-	1.118,48
1300906	115 1 17	712	700	705	5	1	2	1	-	1	-	1.122,54
1300907	115 1 18	712	700	705	6	-	6	-	-	-	-	1.234,61
1300908	115 1 19	712	700	705	8	8	-	-	-	-	-	1.425,24
1300909	115 2 11	712	1.000	705	5	-	1	-	-	4	-	1.256,42
1300910	115 2 12	712	1.000	705	6	1	1	1	1	1	1	1.362,61
1300911	115 2 13	712	1.000	705	6	-	-	-	6	-	-	1.376,78
1300912	115 2 14	712	1.000	705	7	3	1	1	-	1	1	1.463,74
1300913	115 2 15	712	1.000	705	8	2	2	2	21	-	-	1.587,20
1300914	115 2 16	712	1.000	705	9	3	4	1	-	-	-	1.690,07
1300915	115 2 17	712	1.000	705	9	-	9	-	-	-	-	1.697,66
1300916	115 2 18	712	1.000	705	11	8	3	-	-	-	-	1.888,29
1300917	115 2 19	712	1.000	705	12	12	-	-	-	-	-	1.983,61

Armario ropero Single



Ref.	Código	Descripción	Características	Dimensiones mm	Peso kg	€/ u.
1311245	90133W1130	Mon.1 Single 300	Ropero 1 cuerpo / 1 puerta	1.800 x 300 x 500	19,00	190,26
1311246	90133W2160	Mon.2 Single 600	Ropero 2 cuerpos / 2 puertas	1.800 x 600 x 500	34,10	320,68
1311247	90133W3190	Mon.3 Single 900	Ropero 3 cuerpos / 3 puertas	1.800 x 900 x 500	49,10	464,58
1311248	90133W4112	Mon.4 Single 1200	Ropero 4 cuerpos / 4 puertas	1.800 x 1.200 x 500	64,00	608,41

Armario ropero Biplaza



Ref.	Código	Descripción	Características	Dimensiones mm	Peso kg	€ / u.
1311230	90233W1230	Mon.1 Biplaza 300	Ropero 1 cuerpo biplaza / 2 puertas	1.800 x 300 x 500	21,10	195,76
1312260	90233W2260	Mon.2 Biplaza 600	Ropero 2 cuerpos biplaza / 4 puertas	1.800 x 600 x 500	39,20	338,10
1313290	90233W3290	Mon.3 Biplaza 900	Ropero 3 cuerpos biplaza / 6 puertas	1.800 x 900 x 500	57,10	490,92
1314212	90233W4212	Mon.4 Biplaza 1200	Ropero 4 cuerpos biplaza / 8 puertas	1.800 x 1.200 x 500	75,40	638,87

Armario multiusos



Armario metálico de color Gris y medidas (alto x ancho x largo) 1800x600x400 mm. Tiene 4 estantes e incluye cerradura, llave y placa. Hecho en España, calidad europea. Medidas en uso del producto: 1803x603x401 mm



Ref.	Código	Color	Dimensiones mm	Numero de bandejas	Peso kg	€ / u.
2402642	8435104936375	GRIS	1800x600x400	4	36,37	307,69
2402643	8435104947784	GRIS	1800x800x400	4	43,7	355,01
2402644	8435104935620	GRIS	1800x600x400	4	35,87	320,29
2402645	8435104935637	GRIS	1800x800x400	4	44,41	366,66



Armario ropero, casillero



Ref.	Código	Descripción	Características	Dimensiones mm	Peso kg	€/ u.
1311320	90333W1430	Mon .1 Casillero 4-300	Armario 4 casillas (1 columna / 4 puertas)	1.800 x 300 x 500	21,20	243,31
1311321	90333W2460	Mon .2 Casillero 4-300	Armario 8 casillas (2 columna / 4 puertas)	1.800 x 600 x 500	38,20	421,41
1311322	90333W3490	Mon .3 Casillero 4-300	Armario 12 casillas (3 columna / 4 puertas)	1.800 x 900 x 500	55,10	615,13
1311323	90333W4412	Mon .4 Casillero 4-300	Armario 8 casillas (4 columna / 4 puertas)	1.800 x 1.200 x 500	72,30	860,74
1311324	90333W1440	Mon .2 Casillero 4-400	Armario 4 casillas (2 columna / 8 puertas)	1.800 x 400 x 500	24,30	250,61
1311325	90333W2480	Mon .3 Casillero 4-400	Armario 8 casillas (3 columna / 4 puertas)	1.800 x 800 x 500	44,20	499,97
1311326	90333W3412	Mon .1 Casillero 4-400	Armario 4 casillas (1 columna / 4 puertas)	1.800 x 1.200 x 500	64,10	683,74
1311327	90333W4512	Mon .4. Casillero 5-300	Armario 20 casillas (4 columna / 5 puertas)	1.800 x 1.200 x 500	78,10	876,65

Armario botiquín



Ref.	Código	Dimensiones mm	Peso kg	€/ u.
1301670	130 1	450 x 400 x 150	5,5	193,45
1301671	130 2	600 x 450 x 150	8	254,18
1301672	130 3	880 x 800 x 150	22	380,54



Banco de vestuario



Banco de vestuario con estructura metálica pintada y asiento de listones de madera.



9043810475



9043815475 / 9043820475



9043310475 / 9043315475

Ref.	Código	Descripción	Dimensiones mm	€ / u.
1311330	9043810475	Banco de madera	475 x 1.000 x 320	237,78
1311331	9043815475	Banco de madera	475 x 1.500 x 320	354,43
1311332	9043820475	Banco de madera	475 x 2.000 x 320	399,29
1311333	9043310475	Banco de acero	475 x 1.000 x 320	219,84
1311334	9043315475	Banco de acero	475 x 1.500 x 320	336,48



Banco de vestuario Single Bench

Banco de vestuario con estructura metálica



Single Bench "A"



Single Bench "B"



Single Bench "C"



Single Bench "D"

Ref.	Código	Descripción	Nº de perchas	Dimensiones mm	Peso kg	€ / u.
1311340	90438D1164	Single Bench "A"	4	1.600 x 1.000 x 350	17,00	476,28
1311341	90438D1167	Single Bench "A"	7	1.600 x 1.500 x 350	22,10	677,78
1311343	90438D1184	Single Bench "B"	4	1.800 x 1.000 x 350	20,10	595,35
1311344	90438D1187	Single Bench "B"	7	1.800 x 1.500 x 350	27,00	778,54
1311346	90438D1608	Single Bench "C"	8	1.600 x 1.000 x 670	25,20	792,27
1311347	90438D1614	Single Bench "C"	14	1.600 x 1.500 x 670	33,10	1.140,33
1311349	90438D1808	Single Bench "D"	8	1.800 x 1.000 x 670	40,10	1.053,31
1311350	90438D1814	Single Bench "D"	14	1.800 x 1.500 x 670	54,00	1.465,48

2250-O Asiento giratorio con bandeja



• Asiento redondo giratorio • Altura ajustable mediante pistón de gas: 410÷530 mm • 5 ruedas pivotantes • 2 porta-piezas pequeños/porta-herramientas, de los cuales uno es ajustable en altura • Medidas: 380x380x410÷530 mm • Peso: 6 kg

Ref.	Código	€ / u.
8005209	22500011	135,00



RSC24S/5 Cajonera móvil con 5 cajones



- 5 cajones de 588x367 mm, montados sobre guías telescópicas de rodamientos: 2 cajones altura 70 mm, 2 cajones altura 140 mm, 1 cajón altura 280 mm
- Cajón de extracción total con tirador de nailon y fibra de vidrio
- El fondo de los cajones está protegido por tapetes de goma expandida
- 4 ruedas con núcleo de acero de Ø 125 mm: 2 fijas y 2 giratorias (1 con freno)
- Cerradura de seguridad centralizada frontal
- Mesa de trabajo en ABS de alta resistencia
- Porta-frascos lateral integrado
- Predisposición para porta-papel 2400S-R/PC (pedir por separado)
- Capacidad de carga estática: 800 kg
- Medidas: 740x445x955 mm



Ref.	Código	Nº de cajones	Descripción	Color	€/ u.
8005222	24004051	5	2 cajones altura 70 mm, 2 cajones altura 140 mm, 1 cajón altura 280 mm	Naranja	909,00
8005223	24004052	5	2 cajones altura 70 mm, 2 cajones altura 140 mm, 1 cajón altura 280 mm	Gris	909,00
8005224	24004053	5	2 cajones altura 70 mm, 2 cajones altura 140 mm, 1 cajón altura 280 mm	Rojo	909,00

RSC24S/6 Cajonera móvil con 6 cajones



- 6 cajones de 588x367 mm, montados sobre guías telescópicas de rodamientos: 4 cajones altura 70 mm, 1 cajón altura 140 mm, 1 cajón altura 280 mm
- Cajón de extracción total con tirador de nailon y fibra de vidrio
- El fondo de los cajones está protegido por tapetes de goma expandida
- 4 ruedas con núcleo de acero de Ø 125 mm: 2 fijas y 2 giratorias (1 con freno)
- Cerradura de seguridad centralizada frontal
- Mesa de trabajo en ABS de alta resistencia
- Porta-frascos lateral integrado
- Predisposición para porta-papel 2400S-R/PC (pedir por separado)
- Capacidad de carga estática: 800 kg
- Medidas: 740x445x955 mm



Ref.	Código	Nº de cajones	Descripción	Color	€/ u.
8005225	24004061	6	4 cajones altura 70 mm, 1 cajón altura 140 mm, 1 cajón altura 280 mm	Naranja	924,00
8005226	24004062	6	4 cajones altura 70 mm, 1 cajón altura 140 mm, 1 cajón altura 280 mm	Gris	924,00
8005227	24004063	6	4 cajones altura 70 mm, 1 cajón altura 140 mm, 1 cajón altura 280 mm	Rojo	924,00

RC24S/7 Cajonera móvil con 7 cajones



- 7 cajones de 588x367 mm, montados sobre guías telescópicas de rodamientos: 5 cajones altura 70 mm, 1 cajón altura 140 mm, 1 cajón altura 210 mm
- Cajón de extracción total con tirador de nailon y fibra de vidrio
- El fondo de los cajones está protegido por tapetes de goma expandida
- 4 ruedas con núcleo de acero de Ø 125 mm: 2 fijas y 2 giratorias (1 con freno)
- Cerradura de seguridad centralizada frontal
- Mesa de trabajo en ABS de alta resistencia
- Porta-frascos lateral integrado
- Predisposición para porta-papel 2400S-R/PC (pedir por separado)
- Capacidad de carga estática: 800 kg
- Medidas: 740x445x955 mm



Ref.	Código	Nº de cajones	Descripción	Color	€/ u.
8005228	24004071	7	5 cajones altura 70 mm, 1 cajón altura 140 mm, 1 cajón altura 210 mm	Naranja	963,00
8005229	24004072	7	5 cajones altura 70 mm, 1 cajón altura 140 mm, 1 cajón altura 210 mm	Gris	963,00
8005230	24004073	7	5 cajones altura 70 mm, 1 cajón altura 140 mm, 1 cajón altura 210 mm	Rojo	963,00

08

RC24S/8 Cajonera móvil con 8 cajones



- 8 cajones de 588x367 mm, montados sobre guías telescópicas de rodamientos: 6 cajones altura 70 mm, 2 cajones altura 140 mm
- Cajón de extracción total con tirador de nailon y fibra de vidrio
- El fondo de los cajones está protegido por tapetes de goma expandida
- 4 ruedas con núcleo de acero de Ø 125 mm: 2 fijas y 2 giratorias (1 con freno)
- Cerradura de seguridad centralizada frontal
- Mesa de trabajo en ABS de alta resistencia
- Porta-frascos lateral integrado
- Predisposición para porta-papel 2400S-R/PC (pedir por separado)
- Capacidad de carga estática: 800 kg
- Medidas: 740x445x955 mm



Ref.	Código	Nº de cajones	Descripción	Color	€/ u.
8005231	24004081	8	6 cajones altura 70 mm, 2 cajones altura 140 mm	Naranja	1.016,00
8005232	24004082	8	6 cajones altura 70 mm, 2 cajones altura 140 mm	Gris	1.016,00
8005233	24004083	8	6 cajones altura 70 mm, 2 cajones altura 140 mm	Rojo	1.016,00

RSC24SL Cajonera móvil con 7 cajones y estantes laterales



- 8 cajones de 588x367 mm, montados sobre guías telescópicas de rodamientos: 6 cajones altura 70 mm, 2 cajones altura 140 mm
- Cajón de extracción total con tirador de nailon y fibra de vidrio
- El fondo de los cajones está protegido por tapetes de goma expandida
- 4 ruedas con núcleo de acero de Ø 125 mm: 2 fijas y 2 giratorias (1 con freno)
- Cerradura de seguridad centralizada frontal
- Mesa de trabajo en ABS de alta resistencia
- Porta-frascos lateral integrado
- Predisposición para porta-papel 2400S-R/PC (pedir por separado)
- Capacidad de carga estática: 800 kg
- Medidas: 740x445x955 mm



Ref.	Código	Nº de cajones	Descripción	Color	€/ u.
8005245	24004371	8	6 cajones altura 70 mm, 2 cajones altura 140 mm	Rojo	1.515,00
8005234	24004377	8	6 cajones altura 70 mm, 2 cajones altura 140 mm	Naranja	1.515,00
8005235	24004373	8	6 cajones altura 70 mm, 2 cajones altura 140 mm	Gris	1.515,00

RSC24SA/8 Cajonera móvil con 8 cajones, con sistema antivuelco



- 8 cajones de 588x367 mm, montados sobre guías telescópicas de rodamientos: 6 cajones altura 70 mm, 2 cajones altura 140 mm
- Cajón de extracción total con tirador de nailon y fibra de vidrio
- El fondo de los cajones está protegido por tapetes de goma expandida
- 4 ruedas con núcleo de acero de Ø 125 mm: 2 fijas y 2 giratorias (1 con freno)
- Cerradura de seguridad centralizada frontal
- Mesa de trabajo en ABS de alta resistencia
- Porta-frascos lateral integrado
- Predisposición para porta-papel 2400S-R/PC (pedir por separado)
- Capacidad de carga estática: 800 kg
- Medidas: 740x445x955 mm



Ref.	Código	Nº de cajones	Descripción	Color	€/ u.
8005243	24004187	8	6 cajones altura 70 mm, 2 cajones altura 140 mm	Naranja	1.185,00
8005244	24004183	8	6 cajones altura 70 mm, 2 cajones altura 140 mm	Gris	1.185,00

RSC24SA/6 Cajonera móvil con 6 cajones, con sistema antivuelco



- 7 cajones de 588x367 mm, montados sobre guías telescópicas de rodamientos: 5 cajones altura 70 mm, 1 cajón altura 140 mm, 1 cajón altura 210 mm
- El fondo de los cajones está protegido por tapetes de goma expandida
- 4 ruedas con núcleo de acero de Ø 125 mm: 2 fijas y 2 giratorias (2 con freno)
- Cerradura de seguridad centralizada frontal
- Mesa de trabajo de madera multicapas con orificios para colocar un tornillo de banco 1599F/100 (pedir por separado)
- Módulo lateral con estante ajustable en altura
- Porta-papel integrado
- Porta-frascos doble posterior
- Capacidad de carga estática: 1.100 kg
- Medidas: 1.050x565x973 mm



Ref.	Código	Nº de cajones	Descripción	Color	€/ u.
8005236	24004161	6	4 cajones altura 70 mm, 1 cajón altura 140 mm, 1 cajón altura 280 mm	Rojo	1.028,00
8005237	24004167	6	4 cajones altura 70 mm, 1 cajón altura 140 mm, 1 cajón altura 280 mm	Naranja	1.028,00
8005238	24004163	6	4 cajones altura 70 mm, 1 cajón altura 140 mm, 1 cajón altura 280 mm	Gris	1.028,00

RSC24SA/7 Cajonera móvil con 7 cajones, con sistema antivuelco



- 6 cajones de 588x367 mm, montados sobre guías telescópicas de rodamientos: 4 cajones altura 70 mm, 1 cajón altura 140 mm, 1 cajón altura 280 mm
- Cajón de extracción total con tirador de nailon y fibra de vidrio
- El fondo de los cajones está protegido por tapetes de goma expandida
- 4 ruedas con núcleo de acero de Ø 125 mm: 2 fijas y 2 giratorias (1 con freno)
- Cerradura de seguridad centralizada frontal
- Mesa de trabajo en ABS de alta resistencia
- Porta-frascos lateral integrado
- Predisposición para porta-papel 2400S-R/PC (pedir por separado)
- Capacidad de carga estática: 800 kg
- Medidas: 740x445x955 mm



Ref.	Código	Nº de cajones	Descripción	Color	€/ u.
8005239	24004171	7	4 cajones altura 70 mm, 1 cajón altura 140 mm, 1 cajón altura 280 mm	Rojo	1.100,00
8005240	24004177	7	5 cajones altura 70 mm, 1 cajón altura 140 mm, 1 cajón altura 210 mm	Naranja	1.100,00
8005241	24004173	7	5 cajones altura 70 mm, 1 cajón altura 140 mm, 1 cajón altura 210 mm	Gris	1.100,00

RSC24SL-CAB Cajonera móvil con 7 cajones y armario porta-objetos



- 7 cajones de 588x367 mm, montados sobre guías telescópicas de rodamientos: 5 cajones altura 70 mm, 1 cajón altura 140 mm, 1 cajón altura 210 mm
- Cajón de extracción total con tirador de nailon y fibra de vidrio
- El fondo de los cajones está protegido por tapetes de goma expandida
- 4 ruedas con núcleo de acero de Ø 125 mm: 2 fijas y 2 giratorias (1 con freno)
- Cerradura de seguridad centralizada frontal
- Mesa de trabajo en ABS de alta resistencia
- Porta-frascos lateral integrado
- Predisposición para porta-papel 2400S-R/PC (pedir por separado)
- Capacidad de carga estática: 800 kg
- Medidas: 740x445x955 mm



Ref.	Código	Nº de cajones	Descripción	Color	€/ u.
8005242	24004471	7	5 cajones altura 70 mm, 1 cajón altura 140 mm, 1 cajón altura 210 mm	Rojo	1.565,00
8005246	24004477	7	5 cajones altura 70 mm, 1 cajón altura 140 mm, 1 cajón altura 210 mm	Naranja	1.565,00
8005247	24004473	7	5 cajones altura 70 mm, 1 cajón altura 140 mm, 1 cajón altura 210 mm	Gris	1.565,00

08

RSC24SA-XL/7 Cajonera móvil con 7 cajones, con sistema antivuelco, modelo largo

- 7 cajones de 588x367 mm, montados sobre guías telescópicas de rodamientos: 5 cajones altura 70 mm, 1 cajón altura 140 mm, 1 cajón altura 210 mm
- El fondo de los cajones está protegido por tapetes de goma expandida
- 4 ruedas con núcleo de acero de Ø 125 mm: 2 fijas y 2 giratorias (2 con freno)
- Cerradura de seguridad centralizada frontal
- Armario lateral porta-objetos con estante interno ajustable y puerta con cerradura
- Mesa de trabajo de madera multicapas con orificios para colocar un tornillo de banco 1599F/100 (pedir por separado)
- Porta-papel integrado
- Porta-frascos doble posterior
- Capacidad de carga estática: 1.100 kg
- Medidas: 1.050x565x973 mm



Ref.	Código	Nº de cajones	Descripción	Color	€/ u.
8005248	24004271	7	5 cajones altura 70 mm, 1 cajón altura 140 mm, 1 cajón altura 210 mm	Rojo	1.395,00
8005249	24004277	7	5 cajones altura 70 mm, 1 cajón altura 140 mm, 1 cajón altura 210 mm	Naranja	1.395,00
8005250	24004273	7	5 cajones altura 70 mm, 1 cajón altura 140 mm, 1 cajón altura 210 mm	Gris	1.395,00

RSC24SA-XL/8 Cajonera móvil, con sistema antivuelco, modelo largo

- 7 cajones de 882x367 mm, montados sobre guías telescópicas de rodamientos: 5 cajones altura 70 mm, 1 cajón altura 140 mm, 1 cajón altura 210 mm
- Cajón de extracción total con sistema de desenganche rápido en nailon, reforzado con fibra de vidrio, con posibilidad de apertura por toda la longitud del cajón, con porta-etiquetas integrado
- El fondo de los cajones está protegido por tapetes de goma expandida
- 4 ruedas con núcleo de acero de Ø 125 mm: 2 fijas y 2 giratorias (1 con freno)
- Cerradura de seguridad centralizada frontal
- Mesa de trabajo en ABS de alta resistencia, con 6 bandejas porta-piezas pequeñas
- Porta-frascos lateral integrado
- Predisposición para porta-papel 2400S-R/PC (pedir por separado)
- Capacidad de carga estática: 1.000 kg
- Medidas: 1.035x445x970 mm



Ref.	Código	Nº de cajones	Descripción	Color	€/ u.
8005251	24004281	7	5 cajones altura 70 mm, 1 cajón altura 140 mm, 1 cajón altura 210 mm	Rojo	1.495,00
8005252	24004287	8	6 cajones altura 70 mm, 2 cajones altura 140 mm	Naranja	1.495,00
8005253	24004283	8	6 cajones altura 70 mm, 2 cajones altura 140 mm	Gris	1.495,00

RSC24SA-XL/9 Cajonera móvil, con sistema antivuelco, modelo largo

- 8 cajones de 882x367 mm, montados sobre guías telescópicas de rodamientos: 6 cajones altura 70 mm, 2 cajones altura 140 mm
- Cajón de extracción total con sistema de desenganche rápido en nailon, reforzado con fibra de vidrio, con posibilidad de apertura por toda la longitud del cajón, con porta-etiquetas integrado
- El fondo de los cajones está protegido por tapetes de goma expandida
- 4 ruedas con núcleo de acero de Ø 125 mm: 2 fijas y 2 giratorias (1 con freno)
- Cerradura de seguridad centralizada frontal
- Mesa de trabajo en ABS de alta resistencia, con 6 bandejas porta-piezas pequeñas
- Porta-frascos lateral integrado
- Predisposición para porta-papel 2400S-R/PC (pedir por separado)
- Capacidad de carga estática: 1.000 kg
- Medidas: 1.035x445x970 mm



Ref.	Código	Nº de cajones	Descripción	Color	€/ u.
8005254	24004291	8	6 cajones altura 70 mm, 2 cajones altura 140 mm	Rojo	1.590,00
8005255	24004297	9	8 cajones altura 70 mm, 1 cajón altura 140 mm	Naranja	1.590,00
8005256	24004293	9	8 cajones altura 70 mm, 1 cajón altura 140 mm	Gris	1.590,00

Carro de taller 95 A PRO



Carro de taller Tool Trolley TTS de última generación. Cajones bloqueables de fácil extracción con apertura total sobre rodillos. Concepto de seguridad de tres niveles (cierres centralizado e individual y sistema antivuelco). Empuñadura de transporte de acero inoxidable con conexión reforzada al carro para facilitar las maniobras, laterales con protección contra impactos. Bandeja de ABS resistente al desgaste, disolventes y Skydrol. Ruedas de marcha suave resistentes a aceites y ácidos (Ø 125 mm) con protección para evitar la entrada de polvo y 2 ruedas con freno de estacionamiento, soporte para rollos de papel, perforaciones en ambos laterales para herramientas grandes, disponible en cinco colores (verde, rojo, azul, negro y blanco) y equipable con bandejas STAHLWILLE: Standard y TCS.



Ref.	Código	Nº de cajones	Dimensiones mm	Peso kg	€/u.
700255	81200160	6	1.021 x 823 x 497	65,5	1.626,00
700256	81200163	7	1.021 x 823 x 497	69,5	1.659,00
700257	81200166	8	1.021 x 823 x 497	74	1.684,00

Carro de taller



Ref.	Código	Descripción	€/u.
1308804	1485K4	Cofre robusto de 4 cajones	631,50
1308801	1472K5	Carro robusto de 5 cajones con amortiguadores de protección	898,16
1308802	1472K6	Carro robusto de 6 cajones con amortiguadores de protección	935,84
1308803	1472K7	Carro robusto de 7 cajones con amortiguadores de protección	972,99

1470KC3 - Carro de tres bandejas



2 estructuras de aluminio en U.
Ruedas de 25x100mm con rodamientos y de TPR para evitar marcado.
2 móviles.
2 móviles con freno.
Dimensiones internas de las bandejas: (3x) 750 x 425 x 77 mm.



Ref.	Código	Peso kg	Icon1	Icon2	Icon3	Icon4	Icon5	€/u.
1201275	1470KC3	25,5	759 x 43 x 1.025	150	759 x 432 x 77	50	25 x 100	198,04

C04TSS/7 Cajonera móvil con 7 cajones, de acero inoxidable



- 7 cajones de 570x410 mm montados sobre guías telescópicas de rodamientos: 6 cajones altura 83 mm, 1 cajón altura 170 mm
- 4 ruedas con núcleo de acero de Ø 125 mm: 2 fijas y 2 giratorias (2 con freno)
- Cerradura de seguridad centralizada frontal
- Estructura completamente de acero inoxidable AISI 304
- Ruedas, soportes, rodamientos, interior de los cajones y guías correspondientes de acero inoxidable
- Tirador de los cajones de aluminio
- Medidas: 680x470x935 mm

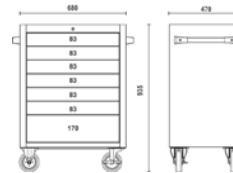

Ref.	Código	€/ u.
8005258	24003077	3.030,00

1475K - Carro C75 Clásico



Carro Classic

Ref.	Código	Nº de cajones	Dimensiones mm	€/ u.
2402651	1475K7	7	986x501x763	1.055,04
2402652	1475K8	8	986x501x763	1.096,50
2402653	1475KXL12	12	1100x501x1100	1.652,81
2402654	1475KXL6	6	986x501x1100	1.500,89
2402655	1475KXL6C	6	986x501x1100	1.610,18
2402656	1475KXL7	7	986x501x1100	1.555,53
2402657	1475KXL8	8	986x501x1100	1.599,25
2402658	1475KXXL8CWTSS	8	1505x500x1218	4.662,48

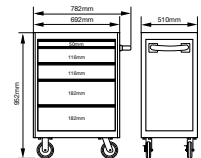

1477K - Carro E77



Carro 26"

Ref.	Código	Nº de cajones	Dimensiones mm	€/ u.
2402659	1477K6	6	693x510x965	1.326,02
2402660	1477K7	7	693x510x966	1.391,59
2402661	1477K8	8	693x510x967	1.424,39
2402662	1477K9	9	693x510x968	1.468,09

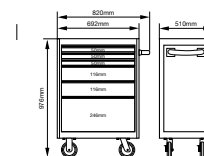

93/6 A



Compacto y robusto carro de taller de última generación, cajones bloqueables de fácil extracción con apertura total sobre rodillos, Concepto de seguridad de dos niveles [cierre centralizado e individual], Empuñadura de transporte estable para facilitar las maniobras, Bandeja de plástico resistente al desgaste y a los disolventes, Ruedas de marcha suave resistentes a aceites y ácidos (Ø 100 mm) con freno de estacionamiento.

Ref.	Código	Nº de cajones	Dimensiones mm	Peso kg	€/ u.
8001870	81200154	6	912x780x499	53,2	1.321,00



C27S Carro porta-herramientas compacto y extensible



• Carro extensible con columnas abatibles para facilitar el transporte • 2 cajones de 588x277 mm, montados sobre guías telescópicas que permiten la apertura en dos sentidos • Amplio departamento inferior porta-objetos de 588x277x220 mm • Estructura en chapa • 2 ruedas fijas de Ø 160 mm y 2 ruedas pivotantes de Ø 100 mm [2 con freno] • Mesa de trabajo en material termoplástico con 6 cubetas pequeñas porta-objetos integradas • Cerradura de seguridad centralizada • Preparado para el alojamiento de separadores para cajón y termoformados porta-herramientas MC • Medidas Abierto: 765x395x995 mm • Medidas Cerrado: 765x395x570 mm



Ref.	Código	Color	€/ u.
8005259	27000201	Naranja	826,00

RSC51-FO-Carro auxiliar con 3 cajones



Encimera de trabajo reforzada en ABS, sólida y robusta. Superficie de apoyo multifunciones con bordes anticaida y 8 orificios para el alojamiento de destornilladores. 3 cajones de 588x367 mm, montados sobre guías telescópicas de rodamientos, altura 70 mm. Cerradura de seguridad centralizada frontal. Práctico soporte para destornilladores lateral incluido. 2 soportes laterales para aerosoles incorporados. Amplio estante inferior protegido con alfombrilla de caucho anti-aceite y anti-gasolina. 4 ruedas de Ø 125 mm: 2 fijas y 2 giratorias (una con freno). Capacidad de carga estática: 400 kg. Capacidad de cada cajón: 15 kg distribuidos uniformemente



Ref.	Código	Nº de cajones	Color	€/ u.
2402663	51000300	3	Naranja	594,00

C27S Carro porta-herramientas compacto y extensible



• Carro extensible con columnas abatibles para facilitar el transporte • 2 cajones de 588x277 mm, montados sobre guías telescópicas que permiten la apertura en dos sentidos • Amplio departamento inferior porta-objetos de 588x277x220 mm • Estructura en chapa • 2 ruedas fijas de Ø 160 mm y 2 ruedas pivotantes de Ø 100 mm [2 con freno] • Mesa de trabajo en material termoplástico con 6 cubetas pequeñas porta-objetos integradas • Cerradura de seguridad centralizada • Prep de separadores para cajón y termoformados porta-herramientas MC • Medidas A



Ref.	Código	Color	€/ u.
8005260	27000202	Gris	826,00
8005261	27000203	Rojo	826,00



13217 - Caja - Trolley



Trolley de herramientas extremadamente robusto de polipropileno de alta resistencia para el ámbito profesional. 5 cajones de fácil extracción con cierre individual y tapa transparente con tope de extracción en 3 alturas diferentes. Los cajones se pueden introducir en cualquier orden. Con una tapa superior y una tapa frontal amovible. La tapa superior está forrada con espuma para fijar con seguridad las herramientas. 1 bandeja extraíble con dos 2 asideros y 2 tapas de cajón transparentes bajo la tapa superior. Los cajones se pueden utilizar como cajas de herramientas independientes gracias a la tapa transparente. Posibilidad de rotular individualmente la caja y los cajones. 2 ruedas dobles de marcha suave en el lado de la empuñadura telescópica. Se puede equipar con el juego de ruedas R 13217 (en pedido aparte) para el transporte en posición vertical sobre 4 ruedas. Empuñadura telescópica para facilitar el transporte. 2 asas de transporte laterales. Resistente al Skydrol, la acetona, la gasolina y los aceites hidráulicos. 60 kg de capacidad de carga. Posibilidad de cierre con candado en 3 posiciones. Cajas portátiles.



Ref.	Código	Descripción	Dimensiones mm	€/ u.
700265	81091301	13217LGE	457x585x381	878,00
700267	81091304	13217LR	457x585x381	878,00
700268	81091306	13217TS	457x585x381	878,00

1470KC2 - Carro dos bandejas



Bandejas de gran capacidad para almacenar productos pequeños. Fabricado y diseñado para un montaje fácil y rápido. Dos estructuras en U de aluminio. 4 ruedas de 25x100mm con rodamientos y con superficie TPR para no marcar. 2 móviles. 2 móviles con freno. Dimensiones interiores de las 2 bandejas: 750x425x77 mm.



Ref.	Código	Peso kg	Icon1	Icon2	Icon3	Icon4	Icon5	€/ u.
1201276	1470KC2	19	759 x 432 x 1025	150	759 x 432 x 77	50	25 x 100	181,63

C41S Trolley porta-herramientas con 2 cajones



- Estructura en chapa y material plástico: gran robustez y peso reducido
- 2 módulos separables: 1 cesta superior, 1 módulo con 1 cajón altura 95 mm y 1 cajón altura 295 mm
- Ruedas de gran diámetro (160 mm), incorporadas a la estructura para facilitar el transporte incluso en escalones
- Cerradura de seguridad centralizada lateral para cerrar los cajones del módulo inferior
- Cajones montados sobre guías telescópicas de rodamientos con gancho de cierre doble
- Mango telescópico de aluminio
- Porta-piezas pequeñas integrado en la cesta superior
- Medidas: 536x335x871 mm

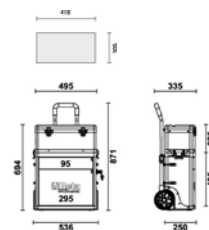

Ref.	Código	€/ u.
8005266	41000001	637,00



C41H-O Trolley porta-herramientas con 3 cajones



- Estructura en chapa y material de plástico: gran robustez y peso reducido
- 2 módulos separables: 1 cesta superior y 1 módulo con 3 cajones
- Ruedas de gran diámetro (160 mm), incorporadas a la estructura para facilitar el transporte incluso en escalones
- Cerradura de seguridad centralizada lateral para cerrar los cajones del módulo inferior
- Cajones montados sobre guías telescópicas de rodamientos con gancho de cierre doble
- Mango telescópico de aluminio
- Porta-piezas pequeñas integrado en la cesta superior
- Medidas: 536x335x920 mm

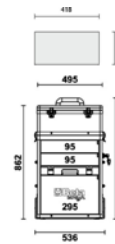

Ref.	Código	€/ u.
8005267	41000002	705,00

C22W-O Baúl porta-herramientas de chapa



- Forrado internamente de madera para una mayor protección de las herramientas
- Estructura en chapa de acero, espesor de 1,5 mm
- Gancho de cierre con predisposición para candado
- Asas laterales para el transporte
- Bisagra posterior de acero para aumentar la robustez
- Bandeja porta-piezas pequeñas extraíble
- Peso: 15 kg
- Medidas: 690x300x360 mm



Ref.	Código	€/ u.
8005214	22000269	211,50

C22S Cajonera portátil con 3 cajones



3 cajones de 588x277 mm, montados sobre guías telescópicas de rodamientos:

1 cajón altura 50 mm,

2 cajones altura 70 mm.

Cerradura de seguridad centralizada frontal.

Tiradores laterales para el transporte

• Medidas: 700x330x334 mm



Ref.	Código	€/ u.
8005216	22003001	478,00
8005217	22003007	478,00
8005218	22003003	478,00

Caja de herramientas



Ref.	Código	Dimensiones mm largo x ancho x alto	N° departamentos	€/ u.
1302000	101 3	400 x 215 x 110	1	
1302001	101 5	400 x 215 x 170	1	
1302002	102 3	330 x 175 x 140	3	
1302003	102 5	400 x 220 x 210	3	
1302004	102 5 1	400 x 245 x 230	3	
1302005	102 5	400 x 210 x 195	3	
1302006	102 7	485 x 245 x 230	3	
1302007	108 5	430 x 205 x 210	5	
1302008	108 7	530 x 205 210	5	



1027



1025

08

1496MB-Caja de albañil



Caja metálica de albañil

Ref.	Código	Dimensiones mm largo x ancho x alto	€/ u.
2402664	1496MB2	530x290x290	130,20
2402665	1496MB3	690x360x310	155,02
2402666	1496MB4	830x440x340	186,02
2402667	1496MB5	910x530x530	302,36



C23ST Cajonera portátil



• 5 cajones de 588x367 mm, montados sobre guías telescópicas de rodamientos: 5 cajones altura 70 mm • Cerradura de seguridad centralizada frontal
• Posibilidad de incorporación del kit con 4 ruedas y barra [2300ST/KIT] • Medidas: 740x445x454 mm

Ref.	Código	Nº de cajones	Color	€/ u.
8005219	23003020	5	Naranja	845,00
8005220	23003027	5	Gris	845,00
8005221	23003023	5	Rojo	845,00



Caja de herramientas, de acero inoxidable



• Alta resistencia a la corrosión • Evita la oxidación incorrecta • Características mecánicas sobresalientes • Acero inoxidable AISI 420 • 100% de acero inoxidable • Puede utilizarse en entornos críticos, en áreas donde no está permitido el nivel mínimo de contaminación, evita la formación incorrecta de óxido y puede esterilizarse en autoclave a 121 °C

Ref.	Código	Dimensiones mm largo x ancho x alto	Nº departamentos	€/ u.
21020006	21203001	450x200x210	5	298,00



Serie K candados de latón



Arco normal

Ref.	Código	A mm	B mm	C mm	Ø D	Longitud mm	€/ u.
2411700	011500	17,5	17	11	3	8,5	7,09
2411701	012000	21	21,5	13,5	3,5	10,5	7,27
2411702	012500	25	22,5	17	4	13	7,47
2411703	013000	30	27	17,5	5	15,5	8,75
2411704	014000	40	32	22,5	6	23	11,94
2411705	015000	50	40	28	8	29	18,23
2411706	016000	60	46	36	10	35	24,73
2411707	017000	70	51	41	12	40	33,55

Arco largo

Ref.	Código	A mm	B mm	C mm	Ø D	Longitud mm	€/ u.
2411800	012010	21	21,5	24	3,5	10,5	7,39
2411801	012510	25	22,5	25	4	13	7,68
2411802	013010	30	27	32	5	15,5	8,98
2411803	014010	40	32	43	6	23	12,41
2411804	015010	50	40	48	8	29	18,75

Candado serie Z



Arco normal

Ref.	Código	A mm	B mm	C mm	Ø D	Longitud mm	€/u.
2411900	001500	17,5	17,5	10,5	3	8	7,85
2411901	002000	22	22,5	13	4	11	8,06
2411902	002500	26,5	27	14,5	5	12	8,51
2411903	003500	34,5	34,5	19,5	6	17	10,41
2411904	004500	44	41,5	25	7,5	23	12,26
2411905	005500	54	44,5	36	8,5	30	14,31

Arco largo

Ref.	Código	A mm	B mm	C mm	Ø D	Longitud mm	€/u.
2412000	002010	22	22,5	21	4	11	8,13
2412001	002510	26,5	27	25,5	5	12	8,90
2412002	003510	34,5	34,5	29	6	17	10,91
2412003	004510	44	41,5	40	7,5	23	12,73

Candado serie inox. Excelente comportamiento en zonas húmedas. Arco normal



Arco normal

Ref.	Código	A mm	B mm	C mm	Ø D	Longitud mm	€/u.
2412100	083000	30	27	17	5	15,5	15,75
2412101	084000	40	32	22,5	6	23	19,71
2412102	085000	50	40	28	8	29	25,09

Arco largo

Ref.	Código	A mm	B mm	C mm	Ø D	Longitud mm	€/u.
2412200	083010	30	27	32	5	15,5	16,28
2412201	084010	40	32	42	6	23	20,64
2412202	085010	50	40	49	8	29	26,11

Candado serie U

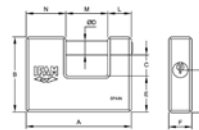

Ref.	Código	Modelo	A mm	B mm	C mm	Ø D	E mm	F	H mm	Longitud mm	M	N	€/u.
715370	000770	U-70	70	55	15,5	12	24	19,5	26,5	14	22	34	25,47
715371	000790	U-90	90	64,5	17,5	12	31,4	19,7	36,5	20	36	34	38,06

Candado Armoured

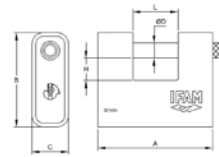

Ref.	Código	A mm	B mm	C mm	Longitud mm	H mm	D mm	€/ u.
715375	052060	60	55	25	22	11	10	40,03
715376	052080	80	69	29	31	14	11	55,96
715377	052090	90	75	29	36	18	12	59,88

Candado de alta seguridad

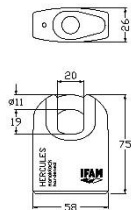

051200



051400



051900

Ref.	Código	Descripción	€/ u.
2412300	051200	Candado Hércules. Cuerpo macizo de acero carbonitrurado. Bombillo antiganzúa de alta seguridad protegido al taladro por dos escudos.	148,37
2412303	051400	Candado Titan. Cuerpo macizo de acero cementado. Arco de acero anticizalla de diámetro 14. Bombillo antiganzúa de alta seguridad. Llave reversible de puntos con millones de combinaciones.	161,33
2412304	051900	Candado Huno. Cuerpo y arco de acero macizo, endurecido y niquelado. Anillos protectores para impedir el corte o apalancamiento del arco. Cerradura de puntos de seguridad con llave reversible.	122,17

Candado seguridad extrema



Candado Granit con cilindro de disco ABUS 37/55: el cilindro de disco para las necesidades de seguridad más exigentes. Con el Granit 37/55 pueden cerrarse vestíbulos, puertas, portales, contenedores, camiones, etc. Gracias a su revestimiento Black Granit que lo protege contra la corrosión, es especialmente adecuado para su uso en exteriores. El cilindro de disco Plus de ABUS proporciona además una protección elevada frente a intentos de manipulación.



Ref.	Código	Anchura cuerpo	Altura total	Grosor cuerpo	Distancia interior arco	Altura interior arco	Diámetro arco	Nivel seguridad	€/ u.
20034261	37ST/55 SZP B	62mm	84,5mm	30mm	27mm	26mm	12mm	10	190,08
20034262	37/55 SZP B	62,5mm	84mm	30mm	27,50mm	26mm	11mm	10	141,03
20034263	37/55HB50 SZP B	62,5mm	108,5mm	30mm	27,50mm	50mm	11mm	10	159,42

Candado combinación alta seguridad



Robusto cuerpo de aleación de cinc en fundición de colada por inyección. Arco de acero endurecido. Candado con cierre de doble enganche. Garantizan la seguridad de equipajes, cajas de herramientas o taquillas de centros deportivos, entre otras cosas.



Ref.	Código	Anchura cuerpo	Altura total	Grosor cuerpo	Distancia interior arco	Altura interior arco	Diámetro arco	Nivel seguridad	n° dígitos	€ / u.
8000824	158CS/65 B	69mm	116mm	26mm	25,50mm	35mm	10mm	9	5	94,90
8000825	158CS/50 B	52mm	96mm	23mm	23mm	27mm	8mm	6	4	45,67
8000826	158/65 B	60mm	116mm	26mm	31mm	40mm	10mm	5	5	74,55
8000827	158/50 B	52mm	101mm	26mm	25,5mm	33,5mm	8mm	5	4	36,49

Candado combinación aluminio



Ideal para asegurar maletas, taquillas en colegios y centros deportivos, cajas registradoras, joyeros, armarios, cajas de herramientas, cuadros de mando, etc



Ref.	Código	Anchura cuerpo	Altura total	Grosor cuerpo	Distancia interior arco	Altura interior arco	Diámetro arco	Nivel seguridad	n° dígitos	€ / u.
8000828	145/40 PLATA	41,50mm	77mm	17,50mm	21,50mm	25mm	6mm	4	4	15,10
8000829	145/30 PLATA	31,50mm	65mm	15,50mm	14mm	26mm	5mm	3	3	12,47
8000830	145/20 PLATA	22,50mm	52,50mm	13,50mm	9mm	22mm	3mm	3	3	11,16

Candado TITANIUM



Candados amaestrados



Ref.	Código	Anchura cuerpo	Altura total	Grosor cuerpo	Distancia interior arco	Altura interior arco	Diámetro arco	€ / u.
2402668	64TI/30 MK	30mm	49,5mm	13mm	16mm	17mm	5mm	14,47
2402669	64TI/40 MK	40mm	62mm	14,5mm	22mm	23mm	6,5mm	18,61
2402670	64TI/50 MK	50mm	77mm	17mm	29mm	29mm	8mm	30,42
2402671	64TI/30HB30 MK	30mm	64mm	13mm	16mm	30mm	5mm	14,87
2402672	64TI/30HB60 MK	30mm	93mm	13mm	16mm	60mm	5mm	16,64
2402673	64TI/40HB40 MK	40mm	78mm	14,5mm	22mm	40mm	6,5mm	20,33
2402674	64TI/40HB63 MK	40mm	101mm	14,5mm	22mm	63mm	6,5mm	21,44
2402675	64TI/50HB50 MK	50mm	93,5mm	17mm	29mm	50mm	8mm	33,03
2402676	64TI/50HB80 MK	50mm	128,5mm	17mm	29mm	80mm	8mm	36,33

Candado TITALIUM



El material TITALIUM™ se basa en una aleación especial de aluminio ligera que destaca por su combinación de resistencia y ligereza. Al igual que en la construcción de aviones, con los candados TITALIUM™ ABUS apuesta por dos propiedades esenciales: gran estabilidad y peso ligero. Esta actualización del producto se refleja también en el diseño del mismo; todos los candados de la serie TITALIUM™ convencerán gracias a su apariencia de acero inoxidable.



Ref.	Código	Anchura cuerpo	Altura total	Grosor cuerpo	Distancia interior arco	Altura interior arco	Diámetro arco	Nivel seguridad	€/ u.
20034264	98TI/90	90mm	60mm	28mm	35mm	18mm	12mm	8	61,54
8000820	96CSTI/60	60mm	91mm	28mm	25mm	29mm	11mm	8	63,22
8000821	96CSTI/50	50mm	82mm	23mm	23mm	25mm	9,5mm	8	45,71
8000822	96TI/60	60mm	103mm	28mm	25mm	40mm	11mm	8	48,93
8000823	96TI/50	50mm	92mm	23mm	25mm	34mm	9,5mm	8	36,32
20034265	64TI/50HB60-150 B	50mm	60-150mm	17mm	29mm	80mm	8mm	6	30,26

Cierre universal con candado Diskus. Especial furgonetas



Pareja puerta trasera y lateral con la misma llave. Cierre universal con candado Diskus llave puntos ABUS PLUS integrado blanco



Ref.	Código	Anchura	Altura	Fondo	Diámetro	Tipo llave	Color	Nivel seguridad	€/ u.
20034270	141+142+20/70 Blanco KA	222mm	86,50mm	30mm	13mm	ABUS PLUS	blanco	9	152,43
20034271	141+142+25/70 Blanco KA	222mm	86,50mm	30mm	13mm	puntos	blanco	8	145,32
20034272	141+142+26/70 Blanco KA	222mm	86,50mm	30mm	13mm	serreta	blanco	8	145,32

Cilindro 1000WX



Ref.	Código	Acabado	A mm	B mm	L mm	Leva	Seguridad	€/ u.
2402677	060200	Latón	30	30	60	Larga	Alta	61,24
2402678	060210	Níquel	30	30	60	Larga	Alta	67,22
2402679	060300	Latón	30	35	65	Larga	Alta	65,25
2402680	060310	Níquel	30	35	65	Larga	Alta	71,25
2402681	061000	Latón	35	35	70	Larga	Alta	67,31
2402682	061010	Níquel	35	35	70	Larga	Alta	73,89
2402683	060400	Latón	30	40	70	Larga	Alta	67,31
2402684	060410	Níquel	30	40	70	Larga	Alta	73,89
2402685	060250	Latón	30	30	60	Corta	Alta	61,24
2402686	060260	Níquel	30	30	60	Corta	Alta	67,22

Cilindro Iridium

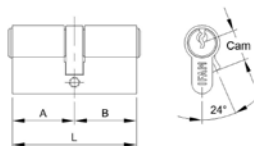

Ref.	Código	Acabado	A mm	B mm	L mm	Leva	Seguridad	€ / u.
2402687	035200IRM	Latón	30	30	60	Larga	Media-alta	41,38
2402688	035210IRM	Níquel	30	30	60	Larga	Media-alta	45,50
2402689	035300IRM	Latón	30	35	65	Larga	Media-alta	44,01
2402690	035310IRM	Níquel	30	35	65	Larga	Media-alta	48,39
2402691	036000IRM	Latón	35	35	70	Larga	Media-alta	45,71
2402692	036010IRM	Níquel	35	35	70	Larga	Media-alta	50,22
2402693	035400IRM	Latón	30	40	70	Larga	Media-alta	45,71
2402694	035410IRM	Níquel	30	40	70	Larga	Media-alta	50,22
2402695	035250IRM	Latón	30	30	60	Corta	Media-alta	41,38
2402696	035260IRM	Níquel	30	30	60	Corta	Media-alta	45,50

Cilindro Platinum

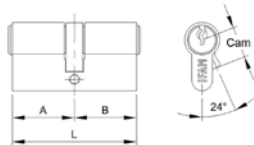

Ref.	Código	Acabado	A mm	B mm	L mm	Leva	Seguridad	€ / u.
2402697	035200PTM	Latón	30	30	60	Larga	Media	22,00
2402698	035210PTM	Níquel	30	30	60	Larga	Media	24,19
2402699	035300PTM	Latón	30	35	65	Larga	Media	23,42
2402700	035310PTM	Níquel	30	35	65	Larga	Media	25,74
2402701	036000PTM	Latón	35	35	70	Larga	Media	24,33
2402702	036010PTM	Níquel	35	35	70	Larga	Media	26,72
2402703	035400PTM	Latón	30	40	70	Larga	Media	24,33
2402704	035410PTM	Níquel	30	40	70	Larga	Media	26,72
2402705	035250PTM	Latón	30	30	60	Corta	Media	22,00
2402706	035260PTM	Níquel	30	30	60	Corta	Media	24,19

Cilindro Start



Ref.	Código	Acabado	A mm	B mm	L mm	Leva	Seguridad	€/ u.
2402707	715500	Latón	30	30	60	Larga	Básica	12,02
2402708	715510	Níquel	30	30	60	Larga	Básica	13,21
2402709	715600	Latón	30	35	65	Larga	Básica	13,46
2402710	715610	Níquel	30	35	65	Larga	Básica	14,80
2402711	716500	Latón	35	35	70	Larga	Básica	13,98
2402712	716510	Níquel	35	35	70	Larga	Básica	15,36
2402713	715700	Latón	30	40	70	Larga	Básica	13,98
2402714	715710	Níquel	30	40	70	Larga	Básica	15,36
2402715	715550	Latón	30	30	60	Corta	Básica	12,02
2402716	715560	Níquel	30	30	60	Corta	Básica	12,02
2402717	700500	Latón	30	30	60	Larga	Básica	7,96
2402718	700510	Níquel	30	30	60	Larga	Básica	9,86
2402719	700610	Níquel	30	35	65	Larga	Básica	10,98
2402720	701500	Latón	35	35	70	Larga	Básica	9,57
2402721	701510	Níquel	35	35	70	Larga	Básica	11,55
2402722	700700	Latón	30	40	70	Larga	Básica	9,57
2402723	700710	Níquel	30	40	70	Larga	Básica	11,55
2402724	700550	Latón	30	30	60	Corta	Básica	7,96
2402725	700560	Níquel	30	30	60	Corta	Básica	9,86

Escudo



Ref.	Código	Acabado	Ø D mm	€/ u.
2402726	025024	Latón	61	17,70
2402727	025026	Níquel	61	18,10

Guardallaves



Ref.	Código	Fondo mm	Ancho mm	Alto mm	Arco	€/ u.
2402728	020174	38	85	120	NO	40,56
2402729	020185	45	78,5	126,5	SÍ	42,59
2402730	020189	19	59,5	90	SÍ	25,32
2402731	020192	70	90	140	NO	50,06
2402732	020194	70	90	185	SÍ	50,46

Bolsa de herramientas



Bolsa herramientas BN-1 (13"). 345x220x225 mm.



Ref.	Código	Dimensiones mm largo x ancho x alto	Descripción	€/ u.
715340	80005	345 x 220 x 225	Bolsa de nylon, negra y roja	20,38
715341	82009	455 x 250 x 265	Bolsa de nylon, fondo de politeno, negra y roja	43,57

3875 - Bolsa de herramientas para trabajos en altura



Ref.	Código	Descripción	€/ u.	Ref.	Código	Descripción	€/ u.
2402733	3875-BP2	Mochila pequeña de poliéster duradero de 210 mm x 330 mm x 450 mm	127,81	2402737	3875-HB60	Bolsa para elevación con correa reforzada simple de elevación de 640 mm x Ø350 mm	114,12
2402734	3875-HB10	Bolsa para trabajos en altura de 130 mm x 260 mm x 130 mm	8,88	2402738	3875-MHP6	Bolsa con 2 bolsillos grandes y 6 anillas de seguridad para su fijación a lanyards	90,80
2402735	3875-HB100	Bolsa para elevación con dos correas reforzadas de elevación de 900 mm x 400 mm	184,46	2402739	3875-SB70	Bolsa para elevación para maleta rígida con dos correas reforzadas de elevación de 300 mm x 500 mm x 730 mm	252,78
2402736	3875-HB30	Bolsa para elevación con correa reforzada simple de elevación de 350 mm x Ø270 mm	91,26				

Maleta de herramientas



La nueva bandeja inferior con ruedas integradas ofrece mucho espacio de almacenamiento, la carcasa del maletín antideslizante hecha de plástico XABS con acabado antideslizante proporciona además un buen agarre. Carga máxima 30 kgr.



489500171



5363000031



30000581



5480000041



689500171

Ref.	Código	Descripción	Dimensiones mm largo x ancho x alto	Volumen litros	Peso grs.	€ / u.
1302102	489500171	Maleta con ruedas y asa telescópica posterior. Bandejas portaherramientas y bolsa portadocumentos. Bandeja inferior con subdivisiones variables	470x360x200	35	6.800	415,70
1302103	5363000031	Maleta de cuero con tapa semiabatible. Bandejas laterales y base de HDPE. Refuerzos de aluminio. Correa opcional.	420x160x250	17	2.600	122,90
1302111	30000581	Maleta cuero auténtico, negra. Modelo recomendado para electricistas	220 x 140 x 250	8	1.300	109,30
1302112	5480000041	Maleta cuero industrial, extra larga, negra. Modelo recomendado para fontaneros	635 x 185 x 270	45	2.500	164,50
21089000	689500171	Trolley de nueva generación, con ruedas blandas, mango telescópico de 4 tramos de aluminio, permite transportar cargas hasta 30 kgr. 50 compartimentos.	470x210x360	36	7.95	425,70

C6T Mochila-trolley porta-herramientas en textil técnico, con ruedas, vacía



• Mango telescópico para el transporte • Ruedas incorporadas a la estructura, con una cobertura antipolvo para cuando se usa como mochila • 2 paneles porta-herramientas internos retirables • Bolsillo interno para PC y 5 bolsillos externos • Base de material plástico resistente al agua • Peso: 4,5 kg • Medidas: 480x370x220 mm

Ref.	Código	€ / u.
8005207	21060010	229,00



C5S-Mochila porta-herramientas



• Asa doble en la parte superior central de la mochila para un agarre seguro y equilibrado. Dos bolsillos frontales amplios. Dos bolsillos internos de gran cabida y 2 franjas con velcro añadidas. Práctica bolsa enrollable interna, compuesta por 4 paneles porta-herramientas. Tirantes reforzados ajustables. Carga máxima 15 kg

Ref.	Código	€ / u.
2402740	21050100	57,00



Mochila porta-herramientas en tejido técnico, vacía



Capacidad máxima 30 Kg. Base reforzada de plástico duro para poder apoyar en el suelo. Panel rígido con 56 alojamientos.

Ref.	Código	€/u.
8005588	4055	83,90



C11 Cesta porta-herramientas en textil técnico, vacía



• Base rígida de material plástico resistente al agua • Gomas y bolsillos porta-herramientas, tanto internos como externos • Sobres porta-documentos integrados en el doble fondo de la tapa • Peso: 2 kg • Medidas: 400x240x220 mm

Ref.	Código	€/u.
8005208	21110000	101,50



Bolsillo de herramientas



Cinturón herramientas simple

Ref.	Código	Descripción	€/u.
715345	89602	Bolso de nylon simple	10,66



0021 50 - Mochila porta-herramientas, vacía



Ligera, flexible y única: la mochila de herramientas modular para todos aquellos que no hacen concesiones en su trabajo. Se adapta a usted y a sus herramientas: práctica y cómoda gracias a la parte delantera y trasera totalmente abatibles, al separador portaherramientas extraíble y al acolchado para su espalda.



Ref.	Código	Carga máx. kg.	Volumen l.	€/u.
2402741	00 21 50 LE	15	18	321,30
2402742	00 21 50 E	15	18	1.124,04

Ref.	Código	Carga máx. kg.	Volumen l.	€/u.
2402743	00 21 50 S	15	18	811,82

0021 33 - Maleta porta-herramientas



Para trabajos exigentes: muchas herramientas, fáciles de transportar. Lista cuando usted lo desee: para las condiciones más duras - polipropileno resistente a impactos, antipolvo, resistente al agua y a la temperatura. El trabajo duro se convierte en trabajo inteligente: máxima flexibilidad gracias a 19 bolsillos para herramientas, 61 lazos de sujeción y al sistema adaptable de separadores de aluminio



Ref.	Código	Carga máx. kg.	Volumen l.	€ / u.	Ref.	Código	Carga máx. kg.	Volumen l.	€ / u.
2402744	00 21 33 LE	24	26.4	479,30	2402746	00 21 33 S	24	26.4	969,82
2402745	00 21 33 E	24	26.4	1.282,04					

Caja de herramientas de plástico



Caja herramientas nº 21



Ref.	Código	Dimensiones mm largo x ancho x alto	Contenido	€ / u.
1302300	121005	310 x 160 x 130	1 bandeja	6,07
1302301	122002	356 x 184 x 163	1 bandeja	9,32
1302302	123009	356 x 184 x 163	1 bandeja y 1 estuche	11,24
1302303	124006	400 x 206 x 188	1 bandeja	11,45
1302304	125003	400 x 206 x 188	1 bandeja y 1 estuche	13,84
1302305	115004	500 x 258 x 255	1 bandeja	24,24
1302306	116001	500 x 258 x 255	1 bandeja y 1 estuche	29,13
1302307	117008	580 x 290 x 290	1 bandeja	32,39
1302308	118005	580 x 290 x 290	1 bandeja y 1 estuche	38,67
1302309	119002	580 x 290 x 290	1 bandeja y 1 estuche	40,27

Caja de herramientas de plástico - aluminio



Caja herramientas nº 400



Ref.	Código	Dimensiones mm largo x ancho x alto	Contenido	€ / u.
1306700	162008	400 x 225 x 190	1 bandeja	15,78
1306701	163005	450 x 285 x 250	1 bandeja	28,26
1306702	164002	450 x 285 x 250	1 bandeja y 1 estuche	34,02
1306703	165009	500 x 295 x 270	1 bandeja	32,57
1306704	166006	500 x 295 x 270	1 bandeja y 1 estuche	38,37
1306705	167003	600 x 305 x 295	1 bandeja	39,93
1306706	168000	600 x 305 x 295	1 bandeja y 1 estuche	47,28

Caja de Herramientas QBRICK SYSTEM TWO



• Caja de Herramientas modular compatible con QBRICK SYSTEM TWO. • Estructura sólida extra-resistente. • Cierres de poliamida ultra-resistentes. • Asa ergonómica duradera. • Compartimentos ajustables y multifuncionales. • Orificio para candado. • Hasta 19 Kg de carga máxima. • Capacidad para 6 Mini Organizadores (39005).



Ref.	Código	Dimensiones mm	Capacidad L	€/ u.
21006042	39003	526 x 307 x 221	26	48,14

Caja de herramientas FORMULA CARBO



• Estructura sólida extra-resistente. • Tapa de policarbonato ultra-resistente a prueba de golpes. • Organizador con contenedores extraíbles en la parte superior. • Cierres de aluminio reforzado. • Asa transversal ergonómica de aluminio. • Convertible en mesa de trabajo estable y portátil. • Bandeja interior incluida. • Orificio para candado.



39020



39021



39022

Ref.	Código	Dimensiones mm	Capacidad L	€/ u.
21006045	39020	462 x 256 x 242	22	33,63
21006046	39021	547 x 271 x 278	32	39,05
21006047	39022	595 x 289 x 328	41	46,75

Caja herramientas QBRICK SYSTEM PRO



• Caja de Herramientas modular QBRICK SYSTEM PRO • Estructura sólida extra-resistente. • Tapa de policarbonato a prueba de golpes. • Cierres de poliamida ultra-resistentes. • Asa transversal ergonómica de aluminio. • Sellado de goma interior para evitar penetraciones de agua y polvo. • Posibilidad de acoplar una caja encima de la otra. • Carga máxima hasta 15 Kg. • Bandeja interior incluida. • Orificio para candado.



39010



39011



39012

Ref.	Código	Dimensiones mm	Capacidad L	€/ u.
21006048	39010	450 x 260 x 240	14	40,70
21006049	39011	545 x 270 x 246	22	58,20
21006050	39012	650 x 270 x 272	29	72,21

Cofre herramientas de plástico



Cofre Herramientas nº 50



Ref.	Código	Dimensiones mm largo x ancho x alto	Contenido	€ / u.
1302400	150005	675 x 472 x 416	2 bandejas y 5 palomillas	86,77
1302401	151002	675 x 472 x 416	2 bandejas y 2 estuches	94,33
1302402	153006	775 x 472 x 493	2 bandejas y 5 palomillas	101,82

Trail box



Trail Box nº 57



157004

158001

159008

Ref.	Código	Dimensiones mm largo x ancho x alto	Contenido	Medidas embalaje mm	€ / u.
1306800	157004	470 x 290 x 630	1 bandeja	476 x 296 x 640	53,58
1306801	158001	470 x 290 x 630	1 bandeja, 1 estuche	476 x 296 x 640	64,24
1306802	159008	Trail-Box Prof. Nº 59	3 estuches, 2 maletas	780 x 510 x 420	186,78

Estuche con compartimentos fijos



Estuche separadores fijos nº 11-12

Ref.	Código	Dimensiones mm largo x ancho x alto	Nº departamentos	€ / u.
1302500	50107	250 x 140 x 54	12	3,59
1302501	51104	250 x 140 x 54	7	3,59
1302502	60106	290 x 195 x 54	21	4,70
1302503	61103	290 x 195 x 54	11	4,70
1302504	70105	330 x 255 x 54	32	6,00
1302505	71102	330 x 255 x 54	17	6,00



Taller móvil modular QBRICK SYSTEM TWO



• Taller Móvil Compacto 3 en 1 totalmente modular. • Organizador (14 l) + Caja Herramientas (26 l) + Carro de Herramientas con ruedas (38 l). • Estructura reforzada de alta calidad. • Cierres de poliamida ultra-resistentes. • Fácil ensamblaje con asas laterales ergonómicas y robustas. • Estructura sólida extra-resistente. • Asa telescópica de aluminio. • Eje vertical metálico. • Ruedas de goma con eje metálico y asa telescópica. • Uso seguro. • Sin extremidades punzantes. • Resistente a la intemperie y a temperaturas bajo cero. • Hasta 35 kg de carga máxima. • Todo en 1.



Ref.	Código	Dimensiones mm	Capacidad L	€/ u.
21006040	39001	526 x 380 x 670	78	183,88

Trolley QBRICK SYSTEM TWO



• Trolley modular compatible con QBRICK SYSTEM TWO. • Estructura sólida extra-resistente. • Cierres de poliamida ultra-resistentes. • Asa telescópica de aluminio. • Eje vertical metálico. • Ruedas de goma con eje metálico y asa telescópica. • Compartimentos ajustables y multifuncionales. • Incluye compartimento para destornilladores. • Hasta 35 kg de carga máxima.



Ref.	Código	Dimensiones mm	Capacidad L	€/ u.
21006043	39004	526 x 380 x 670	38	104,09

Mini organizador QBRICK SYSTEM TWO



• Mini organizador individual compatible con Caja Herramientas (39003) QBRICK SYSTEM TWO. • Tapa de policarbonato ultra-resistente. • 10 compartimentos ajustables. • Estructura sólida extra-resistente. • Insertable en Caja de Herramientas (39003).



Ref.	Código	Dimensiones mm	€/ u.
21006044	39005	180 x 260 x 60	12,86

Estuche con compartimentos fijos y móviles



Estuche separadores fijos nº 20-9

Ref.	Código	Dimensiones mm largo x ancho x alto	Nº departamentos	€/ u.
1306900	20001	190 x 150 x 42	-	2,72
1306901	21008	256 x 192 x 42	-	3,56
1306902	22005	312 x 238 x 51	21	8,09
1306903	23002	388 x 290 x 61	21	11,16
1306904	24009	460 x 350 x 81	21	16,35



Estuche con cajones extraíbles



Estuche con cajones extraíbles nº 430/50/50

Ref.	Código	Dimensiones mm largo x ancho x alto	Nº departamentos	€/ u.
1307000	30000	430 x 370 x 55	50/ A50	28,03
1307001	31007	430 x 370 x 55	10/A50 10/B50 5/C50	25,62



Organizador QBRICK SYSTEM TWO



-Organizador modular compatible con QBRICK SYSTEM TWO. - Tapa de policarbonato ultra-resistente. - 9 contenedores extraíbles y multifuncionales. - Cierres de poliamida ultra-resistentes. - Asa ergonómica duradera. - Hasta 19 Kg de carga máxima.



Ref.	Código	Dimensiones mm	Capacidad L	€ / u.
21006041	39002	526 x 307 x 126	14	50,80

Maletín organizador HD



-Organizador mixto con contenedores extraíbles y separadores. -Tapa de policarbonato ultra-resistente. - Esquinas anti-choque. - Cierres de aluminio. - Asa ergonómica duradera.



Ref.	Código	Dimensiones mm	Capacidad L	€ / u.
21006051	39060	390 x 400 x 110	7	37,32

Maletín organizador HD



-Organizador mixto con contenedores extraíbles y separadores. -Tapa de policarbonato ultra-resistente. - Esquinas anti-choque. - Cierres de aluminio. - Asa ergonómica duradera.



Ref.	Código	Dimensiones mm	Capacidad L	€ / u.
21006052	39061	390 x 600 x 110	29	52,76

Gaveta de plástico



Gaveta apilable nº 51 azul



Ref.	Código	Dimensiones mm largo x ancho x alto	Color	Capacidad L	€ / u.
1302900	251023	170 x 100 x 80	Azul	0,8	1,30
1302901	251108	170 x 100 x 80	Rojo	0,8	1,30
1307100	251344	170 x 100 x 80	Transparente	0,8	1,40
1302902	252020	236 x 160 x 130	Azul	3,2	3,26
1302903	252105	236 x 160 x 130	Rojo	3,2	3,26
1307101	252341	236 x 160 x 130	Transparente	3,2	3,59
1302904	253027	336 x 160 x 130	Azul	4,8	4,50
1302905	253102	336 x 160 x 130	Rojo	4,8	4,50
1307102	253348	336 x 160 x 130	Transparente	4,8	4,95
1302906	254024	336 x 216 x 155	Azul	7,7	6,07
1302907	254109	336 x 216 x 155	Rojo	7,7	6,07
1307103	254345	336 x 216 x 155	Transparente	7,7	6,68
1302908	255021	336 x 216 x 200	Azul	10,1	7,65
1302909	255106	336 x 216 x 200	Rojo	10,1	7,65

Ref.	Código	Dimensiones mm largo x ancho x alto	Color	Capacidad L	€ / u.
1307104	255342	336 x 216 x 200	Transparente	10,1	8,43
1302910	256028	420 x 270 x 175	Azul	13,9	9,95
1302911	256103	420 x 270 x 175	Rojo	13,9	9,95
1307105	256349	420 x 270 x 175	Transparente	13,9	10,93
1302912	258022	500 x 303 x 200	Azul	22,2	15,31
1302913	258107	500 x 303 x 200	Rojo	22,2	15,31
1307106	258343	500 x 303 x 200	Transparente	22,2	16,86
1302914	259029	500 x 303 x 300	Azul	34	22,79
1302915	259104	500 x 303 x 300	Rojo	34	22,79
1307107	259340	500 x 303 x 300	Transparente	34	25,03
1302916	260025	600 x 400 x 300	Azul	51,3	34,40
1302917	260100	600 x 400 x 300	Rojo	51,3	34,40
1307108	260346	600 x 400 x 300	Transparente	51,3	37,83

Gaveta de plástico



GAVETA N° 51 GRIS NO ALIMENTARIA



Ref.	Código	Dimensiones mm largo x ancho x alto	Color	Capacidad L	€/ u.
2402747	251061	170 x 100 x 80	gris	0.8	1,01
2402748	252068	236 x 160 x 130	gris	3.2	2,38
2402749	253065	336 x 160 x 130	gris	4.8	3,42
2402750	254062	336 x 216 x 155	gris	7.7	4,63
2402751	255069	336 x 216 x 200	gris	10.1	5,73

Ref.	Código	Dimensiones mm largo x ancho x alto	Color	Capacidad L	€/ u.
2402752	256066	420 x 270 x 175	gris	13.9	7,32
2402753	258060	500 x 303 x 200	gris	22.2	11,28
2402754	259067	500 x 303 x 300	gris	34	16,80
2402755	260063	600 x 400 x 300	gris	51.3	24,48

Estante clasificador apilable



Multibox n° 1



301001



302008



309007

Ref.	Código	Dimensiones exteriores mm	N° de estuches	Dimensiones gavetas mm	€/ u.
1303098	301001	335 x 250 x 275	4	-	42,96
1303099	302008	360 x 447 x 314	4	-	68,29
1303100	304002	360 x 170 x 190	4	160 x 170 x 80	18,92
1303101	306006	360 x 170 x 190	6	100 x 170 x 80	18,92
1303102	309007	360 x 170 x 190	9	100 x 170 x 50	18,92
1303103	312007	360 x 170 x 190	12	80 x 170 x 50	18,92

Gaveta plegable apilable



Gaveta plegable n° 52P azul

Ref.	Código	Dimensiones mm largo x ancho x altura	Color	€/ u.
1307200	202025	236 x 160 x 130	Azul	10,56
1307201	202346	236 x 160 x 130	Transparente	11,60
1307202	203022	336 x 160 x 130	Azul	15,26
1307203	203343	336 x 160 x 130	Transparente	16,80
1307204	204029	336 x 216 x 155	Azul	5,91
1307205	204340	336 x 216 x 155	Transparente	6,52
1307206	206023	420 x 270 x 175	Azul	9,96
1307207	206344	420 x 270 x 175	Transparente	10,94
1307208	209024	500 x 303 x 300	Azul	17,95
1307209	209345	500 x 303 x 300	Transparente	19,74
1307210	210020	600 x 400 x 300	Azul	26,39
1307211	210341	600 x 400 x 300	Transparente	29,05



08

Módulo apilable



Ref.	Código	Dimensiones exteriores mm	Nº de cajones	Dimensiones cajones mm	€/ u.
1307301	346002	280 x 167 x 140	6	150 x 127 x 37	11,99
1307302	347009	280 x 167 x 140	3 6	150 x 127 x 37 150 x 62 x 37	11,99
1307303	348006	280 x 167 x 140	12	150 x 62 x 37	11,99

Contenedor basculante



Ref.	Código	Dimensiones mm largo x ancho x alto	Cajones	€/ u.
2402756	333606	600 x 196 x 241	3	69,11
2402757	334603	600 x 168 x 206	4	52,80
2402758	335600	600 x 133 x 165	5	41,70
2402759	336607	600 x 92 x 114	6	25,61
2402760	339608	600 x 63 x 84	9	22,56



Módulo metálico



Módulo metálico 20/2/1

Ref.	Código	Dimensiones Exteriores mm	€/ u.
1307402	315008	305 x 145 x 328	47,37
1307403	316005	305 x 145 x 328	47,37
1307404	317002	305 x 145 x 237	38,30
1307405	318009	305 x 145 x 237	38,30



Estantería metálica con cajones



Kit estantería 301

Ref.	Código	Bandejas	Cajones	€/ u.
1307500	398308	16	120	1.070,01
1307501	398315	16	60	997,74
1307502	398322	12	48	1.055,17
1307503	398339	15	20	1.021,22
1307504	399305	16	120	1.440,77
1307505	399312	16	60	1.263,71
1307506	399329	12	48	1.246,52
1307507	399336	15	40/20/16	1.397,57



Euro-cajas para almacén y transporte



Euro Caja 6415 azul

Ref.	Código	Dimensiones mm largo x ancho x alto	Peso kg	Carga L	€/ u.
1307600	261008	600 x 400 x 150	1,23	22	17,54
1307601	262005	600 x 400 x 200	1,62	34	21,02
1307602	263002	600 x 400 x 300	2,16	51	26,29
1307603	264009	600 x 400 x 400	2,74	69	32,83
1307604	299001	605 x 405 x 29	0,615	-	9,99



Euro Caja 6424-T

Ref.	Código	Dimensiones mm largo x ancho x alto	Peso kg	Carga L	€/ u.
1307650	265006	600 x 400 x 240	2,49	39	31,51
1307651	266003	600 x 400 x 340	2,98	58	36,40
1307652	267000	600 x 400 x 440	3,69	75	43,26

Cestón Metálico



Ref.	Código	€/ u.	Ref.	Código	€/ u.	Dimensiones mm largo x ancho x alto interior
1303400	5040	240,00	1303500	5034-A	270,00	800 x 500 x 400
1303402	5041	330,00	1303502	5035-A	350,00	1.000 x 800 x 500
1303403	5042	375,00	1303503	5036-A	395,00	1.200 x 800 x 500
1303404	5043	405,00	1303504	5037-A	425,00	1.200 x 1.000 x 500

Contenedor basculante para carretilla elevadora



12042 / 12043 / 12045 / 12046



12030 / 12031 / 12040 / 12041

Ref.	Código	Dimensiones mm Largo x Ancho x Alto	Peso kg	Carga kg	€/ u.
1303420	12042	Útil de 800 para contenedor ref. 12043	60	2.000	755,00
1303421	12043	Contenedor 1.200 x 800 x 920	100	2.000	525,00
1303422	12045	Contenedor 1.200 x 1.000 x 920	110	2.000	565,00
1303423	12046	Útil de 1.000 para contenedor ref. 12045	80	2.000	795,00
1303424	12030	1.545x1.000x1.080	130	1.500	1.260,00
1303425	12031	1.860 x 1.250 x 1.245	175	2.000	1.660,00
1303426	12040	1.545 x 1.000 x 1.080	110	1.500	1.125,00
1303427	12041	1.860 x 1.250 x 1.045	155	2.000	1.520,00

Almacenaje de bidones



Ref.	Código	Dimensiones mm largo x ancho x alto	Peso kg	Carga kg	Capacidad ltrs.	€/u.
1303600	3030	1.395 x 660 x 350	16	500	2 bidones de 220	145,00
1303601	3035	1.400 x 600 x 1.050	40	800	3 bidones de 200	260,00
1303604	3037-GL	1.455 x 1.455 x 688	190	1.300	1 depósito de 1.000	965,00
1303605	3037-GRX	2.650 x 1.300 x 465	180	3.800	2 depósitos de 1.000	1.480,00

Contenedores autobasculantes



Ref.	Código	Dimensiones mm Largo x Ancho x Alto	Peso kg	Carga kg	Capacidad ltrs.	€/u.
21085000	12026	1.860 x 1.600 x 1.245	210	2.000	1.500	1.800,00
21085001	12036	1.860 x 1.600 x 1.045	200	2.000	1.500	1.730,00

Bidón con cánula



Bidon 5 litros cánula

Ref.	Código	Capacidad L	€/u.
1303610	601354	5	8,45
1303611	602351	10	11,61
1303612	603358	20	19,60
1303613	604355	30	27,78



Bidón con grifo



Bidón 5 litros tapón/grifo

Ref.	Código	Capacidad L	€/ u.
1303620	601361	5	10,09
1303621	602368	10	13,92
1303622	603365	20	22,71
1303623	604362	30	31,25



Depósito



Ref.	Código	Capacidad L	Peso kg	€/ u.
21085003	3039-PM	300	45	290,00
1307801	3039-PH	600	54	395,00
1307800	3039-H	1000	59	400,00



Caseta y armario de seguridad



14010

Ref.	Código	Medidas	Descripción	€/ u.
715416	14010	1.200 x 600 x 1.950	Armario ignífugo RF 90. Cierre automático. 80 kg por balda	4.150,00

Protección medio ambiente



3061



3078-P



3063

Ref.	Código	Dimensiones mm largo x ancho x alto	Capacidad ltrs.	Peso kg	Nº de bidones	Carga kg	€/ u.
1303630	3061	1.260 x 830 x 390	220	28	2	900	315,00
21085002	3060	1.240 x 1.240 x 347	274	41	4	1.600	430,00
1303631	3086	2.480 x 1.285 x 500	1.140	80	2	2.500	1.190,00
1303632	3078-P	900 x 700 x 235	75	9	-	500	135,00
1303633	3063	1.240 x 1.240 x 1.006	1.016	76	1	2.200	900,00



Estantería sin tornillos

Estantería metálica 5 estantes. Sin tornillos, el sistema más fácil y rápido de montaje



Simonclick Plus



Maderclick Plus



Simontaller St

Ref.	Código	Descripción	Dimensiones mm	Capacidad kg/ balda	Peso kg	€/ u.
1303650	457100024201035	Simonclick Plus 5/300	2.000 x 1.000 x 300	180	21,82	112,17
1303651	457100024201045	Simonclick Plus 5/400	2.000 x 1.000 x 400	180	24,68	126,59
1303652	457100024201055	Simonclick Plus 5/500	2.000 x 1.000 x 500	180	27,54	141,01
1303653	458100025201035	Maderclick Plus 5/300	2.000 x 1.000 x 300	150	24,04	97,58
1303654	458100025201045	Maderclick Plus 5/400	2.000 x 1.000 x 400	150	28,32	107,04
1303655	458100025201055	Maderclick Plus 5/500	2.000 x 1.000 x 500	150	32,59	119,66
1303658	458100045201848	Simontaller St 1804-4 Chipboard	2.000 x 1.800 x 450	600	65,12	262,08
1303659	458100045201868	Simontaller St 1806-4 Chipboard	2.000 x 1.800 x 600	600	75,80	297,03
1303660	458100045201898	Simontaller St 1809-4 Chipboard	2.000 x 1.800 x 900	600	97,16	389,60

Estantería sin tornillos



Ref.	Código	Color	Dimensiones mm	Capacidad de carga por estante	Peso kg	€/ u.
21103027	442100024188035	AZUL/BLANCO	1800x800x300	150	18,39	100,88
21103028	457100024188035	AZUL/NARANJA/GALVA	1800x800x300	150	18,39	95,12
21103029	447100024188035	AZUL/GALVA	1800x800x300	150	18,39	95,12
21103030	777100024188035	GALVA/GALVA	1800x800x300	150	18,39	95,12
21103031	333100024188035	GRIS/GRIS	1800x800x300	150	18,39	100,88
21103032	222100024188035	BLANCO/BLANCO	1800x800x300	150	18,39	100,88

Estantería sin tornillos



Ref.	Código	Color	Dimensiones mm	Capacidad de carga por estante	Peso kg	€/ u.
21103033	442100024189035	AZUL/BLANCO	1800x900x300	150	19.81	106,28
21103034	457100024189035	AZUL/NARANJA/GALVA	1800x900x300	150	19.81	102,23
21103035	447100024189035	AZUL/GALVA	1800x900x300	150	19.81	102,23
21103036	777100024189035	GALVA/GALVA	1800x900x300	150	19.81	102,23
21103037	333100024189035	GRIS/GRIS	1800x900x300	150	19.81	106,28
21103038	222100024189035	BLANCO/BLANCO	1800x900x300	150	19.81	106,28
21103039	222109024189035	BLANCO/BLANCO	1800x900x300	150	20.69	122,65

Estantería sin tornillos



Ref.	Código	Color	Dimensiones mm	Capacidad de carga por estante	Peso kg	€/ u.
21103040	442100024201035	AZUL/BLANCO	2000x1000x300	150	21.82	116,64
21103041	447100024201035	AZUL/GALVA	2000x1000x300	150	21.82	112,17
21103042	777100024201035	GALVA/GALVA	2000x1000x300	150	21.82	112,17
21103043	333100024201035	GRIS/GRIS	2000x1000x300	150	21.82	116,64
21103044	222100024201035	BLANCO/BLANCO	2000x1000x300	150	21.82	116,64
21103045	222109024201035	BLANCO/BLANCO	2000x1000x300	150	22.7	135,00



Estantería sin tornillos



Ref.	Código	Color	Dimensiones mm	Capacidad de carga por estante	Peso kg	€/ u.
21103046	442100024188045	AZUL/BLANCO	1800x800x400	150	20.77	111,69
21103047	457100024188045	AZUL/NARANJA/GALVA	1800x800x400	150	20.77	107,17
21103048	447100024188045	AZUL/GALVA	1800x800x400	150	20.77	107,17
21103049	777100024188045	GALVA/GALVA	1800x800x400	150	20.77	107,17
21103050	333100024188045	GRIS/GRIS	1800x800x400	150	20.77	111,69
21103051	222100024188045	BLANCO/BLANCO	1800x800x400	150	20.77	111,69

Estantería sin tornillos



Ref.	Código	Color	Dimensiones mm	Capacidad de carga por estante	Peso kg	€/ u.
21103052	442100024189045	AZUL/BLANCO	1800x900x400	150	22.43	121,33
21103053	457100024189045	AZUL/NARANJA/GALVA	1800x900x400	150	22.43	115,46
21103054	447100024189045	AZUL/GALVA	1800x900x400	150	22.43	115,46
21103055	777100024189045	GALVA/GALVA	1800x900x400	150	22.43	115,46
21103056	333100024189045	GRIS/GRIS	1800x900x400	150	22.43	121,33
21103057	222100024189045	BLANCO/BLANCO	1800x900x400	150	22.43	121,33
21103058	222109024189045	BLANCO/BLANCO	1800x900x400	150	23.31	137,30

Estantería sin tornillos



Ref.	Código	Color	Dimensiones mm	Capacidad de carga por estante	Peso kg	€/ u.
2402764	8425437076855	AZUL/NARANJA/GALVA	2000x1200x300	200	27.38	136,78
2402765	8425437076916	AZUL/NARANJA/GALVA	2000x1200x400	200	30.93	154,65
2402766	8425437076978	AZUL/NARANJA/GALVA	2000x1200x500	200	34.47	172,47
2402767	8435104937334	AZUL/NARANJA/MADERA	2000x1100x400	200	33.77	122,88
2402768	8435104937372	AZUL/NARANJA/MADERA	2000x1100x500	200	38.68	137,71
2402769	8425437077470	AZUL/NARANJA/MADERA	2000x1200x300	200	30.73	118,46
2402770	8425437077524	AZUL/NARANJA/MADERA	2000x1200x400	200	36.04	130,32
2402771	8425437077579	AZUL/NARANJA/MADERA	2000x1200x500	200	41.34	146,30
2402772	8425437077777	AZUL/NARANJA/MADERA	2000x1100x300	200	28.86	111,70

Estantería sin tornillos media carga



Estantería metálica sin tornillos de color AZUL/NARANJA/GALVA con capacidad de carga por estante de 200 kg. La única estantería que permite poner las bandejas en tres posiciones diferentes.



Ref.	Código	Color	Dimensiones mm	Capacidad de carga por estante	Peso kg	€/ u.
2402799	8435104921586	AZUL/NARANJA/MADERA	2000x1500x450	400	49.84	198,28
2402800	8435104921593	AZUL/NARANJA/MADERA	2000x1500x600	400	58.85	228,90
2402801	8435104991411	AZUL/NARANJA/MADERA	2000x1500x750	400	67.85	270,24
2402802	8435104921609	AZUL/NARANJA/MADERA	2000x1800x450	400	57.37	226,46
2402803	8435104921616	AZUL/NARANJA/MADERA	2000x1800x600	400	67.79	261,25
2402804	8435104991435	AZUL/NARANJA/MADERA	2000x1800x750	400	78.22	309,19
2402805	8435104925195	AZUL/NARANJA/MADERA	2000x1800x450	600	65.32	262,08
2402806	8435104920947	AZUL/NARANJA/MADERA	2000x1800x600	600	75.75	297,03
2402807	8435104990636	AZUL/NARANJA/MADERA	2000x1800x750	600	86.18	345,23
2402808	8435104920961	AZUL/NARANJA/MADERA	2000x1800x900	600	98.19	389,60
2402809	8435104925232	AZUL/NARANJA/MADERA	2000x2400x450	400	83.94	345,49
2402810	8435104925256	AZUL/NARANJA/MADERA	2000x2400x600	400	97.52	395,20
2402811	8435104990650	AZUL/NARANJA/MADERA	2000x2400x750	400	111.32	427,25
2402812	8435104925270	AZUL/NARANJA/MADERA	2000x2400x900	400	126.9	501,29



Estantería con tornillos



Ref.	Código	Color	Dimensiones mm	Capacidad de carga por estante	Peso kg	€/ u.
21103000	202100015909033	BLANCO	900x900x300	75	6.52	50,13
21103001	303100015909033	GRIS	900x900x300	75	6.52	50,13
21103002	707100015909033	GALVANIZADO	900x900x300	75	6.52	44,94
21103003	202100015909043	BLANCO	900x900x400	75	7.68	56,84
21103004	303100015909043	GRIS	900x900x400	75	7.68	56,84
21103005	707100015909043	GALVANIZADO	900x900x400	75	7.68	50,30
21103006	202100015189035	BLANCO	1800x900x300	75	11.58	77,38
21103007	303100015189035	GRIS	1800x900x300	75	11.58	77,38
21103008	707100015189035	GALVANIZADO	1800x900x300	75	11.58	67,05
21103009	202100015189045	BLANCO	1800x900x400	75	13.5	95,11
21103010	303100015189045	GRIS	1800x900x400	75	13.5	95,11
21103011	707100015189045	GALVANIZADO	1800x900x400	75	13.5	84,06
21103012	202100015201035	BLANCO	2000x1000x300	75	12.8	88,24
21103013	303100015201035	GRIS	2000x1000x300	75	12.8	88,24
21103014	707100015201035	GALVANIZADO	2000x1000x300	75	12.8	78,60

Estantería con tornillos



Ref.	Código	Color	Dimensiones mm	Capacidad de carga por estante	Peso kg	€/ u.
21103015	202100014189055	BLANCO	1800x900x500	100	18.73	113,37
21103016	303100014189055	GRIS	1800x900x500	100	18.73	113,37
21103017	707100014189055	GALVANIZADO	1800x900x500	100	18.73	108,22
21103018	202100014201035	BLANCO	2000x1000x300	100	15.6	95,29
21103019	303100014201035	GRIS	2000x1000x300	100	15.6	95,29
21103020	707100014201035	GALVANIZADO	2000x1000x300	100	15.6	91,66
21103021	202100014201045	BLANCO	2000x1000x400	100	18.14	109,87
21103022	303100014201045	GRIS	2000x1000x400	100	18.14	109,87
21103023	707100014201045	GALVANIZADO	2000x1000x400	100	18.14	105,22
21103024	202100014201055	BLANCO	2000x1000x500	100	20.69	124,21
21103025	303100014201055	GRIS	2000x1000x500	100	20.69	124,21
21103026	707100014201055	GALVANIZADO	2000x1000x500	100	20.69	118,50

Perfil para estantería, sistema de tornillos SIMONCLASSIC



Ref. Pintado Gris oscuro	Código Pintado Gris oscuro	€/ u.	Ref. Galvanizado	Código Galvanizado	€/ u.	Ref. Pintado Blanco	Código Pintado Blanco	€/ u.	Longitud mm	Para perfil mm
1303900	30113520016	7,02	1304000	70113520015	7,23	1304020	20113520016	7,02	2.000	35
1303904	30114020017	9,15	1304004	70114020018	10,04	1304024	20114020017	9,15	2.000	40
1303901	30113525016	8,79	1304001	70113525015	9,00	1304021	20113525016	8,79	2.500	35
1303905	30114025017	11,44	1304005	70114025018	12,53	1304025	20114025017	11,44	2.500	40
1303902	30113530016	10,56	1304002	70113530015	10,82	1304022	20113530016	10,56	3.000	35
1303906	30114030017	13,73	1304006	70114030018	15,03	1304026	20114030017	13,73	3.000	40
1303903	30113540016	14,09	1304003	70113540015	14,40	1304023	20113540016	14,09	4.000	35
1303907	30114040017	18,25	1304007	70114040018	20,02	1304027	20114040017	18,25	4.000	40

Bandeja metálica



Ref. Pintado Gris oscuro	Código Pintado Gris oscuro	€/ u.	Ref. Galvanizado	Código Galvanizado	€/ u.	Ref. Pintado Blanco	Código Pintado Blanco	€/ u.	Medidas mm
1304061	30126003007	7,44	1304201	70126003007	7,18	1304331	20126003007	7,44	600 x 300
1304062	30126004007	9,36	1304202	70126004007	9,10	1304332	20126004007	9,36	600 x 400
1304063	30126005008	12,64	1304203	70126005008	12,43	1304333	20126005008	12,64	600 x 500
1304066	30128003007	9,62	1304206	70128003007	9,31	1304334	20128003007	9,62	800 x 300
1304067	30128004007	12,12	1304207	70128004007	11,75	1304335	20128004007	12,12	800 x 400
1304068	30128005008	16,38	1304208	70128005008	16,07	1304336	20128005008	16,38	800 x 500
1304111	30121003007	11,75	1304211	70121003007	11,44	1304337	20121003007	11,75	1.000 x 300
1304112	30121004007	14,87	1304212	70121004007	14,40	1304338	20121004007	14,87	1.000 x 400
1304113	30121005008	20,07	1304213	70121005008	19,71	1304339	20121005008	20,07	1.000 x 500
1304115	30121202007	10,30	1304215	70121202007	10,18	1304340	20121202007	10,30	1.200 x 200
1304116	30121203007	13,94	1304216	70121203007	13,52	1304341	20121203007	13,94	1.200 x 300
1304117	30121204007	17,63	1304217	70121204007	17,11	1304342	20121204007	17,63	1.200 x 400
1304118	30121205008	23,82	1304218	70121205008	23,35	1304343	20121205008	23,82	1.200 x 500

Accesorios escuadras Simonclassic



Ref.	Código	Descripción	€/ u.
1308000	90130000019	Bolsa 8 escuadras galvanizadas	4,90
1308001	90130000020	Bolsa 8 escuadras blancas	10,10
1308002	90130000021	Caja 48 escuadras galvanizadas	14,52
1308003	90130000022	Caja 48 escuadras blancas	39,65
1308004	90130000023	Caja 100 escuadras galvanizadas	23,92
1308005	90130000024	Caja 100 escuadras blancas	77,10



Accesorios tornillos + tuercas



Ref.	Código	Descripción	€/ u.
1308100	90130000027	Blister 40 tornillos + tuercas	6,80
1308101	90130000028	Caja 200 unids. M8 x 15 galvanizadas	29,16
1308102	90130000029	Bolsa 40 tornillos + tuercas + 4 pies grises	7,24



Accesorios pies de plástico + bandejas + pies. Gris



Ref.	Código	Descripción	Para perfil mm	€ / u.
1308180	90130000002	Blister 4 pies P/35	35	2,12
1308181	90130000004	Blister 4 pies P/40	40	2,27
1308182	90130000005	Caja 48 pies P/35	35	12,82
1308183	90130000007	Caja 100 pies P/35	35	24,48
1308184	90130000009	Caja 48 pies P/40	40	14,63
1308185	90130000011	Caja 100 pies P/40	40	25,14
1308186	90130000013	Caja 48 pies dobles P/35	35	32,27
1308187	90130000015	Caja 48 pies dobles P/40	40	245,25



Accesorios pies de plástico + bandejas + pies. Blanco



Ref.	Código	Descripción	Para perfil mm	€ / u.
1308190	90130000001	Blister 4 pies P/35	35	2,12
1308191	90130000003	Blister 4 pies P/40	40	2,27
1308192	90130000006	Caja 48 pies P/35	35	12,82
1308193	90130000008	Caja 100 pies P/35	35	24,48
1308194	90130000010	Caja 48 pies P/40	40	13,13
1308195	90130000012	Caja 100 pies P/40	40	25,14



Accesorios Classiclip



Sustituye a los tornillos.

Ref.	Código	Descripción	€ / u.
1308200	90130000030	Blister 12 classiclips	9,26
1308201	90130000031	Caja 100 classiclips	53,71



Escalera doméstica en aluminio RUBIK



Ref.	Código	Denominación	Peso kg.	€ / u.
2402813	11471607	RUBIK 2	3,4	70,97
2402814	11471608	RUBIK 3	4,6	92,02
2402815	11471609	RUBIK 4	5,9	110,36
2402816	11471611	RUBIK 5	7,1	161,01
2402817	11471612	RUBIK 6	9,3	182,48



Escalera doméstica aluminio



Ref.	Código	Denominación	Peso kg.	€ / u.
8000345	11471604	DOMUS4	5,1	106,90
8000346	11471605	DOMUS5	6	124,00
8000347	11471606	DOMUS6	7,25	140,53



Escalera articulada multiusos ema-3 - con plataforma



Ref.	Código	Denominación	Peso kg.	€ / u.
2402818	11470030	EMA-3	15.2	180,77



Plataforma de trabajo POCKET



Ref.	Código	Denominación	Dimensiones cm.	Peso kg.	€ / u.
2402819	11471661	POCKET	86x30x46	7.2	173,59



Escaleras EURO



Escaleras de 1, 2 y 3 tramos transformables, trabajan en posición de tijera o apoyo a pared. Indicadas para uso profesional, están certificadas según la normativa europea de seguridad EN 131. Incluyen ruedas de deslizamiento. Disponibles extensibles con cuerda y en otras medidas. Las escaleras de un tramo de más de 3m en apoyo vienen con estabilizador, excepto la de 8 peldaños.



Ref.	Código	N° de tramos y peldaños	Longitud cerrada m	Altura en tijera m	Longitud extendida m	Ancho escalera cm	Dimensiones del perfil mm	Peso kg	€ / u.
700150	E18	1 x 8	2,32	-	-	42	57 x 27	4	91,00
700151	E112	1 x 12	3,42	-	-	42	57 x 27	8	108,00
700152	E116	1 x 16	4,57	-	-	42	67 x 27	11	158,00
700153	E120	1 x 20	5,67	-	-	42	84 x 27	14	224,00
700154	E28	2 x 8	2,4	2,3	4,06	48 / 42	57 x 27	11	257,00
700155	E210	2 x 10	3	2,9	4,9	48 / 42	57 x 27	13	299,00
700156	E212	2 x 12	3,5	3,4	6,02	48 / 42	67 x 27	16	360,00
700157	E214	2 x 14	4,1	4	7,15	48 / 42	67 x 27	20	444,00
700158	E216	2 x 16	4,6	4,5	8,3	48 / 42	100 x 27	26	681,00
700159	E36	3 x 6	1,8	1,7	4,1	48 / 42 / 36	57 x 27	12	308,00
700160	E38	3 x 8	2,4	2,3	5,75	48 / 42 / 36	67 x 27	17,50	587,00
700161	E312	3 x 12	3,5	3,4	8,55	48 / 42 / 36	84 x 27	26,50	598,00
700162	E316	3 x 16	4,6	4,5	11,9	48 / 42 / 36	115 x 27	40,00	992,00

Escalera REGINA



Escalera de tijera peldaño ancho de 80 mm de profundidad, incluye plataforma, guardacuerpo, bandeja porta-herramientas.

Ref.	Código	Nº de peldaños	Altura a plataforma m	Ancho en la base cm	Altura máx. trabajo m	Peso kg	€ / u.
700165	REG4	4	0,92	47	2,96	5,20	185,00
700166	REG5	5	1,16	49	3,2	6,00	206,00
700167	REG6	6	1,39	51	3,43	6,60	224,00
700168	REG7	7	1,61	54	3,66	7,80	248,00
700169	REG8	8	1,85	57	3,89	8,80	282,00
700170	REG10	10	2,3	62	4,35	10,60	349,00
700171	REG12	12	2,77	67	4,8	12,80	413,00



Escalera con plataforma DOUBLE DECKER



La DD es la escalera profesional de peldaño ancho que ofrece las mejores soluciones al usuario. Nueva Smartbox para dejar las herramientas, plataforma con protección de goma, peldaño de doble ancho, zapatas de goma anti-deslizantes y código QR en la etiqueta de producto y homologación. EN 131 y 5 años de garantía.



Ref.	Código	Peldaños	Descripción	Ancho escalera m	Longitud escalera cerrada m	Altura abierta m	Altura de trabajo m	Peso kg	€ / u.
1308510	502103	3	Escalera con plataforma Double Decker D803	0,47	1,40	0,60	2,60	3,8	108,00
1308511	502104	4	Escalera con plataforma Double Decker D804	0,49	1,60	0,80	2,85	4,4	123,00
1308512	502105	5	Escalera con plataforma Double Decker D805	0,52	1,85	1,05	3,05	5,0	138,00
1308513	502106	6	Escalera con plataforma Double Decker D806	0,54	2,05	1,25	3,25	6,1	158,00
1308514	502107	7	Escalera con plataforma Double Decker D807	0,56	2,30	1,45	3,45	7,2	182,00
1308515	502108	8	Escalera con plataforma Double Decker D808	0,60	2,55	1,70	3,70	8,4	206,00

Escalera con plataforma LIMA



La Lima es una escalera profesional de peldaño ancho muy ligera que ofrece las mejores soluciones al usuario. Incluye bandeja porta objetos, 5 años de garantía.



Ref.	Código	Peldaños	Descripción	Ancho escalera m	Altura abierta m	Altura de trabajo m	Peso kg	€ / u.
21009000	508604	4	Escalera con plataforma Lima L604	0,46	0,8	2,8	4,5	95,00
21009001	508605	5	Escalera con plataforma Lima L605	0,49	1,05	3,05	5	110,00
21009002	508606	6	Escalera con plataforma Lima L606	0,52	1,25	3,25	6,3	136,00

Escalera BRENTA

altrex

Escalera de peldaño de 38 cm de ancho anti-deslizante, es plegable, tiene ruedas de desplazamiento y bandeja porta-objetos. Es el producto ideal para el picking en almacenes.



Ref.	Código	Peldaños	Descripción	Longitud plegada m	Altura de plataforma m	Máx. altura de trabajo en un solo tramo m	Peso kg	€ / u.
715440	503002	2	Brenta 2	0,80	0,45	2,45	6,8	228,00
715441	503003	3	Brenta 3	1,10	0,70	2,70	9,1	290,00
715442	503004	4	Brenta 4	1,40	0,90	2,90	11,3	338,00

Escalera TME

altrex

Escalera de picking plegable, con ruedas de transporte y barandillas de protección. Es única en el mercado, práctica y cómoda de usar. EN 131 y 10 años de garantía



Ref.	Código	Peldaños	Descripción	Anchura m	Altura plataforma m	Altura trabajo m	Dimensiones plataforma	Peso kg	€ / u.
715445	193206	6	Escalera de almacén TME 6	0,61	1,40	3,40	0,30x0,33	16,0	695,00
715446	193207	7	Escalera de almacén TME 7	0,64	1,65	3,65	0,30x0,33	18,0	732,00
715447	193209	9	Escalera de almacén TME 9	0,70	2,10	4,10	0,30x0,33	23,6	836,00
715448	193211	11	Escalera de almacén TME 11	0,76	2,60	4,60	0,30x0,33	27,1	940,00

Escalera CASTELLANA MAXI

svelt

Escalera de almacén industrial muy robusta con peldaños soldados. Amplia plataforma, ruedas y barandillas. Se pliega facilitando el almacenaje.

Ref.	Código	Nº de peldaños	Altura a plataforma m	Peso	Peso kg	€ / u.
700175	CATM4	4	0,92	31	31,00	1.614,00
700176	CATM6	6	1,38	37	37,00	1.816,00
700177	CATM8	8	1,84	44	44,00	2.233,00
700178	CATM10	10	2,3	50	50,00	2.467,00
700179	CATM12	12	2,76	58	58,00	2.854,00
700180	CATM14	14	3,22	67	67,50	3.257,00



Escalera de tijera ELEGANCE



El modelo ELEGANCE está fabricado en aluminio, con montantes con perfiles estriados, peldaños de 13 cm. fijados con remaches de acero de gran resistencia, posee un sistema de refuerzos en zonas vulnerables que dotan al modelo de una gran estabilidad, tarima de acero antideslizante de 27x27 cm. y una amplia bandeja portaobjetos. Este producto cumple con la normativa europea EN 131-1,2,3 y se entrega junto con el certificado de conformidad y el manual de instrucciones, la carga máxima que aguanta es de 150 kg.



Ref.	Código	Nº Peldaños	Altura Plataforma cm	Altura trabajo cm	Peso Kgr.	€/ u.
8002203	EN 943	3	65	245	4,5	140,00
8002204	EN 944	4	86	266	5	160,00
8002205	EN 945	5	107	287	6	185,00
8002206	EN 946	6	130	310	7	220,00
8002207	EN 947	7	151	331	8	240,00
8002208	EN 948	8	172	352	9	270,00

Escalera multiuso



Escalera multiuso profesional todo aluminio. Bisagra en acero automáticas con dispositivo de seguridad bloqueo Cómodo y rápido cambio de posición. Ganchos macizos con tope. EN 131-1-2 150 kg



Ref.	Código	Modelo	Descripción	€/ u.
8004814	11471420	5X5 SINEX	Escalera multiuso todo aluminio. Bisagra automática de bloqueo, sistema cómodo, seguro y rápido. 8+8 peldaños. Permite trabajos a distinto nivel. Muy robusta, resistente y versátil. Medidas máximas en tijera 2,03 m. Medidas máximas un solo tramo 4,16 m. Medida recogida 128 cm. Peso 15 Kg. Certificación EN-131-4. Resistencia 150 kg.	282,00
8004815	11471430	6X6 SINEX		342,00
715482	11471410	4X4 SINEX		402,00

Escalera Telescópica VARITREX TELEFLEX

altrex



Ref.	Código	Denominación	Peldaños	Altura plegada m.	Desplegada m.	Máx altura en posición un solo tramo apoyo pared m.	Máx altura en posición combinada m.	Peso Kg	€ / u.
8002062	503750	Varitrex-Teleflex	4x4	1,15	3,9	4,9	2,85	11	292,00

Escalera Telescópica VARITREX PLUS

altrex



Ref.	Código	Denominación	Peldaños	(m) plegada	Desplegada m.	(m) max altura en posición un solo tramo apoyo pared	Máx altura en posición combinada m.	Peso Kg	€ / u.
8002063	503538	Varitrex-Plus	4x3	0,9	3,4	4,3	3	13,5	265,00

Escalera ESCALISIMA

svelt

Escalera telescópica y multiposiciones: posición de tijera, en apoyo a pared y desnivel. Sicurkit: Plataforma fabricada en aluminio antideslizante, con guardacuerpo de 60cm o de 100cm, lo que permite al operario subirse al último peldaño con seguridad.

Ref.	Código	Longitud cerrada m	Altura tijera m	Longitud extendida m	Peso kg	€ / u.
701190	ESC6	0,97	1,46	3,00	9,20	268,00
2402820	ESC8E	1,25	1,96	4,1	11	367,00
701192	ESC10	1,53	2,51	5,22	13,20	376,00
701193	ESC12	1,81	3,10	6,35	15,00	420,00



08

Escalera VARITREX TELEPROF



La TP es la única escalera telescópica del mercado con botón de apertura y cierre automático, es lacada para una mayor protección del aluminio, zapatas de goma anti-deslizantes y RED ALTREX STEP que indica el último peldaño practicable. Certificada EN 131 y 10 años de garantía.



Ref.	Código	Peldaños	Descripción	Longitud desplegada m	B m	C m	A m	Peso kg	€ / u.
715455	503754	4 x 4	Varitrex Teleprof 4x4	1,25	4,10	5,00	2,85	12,0	465,00
715456	503755	4 x 5	Varitrex Teleprof 4x5	1,60	5,10	6,00	3,35	16,0	581,00

Escalera TELEFLY



Escalera telescópica de castillo con peldaño ancho, plataforma regulable en altura y guardacuerpo de protección de 360°. Barandilla plegables de 100cm de altura y estabilizadores telescópicos que permiten estabilizar la escalera en cualquier tipo de superficie, en suelos desnivelados y en apoyo en pared. Fabricado conforme a la normativa EN-131-1/2/7.



Ref.	Código	Nº de peldaños	Altura total cerrada m	Altura Min. Plat. M	Altura Max. Plat. M	Altura Máx. trabajo	Peso kg	€ / u.
21113000	TFL4	4	2.26	1	1.5	3.5	28	1.284,00
21113001	TFL5	5	2.54	1.25	1.75	3.75	31	1.338,00
21113002	TFL6	6	2.82	1.5	2	4	34	1.454,00

Escalera TELEFLY LIGHT



Escalera de plataforma regulable en altura, con dimensiones 57x44 cm.



Ref.	Código	Nº de peldaños	Altura total cerrada m	Altura Min. Plat. M	Altura Max. Plat. M	Altura Máx. trabajo	Peso kg	€ / u.
21113003	TFL4	4	2.15	1	1.52	3.52	17.5	887,00
21113004	TFL6	6	2.73	1.52	2.32	4.32	20.5	1.053,00

Escalera Cargo Plus



Taburete de aluminio con estructura muy resistente. Plataforma amplia y peldaños de 20cm de profundidad. Se diseña y fabrica a medida, por lo que permite modificación en sus dimensiones y adicionar accesorios como ruedas y barandillas.



Ref.	Código	N° de tramos y peldaños	Altura de plataforma m	Altura de trabajo m	Ancho escalera cm	Peso	Dimensiones del perfil mm	€/ u.
8001536	CARP1	1	0,24	2,24	50	23,00	50 x 60	620,00
8001537	CARP2	2	0,48	2,48	50	25,00	50 x 60	775,00
8001538	CARP3	3	0,72	2,72	50	27,00	50 x 60	820,00
8001539	CARP4	4	0,96	2,96	50	29,00	50 x 60	870,00

Torreta



Escalera de aluminio de castillo con plataforma, guardacuerpo y barandilla de 1m de altura. Se puede equipar con salida frontal o lateral, con cierre o puerta de seguridad en la salida y voladizo. Disponible también con plataforma y peldaños en Tramex. Se trata de un producto de fabricación especial, por lo que se intenta ajustar a las necesidades del cliente. Precios a consultar.



Ref.	Código	N° de tramos y peldaños	Altura de plataforma m	Altura de trabajo m	Altura a plataforma m	Peso	€/ u.
8001540	TOR4	4	0,92	2,92	2,92	44,00	439,00
8001541	TOR6	6	1,38	3,38	3,38	47,00	1.440,00
8001542	TOR8	8	1,85	3,85	3,85	52,00	1.560,00
8001543	TOR10	10	2,30	4,30	4,3	59,00	1.680,00
8001544	TOR12	12	2,75	4,75	4,75	66,00	1.980,00
8001545	TOR14	14	3,20	5,20	5,2	72,00	2.220,00

Escalera con amplia plataforma y altura regulable



Escalera plegable, fácil de transportar.
 Regulable en altura.
 Peldaños antideslizantes de 3 cm de profundidad.
 Plataforma antideslizante de 40x40 cm.
 Barandilla de 110 cm de altura.
 Zócalos de 15 cm de altura que evitan la caída de objetos desde el plano de trabajo.
 2 ruedas de 17 cm de diámetro
 Bolsa porta herramientas. Estabilizadores extraíbles.



Ref.	Código	Nº Peldaños	Altura de trabajo máxima	ALTURA DE TRABAJO (cm)	€ / u.
2402821	PLS3	3	310 cm.	260/310	2.460,00
2402822	PLS5	5	390 cm.	310/390	945,00

Escalera de aluminio SMT



La SMT es una escalera plegable con ruedas y amplio plano de trabajo antideslizante de 52x62 cm con acceso mediante una escalera con 60° de inclinación con peldaños antideslizantes de 15 cm de profundidad y pasamanos en ambos lados. Estructura ligera y robusta enteramente fabricada de aluminio. La SMT es una escalera generalmente utilizada en industrias y almacenes.



Ref.	Código	Nº Peldaños	Altura Plataforma cm	Altura trabajo cm	Peso Kgr.	€ / u.
8002192	SMT70	3	74	254	25	945,00
8002193	SMT100	4	98	278	27	985,00
8002194	SMT120	5	120	300	30	1.005,00
8002195	SMT150	6	146	326	32	1.095,00
8002196	SMT200	7	170	350	36	1.150,00
8002197	SMT250	8	194	374	37	1.205,00
8002198	SMT300	10	243	423	42	1.655,00
8002199	SMT350	12	292	423	47	1.775,00
8002200	SMT400	14	341	521	51	1.875,00
8002201	SMT450	15	366	546	54	1.985,00
8002202	SMT500	17	415	595	58	2.095,00

Andamio ROLLER PLUS L



Andamio modular de aluminio de 50mm de diámetro. Su base plegable hace más fácil y rápido su montaje. Las plataformas son de madera con tratamiento especial para la intemperie. El acceso es por el interior, usando los marcos laterales a modo de escaleras.



Ref.	Código	Altura máxima a plataforma m	Alto	Altura estimada de trabajo m	Estabilizadores	N° plataformas	€ / u.
21113005	ROLERPLA	0.9	1.70	2.90	NO	1	932,00

Andamio ROLLER PLUS S



Andamio modular de aluminio de 50mm de diámetro. Su base plegable hace más fácil y rápido su montaje. Las plataformas son de madera con tratamiento especial para la intemperie. El acceso es por el interior, usando los marcos laterales a modo de escaleras.



Ref.	Código	Altura máxima a plataforma m	Alto	Altura estimada de trabajo m	Estabilizadores	N° plataformas	€ / u.
21113020	ROLERPSA	0.9	1.70	2.90	NO	1	769,00

Andamio TARGET



Andamio telescópico multiposiciones. Laterales de aluminio y crucetas de acero. Transformable en 2 escaleras que se pueden usar de forma independiente tanto en posición tijera como apoyo.

Ref.	Código	Dimensión andamio m	Altura máxima a plataforma m	Altura de trabajo m	Peso kg	€/ u.
700183	TARGET	1,85 x 1	2,51	4,51	48	920,00



Andamio simple 2x6 convertible



Ref.	Código	Denominación	Alto cm	Altura de trabajo m	Nº Plataformas	Peso kg.	€/ u.
2402823	11471500	ANDAMIO SIMPLE 2X6	160	2,6	1	15,8	335,85



Andamio rapido 160



Altura de estructura disponible desde 2 m. hasta 6 m.
Estabilizadores laterales.
4 ruedas de 12,5 cm. con freno.
Plataforma de 160x80 cm. de superficie. Hueco de la trampilla de 60x58 cm.
Contrapesos opcionales de 15 kg/unidad para aumentar la estabilidad.



Sistema de plegado RCI160.
Este sistema hace que no tengamos que desmontar por completo el andamio.



Ref.	Código	Descripción	Altura total de la estructura	ALTURA DE TRABAJO (cm)	ALTURA TOTAL (cm)	ALTURA MÁX. POSICIÓN DE TRABAJO (cm)	ALTURA PLATAFORMA (cm)	€ / u.
2402824	RAPIDO160-H200CM	RAPIDO 160 Andamio de aluminio con ruedas y plataforma de 160x80 cm.	200CM	400	200	400	200	860,00
2402825	RAPIDO160-H300CM	RAPIDO 160 Andamio de aluminio con ruedas y plataforma de 160x80 cm.	300CM	400	300	400	200	1.100,00
2402826	RAPIDO160-H400CM	RAPIDO 160 Andamio de aluminio con ruedas y plataforma de 160x80 cm.	400CM	500	400	500	300	1.707,00
2402827	RAPIDO160-H500CM	RAPIDO 160 Andamio de aluminio con ruedas y plataforma de 160x80 cm.	500CM	600	500	600	400	1.947,00
2402828	RAPIDO160-H600CM	RAPIDO 160 Andamio de aluminio con ruedas y plataforma de 160x80 cm.	600CM	700	600	700	500	2.522,00
2402829	RAPIDO160-H700CM	RAPIDO 160 Andamio de aluminio con ruedas y plataforma de 160x80 cm.	700CM	800	700	800	600	2.762,00

Módulo base para andamio RAPIDO 160



Módulo base para andamio RAPIDO 160 con:

Laterales, travesaños y diagonales.
Plataforma.
Sistema de pliego.
RUEDAS DE 12,5 cm. INCLUIDAS



Ref.	Código	€ / u.
2402830	PACK-160-1	860,00
2402831	PACK-160-2	847,00
2402832	PACK-160-3	815,00
2402833	PACK-160-4	240,00

TORRE MÓVIL RS TOWER 34



Torre móvil de aluminio RS TOWER 34 módulo 1. Ancho 0.75m; te permitirá pasar por cualquier puerta y llegar a una altura de trabajo de 3m. Ligero, plegable y compacto. La estructura modular de este andamio está compuesta de 4 módulos (1+2+3+3) que alcanzan una altura de trabajo total de 7.80m.



Ref.	Código	Ancho plataforma (m)	Longitud plataforma (m)	Altura de plataforma (m)	Altura de plataforma (m)	Altura de trabajo (m)	€/ u.
15000079	503441	0,75	1,65	1,00	1,00	3,00	906,00
15000080	503442	0,75	1,65	1,80	1,80	3,80	1.068,00
15000081	503443	0,75	1,65	3,80	3,80	5,80	1.068,00

TORRE MÓVIL ANCHO SIMPLE



Torre móvil de aluminio estrecha de 75x190cm y altura de plataforma 2.20m con sistema de barandillas ECO y tirantes horizontales y diagonales en la base. Máxima seguridad en el montaje: estable, robusto y fuerte. De peso ligero.



Ref.	Código	Ancho plataforma (m)	Longitud plataforma (m)	Altura de plataforma (m)	Altura de plataforma (m)	Altura de trabajo (m)	€/ u.
15000029	K102204	0,75	1,90	2,20	2,20	4,20	1.733,00
15000030	K102205	0,75	1,90	3,20	3,20	5,20	1.805,00
15000031	K102206	0,75	1,90	4,20	4,20	6,20	2.529,00
15000032	K102207	0,75	1,90	5,20	5,20	7,20	2.793,00
15000033	K102208	0,75	1,90	6,20	6,20	8,20	3.517,00
15000034	K102209	0,75	1,90	7,20	7,20	9,20	3.589,00
15000035	K102210	0,75	1,90	8,20	8,20	10,20	4.313,00

TORRE MÓVIL ANCHO SIMPLE



Torre móvil de aluminio estrecha de 75x250cm y altura de plataforma 2.20m con sistema de barandillas ECO y tirantes horizontales y diagonales en la base. Máxima seguridad en el montaje: estable, robusto y fuerte. De peso ligero.

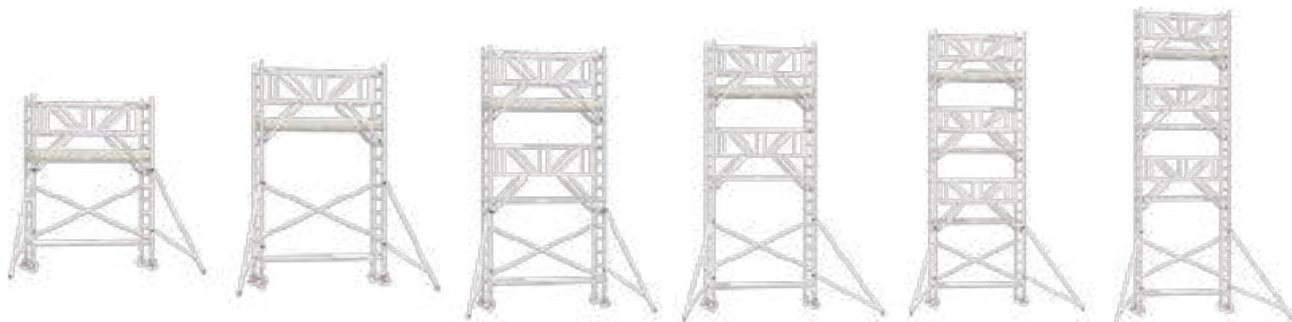

Ref.	Código	Ancho plataforma (m)	Longitud plataforma (m)	Altura de plataforma (m)	Altura de plataforma (m)	Altura de trabajo (m)	€ / u.
15000036	K102211	0,75	2,50	2,20	2,20	4,20	1.857,00
15000037	K102212	0,75	2,50	3,20	3,20	5,20	1.929,00
15000038	K102213	0,75	2,50	4,20	4,20	6,20	2.724,00
15000039	K102214	0,75	2,50	5,20	5,20	7,20	2.988,00
15000040	K102215	0,75	2,50	6,20	6,20	8,20	3.783,00
15000041	K102216	0,75	2,50	7,20	7,20	9,20	3.855,00
15000042	K102217	0,75	2,50	8,20	8,20	10,20	4.650,00

TORRE MÓVIL ANCHO SIMPLE



Torre móvil de aluminio estrecha de 90x190cm y altura de plataforma 2.20m con sistema de barandillas ECO y tirantes horizontales y diagonales en la base. Máxima seguridad en el montaje: estable, robusto y fuerte. De peso ligero.

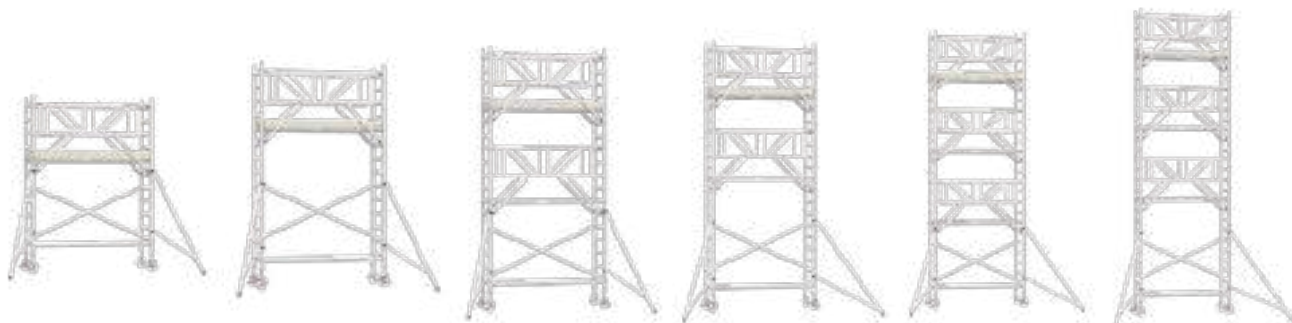

Ref.	Código	Ancho plataforma (m)	Longitud plataforma (m)	Altura de plataforma (m)	Altura de plataforma (m)	Altura de trabajo (m)	€ / u.
15000043	K102218	0,90	1,90	2,20	2,20	4,20	1.761,00
15000044	K102219	0,90	1,90	3,20	3,20	5,20	1.841,00
15000045	K102220	0,90	1,90	4,20	4,20	6,20	2.575,00
15000046	K102221	0,90	1,90	5,20	5,20	7,20	2.847,00
15000047	K102222	0,90	1,90	6,20	6,20	8,20	3.581,00
15000048	K102223	0,90	1,90	7,20	7,20	9,20	3.661,00
15000049	K102224	0,90	1,90	8,20	8,20	10,20	4.395,00

TORRE MÓVIL ANCHO SIMPLE



Torre móvil de aluminio estrecha de 90x250cm y altura de plataforma 2.20m con sistema de barandillas ECO y tirantes horizontales y diagonales en la base. Máxima seguridad en el montaje: estable, robusto y fuerte. De peso ligero.

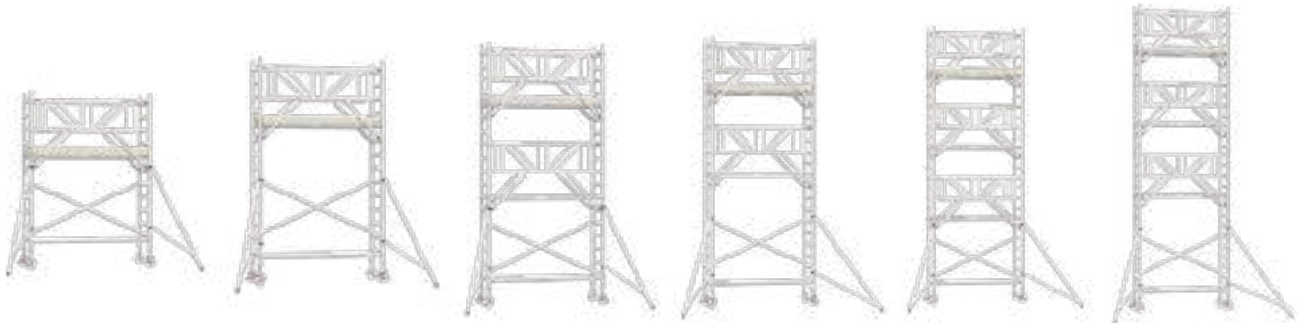

Ref.	Código	Ancho plataforma (m)	Longitud plataforma (m)	Altura de plataforma (m)	Altura de plataforma (m)	Altura de trabajo (m)	€/ u.
15000050	K102225	0,90	2,50	2,20	2,20	4,20	1.885,00
15000051	K102226	0,90	2,50	3,20	3,20	5,20	1.965,00
15000052	K102227	0,90	2,50	4,20	4,20	6,20	2.770,00
15000053	K102228	0,90	2,50	5,20	5,20	7,20	3.042,00
15000054	K102229	0,90	2,50	6,20	6,20	8,20	3.847,00
15000055	K102230	0,90	2,50	7,20	7,20	9,20	3.927,00
15000056	K102231	0,90	2,50	8,20	8,20	10,20	4.732,00

TORRE MÓVIL ANCHO DOBLE



Torre móvil de aluminio ancho doble de 135x190cm y altura de plataforma 2.20m con sistema de barandillas ECO y tirantes horizontales y diagonales en la base. Máxima seguridad en el montaje: estable, robusto y fuerte. De peso ligero.

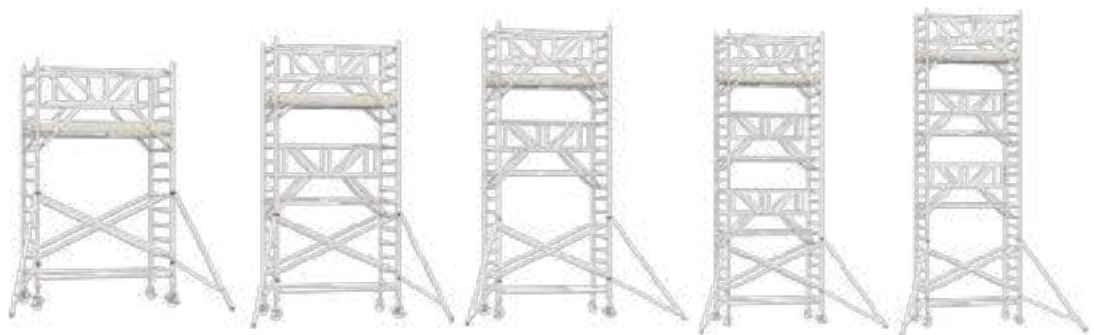

Ref.	Código	Ancho plataforma (m)	Longitud plataforma (m)	Altura de plataforma (m)	Altura de plataforma (m)	Altura de trabajo (m)	€/ u.
15000057	K102232	1,35	1,90	2,20	2,20	4,20	2.091,00
15000058	K102233	1,35	1,90	3,20	3,20	5,20	2.199,00
15000059	K102234	1,35	1,90	4,20	4,20	6,20	2.963,00
15000060	K102235	1,35	1,90	5,20	5,20	7,20	3.263,00
15000061	K102236	1,35	1,90	6,20	6,20	8,20	4.027,00
15000062	K102237	1,35	1,90	7,20	7,20	9,20	4.135,00
15000063	K102238	1,35	1,90	8,20	8,20	10,20	4.899,00
15000064	K102239	1,35	1,90	9,20	9,20	11,20	5.007,00
15000065	K102240	1,35	1,90	10,20	10,20	12,20	5.771,00
15000066	K102241	1,35	1,90	11,20	11,20	13,20	5.879,00
15000067	K102242	1,35	1,90	12,20	12,20	14,20	6.643,00

TORRE MÓVIL ANCHO DOBLE



Torre móvil de aluminio ancho doble de 135x250cm y altura de plataforma 2.20m con sistema de barandillas ECO y tirantes horizontales y diagonales en la base. Máxima seguridad en el montaje: estable, robusto y fuerte. De peso ligero.

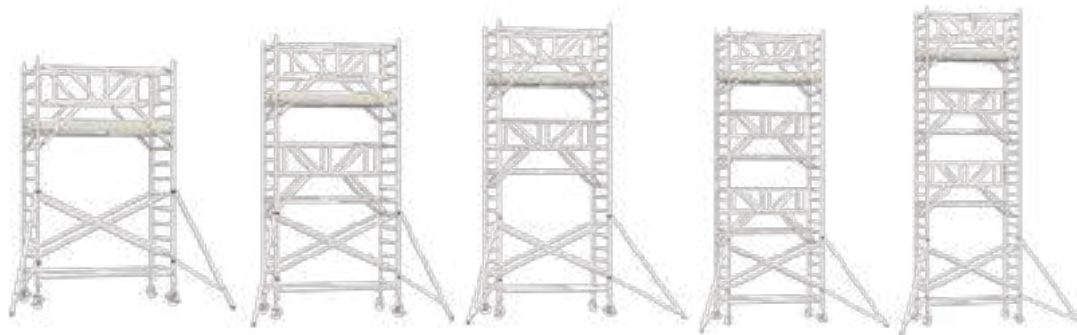

Ref.	Código	Ancho plataforma (m)	Longitud plataforma (m)	Altura de plataforma (m)	Altura de plataforma (m)	Altura de trabajo (m)	€/ u.
15000068	K102243	1,35	2,50	2,20	2,20	4,20	2.254,00
15000069	K102244	1,35	2,50	3,20	3,20	5,20	2.362,00
15000070	K102245	1,35	2,50	4,20	4,20	6,20	3.197,00
15000071	K102246	1,35	2,50	5,20	5,20	7,20	3.497,00
15000072	K102247	1,35	2,50	6,20	6,20	8,20	4.332,00
15000073	K102248	1,35	2,50	7,20	7,20	9,20	4.440,00
15000074	K102249	1,35	2,50	8,20	8,20	10,20	5.275,00
15000075	K102250	1,35	2,50	9,20	9,20	11,20	5.383,00
15000076	K102251	1,35	2,50	10,20	10,20	12,20	6.218,00
15000077	K102252	1,35	2,50	11,20	11,20	13,20	6.326,00
15000078	K102253	1,35	2,50	12,20	12,20	14,20	7.161,00

Enrollador monobrazo baja presión



Enrolladores de manguera de tipo abierto con estructura portante monobrazo realizada en aluminio y bobina en composite. Indicados para la conducción de fluidos a baja presión. Su utilización mejora el entorno y ergonomía del puesto de trabajo. Recomendado para soluciones acuosas para lavado, urea o desengrasantes.



Ref.	Código	Longitud	Ø Manguera mm	Conexión salida	Conexión entrada	Presión trabajo	€/ u.
1705125	506762	10 m	1/2"	1/2" BSP	1/2" BSP	20 bar	655,00

Enrollador monobrazo alta presión



Enrolladores de manguera de tipo abierto con estructura portante monobrazo realizada en aluminio y bobina en composite. Indicados para la conducción de fluidos a baja presión. Su utilización mejora el entorno y ergonomía del puesto de trabajo. Recomendado para soluciones acuosas para lavado, urea o desengrasantes.



Ref.	Código	Longitud	Ø Manguera mm	Conexión salida	Conexión entrada	Presión trabajo	€/ u.
1705130	506421	15 m	3/8"	3/8" BSP	3/8" BSP	170 bar	694,00

Enrollador manguera abierto alto caudal baja presión



Enrolladores de manguera de tipo abierto con estructura portante de dos brazos, realizado en acero con recubrimiento en polvo sinterizado. Indicados para la conducción de fluidos a baja presión. Su utilización mejora el entorno y ergonomía del puesto de trabajo. Recomendado para soluciones acuosas para lavado, urea o desengrasantes.

Ref.	Código	Longitud	Ø Manguera mm	Conexión salida	Conexión entrada	Presión trabajo	€ / u.
1705135	505524	15 m	3/4"	3/4" BSP	3/4" BSP	20 bar	1.400,00



Enrollador manguera abierto alto caudal media presión



Enrolladores de manguera de tipo abierto con estructura portante de dos brazos, realizado en acero con recubrimiento en polvo sinterizado. Indicados para la conducción de fluidos a baja presión. Su utilización mejora el entorno y ergonomía del puesto de trabajo. Recomendado para soluciones acuosas para lavado, urea o desengrasantes.

Ref.	Código	Longitud	Ø Manguera mm	Conexión salida	Conexión entrada	Presión trabajo	€ / u.
1705140	505232	20 m	1/2"	1/2" BSP	1/2" BSP	160 bar	1.020,00



Enrollador manguera abierto en acero inoxidable baja presión



Enrolladores de manguera multi aplicación realizados en acero inoxidable (AISI 304) que permite su utilización en ambientes corrosivos, intemperie y en la industria alimentaria. Con estructura soporte de doble brazo, los brazos son orientables para conseguir un funcionamiento óptimo en cualquier posición de montaje: mural, en techo o sobre suelo.

Ref.	Código	Descripción	Longitud	Ø Manguera mm	Conexión salida	Conexión entrada	Presión trabajo	€ / u.
1705150	503120	ENROLLADOR ABIERTO INOX EIN-20	20 m	1/2"	1/2" BSP	1/2" BSP	10 bar	1.280,00



Enrollador manguera abierto en acero inoxidable alta presión



Enrolladores de manguera multi aplicación realizados en acero inoxidable (AISI 304) que permite su utilización en ambientes corrosivos, intemperie y en la industria alimentaria. Con estructura soporte de doble brazo, los brazos son orientables para conseguir un funcionamiento óptimo en cualquier posición de montaje: mural, en techo o sobre suelo.

Ref.	Código	Longitud	Ø Manguera mm	Conexión salida	Conexión entrada	Presión trabajo	€ / u.
1705155	503400	20 m	3/8"	3/8" BSP	1/2" BSP	250 bar	1.510,00



Enrolladores de manguera compactos



Enrolladores de manguera compactos, con carena realizada en aluminio. Indicados para la conducción a baja presión de aire comprimido, nitrógeno o agua. Su utilización mejora el entorno y ergonomía del puesto de trabajo.

Ref.	Código	Longitud	Ø Manguera mm	Conexión salida	Conexión entrada	Presión trabajo	€ / u.
1706302	500115	15 m	5/16"	1/4" BSP	3/8" BSP	15 bar	280,00
1706303	500116	12 m	3/8"	3/8" BSP	3/8" BSP	16 bar	305,00



Extensible industrial



Soporte metálico. Carrete de plástico 3.500 W.

Ref.	Código	Longitud cable m	Cable	€/ u.
21104001	PCA-25	25	3 x 1,5	53,80
21104002	PCA-50	50	3 x 1,5	98,30



Extensible industrial



Soporte metálico.

Ref.	Código	Longitud cable m	Potencia máx.	Cable	Carrete mm	€/ u.
1800004	772603	25	3.500 W	3 x 1,5	230	54,57
1800005	777608	50	3.500 W	3 x 1,5	230	92,93
1800101	770500	25	3.500 W	3 x 1,5	255	118,58
1800103	775505	50	3.500 W	3 x 1,5	255	182,62
1802030	765001	25	3.500 W	3 x 1,5	290	128,31
1802031	766008	50	3.500 W	3 x 1,5	290	186,08
1802040	785511	25	4.000 W	3 x 2,5	255	186,93
1802041	786518	50	4.000 W	3 x 2,5	310	296,29



Protección para niños



250V-10/16A, potencia máxima 3.680W. Cable H05W-F3G1.514M.

Ref.	Código	Descripción	€/ u.
8000334	801600	3 bases 2P+T con interruptor	8,81
8000336	806605	4 bases 2P+T con interruptor	9,55
8000338	808609	5 bases con interruptor	10,24
8000340	811609	6 bases con interruptor	11,12



Protección sobre tensión



Bases con interruptor 3.500 W.

Ref.	Código	Bases 2P+T	Longitud cable m	Cable	€/ u.
1802100	814600	4	1,5	3 x 1,5	19,59
1802101	816604	6	1,5	3 x 1,5	21,49
1802102	818608	8	1,5	3 x 1,5	24,14



Prolongador eléctrico 2p + t



Ref.	Código	Longitud cable m	Bases	€/ u.
1800500	575006	10	3 x 1,5	26,03
1800501	576003	15	3 x 1,5	37,62
1800502	577000	25	3 x 1,5	61,75



Focos LED



Ref.	Código	Lúmenes Lm	Potencia W	Tiempo de carga h	Temperatura color k	Peso Kgr.	€ / u.
15001678	1181500	3600	50	5	6.000-7.000	2	164,00

Focos LED



Ref.	Código	Lúmenes Lm	Potencia W	Tiempo de carga h	Temperatura color k	Peso Kgr.	€ / u.
15001679	1181600	3000	30	5	6.500	1.4	124,80

Focos LED



El cuerpo del foco está fabricado de termoplástico (policarbonato) resistente al calor, y en la parte posterior tiene un radiador aleteado de aluminio especialmente diseñado para disipar el calor. Para la conexión del cable, el foco dispone de un terminal de conexiones al que se accede desatornillando la tapa posterior del foco.



Ref.	Código	Lúmenes Lm	Potencia W	Tiempo de carga h	Temperatura color k	Peso Kgr.	€ / u.
15001680	1185010	1000	10	5.5	6.500	0.85	68,80
15001681	1185020	2000	20	3.5	6.000-7.000	1	100,00

Focos LED



Asegurarse que el cable que se instale esté en correctas condiciones sin roturas ni desperfectos en el aislante, antes de conectarlo a la red. La instalación de este foco debe hacerse por personal cualificado.



Ref.	Código	Lúmenes Lm	Potencia W	Cable		Peso Kgr.	€ / u.
15001682	1184010	1000	10	No	6.500	0.4	18,82
15001683	1184030	3000	30	No	6.500	1.1	39,14
15001684	1184050	5000	50	No	6.500	2.1	56,20

Focos LED



El cuerpo del foco está fabricado de termoplástico (policarbonato) resistente al calor, y en la parte posterior tiene un radiador aleteado de aluminio especialmente diseñado para disipar el calor. Para la conexión del cable, el foco dispone de un terminal de conexiones al que se accede desatornillando la tapa posterior del foco.



Ref.	Código	Lúmenes Lm	Potencia W	Cable		Peso Kgr.	€ / u.
15001685	1184011	1000	10	No	6.500	0.4	31,50
15001686	1184031	3000	30	No	6.500	1.1	52,76

Focos LED



El cuerpo del foco está fabricado de termoplástico (policarbonato) resistente al calor, y en la parte posterior tiene un radiador aleteado de aluminio especialmente diseñado para disipar el calor. Este foco se suministra integrado en un soporte plegable con un asa ergonómico de espuma para su transporte, y con un cable de 5 metros del tipo H05RN-F 3G1.0mm2 y una clavija IP44. El soporte plegable puede inclinarse y bloquearse para direccionar la luz del foco. Gracias a su grado de protección IP65, es apto para su uso en interiores y exteriores.



Ref.	Código	Lúmenes Lm	Potencia W	Cable		Peso Kgr.	€ / u.
15001687	1184032	3000	30	Si	6.500	2.1	76,54
15001688	1184052	5000	50	Sí	6.500	3.1	97,10

Lámpara de LED

PHILIPS



Ref.	Código	Lúmens	€ / u.	Ref.	Código	Lúmens	€ / u.
2402834	2169431	200	46,53	2402837	1469631	500	94,49
2402835	1391094	200	73,18	8000282	39627066	1500/750	315,00
2402836	2173131	300	46,53	2402838	1467231	500	65,09

Lámpara de LED

PHILIPS

Ref.	Código	Lúmens	€ / u.
700292	39421431	330	64,00



Lámpara de LED

PHILIPS



Ref.	Código	Lúmens	€ / u.	Ref.	Código	Lúmens	€ / u.
2402840	1471931	500	122,46	2402843	2492331	300	33,20
2402841	1465831	300	57,14	2402844	2496131	500	39,87
2402842	1473331	300	50,47	2402845	2504331	1.000	59,87

Linterna LED



Ref.	Código	Descripción	Lúmenes	Resistencia a caídas	Resistencia agua	Alcance m	Autonomía horas	Color	Longitud mm	Diámetro	Pila Incluida	Peso	€ / u.
21071000	SJ3A012	MAGLITE® Solitaire® LED. Linterna tipo llavero de 1 pila tipo AAA-LR03.	47	2 m	IPX7	47 m	1h 45min	Negro	81 mm	12,7 mm	1xLR03	24 g	32,95
21071001	SP32012	MINI MAGLITE® LED 2 AAA. Linterna de bolsillo de 2 pilas tipo AAA-LR03	111	2 m	IPX7	104 m	2h 45min	Negro	127 mm	12,70 mm	2xLR03	49,04 g	39,95
21071002	ML25LTS3015	MAGLITE® LED ML25L™. Linternas de 3 pilas tipo C-LR14	173	1 m	IPX4	309 m	18h	Negro	218,44 mm	30,48 mm	no	408,23 g	54,95
8000329	ML50LS2015	MAGLITE® LED ML50L™. Linternas de 2 pilas tipo C-LR14	490	1 m	IPX4	299 m	15 h / 112h	Negro	207,87 mm	50,22 mm	no	360 g	109,95
8000331	ML300LS2015	MAGLITE® LED ML300L™ Linternas de 2 pilas tipo D-LR20	524	1 m	IPX4	366 m	6h 30min / 69h	Negro	231,77 mm	38,1 mm	no	566,99 g	109,95
1308683	ML300LS3016	MAGLITE® LED ML300L™ Linternas de 3 pilas tipo D-LR20	625	1 m	IPX4	406 m	16h / 117h	Negro	298,45 mm	38,1 mm	no	748,43 g	114,95
1308684	TRM4RE4	MAG-TAC® Sistema Recargable corona plana	533	2 m	IPX4	178 m	2h 30min / 4h	Negro	147,57 mm	26,67 mm	LiFePO4	155,9 g	224,95
8000332	ML150LR4019	MAGLITE® LED ML150LR Sistema Recargable	1.082	1 m	IPX4	458 m	3h 15min / 79h	Negro	271,45 mm	30,15 mm	LiFePO4	794 g	199,95

Linterna de mano



Ref.	Código	lúmenes	autonomía horas	€ / u.
21056018	Q1MINI	120	1,5	38,62
21056019	Q2R	450	1,25	97,09
21056020	Q3	380	2,25	71,71
21056021	Q3R	500	2	142,31

Multilinternas



Ref.	Código	lúmenes	autonomía horas	€ / u.
2402846	M6R	600	3,75	98,19
2402847	M6XR	2000	2,25	141,21



08

Linterna frontal



S2



S4



V3AIR

Ref.	Código	lúmenes	autonomía horas	€/ u.
21056023	S2	200	4,5	54,93
21056024	S4	300	5	76,53
21056025	S4R	500	5,5	98,13
21056026	V3AIR	340	3,5	60,08
21056027	V3AIRRECAR	360	1,75	87,59

Linterna antideflagrante



Con certificados ATEX,IECEx,...



6901252158



6911252158



6911252166

Ref.	Código	Descripción	Certificación ATEX	Dimensiones mm	Peso gr Sin pilas	Peso gr Con pilas	Tipo de pila	€/ u.
1308710	6901252158	Linterna LED PX2 Aprox. 30 lúmenes (Tipo Bolígrafo)	ZONA 1	143 x 19	20	40	2 x AAA 1,5V	32,20
1308711	6911252158	Linterna LED PX1 Aprox. 120 lúmenes	ZONA 1	167 x 38	80	175	4 x AA 1,5V	58,90
1308712	6911252166	Linterna LED PX0 Aprox. 120 lúmenes	ZONA 0	167 x 38	80	175	4 x AA 1,5V	74,30

Equipo seguridad



Ref.	Código	Descripción	Lúmenes	Autonomía	Alcance	Resistencia agua	Resistencia caldas	Peso	Diámetro	Longitud	Pila incluida	€/ u.
8001410	IP2201G	MAGLITE® Equipo de seguridad LED 2AA. Linternas de 2 pilas tipo AA-LR06 y cono rojo de señalización.	97	11h / 32h	145 m	IPX4	1 m	117,75 g	25,4 mm	167,8 mm	2xLR06	59,95

Cono tráfico

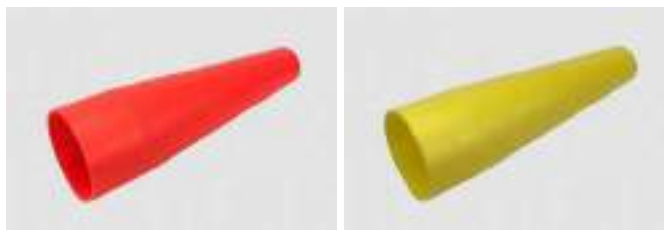

Ref.	Código	Descripción	Descripción	€ / u.
1308686	ARXX26B	Compatible con Magcharger, ML300, Standard D, Standard C	Cono tráfico rojo linternas pila tipo D y MagCharger	13,95
1308687	ARXX28B	Compatible con Magcharger, ML300, Standard D, Standard C	Cono tráfico amarillo linternas pila tipo D y MagCharger	13,95

Focos Solares



Ref.	Código	Descripción	Dimensiones foco	Protección	Batería	Tiempo de carga	Tiempo iluminación	Superficie iluminación	Longitud cable	Peso	€ / u.
20041121	620630	25 W 25 LEDS 170 Lumen/W	210 x 160 x 60 mm	IP67	3,2 V 8000 mA	4-6 horas	12 horas	60 m	4,70 m	2,2 kg	52,00
20041122	620640	60 W 25 LEDS 117 Lumen/W	260 x 200 x 70 mm	IP67	3,2 V 12000 mA	4-6 horas	12 horas	60 m	4,70 m	2,8 kg	92,00
20041124	620645	100 W 36 LEDS 117 Lumen/W	340 x 270 x 90 mm	IP67	3,2 V 16000 mA	4-6 horas	12 horas	150 m	4,70 m	5,4 kg	153,00
20041125	620650	200 W 36 LEDS 117 Lumen/W	370 x 300 x 90 mm	IP67	3,2 V 20000 mA	4-6 horas	12 horas	150 m	4,70 m	6 kg	176,00

Pila alcalina



Ref.	Código	Voltaje V	Pilas/ blister	€ / u.	Ref.	Código	Voltaje V	Pilas/ blister	€ / u.
1801700	LR03PPG/4BP	1,5	4	5,82	1801706	LR-44EL/1B	1,5	1	3,14
1801701	LR6PPG/4BP	1,5	4	5,82	1801707	CR-2032EL/1B	3	1	2,94
1801702	LR14PPG/2BP	1,5	2	6,41	1801708	LRV08L/1BP	12	1	2,46
1801703	LR20PPG/2BP	1,5	2	9,98	1801709	4R25RZ/B	6	1	14,90
1801704	6LRF22PPG/1BP	9	1	7,51	1801710	CR-2016EL/1B	3	1	2,94
1801705	3LR12PPG/1BP	4,5	1	14,50	1801711	CR-2025EL/1B	3	1	2,94



Batería KB Standard



KB1223



KB1272F1



KB1250F2

Ref.	Código	Voltaje V	Capacidad Ah	Largo Medidas mm	Ancho Medidas mm	Alto Medidas mm	Alto C/Terminal Medidas mm	Terminal	Peso kg	€/ u.
1705160	KB1208	12	0,8	96	25	62	62	T9	0,38	16,31
1705161	KB1223	12	2,2	178	35	61	67	F1	0,98	13,38
1705164	KB1272F1	12	7,2	151	64	94	101	F1 / F2	2,23	19,26
1705165	KB12120F1	12	12	151	98	95	102	F1 / F2	3,7	33,02
21117024	KB1250F2	12	5	90	70	101	107	F1	1,5	16,46
21117025	KB1270SECURITY	12	7	151	65	94	101	F1	1,8	16,03
21117026	KB1290F2	12	9	151	65	94	101	F2	2,45	23,85
21117027	KB12120F2	12	12	151	98	95	102	F2	3,5	33,02
21117028	KB12180	12	18	181	77	167	167	M5	5	47,75
21117029	KB12260	12	26	166	175	126	126	M5	7,45	73,69

Pila recargable



Pila recargable. Serie Evolta

Serie Evolta

Ref.	Código	Tipo	Vol.	M Ah	Pilas/ embalaje	€/ u.
1810000	HHR-3XXE/4BC	AA	1,2	2.450	1 / 12 / 60	52,61
1810001	HHR-4XXE/4BC	AAA	1,2	900	1 / 12 / 60	37,73

Serie "Ready to use"

Ref.	Código	Tipo	Vol.	M Ah	Pilas/ embalaje	€/ u.
1810010	HHR-3MVE/4BC	AA	1,2	1.900	1 / 12 / 60	30,29
1810011	HHR-4MVE/4BC	AAA	1,2	750	1 / 12 / 60	26,04



Serie Pro + [NI-MH]

Ref.	Código	Tipo	Vol.	M Ah	Pilas/ embalaje	€/ u.
1810020	HHR-1SRE/2B	R-20/D	1,2	2.800	1 / 12 / 60	47,83
1810021	HHR-2SRE/2B	R-14/C	1,2	2.800	1 / 12 / 60	47,83

Cargador de pilas



Cargador 8H. + 4 AA 1900Mah

Ref.	Código	Descripción	Embalaje	€/ u.
21117000	K-KJ17MGD40E	Cargador 8H. + 4 P6PE 1900Mah	12	54,90
21117001	K-KJ50LGA20E	Cargador 10H. + 2 P6PE 1000Mah	6	31,00



Batería de iluminación de emergencia Ni-Cd



Ref.	Código	Voltaje V	M Ah	Tamaño	Dimensiones mm	€/ u.
1705190	SC1600MAH24V	2,4	1.600	2 x SC	23 x 86	7,69
1705191	SC1600MAH36V	3,6	1.600	3 x SC	23 x 129	10,53
1705192	SC1600MAH48V	4,8	1.600	4 x SC	23 x 172	12,14
1705193	SC1600MAH6V	6	1.600	5 x SC	23 x 215	15,66
1705194	D4000MAH24V	2,4	4.000	2 x D	33 x 120	15,66
1705195	D4000MAH36V	3,6	4.000	3 x D	33 x 180	23,50
1705196	D4000MAH48V	4,8	4.000	4 x D	33 x 240	33,43
1705197	D4000MAH6V	6	4.000	5 x D	33 x 300	41,82
1705198	BD4000BT2S	2,4	4.000	2 x D	66 x 33 x 60	18,00
1705199	BD4000BT3S	3,6	4.000	3 x D	99 x 33 x 60	25,33
1705205	AA1000MAH12V	12	1.000	10 x AA	73 x 29 x 50	18,14



Batería KB Long Life



Ref.	Código	Voltaje V	Capacidad Ah	Largo Medidas mm	Ancho Medidas mm	Alto Medidas mm	Alto C/Terminal Medidas mm	Terminal	Peso kg	€/ u.
21117002	KBL12330	12	33	195	131	155	165	M6	9,7	103,08
21117003	KBL12400	12	40	197	165	171	171	M6	12,5	129,23
21117004	KBL12550	12	55	229	138	209	228	M6	16,2	163,08
21117005	KBL121000	12	100	330	172	214	220	M8	28,5	273,85

Batería AGM Solar



Ref.	Código	Voltaje V	Capacidad Ah	Largo Medidas mm	Ancho Medidas mm	Alto Medidas mm	Alto C/Terminal Medidas mm	Terminal	Peso kg	€/ u.
21117006	KBAS121200	12	120	330	173	212	220	M8	30	261,54
21117007	KBAS122500	12	250	522	240	218	224	M8	58	529,85

Batería Gel Solar



Ref.	Código	Voltaje V	Capacidad Ah	Largo Medidas mm	Ancho Medidas mm	Alto Medidas mm	Alto C/Terminal Medidas mm	Terminal	Peso kg	€ / u.
21117008	KBGS121200	12	120	330	173	212	220	M8	30	283,08
21117009	KBGS122500	12	250	522	240	218	224	M8	58	553,85

Contenedor de residuos de 120 litros



Eco Tayg 120 litros tapa gris



Ref.	Código	Medidas mm	€ / u.	Ref.	Código	Medidas mm	€ / u.
715640	422003	Con tapa gris	56,42	715648	423031	Con tapa verde con pedal	61,24
715641	422010	Con tapa amarilla	56,42	715649	423109	Con tapa roja con pedal	61,24
715642	422027	Con tapa azul	56,42	715652	443077	Eco Tayg negro con pedal	55,13
715643	422034	Con tapa verde	56,42	715653	443008	Eco Tayg gris con pedal	81,59
715644	422102	Con tapa roja	56,42	715654	443015	Eco Tayg amarillo con pedal	81,59
715661	442070	Eco Tayg negro	51,00	715656	443022	Eco Tayg azul con pedal	81,22
715645	423000	Con tapa gris con pedal	61,24	715650	424007	Para jardín verde	77,13
715646	423017	Con tapa amarilla con pedal	61,24	715651	426001	Para jardín verde con pedal	83,03
715647	423024	Con tapa azul con pedal	61,24				

Escoba de mijo



Ref.	Código	Descripción	€ / u.
1900100	1806	Escoba de mijo de tres cordones	10,56
1900101	1809	Escoba de mijo de cuatro cordones	11,54
1900102	1808	Escoba de mijo de cinco cordones	12,16
1900103	1807	Escoba de mijo de seis cordones	14,10



Escoba y escobón



Ref.	Código	Descripción	€/ u.
1900202	1757	Escoba moqueta sin mango	3,26
1900203	1805	Escoba industrial con mango	7,32



1757



1805

Fregona



Ref.	Código	Descripción	€/ u.
1900300	7002	Algodón crudo 170 gr.	2,16
1900301	7003	Algodón especial 190 gr.	2,35
1900302	7008	Algodón crudo 250 gr.	3,13



7002



7003



7008

Contenedor de residuos



Eco Tayg 95 litros tapa gris



410000



410017



410024



410031



410109

Ref.	Código	Medidas mm	€/ u.
715860	410000	Eco Tayg 95 l. negro / gris	28,23
715861	410017	Eco Tayg 95 l. negro / amarillo	28,23
715862	410024	Eco Tayg 95 l. negro / azul	28,23
715863	410031	Eco Tayg 95 l. negro / verde	28,23
715864	410109	Eco Tayg 95 l. negro / rojo	28,23
715865	411007	Eco Tayg 75 l. negro / gris	24,58
715866	411014	Eco Tayg 75 l. negro amarillo	24,58
715867	411021	Eco Tayg 75 l. negro / azul	24,58

Ref.	Código	Medidas mm	€/ u.
715868	411038	Eco Tayg 75 l. negro / verde	24,58
715869	411106	Eco Tayg 75 l. negro rojo	24,58
715870	412004	Eco Tayg 50 l. negro / gris	17,67
715871	412011	Eco Tayg 50 l. negro / amarillo	17,67
715872	412028	Eco Tayg 50 l. negro / azul	17,67
715873	412035	Eco Tayg 50 l. negro verde	17,67
715874	412103	Eco Tayg 50 l. negro / rojo	17,67

Toallita limpiadora profesional



Solución inmediata para la limpieza de manos, herramientas y otras superficies. Elimina aceites, grasa, pintura, tintas y pegamento. Gran absorción. No transfiere la suciedad. Ideal para limpieza sin agua. Cómodo, simple y fácil de usar.

Ref.	Código	Descripción	€/ u.
1106050	1030287	Envase 50 toallitas	14,25
1106051	1030238	Envase 100 toallitas	22,92



08

Limpiador lavamanos. FAST ORANGE 3,78L



Limpiador lavamanos natural y biodegradable. Limpieza eficaz sin agua con agradable fragancia cítrica.

Ref.	Código	Capacidad L	€ / u.
2402848	35406	3,8 L	32,52



SCRUBS



Lavamanos industrial de gran eficacia. No contiene derivados del petróleo. Aroma a cítricos.

Ref.	Código	Descripción	€ / u.
1901803	13943	Toallitas lavamanos 72 unidades	39,95



Trapo

Ref.	Código	Descripción	€ / u.
1900800	466850	Trapo blanco fardo de 5 kg	23,85
1900801	466851	Trapo blanco fardo de 25 kg	129,23
1900802	466852	Trapo de color fardo de 5 kg	18,44
1900803	466853	Trapo de color fardo de 25 kg	86,76
1900804	466954	Bobina de algodón punto azul	21,28
1900805	466955	Bobina de algodón punto blanco	21,28



Cotón



Ref.	Código	Descripción	€ / u.
1900900	466854	Cotón blanco fardo de 5 kg	28,36
1900901	466855	Cotón blanco fardo de 25 kg	141,85
1900902	466856	Cotón de color fardo de 5 kg	18,28
1900903	466857	Cotón de color fardo de 25 kg	91,41



Crema Lavamanos con abrasivos naturales. Manos Muy Sucias



CITRO CREM + Dosificador. Crema Lavamanos con microesferas. Lavamanos para atodo tipo de suciedades y grasas profundas en industrias y talleres

Ref.	Código	Capacidad KG	€ / u.
2402849	2122/5	5	24,10



Pasta Lavamanos. Pasta Sólida para manos



PAST MAN 1 GT. Pasta desengrasante para manos. Producto desengrasante en forma de pasta, adecuado para la limpieza de manos muy grasientas. Remueve aceites, valvulinas, molikotes, grafitos, etc. Deja la piel suave y aroma agradable. Por su composición, no se licua en temperaturas extremas.

Ref.	Código	Capacidad KG	€ / u.
2402850	1676/10	10	82,45
2402851	1676/25	25	206,25



Pasta Lavamanos Industrial



Pasta Lavamanos Industrial. Elimina sin esfuerzo grasas, aceites y suciedades extremas. Contiene agentes de fricción que facilitan el desengrase.

Ref.	Código	Capacidad L	€ / u.
2402852	2718/5	5	29,75



Gel Cítrico para Lavado de manos



CITRO GEL + Dosificador. Gel Desengrasante para limpieza de todo tipo de suciedad de las manos. No contiene disolventes que perjudiquen la piel.

Ref.	Código	Capacidad L	€ / u.
2402853	1940/5	5	23,70



Pasta para limpieza de manos



CITRO PAST + Dosificador. Pasta Desengrasante de manos, para la limpieza de manos muy grasientas. Con abrasivos naturales

Ref.	Código	Capacidad KG	€ / u.
2402854	2676/10	10	82,80



Pasta lavamanos



Desengrasante en forma de pasta, para la limpieza de manos muy grasientas. Debido a su composición, con grano tierra permite eliminar las suciedades más incrustadas en la piel, dejando las manos limpias y suaves. Utilizar con manos secas.

Ref.	Código	Capacidad KG	€ / u.
8004819	2718/5	5	29,75



08

Crema lavamanos



Desengrasa y disuelve todo tipo de suciedad: grasa, carbón, mugre etc). No deja residuos dejando la piel suave y limpia. Posee microesferas en suspensión que, al frotar, aumentan el poder de desengrase, dejando las manos completamente limpias



Ref.	Código	Capacidad KG	€ / u.
8004818	2122/5	5	24,00

Lavamanos olor cítrico. CITRUS HANDCLEANER



Limpiador de manos profesional, sin disolventes, con Aloe Vera, Jojoba y abrasivos respetuosos con el medio ambiente. Suave para la piel. Fragancia fresca. Elimina fácilmente: lubricantes, grasa, alquitrán y líquidos de frenos. Envase con dispensador. Fácilmente diluible en agua. Sin alcohol.



Ref.	Código	Capacidad ml	€ / u.
21030018	1031393	3.8 L	36,51

Rollo K azul de 2 capas



Rollo de papel para limpieza industria. Resistente al desgarramiento. Sin capas encoladas. Capacidad absorbente. Peso: 20 g/m² . 1000 servicios. Perforado. Para limpiezas sencillas en talleres de coches.



Ref.	Código	Hoja única cm	€ / u.
715695	4270604050	38 x 36	65,00

Soporte de pie para bobinas

Con dispositivo de fijación con bolsas para basura. Para bobinas de hasta 40 cm de anchura. Entrega: Sin bobinas secamanos.



Ref.	Código	Medidas mm	€ / u.
715697	4270604150	90 x 40 x 44	23,30

Bobina de celulosa

Ref.	Código	Descripción	€ / u.
1901000	666850	Bobina de pasta de celulosa	22,36
1901001	666851	Bobina de celulosa reciclada	19,26
1901002	666852	Rollo de papel higiénico doble capa	5,53
1901003	RSA63	Soporte de bobina de celulosa mural	50,20
1901004	RSA62	Soporte de bobina de celulosa de pie	50,20



RSA62



RSA63





982
Fijación y sellado



1002
Sellador de silicona

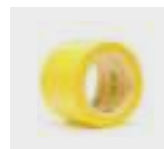

1032
Cintas de vinilo



984
Unión instantánea

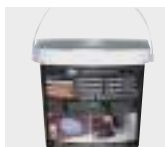

1008
Silicona líquida

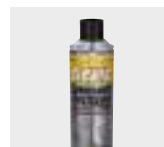

1034
Lubricantes

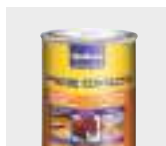

985
Adhesivos de contacto



1012
Adhesivos de montaje



1037
Limpia contactos



988
Antiproyecciones



1014
Espumas poliuretano

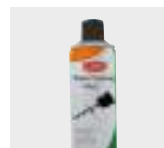

1041
Aceites de corte



990
Pinturas



1016
Pistolas



1043
Lubricantes industria alimentaria

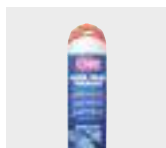

993
Pintura de obra



1019
Anclajes químicos



1043
Grasas



993
Marcadores



1021
Cintas



1045
Grasas en spray



994
Tizas



1021
Cinta americana



1047
Bombas de engrase



995
Recubrimientos



1023
Cinta aislante



1048
Boquillas de engrase



997
Limpiadores



1024
Cintas eléctricas



1052
Aceiteras



999
Desengrasantes

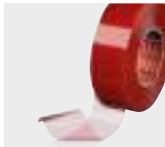

1029
Cintas doble cara



1053
Bombas de pedal



1054
Equipos neumáticos
de engrase



1055
Dispensadores
de aceite



1056
Bombas
equipadas

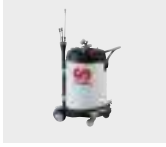

1057
Aspirador de
aceite



1057
Bombas
de agua

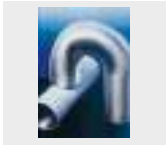

1059
Mangueras

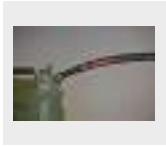

1069
Mangueras
de caucho

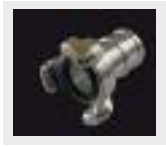

1073
Racores

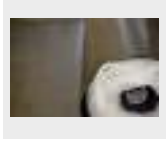

1079
Planchas
de goma

09

PRODUCTOS QUÍMICOS

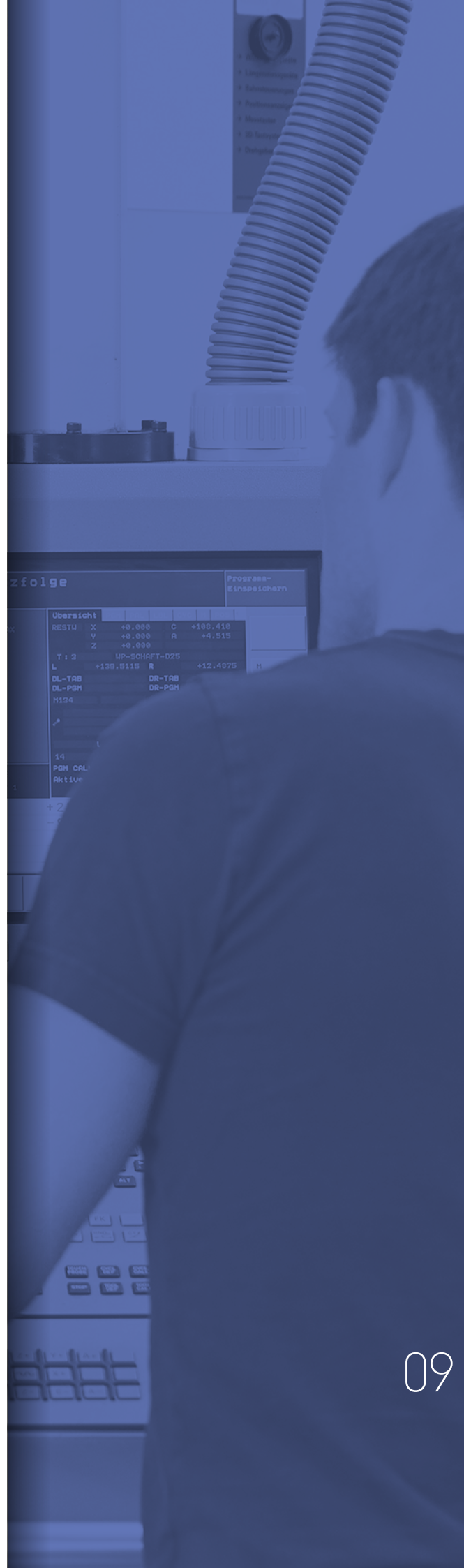

Fijación de roscas



Resistencia a las vibraciones, monocomponente: limpio y fácil de aplicar. Puede utilizarse en tornillos de todas las medidas. Permite sellar taladros pasantes roscados.

Ref.	Código	Descripción	Capacidad ml	€ / u.
1100100	1335838	243-Resistencia media	10	14,09
1100000	88245	222-Resistencia baja	50	52,36
1100001	231510	222-Resistencia baja	250	213,32
1100101	1335881	243-Resistencia media	50	54,91
1100102	1335924	243-Resistencia media	250	211,26
1100300	1335887	270-Resistencia alta	50	53,30
1100301	1335909	270-Resistencia alta	250	204,23



1335838



1335887

Sellado de roscas EASY SEAL



Sellador de roscas blanco desarrollado para sellar uniones roscadas a presiones moderadas. Permite el reposicionamiento en las conexiones tratadas. Fácil de desmontar con herramientas normales incluso después de algunos años. CRC Easy Seal contiene PTFE para ajustar las uniones uniformemente, incluso en caso de roscados toscos. Alta resistencia a: temperatura, corrosión, vibraciones, agua, gas, aceites, hidrocarburos y la mayoría de los componentes químicos

Ref.	Código	€ / u.
21030013	1030740	18,63



Sellado de roscas



Sustituyen al cáñamo, a las cintas y a la pasta. Sellan al 100%. No se deforman ni contraen, y no desprenden fibras. Fácil desmontaje con herramientas normales.

Ref.	Código	Descripción	Capacidad ml	€ / u.
1100500	2068162	577-Roscas de uso general	50 (fuelle)	31,37
1100400	88547	542-Roscas neumáticas-hidráulicas	50	36,16
1100401	234408	542-Roscas neumáticas-hidráulicas	250	139,16
1100501	2068151	577-Roscas de uso general	50	30,42
1100502	2068161	577-Roscas de uso general	250	124,49



88547

Sellador universal para todo tipo de roscas



Sellador universal para todo tipo de roscas. Uni-Lock es un sellador universal apropiado para conseguir la estanqueidad de uniones de tuberías roscadas plásticas y/o metálicas. Sustituye de forma práctica las cintas de teflón o cáñamo, asegurando la estanqueidad entre las roscas.

Ref.	Código	Capacidad m	€ / u.
21048022	2055959	160	23,15



Junta sellado de bridas



Sin necesidad de cuñas de reglaje. Rellenan todas las cavidades. Las piezas pueden desmontarse fácilmente incluso después de un largo tiempo de servicio. Una vez curan por completo, resisten altas presiones.

Ref.	Código	Descripción	Capacidad ml	€ / u.
1101000	88115	574-Formador de juntas rígidas	50 (fuelle)	34,33
1100800	234219	510-Formador de juntas rígidas alta temperatura	50	35,65
1100801	234238	510-Formador de juntas rígidas alta temperatura	250	134,54
1101001	88560	574-Formador de juntas rígidas	50	34,33
1101002	88561	574-Formador de juntas rígidas	250	132,04



88560



234219



Junta sellado de bridas. FLEX SEAL PRO



Formador de juntas de silicona RTV. Color negro. Altamente viscoso y tixotrópico. Excelente adhesión. Buena resistencia a la temperatura hasta +250°C. Muy buena elasticidad para todas las juntas flexibles. Se puede aplicar en vertical o boca-abajo. Resistente a vibraciones y a expansión térmica. Cómodo y fácil de usar gracias a su aplicador



Ref.	Código	Capacidad ml	€ / u.
21030015	1754358	200	17,82

Retención



Productos de alta resistencia: pueden soportar grandes cargas. Rellenan todas las cavidades: previenen la corrosión. Reducen la necesidad de ajustar tolerancias. 100% de contacto: la carga y la tensión se distribuyen uniformemente.

Ref.	Código	Descripción	Capacidad ml	€ / u.
1101200	1967547	603- Retenedor montajes ajustados	10	13,91
1101201	229871	603- Retenedor montajes ajustados	50	57,58
1101202	229965	603- Retenedor montajes ajustados	250	217,41
1101300	1767161	638-Retenedor montajes holgados	50	56,45
1101301	1767237	638-Retenedor montajes holgados	250	224,03
1101400	88580	641-Retenedor montajes fácil desmontaje	50	55,90
1101401	234868	641-Retenedor montajes fácil desmontaje	250	213,49
1101500	1804411	648-Retenedor alta temperatura	50	59,27
1101501	1804972	648-Retenedor alta temperatura	250	235,14



1967547

1804411

Retención. EXTRA LOCK



Fijador para roscas y retenedor de rodamientos, desarrollado para soportar fuertes presiones para la unión permanente de uniones roscadas y para la fijación de rodamientos. Difícil o no es posible el desmontaje con herramientas normales. Su tixotropía y moderada viscosidad proporcionan al adhesivo una buena capacidad de relleno. Alta resistencia a: temperatura, corrosión, vibraciones, agua, gas, aceites, hidrocarburos y la mayoría de productos químicos.

Ref.	Código	Capacidad ml	€ / u.
21030014	1030738	50	18,63



Adhesivo para uniones de PVC



Adhesivo Especial para conducciones de presión en PVC rígido. Apto para todas las presiones. Funciona como soldadura química. Respeta normas internacionales.



402984

415903

34949

298585

420286

Ref.	Código	Descripción	€ / u.
1102984	402984	Tangit Adhesivos PVC tubo 125 gr.	8,24
1125903	415903	Tangit Adhesivos PVC lata 500 gr.	25,31
1134949	34949	Tangit Adhesivos PVC lata 250 gr pincel	16,04

Ref.	Código	Descripción	€ / u.
1198585	298585	Tangit Adhesivos PVC lata 500 gr pincel	26,18
1120286	420286	Tangit Adhesivos PVC lata 1 kg pincel	44,34

Unión instantánea



Producto de uso general para unir la mayoría de los materiales, como plásticos, caucho, metales, cartón y madera.

Ref.	Código	Descripción	Capacidad ml	€ / u.
1101701	406631	401-Adhesivo uso general	3	5,30
1101703	404911	401-Adhesivo uso general	20	22,74
1101704	233656	401-Adhesivo uso general	50	47,36
1101705	233669	401-Adhesivo uso general	500	337,57
1101800	1922290	406-Adhesivo elastómeros	20	28,18
1101801	233697	406-Adhesivo elastómeros	50	59,62
1101802	88500	406-Adhesivo elastómeros	100	105,88
1101803	233707	406-Adhesivo elastómeros	500	388,19
1101900	407869	454-Adhesivo en gel uso general	3	6,71
1101901	88524	454-Adhesivo en gel uso general	20	28,94
1101902	88526	454-Adhesivo en gel uso general	300	349,20



1922290



407869

Unión instantánea. QUICK FIX



Adhesivo transparente de cianocrilato para una unión FUERTE y RÁPIDA de piezas no estructurales. Une plástico y metal. Permite un tiempo amplio de posicionamiento de las piezas a unir.

Ref.	Código	Capacidad gr.		€ / u.
21030017	1030748	20	PCA18 QuickFix.jpg	7,62



1030750



1030748

Adhesivo universal instantáneo



Máxima fuerza de unión.



2640067



2642430



2640968



2646770



2640066

Ref.	Código	Descripción	Características	€ / u.
1589331	2640067	Loctite Super Glue-3 Power Flex 3 gr.	Flexible.	8,07
1591698	2642430	Loctite Super Plastics 4 ml / 2 gr.	Pega todo tipo de plásticos	10,76
1579622	2640968	Loctite Super Glue-3 Original 3 gr.	Tapón antiobstrucción. Nueva fórmula resistente al agua.	6,79
1589255	2640065	Loctite Super Glue-3 Mini Trio	Tapón antiobstrucción. Nueva fórmula resistente al agua.	8,76
1680621	2640969	Loctite Super Glue-3 Pincel 5 gr.	Limpio y seguro.	11,70
1579617	2640076	Loctite Super Glue-3 Precisión 5 gr.	Máxima precisión.	10,01
1588407	2640970	Loctite Super Glue-3 Precisión Max 10 gr.	Precisión absoluta.	13,31
21048000	2646770	Loctite Super Glue-3 Profesional 20 gr.	Para uso intensivo	13,78
21048001	2640066	Loctite Super Glue-3 Cristal	Resistente al agua	9,83

Unión estructural



Epoxi bicomponente multiuso, rápido, ultratransparente.

Ref.	Código	Descripción	Capacidad ml	€ / u.
1102200	266585	3430-Adhesivo epoxi plástico	24	19,01
1102201	2035021	3430-Adhesivo epoxi plástico	50	32,14
1102250	1886335	3450-Adhesivo epoxi metal	25	17,16

266585



1886335



Soldadura y masilla reparadora



Sustituto universal de juntas



Ref.	Código	Descripción	€/ u.
2402855	2881573	Pattex Nural 46 blister 11 ml.	11,15
1548574	1768322	Pattex Nural 27 blister 22 ml.	13,99
1548576	1768323	Pattex Nural 27 blister 120 ml.	47,97
1770933	1770933	Pattex Nural 34 blister 50 gr.	11,40
1327821	1843791	Pattex Nural 43 barra 48 gr.	15,31
21048002	2461848	Pattex Nural 21 blister 22 ml.	13,10
21048003	2461849	Pattex Nural 21 blister 120 ml.	33,33
21048004	2461850	PattexX Nural-21 1 KG	130,78
21048005	1755651	Pattex Nural 28 estuche 75ml.	21,96

Ref.	Código	Descripción	€/ u.
21048006	1755255	Pattex Nural 28 Blister 40ml.	14,06
21048007	1766709	Pattex Nural 28 estuche 40ml.	14,06
21048008	1769654	Pattex Nural 25 Blister 22ml.	13,10
21048009	1753668	Pattex Nural 23 Blister 22ml.	13,49
21048010	1758642	Pattex Nural 50 Blister 10ml.	13,13
21048011	1771549	Pattex Nural 70 Lata 30-50L.	47,83
21048012	1768130	Pattex Nural 10 Tubo 110gr.	18,63
21048013	2550380	Pattex Nural 30 Blister 140gr.	11,64

Adhesivo en aerosol



Adhesivo en aerosol no clorado de rápida fijación.

Ref.	Código	Descripción	Capacidad ml	Características	€/ u.
1130383	1030591	Fast Stick	500	Extra rápido. Reposicionable	21,62
1130454	1030629	Power Stick	500	Adhesivo extra fuerte	21,62



Adhesivo en aerosol. SUPERGEN 62610



Ideal para superficies grandes, sobre todo irregulares y que sea difícil aplicar con pincel.

Ref.	Código	Capacidad ml	€/ u.
1108950	62610-00000-00	500	22,42



Adhesivo de contacto. BUNITEX P-55



Adhesivo de contacto. Uniones flexibles, resistentes y duraderas. Fuerte agarre inicial y con tiempo de trabajo largo. Pegado de caucho, goma, cuero, madera, corcho, formica, metal, plásticos, fibras vegetales o sintéticas, cerámica, cartón, tejidos, etc.

Ref.	Código	Descripción	€/ u.
1100180	10043191	Bote 250 ml	3,63
1100181	10043189	Bote 500 ml	6,47
1100182	10043190	Bote 1000 ml	9,85
1100183	10043192	Bidon 5 L	45,85



Adhesivo de contacto. SUPERGEN 62600



Adhesiones flexibles, resistentes y duraderas. Resistente a la humedad, soporta bien ácido y base diluïdos. Pegado de maderas, diversidad de plástico duros , corcho, metal, caucho, cuero, cerámicas, cartón, tejidos, etc.

Ref.	Código	Descripción	€ / u.
1108899	62600-00000-04	Tubo de 40 ml.	2,61
1108900	62600-00000-05	Tubo de 75 ml.	3,52
1108902	62600-00000-08	Bote de 500 ml.	7,80
1108903	62600-00000-09	Bote de 1 L.	13,35
1108904	62600-00000-10	Lata de 5 L.	57,86



Cola termofusible

Barras de adhesivo termofusibles que se pueden emplear con todas las pistolas más usuales.

Ref.	Código	Color	Descripción mm	€ / u.
1109100	11200	Negro	11 x 200	12,66
1109101	11201	Gris	11 x 200	12,66
1109102	11202	Amarillo	11 x 200	12,66
1109103	11203	Transparente	11 x 200	12,66



Cola Contacto A-30 Adhesivo Universal Super Fuerte



Adhesiones flexibles, resistentes y duraderas. Resistente a la humedad, soporta bien ácido y base diluïdos. Pegado de maderas, diversidad de plástico duros , corcho, metal, caucho, cuero, cerámicas, cartón, tejidos, etc.

Ref.	Código	Descripción	€ / u.
2402856	H40432	Bote 250 ml	6,24
2402857	H40219	Bote 500 ml	9,34
2402858	H40218	Bote 1000 ml	13,94
2402859	H40220	Bidon 5 L	58,29
2402860	H40217	Bidon 25 L	254,01



Cola Blanca D2 A-22



Cola blanca para de contacto para uniones resistentes, a base de acetato de polivinilo. Para todo tipo de maderas.

Ref.	Código	Descripción	Capacidad Kgr	€ / u.
2402861	H40212	6 kg	6	51,15
2402862	H40213	12 kg	12	71,55
2402863	H40211	30 kg	30	193,55



Cola Blanca D3 A-23



Cola blanca de secado rápido, de alta calidad y potente poder de adhesión, a base de acetato de polivinilo

Ref.	Código	Capacidad gr	€ / u.
2402864	H40214	250	5,59
2402865	H40215	500	7,75
2402866	H40216	750	7,75



Banda Cola PU 458



Banda de solape para pegado de rollos de césped artificial Tejido a base de poliéster con capa de apoyo impermeabilizada



Ref.	Código	Descripción	Dimensiones	€ / u.
2402867	20648	Banda de solape de césped	30 cm x 100 m	115,27

Cola PU 458



Cola de poliuretano de 2 componentes de rápido curado y altas resistencias mecánicas. Supera los ensayos exigidos por la FIFA



Ref.	Código	Descripción	Capacidad kg	€ / u.
2402868	20786	Cola para césped	12 kg	72,55

Cola blanca para madera UNIFIX rápida



Cola Blanca para madera. Pegado rápido. Transparente una vez seca. Indicada para el encolado de todo tipo de muebles de madera y pegado de aglomerados, laminados, cartón, papel y piezas de modelismo.



Ref.	Código	Capacidad gr	€ / u.
1100185	10043825	135	2,61
1100186	10043877	250	4,57
1100187	10043869	500	6,52

Cola blanca. SUPERGEN 62605



Para unión de superficies de madera, papel...

Ref.	Código	Capacidad gr	€ / u.
1109050	62605-00000-00	125	3,10
1109051	62605-00000-01	250	4,71
1109052	62605-00000-02	500	6,94
1109053	62605-00000-03	750	7,67



Detector de grietas



Inspección de materiales, piezas, ensamblajes, equipos, superficies o estructuras. Fisuras y cavidades en zonas soldadas. Fisuras en hierro fundido.

Ref.	Código	Denominación	Características	Capacidad ml	€ / u.
1106100	1030758	CRICK 110	Limpiador	500	13,28
1106101	1030475	CRICK 120	Penetrante	500	17,92
1106102	1030412	CRICK 130	Revelador	500	13,86



1030758

1030475

1030412

09

Antiproyecciones de soldadura. ANTISPATTER



Previene y elimina las proyecciones de soldadura. Previene la obstrucción de la boquilla. No contiene silicona. Base Disolvente. No inflamable.



Ref.	Código	Capacidad ml	€ / u.
1105903	1031384	500	7,28

Antiproyecciones de soldadura



Ref.	Código	Capacidad ml	€ / u.
1137233	37233	400	6,65

Antiadherente para proyecciones de soldadura sin silicona. WELDING SPRAY



Formulado especial exento totalmente de silicona, evita las proyecciones de soldadura de hilo continuo y la obturación de las boquillas, permitiendo posteriores operaciones de pintado. Envasado sin gas butano.



Ref.	Código	Capacidad ml	€ / u.
1116300	1790	400	4,60

Antiproyecciones de soldadura base agua. ECO BIO WELD



Ecológico. Previene y elimina las proyecciones de soldadura. Previene la obstrucción de la boquilla. No contiene silicona. Base agua. No inflamable. No nocivo.



Ref.	Código	Capacidad	€ / u.
1100190	1031171	500 ml	6,87
1100191	1030159	5 L	38,33
1100192	1030718	20 L	135,45

Detector de fugas de gases. ECO LEAK FINDER FPS



Detecta y localiza rápidamente y de forma fiable, las fugas de gas y las pérdidas de presión en tuberías, sistemas de presión, etc. formando burbujas fácilmente visibles. Base agua. NO INFLAMABLE. Puede emplearse para gas natural, propano, butano, acetileno, LPG, nitrógeno, dióxido de carbono, aire comprimido, refrigerantes, oxígeno y otros tipos de gases. Compatible con metales y plásticos. Biodegradabilidad de acuerdo a la OECD 301B: 31%. No corrosivo. Seguro en todas las superficies metálicas, sin coloración. Válvula de 360° (todas posiciones). Certificado NSF P-1 para usar en industria alimentaria



Ref.	Código	Capacidad ml	€ / u.
1100195	1752465	500	12,09

Detector de fugas



Detector de fugas de conductos de fluidos.

Ref.	Código	Descripción	Capacidad ml	€ / u.
1536853	36853	Detector de fugas STEC	400	10,86



Antiproyecciones de soldadura cerámico. TORCH CERAMIC ANTI SPATTER



Aerosol cerámico antisalpicaduras de alto rendimiento que proporciona una protección duradera contra la acumulación de salpicaduras en el soplete y en su equipo de soldadura. El recubrimiento cerámico protege las boquillas de gas, las puntas de contacto y los portapuntas de contacto durante la soldadura MIG/MAG, incluso a mayores amperajes y temperaturas. CRC Torch Ceramic Anti Spatter garantiza la máxima protección y elimina la acumulación excesiva de salpicaduras en sus consumibles. CRC Torch Ceramic Anti Spatter es un recubrimiento de nitruro de boro con propiedades adhesivas de alta temperatura. • Deja un recubrimiento protector de cerámica seco, blanco y fino • Protección de larga duración del soplete (± 8 horas) • Resistente a la temperatura, hasta 900 °C en aire y hasta 2000 °C en condiciones inertes • Sin silicona • Secado rápido (+/- 15 s) • Excelente adherencia de la superficie • Sin componentes halogenados



Ref.	Código	Capacidad ml	€ / u.
21030000	1032636	250	7,78

Desmoldeante



Desmoldeante para plástico.

Ref.	Código	Descripción	Capacidad ml	€ / u.
1136853	37263	Desmoldeante E-20 (sin silicona)	500	7,84
1138253	37253	Desmoldeante S-10	500	7,16



Desmoldeante con silicona. SR MULTI



Desmoldeante de uso general para todo tipo de termoplásticos. Mejora el acabado superficial, minimiza las imperfecciones y mejora incluso las propiedades de moldeo de las herramientas bien pulida

Ref.	Código	Capacidad ml	€ / u.
8000396	1031986	500	5,50



Desmoldeante sin silicona. NSR WET.



Desmoldeante para inyección de plásticos. Película húmeda. Hasta 150°C. No interfiere en operaciones después del moldeo como pintado, imprimado, pegado o cubrición.



Ref.	Código	Capacidad ml	€ / u.
8000397	1032002	500	8,68

Eliminador de etiquetas - LABEL OFF SUPER



Eliminador de etiquetas. Elimina las etiquetas de papel adhesivas de la mayoría de superficies en 2-3 minutos después de empapar (probar en plásticos antes de usar). Registro NSF - K3



Ref.	Código	Capacidad ml	€ / u.
21030028	1031628	250	14,80
21030029	1031377	400	18,20

Pintura acrílica de secado rápido. ACRYLIC PAINT



La pintura CRC Acrylic Paint es una pintura de alta calidad que protege su superficie a la vez que le da un color intenso y duradero. Gracias a su combinación única de flexibilidad y dureza, CRC Acrylic Paint es muy resistente a los agentes externos, lo que la convierte en una pintura de protección excelente para una amplia variedad de superficies duras en todos los sectores de la industria. Se puede utilizar sobre metal, plásticos duros que se puedan pintar, madera, hormigón, papel, vidrio... • Secado rápido: seco al polvo después de +/- 15 minutos • Muy buena cubrición • Dirección del aerosol ajustable gracias a la boquilla flexible • Resistente a la intemperie y a los rayos UV • A prueba de golpes y arañazos • Para uso en interiores y exteriores



Ref.	Código	Color	RAL	€ / u.
1110700	1030881	Amarillo	1003	6,71
1110701	1030226	Naranja	2000	6,71
1110702	1030841	Rojo naranja	2002	6,71
1110703	1030203	Rojo	3000	6,71
1110704	1030835	Azul	5010	6,71
1110705	1030652	Verde	6011	6,71
1110706	1030211	Gris	7001	6,71
1110707	1030845	Marrón	8011	6,71
1110708	1030813	Negro	9005	6,71
1110709	1030818	Blanco	9010	6,71

Pintura base agua. AQUA RAL



Sin olor. No ataca materiales delicados. Alta cubrición. Capacidad: 400 ml. NOVEDOSO, fórmula ecológica BASE AGUA. Con resina de poliuretano. No ataca plásticos sensibles. Mayor resistencia química y mecánica. Tiene un contenido de COV 25% inferior. No irritante.



Ref.	Código	Color	RAL	€ / u.
1100200	1031342	Amarillo señal	1003	7,39
1100202	1031345	Amarillo cadmio	1021	7,39
1100203	1031347	Naranja amarillo	2000	7,39
1100204	1031348	Rojo fuego	3000	7,39
1100206	1030909	Rojo trafico	3020	7,39
1100207	1031350	Azul ultramar	5002	7,39
1100208	1031352	Azul genciana	5010	7,39
1100212	1030843	Verde abeto	6009	6,71
1100213	1030911	Verde	6018	7,39

Ref.	Código	Color	RAL	€ / u.
1100214	1031354	Gris plata	7001	7,39
1100215	1031355	Gris antracita	7016	7,39
1100217	1031356	Marrón avellana	8011	7,39
1100218	1031357	Negro brillante	9005	7,39
1100219	1031364	Negro mate	9005	7,39
1100221	1031362	Blanco brillante	9010	7,39
1100222	1031359	Blanco mate	9010	7,39
1100223	1031361	Blanco	9016	7,39
1100224	1031365	Barniz transparente brillo	-	7,39

Aerosol Scotch® para mantenimiento eléctrico



Ref.	Código	Descripción	Capacidad ml	€ / u.
8003099	7000032613	Anti-corrosión	400	19,03
8003100	7000032614	Pintura de aislamiento	400	21,65
8003101	7000063481	Barniz para aislamiento	400	22,12
8003102	7100046721	Deshumificador	400	14,75
8003103	7000032615	Lubricante de silicona	400	17,35
8003104	7100047868	Galvanizador de zinc	400	22,69
8003105	7000032616	Desengrasante limpiador	400	15,29
8003106	7100047862	Antioxidante	400	16,03



Pintura alta temperatura



Esmalte especial silicónico resistente a temperaturas de hasta 600° C. Ideal para tubos de escape, colectores, radiadores, termosifones, chimeneas, estufas, etc.

Ref.	Código	Color	Capacidad ml	€ / u.
21135020	7VV400	Negro	400	5,85
21135021	7VV400	Aluminio	400	5,85



Pintura fluorescente



Es un acrílico. Se aconseja utilizarlo sobre un fondo blanco. Adecuado tanto para interiores como exteriores. Para superficies metálicas, plásticas, de madera, cristal, cerámica, enyesados...



Ref.	Código	Color	Capacidad ml	€ / u.
21135030	7VP400	Amarillo	400	5,85

Pintura acrílica. ACRYLICOLOR



La gama ACRYLICOLOR es un esmalte acrílico de USO PROFESIONAL, tanto para superficies de interior como de exterior. Gran cobertura. Se adhiere sobre cualquier superficie, metal, aluminio (ideal para marcos), hierro, latón, madera, casi todos los plásticos, paredes, vidrio, cerámica, etc



Ref.	Código	Color	RAL	Capacidad ml	€ / u.
21135000	5VC400	Negro opaco	9005	400	4,40
21135001	5VB400	Negro brillante	9005	400	4,40
21135002	5VE400	Blanco brillante	9010	400	4,40
21135003	5VF400	Blanco opaco	9010	400	4,40
21135004	5VN400	Negro satinado	9005	400	4,40
21135005	5VM400	Blanco satinado	9010	400	4,40
21135006	4VK400	Rojo tráfico	3020	400	4,40
21135007	5VG400	Blanco electrodomésticos	9010	400	4,40
21135008	4VR400	Verde musgo	6005	400	4,40
21135009	5VD400	Aluminio	9006	400	4,40

Ref.	Código	Color	RAL	Capacidad ml	€ / u.
21135010	4VV400	Gris plata	7001	400	4,40
21135011	4VQ400	Verde primavera	6002	400	4,40
21135012	4VE400	Amarillo tráfico	1023	400	4,40
21135013	4VG400	Rojo vivo	3000	400	4,40
21135014	5VP400	Verde abeto	6009	400	4,40
21135015	4VP400	Azul tráfico	5017	400	4,40
21135016	4VF400	Naranja puro	2004	400	4,40
21135017	4VL400	Azul genciana	5010	400	4,40
21135018	4VY400	Pardo nuez	8011	400	4,40
21135019	4VO400	Azul celeste	5015	400	4,40

Pintura de marcaje ecológico base agua. AQUA PAINT MARKER



Válvula Boca Abajo. No descuelga. No irritante. Pintura especial para marcaje y señalización manual. Secado rápido. Tapón aplicador especial cómodo de utilizar con tapón protector. Acabado fluorescente. Resistente a bajas temperaturas (-35 °C). Amplia gama. Bajo olor. Capacidad: 500 ml.

Ref.	Código	Color	€ / u.
1130010	1030420	Fluo amarillo	8,05
1130013	1030423	Fluo azul	8,05
1130014	1030425	Blanco	8,05
1130011	1030421	Fluo naranja	8,05
1130009	1030418	Fluo rojo	8,05
1130012	1030422	Fluo verde	8,05
1130015	1031466	Fucsia	8,05
1130016	1031465	Negro	8,05



Pintura hierro micaceo



Ideal para superficies ferrosas, ya sean nuevas o parcialmente dañadas por los agentes atmosféricos. Contiene un inhibidor especial de corrosión, que permite obtener una óptima protección duradera en el tiempo y con un aspecto final NO brillante y típico de hierro antiguo. Ideal para verjas, vallas, tuberías ferrosas, pluviales, puertas, etc.



Ref.	Código	Color	Capacidad ml	€ / u.
21135024	7VB400	Hierro micaceo gris forja	400	5,85
21135025	7VC400	Hierro micaceo grafito antiguo	400	5,85



Pintura metalizada



Esmalte tanto para interiores como exteriores. Decoración en general/hobbies.

Ref.	Código	Color	Capacidad ml	€ / u.
21135026	7VJ400	Gris	400	5,85



Pintura marcador de obra



Pintura temporal para marcación de obra. Aplicación multiposición. Alta visibilidad y durabilidad.

Ref.	Código	Capacidad ml	Color	€ / u.
1163305	63305	500	Rojo	8,02
1163315	63315	500	Amarillo	8,02
1163325	63325	500	Verde	8,02
1163335	63335	500	Naranja	8,02
1163345	63345	500	Azul	8,02
1163355	63365	500	Fucsia	8,02



Pintura reflectante



Es un esmalte brillante que da un efecto cromado a los objetos sobre los cuales se aplica. Se adhiere sobre cualquier superficie: metal, aluminio, madera, cristales, casi todos los plásticos, cerámicas, etc.. Trabajos en general, decoración, hobbies, etc.

Ref.	Código	Color	Capacidad ml	€ / u.
21135033	7VH400	Dorado	400	5,85
21135034	7VI400	Cromado	400	5,85



Marcador permanente con bola de acero. FIXOLID

Marcador indeleble sobre acero, hierro, aleaciones diversas, etc. Marca sobre superficies mojadas, rugosas, grasientas ó húmedas. Diámetro de la punta 3 mm.

Ref.	Código	Color	€ / u.
1111300	11300101	Blanco	4,10
1111301	11300201	Amarillo	4,10
1111302	11300301	Rojo	4,10
1111303	11300601	Negro	4,10
1111304	11300401	Verde	4,10
1111305	11300501	Azul	4,10



Marcador de precisión con bola de acero. MARKERBALL



Pintura indeleble. Para uso industrial. Con bola de acero. Para todo tipo de superficies. Funciona en superficies húmedas, aceitosas, grasas y oxidadas. Resistente a los rayos UVA. Excelente resistencia al agua. Resistencia a temperatura: 200° C. Capacidad: 50 ml.

Ref.	Código	Color	€ / u.
1130160	1030455	Amarillo	4,56
1130163	1030461	Azul	4,56
1130158	1030451	Blanco	4,56
1130164	1030453	Negro	4,56
1130161	1030457	Rojo	4,56
1130165	1030459	Verde	4,56



Marcador permanente. MARKERPEN



Excelente cubrición gracias al uso de tecnología de corrección de fluido. Puede usarse en madera, metal, goma, vidrio, textil, papel, esmalte, plástico, cartón, azulejos, ... Aplicación limpia y fácil. No contiene Tolueno. Resistencia a Temperatura: 200°C.

Ref.	Código	Color	€ / u.
8000398	1030337	Amarillo	5,02
8000399	1030313	Azul	5,02
8000400	1030331	Blanco	5,02
8000401	1030321	Naranja	5,02
8000402	1030308	Negro	5,02
8000403	1030325	Rojo	5,02
8000404	1030317	Verde	5,02



Rotulador industrial de bombeo de pintura líquida



Secado rápido - Indeleble. NO NOCIVO Marcado indeleble en superficies limpias y lisas. Resistente a los rayos U.V. y a la intemperie. Válvula de dosificación para evitar que la pintura se seque. Sin disolventes nocivos ni metales pesados. Punta de fieltro. Rango de utilización de -20°C a 50 °C. Pintura resistente hasta los 100°C.

Ref.	Código	Color	€ / u.
1145576	45576	Negro	6,41
1145578	45578	Rojo	6,41
1145580	45580	Blanco	6,41
1145582	45582	Amarillo	6,41
1145584	45584	Azul	6,41
1145588	45588	Verde	6,41



Tiza de cera hexagonal



Para marcar cualquier superficie Para marcar en: hierro, hormigón, piedra, vidrio, madera, goma, cartón, tejidos, etc. No utilizar en superficies calientes. Resistencia máxima: 50 °C aprox. Paquete de 12 tizas.

Ref.	Código	Color	€ / u.
1145022	45022 D	Rojo	13,41
1145023	45023 D	Azul	13,41
1145024	45024 D	Amarillo	13,41
1145025	45025 D	Blanco	13,41
1145026	45026 D	Negro	13,41
1145027	45027 D	Verde	13,41



Tiza dura especial para metal «STEATITE»



Sectores de uso: soldadura, cerrajería, calderería, etc. Ideal para el marcaje en superficies rugosas. Resistencia máxima: 1.000° aprox. Para marcar, tanto en superficies frías, como al rojo vivo.

Ref.	Código	Dimensiones mm	€ / u.
1145028	45028	100 x 10 x 5	20,17
1145029	45029	100 x 10 x 10	23,06
1145030	45030 D	100 x 10 x 10	7,19



45028

45029

45030 D

Galvanizado industrial brillo. ALUZINC



Galvanizado en frío. Acabado brillo. Alta protección frente a la corrosión. Barrera compacta de protección para ofrecer a las piezas el mismo aspecto que las galvanizadas clásicas, después de pequeñas reparaciones. Secado extrarrápido, difusor abanico profesional.

Ref.	Código	Capacidad ml	€ / u.
1110800	1030753	500	12,70



Galvanizado en frío



Ref.	Código	Descripción	Capacidad ml	€ / u.
1131723	31723	GALVA FLASH	500	8,86
1131733	31733	GALVA Mate	500	8,86
1131743	31743	GALVA BRILLANT	500	8,86
1131713	31713	GALVA Inox	400	17,82



31723 31733 31743 31713

Imprimación de Zinc + color en un solo producto. GALVACOLOR



Galvanizado, acabado satinado, de zinc + color que proporciona larga protección anti-corrosión. Mínima preparación de la superficie. Fácil de aplicar. Test de niebla >200 h. Ideal para la identificación de conductos y/o tuberías. Período corto de secado. Colores de identificación RAL oficial según normativa de protección C3 (ISO 12944-2). Con disolventes no clorados. No contiene plomo ni cromados. Proteja los metales y las mezclas.

Ref.	Código	Color	RAL	Capacidad ml	€ / u.
1112010	1030359	Amarillo	1004	500	12,47
1112011	1030361	Rojo	3000	500	12,47
1112012	1030364	Azul	5012	500	12,47
1112005	1030370	Negro	9005	500	12,47
1112007	1030375	Plata	9006	500	12,47
1112008	1030380	Blanco	9010	500	12,47
21030001	1032713	Verde Musgo	6005	500	12,47



1030359 1030361 1030364 1030370 1030375 1030380 1032713

Galvanizado. GALVA SHINE



Galvanizado superbrillo. Una capa duradera, con el aspecto brillante de las aleaciones de Zinc modernas que son utilizadas en algunas plantas de galvanizado en caliente. CRC Galva Shine / Galva brillo es usado para retoques de piezas galvanizadas recién fabricadas que necesitan el aspecto estético de alto brillo durante una gran parte de su vida. Secado rápido.

Ref.	Código	Capacidad ml	€ / u.
8000405	1031388	500	7,85



Galvanizador en frío. ZINC SPRAY



Producto a base de zinc para el revestimiento de metales férricos, corrosionados debido a humedad, agua, salinidad y ambientes agresivos. Ante cualquier ruptura accidental del galvanizado electrolítico, en caliente o una metalización de zinc, podrá ser reparada con Zingrup B.

Ref.	Código	Capacidad ml	€ / u.
1116200	1650	400	5,97



Recubrimiento antioxidante de acero inoxidable. INOX 200



Contiene pigmentos metálicos de acero inoxidable, 17% Cr, 13% Ni, 2,25% Mo, 67,75% Fe. Excelente poder anticorrosivo. Protege la base metálica. No contiene plomo. Buen poder de cubrición. Secado ultrarrápido.



Ref.	Código	Capacidad ml	€ / u.
1110900	1031408	500	22,15

ACRYLIC PAINT ALTA TEMPERATURA



Se puede utilizar sobre metal, hierro fundido y aluminio. Para una resistencia total a la temperatura, el recubrimiento debe calentarse gradualmente de 160°C a 200°C y mantenerse a esa temperatura durante +/- 30 minutos. - Secado rápido: seco al polvo después de +/- 10 minutos - Resistente a temperaturas muy altas (hasta 800 °C) - Muy buenas propiedades de cubrición y relleno - Brillo duradero y color intenso - A prueba de arañazos - Resistente a la intemperie - Para uso en interiores y exteriores



Ref.	Código	Capacidad ml	€ / u.
21030031	1030662	400	10,74
21030032	1030896	400	10,74

ACRYLIC PAINT BARNIZ



Hace que la capa final sea aún más resistente a los agentes externos, como arañazos, golpes, luz (UV), corrosión... No solo ofrece una protección extra, sino que también da a su superficie un acabado brillante o mate para un acabado perfecto. - Secado rápido: seco al polvo después de +/- 10 minutos - Capa protectora para la pintura CRC Acrylic Paint - Acabado brillante o mate - Excelente adherencia - A prueba de golpes y arañazos - Resistente a la intemperie y a los rayos UV - Para uso en interiores y exteriores



Ref.	Código	Capacidad ml	€ / u.
21030035	1030217	400	6,71
21030036	1030885	400	6,71

ACRYLIC PAINT EFECTOS CROMADO



Se puede utilizar en todas las superficies lisas como metal, plásticos recubiertos, madera, vidrio... Aplique la imprimación CRC Acrylic Primer sobre superficies absorbentes para obtener un resultado óptimo. - Aspecto duradero similar al cromo pulido - Muy buena cubrición - Secado rápido: seco al polvo después de +/- 10 minutos - Resistencia al agua y a los productos de limpieza habituales - Adecuado para usar en una amplia variedad de superficies lisas - Para uso en interiores y exteriores



Ref.	Código	Capacidad ml	€ / u.
21030039	1030657	400	11,26

ACRYLIC PAINT IMPRIMACION METALES



Secado rápido: seco al polvo después de +/- 15 minutos. Alta capacidad de relleno. Protege ante la corrosión. Para uso en interiores y exteriores. Dirección y salida ajustables gracias a la boquilla flexible



Ref.	Código	Capacidad ml	€ / u.
21030033	1030891	400	10,55

ACRYLIC PAINT IMPRIMACIÓN PLASTICO



Secado rápido: seco al polvo después de +/- 15 minutos. Alta capacidad de relleno. Protege ante la corrosión. Para uso en interiores y exteriores. Dirección y salida ajustables gracias a la boquilla flexible

Ref.	Código	Capacidad ml	€ / u.
21030034	1032619	400	10,55



ACRYLIC PAINT EFECTOS METALIZADO



Se puede utilizar sobre una amplia variedad de superficies como metal, plásticos duros recubiertos, madera, piedra, vidrio, cartón, cerámica... • Brillo duradero y color intenso • Muy buena cubrición • Secado rápido: seco al polvo después de +/- 10 minutos • A prueba de golpes y arañazos • Adecuado para usar en una amplia variedad de superficies duras • Resistente a la intemperie cuando se recubre con el barniz CRC Acrylic Varnish • Para uso en interiores y exteriores

Ref.	Código	Capacidad ml	€ / u.
21030037	1030893	400	10,74
21030038	1030231	400	10,74



Soplador de polvo - DUST CLEANER



Gas inerte para eliminar el polvo de todo tipo de equipos de oficina e informáticos. Para uso en montajes electro-mecánicos, conjuntos eléctricos, componentes electrónicos, tarjetas de circuitos impresos, monederos electrónicos e instrumentos de precisión. Limpia, seca y no engrasa.

Ref.	Código	Capacidad ml	€ / u.
21030019	1031577	500	8,24



Limpiador desengrasante alto rendimiento. INDUSTRIAL ECO DEGREASER



Limpiador desengrasante enérgico para industria alimentaria. Gran potencia, alto rendimiento y evaporación rápida. Bajo olor. Nueva fórmula mejorada del Foodklean. Fácilmente biodegradable. Certificado NSF A8 y C1 para usar en industria alimentaria

Ref.	Código	Capacidad	€ / u.
21030003	1032701	500 ml	20,10
21030004	1032704	5 L	87,68
21030005	1032708	20 L	307,53



Soplador de polvo no inflamable. DUST FREE



Gas seco. Soplador de polvo no inflamable. Gas HFO. Bajo GWP. Eficiente mezcla de gas licuado a alta presión que elimina el polvo y limpia con un potente chorro de gas inerte seco. Previene fallos, periodos de parada y daños ocasionados por el polvo. No deja residuo o condensación. Diseñado para usar como limpiador de equipos eléctricos o electrónicos en áreas de procesado y no procesado de alimentos. NSF K2.

Ref.	Código	Capacidad ml	€ / u.
21030024	1032458	125	13,32



Soplador de polvo no inflamable



Gas seco. Soplador de polvo no inflamable. Gas HFO. Bajo GWP

Ref.	Código	Capacidad ml	€ / u.
21030025	1032381	250	25,91



Limpiador de óxido + lubricante para contactos eléctricos. CONTACT CLEANER PLUS&PROTECT



Limpieza, desoxidación, lubricación y protección de contactos eléctricos. Seguro en plásticos y gomas. Proporciona una lubricación de larga duración y es seguro de usar en todas las superficies de metal, la mayoría de gomas, plásticos y revestimientos. Producto con válvula 360°

Ref.	Código	Capacidad ml	€ / u.
1100250	1754386	500	19,95



3M™ Limpiador Industrial



Los limpiadores industriales y eliminadores de adhesivos 3M™ son ideales para ayudar a disolver y eliminar suciedad, grasa, alquitrán y diversos adhesivos que no curan. Limpian sin dejar manchas y se ha probado su excelente eficacia a la hora de preparar superficies en aplicaciones adhesivas. Estos limpiadores multiusos son adecuados para uso industrial, aunque también son suficientemente seguros para proyectos cotidianos.

Ref.	Código	Capacidad ml	€ / u.
21003188	7100178336	200	16,96
21003189	7100178338	500	34,49



7100178336



7100178338

Limpiador de óxido + lubricante para contactos eléctricos. OXIDE CLEAN PLUS



NO INFLAMABLE. Limpieza, desoxidación, lubricación y protección de contactos eléctricos. Seguro en plásticos y gomas. Proporciona una lubricación de larga duración y es seguro de usar en todas las superficies de metal, la mayoría de gomas, plásticos y revestimientos. Producto con válvula 360.

Ref.	Código	Capacidad ml	€ / u.
21030020	1032531	250	47,70



Limpiador desengrasante en espuma de gran potencia, biodegradable.



Desengrasante en espuma, base agua, biodegradable y de alto rendimiento. Elimina grasa, aceite, resina y residuos secos de cualquier superficie lavable. Estable, fórmula anti-goteo: ideal para superficies verticales. Registro NSF - A1.

Ref.	Código	Capacidad ml	€ / u.
21030026	1030086	500	17,14



Limpiador de acero inoxidable, aluminio, cromados y PVC. INOX KLEEN FPS



Limpiador de acero inoxidable, aluminio, cromados y PVC. NSF certificado alimentación - A7, C1. Espuma limpiadora base agua para metales brillantes. Elimina y previene las huellas dactilares y las marcas de agua. El producto combina un alto poder de limpieza con la aplicación de una capa protectora duradera en un solo paso. Producto con válvula 360°



Ref.	Código	Capacidad ml	€ / u.
1100255	1030407	500	13,40

Lavaparabrisas ANTI-LLUVIA



Lavaparabrisas con efecto repelente

Ref.	Código	Descripción	Capacidad L	€ / u.
2402873	14126	Lavaparabrisas	5	11,36



Lavaparabrisas



Lavaparabrisas

Ref.	Código	Descripción	Capacidad L	€ / u.
2402874	14976	Lavaparabrisas	5	10,76



Desengrasante de evaporación rápida



Desengrasante de evaporación rápida. Residuo 0. Limpiador de secado rápido para suciedad fuertes en piezas mecánicas, adecuado para la mayor variedad de plásticos. Producto con válvula 360

Ref.	Código	Capacidad	€ / u.
8000385	1030077	500 ml	11,63
8000386	1030081	5 L	48,43



1030077



1030081

Desengrasante para motores eléctricos. LECTRA CLEAN II



Desengrasante energético para motores eléctricos. Evaporación lenta. Alto punto de inflamación para mayor seguridad. Residuo 0. Limpiador energético para suciedad fuerte en piezas mecánicas y motores eléctricos. La evaporación controlada permite al producto actuar durante mayor tiempo y disolver suciedad muy fuerte. Adecuado para limpieza por inmersión y mediante ultrasonidos. Producto con válvula 360

Ref.	Código	Capacidad	€ / u.
8000387	1030624	500	19,10
8000388	1030104	5	85,20



1030624



1030104

Limpiador desengrasante de frenos



Limpiador desengrasante de frenos. Elimina restos de ferodo. Súper enérgico con alta presión. Rápida evaporación. No ataca plásticos

Ref.	Código	Capacidad	€ / u.
2402871	1031695	500 ml	4,85
2402870	1031911	5 L	34,15
2402869	1031874	20 L	124,27
2402872	1031913	60 L	283,00



Decapante de soldadura. INOX WELD KLEEN



Decapante de soldadura inoxidable. Restable las características originales del acero inoxidable tras la soldadura. Desengrasante, limpiador, decapante y pasivador de austenita y acero inoxidable 303, 304, 316, ..., níquel y aluminio. Rápido de aplicar, muy eficiente, económico y práctico de usar.

Ref.	Código	Capacidad Kgr.	€ / u.
8000390	1030588	2	58,84



Limpiador de contactos NO INFLAMABLE. NF ELECTRONIC CLEANER



Limpiador de contactos. Limpiador de precisión no inflamable para componentes eléctricos o electrónicos. Para limpieza y desengrase de todo tipo de componentes eléctricos y electrónicos donde una parada del equipo es imposible o supone un alto coste. CRC N.F. Electronic Cleaner no contienen disolventes clorados, CFCs ni HCFCs; base disolvente, de secado rápido. Producto con válvula 360.

Ref.	Código	Capacidad ml	€ / u.
8000389	1032386	250	47,65



Limpiador profesional de óxido y cal en metales ferrosos. FERROKLEEN PRO



Limpieza profesional de superficies pintadas o sin revestimiento, contaminadas con óxido, cal, aceite y alquitrán. No ataca a la pintura. Fórmula en espuma ligera. Base agua, no inflamable. Compuesto de >90% de componentes inorgánicos y componentes orgánicos biodegradables. No clasificado como peligroso para el medio ambiente.

Ref.	Código	Denominación	Capacidad kg	€ / u.
1130088	1030449	Ferrokleen-Limpiaoxido	1	12,31
1130089	1030444	Ferrokleen Pro	5	51,21
1130199	1030469	Ferrokleen Pro	20	174,06



Eliminador de restos de azúcar y derivados - SUGAR DISSOLVING FLUID



Elimina eficazmente residuos a base de azúcar y restos caramelizados de cualquier equipo. El aceite lubricante ligero que queda después del uso inhibe la posterior adhesión de residuos. Con certificado alimentario NSF - H1 para usar en industria alimentaria

Ref.	Código	Capacidad L	€ / u.
21030030	1030471	5	51,78



Desengrasante universal, base agua. COMPLEX BLUE FPS



Desengrasante universal. Base agua. Concentrado. Desengrasante a presión, con vapor, por ultrasonidos, etc. Con certificación NSF A1, para usar in industria alimentaria. Biodegradable. Ph: 11. Dilución 1:100

Ref.	Código	Denominación	Capacidad L	€ / u.
1110205	1030087	Eco Complex Blue Fps	5	33,60
1110207	1030259	Eco Complex Blue Fps	20	107,52
1110208	1030621	Complex Blue Fps	200	806,40



Desengrasante alcalino. D-15



Desengrasante alcalino concentrado. Tiene propiedades dispersantes, humectantes y secuestrantes. Elimina todo tipo de suciedades aceitosas y grasientas sin dejar residuos ni película aceitosa

Ref.	Código	Capacidad L	€ / u.
8004821	1010/5	5	18,75
8004820	1010/25	25	93,75
8004822	1010/50	50	187,50



Desengrasante universal ph neutro. D-15 B



Elimina todo tipo de suciedades aceitosas o grasientas sin dejar residuos. Recomendado para el desengrase de campanas extractoras, hornos, filtros, suelos de cocina, maquinaria, containers de camiones, etc...

Ref.	Código	Capacidad L	€ / u.
1106700	1620	5	30,25
1106701	1621	25	151,25
1106702	1622	50	302,50



Desengrasante



Limpia y desengrasa rápida y eficazmente.

Ref.	Código	Descripción	Capacidad ml	€ / u.
1137243	37243	Desengrasante STEC	500	13,06



Desengrasante industrial - INDUSTRIAL DEGREASER



Desengrasante industrial. Evaporación total. No deja residuo. Suave olor. NSF - Certificado alimentación - A8, K1. Limpiador base disolvente para suciedad fuerte en piezas mecánicas. Limpiador enérgico de evaporación media con un punto de inflamación de 25 °C. Elimina grasas, aceite, lubricantes, adhesivos no curados y suciedad de los equipos, maquinaria y piezas mecánicas. Producto con válvula 360

Ref.	Código	Capacidad	€ / u.
1100260	1030109	500 ml	16,78
1100261	1030114	5 L	67,80
1100262	1030116	20 L	235,80



Profesional desengrasante



El Super Desengrasante 3-EN-UNO Profesional elimina rápidamente aceites, grasas, alquitrán, salitre y todo tipo de suciedad, sin necesidad de enjuague o secado. Compatible con todo tipo de plásticos, metales y pinturas de superficie. Actúa y seca rápidamente y sin dejar residuo en todo tipo de piezas mecánicas, herramientas, cadenas y motores.



Ref.	Código	Capacidad ml	€ / u.
21001000	34472	250	8,88

WD-40 Specialist desengrasante



ACCIÓN RÁPIDA. Libera piezas y mecanismos, incluso los fuertemente corroídos o atascados por acumulación del óxido. Desbloquea tuercas oxidadas de las llantas de vehículos. Libera tuercas de tornillos bloqueados y corroídos. NSF H2. Pulverizador doble acción.



Ref.	Código	€ / u.
1113084	34392	11,56

Sellador de silicona ácida ORBASIL K-91



Sellador de silicona ácida de altas prestaciones. Elasticidad permanente. Juntas elásticas y duraderas. Resistente a la intemperie y envejecimiento. Excelente adhesión a vidrio, aluminio, azulejos, cerámica, superficies vitrificadas y otras superficies no porosas. Sellados en acristalamientos. Sellados en estructuras metálicas, mostradores, vitrinas y escaparates. Fabricación de pequeños acuarios, elementos de refrigeración, ventilación y aire acondicionado.



Ref.	Código	Descripción	€ / u.
1100265	10043784	Translucido 300 ml	4,41
1100266	10043799	Blanco 300 ml	4,41
1100267	10043785	Aluminio 300 ml	4,41

Silicona Acética Universal 360



Silicona acética sanitaria antimoho, elástica y que no ennegrece. Resistente a los rayos UV



Ref.	Código	Descripción	€ / u.
2402875	H40082	Blanco 300 ml	3,59
2402876	H40087	Transparente 300 ml	3,59
2402877	H40084	Gris 300 ml	3,59
2402878	H40085	Negro 300 ml	3,59
2402879	H40081	Gris Alu 300 ml	3,59
2402880	H40083	Bronce 300 ml	3,59

Sellador de silicona ácida ORBASIL K-86 uso general



Sellador de silicona ácida de uso general. Resistente al moho. Resistente a la intemperie y envejecimiento. Evita filtraciones de aire, agua y polvo. Excelente adherencia sobre vidrio, aluminio, cerámica, azulejos, superficies vitrificadas y otros materiales no porosos. Sellado de acristalamiento, sellado vidrio-carpintería de aluminio. Sellado en baños y cocinas.

Ref.	Código	Descripción	€ / u.
1100275	10043803	Translucido 300 ml	4,04
1100276	10043806	Blanco 300 ml	4,04
1100277	10043804	Aluminio 300 ml	4,04
1100278	10043805	Bronce 300 ml	4,04
1100279	10043801	Gris 300 ml	4,04
1100280	10043802	Negro 300 ml	4,04



Silicona Acética S-11 de curado rápido



Silicona acética sanitaria antimoho, elástica y que no ennegrece. Resistente a los rayos UV

Ref.	Código	Descripción	€ / u.
2402881	H40305	Blanco 300 ml	6,17
2402882	H40304	Transparente 300 ml	6,17



Sellador de silicona ácida SINTEX MS-35



Sellador de silicona ácida de uso general Resistente al moho. Resistente a la intemperie y envejecimiento. Evita filtraciones de aire, agua y polvo. Excelente adherencia sobre vidrio, aluminio, cerámica, azulejos, superficies vitrificadas y otros materiales no porosos. Sellado de acristalamiento, sellado vidrio-carpintería de aluminio. Sellado en baños y cocinas.

Ref.	Código	Descripción	€ / u.
1100285	10043798	Blanco 300 ml	6,65
1100286	10043791	Gris 300 ml	6,65
1100287	10042929	Marrón 300 ml	6,65
1100288	10043797	Negro 300 ml	6,65



Silicona industrial. SILKRON SPG



Silicona industrial ácida monocomponente, especialmente formulada para la formación de juntas in situ.

Ref.	Código	Capacidad ml	Formato	€ / u.
1107801	54293	300	Cartucho	29,99



Silicona Acética 600 para sellar acristalamientos



Silicona 100% acética para sellar acristalamientos, de alta calidad y excelentes prestaciones que forma una junta estanca elástica y muy resistente en reacción con la humedad atmosférica.

Ref.	Código	Descripción	€ / u.
2402883	H40077	Transparente 300 ml	8,09
2402884	H40073	Blanco 300 ml	8,09
2402885	H40075	Negro 300 ml	8,09
2402886	H40074	Marrón 300 ml	8,09
2402887	H40076	Oro 300ml	8,09



Sellador de silicona baños y cocinas resistente al moho



Sellador de silicona ácida sanitaria resistente al moho. Protege las superficies y previene activamente la formación de moho y el ennegrecimiento. Secado rápido. Impermeabiliza herméticamente evitando filtraciones y resistiendo a la humedad, temperatura y productos de limpieza. Sellado de juntas en baños y cocinas (lavabos, bañeras, duchas, encimeras, mamparas, fregaderos, sanitarios, etc.) Cánula multiposición para la aplicación en lugares de difícil acceso.



Ref.	Código	Descripción	€/u.
1100290	10043497	Blanco 300 ml	4,50
1100291	10043496	Transparente 300 ml	4,50

Silicona ácida



Sellador de silicona ácida de uso general con fungicida. Sellado de acristalamiento, vidrio, carpintería, baños y cocinas. Capacidad: 280 ml.



Ref.	Código	Capacidad ml	Color	€/u.
1107400	80973	280	Blanco	2,95
1107401	80963	280	Translúcido	2,95

Silicona industrial. SILKRON SPG



Silicona industrial ácida monocomponente, especialmente formulada para la formación de juntas in situ.



Ref.	Código	Capacidad ml	Formato	€/u.
2402888	54291	75	Tubo	11,81
2402889	54292	200	Tubo	37,89

Silicona neutra. SILKRON HT



Silicona industrial neutra de alto rendimiento para alta temperatura (desde -60 °C hasta +300 °C en continuo y +350 °C en punta).



54281

54283

Ref.	Código	Capacidad ml	Color	Formato	€/u.
1107900	54281	75	Rojo	Tubo	11,59
1107901	54283	300	Rojo	Cartucho	28,41
1107904	54183	300	Negro	Cartucho	28,41

Sellador de silicona neutra ORBASIL N-26



Sellador de silicona neutra de máximas prestaciones para construcción. Máxima resistencia a la intemperie y Rayos UV. Máxima Elasticidad y Adhesión. Materiales porosos y no porosos: hormigón, ladrillo, madera, cerámica, superficies vitrificadas, aluminio, aluminio lacado, acero, acero galvanizado, superficies pintadas y una gran variedad de plásticos. Sellado de ventanas en general, carpintería-obra, vidrio-carpintería y carpintería entre sí. Sellado de elementos de PVC. Juntas de dilatación en fachadas Marca N de Aenor. Certificado ISO11600, F+G 25 LM.



Ref.	Código	Descripción	€/u.
1100295	10043788	Traslucido 300 ml	5,11
1100296	10043808	Blanco 300 ml	5,10
1100297	10042655	Blanco laca 300ml	5,10



Silicona neutra



Silicona neutra de alto rendimiento. Sellado de juntas, acristalamiento y carpintería.

Ref.	Código	Descripción	€/u.
1115300	70923	Translúcido 300 ml	4,43
1115301	70913	Blanco 300 ml	4,43



Sellador de silicona neutra ORBASIL N-25



Sellador de silicona neutra de máximas prestaciones para aplicaciones en construcción. Amplia gama de colores. Excelente adherencia sobre materiales porosos y no porosos. Máxima adherencia y elasticidad. Máxima resistencia a UV e intemperie. Color permanente. Sellado en construcción, acristalamiento y ventanas (PVC, Madera, Aluminio, Aluminio Lacado). Juntas de Dilatación en Fachadas. Marca N de Aenor. Certificado ISO11600, F+G 25 LM.



Ref.	Código	Descripción	€/u.
1100310	10043426	Blanco pireneo 300 ml	5,08
1100311	10043427	Blanco pvc 300 ml	4,59
1100312	10043428	Bronce 300 ml	4,59
1100313	10042998	Crema 300 ml	5,08
1100314	10042999	Gris perla 300 ml	5,08
1100315	10043000	Inox 300 ml	4,59
1100316	10043429	Ladrillo 300 ml	5,08
1100317	10043001	Marron pu 300 ml	5,08
1100319	10043004	Plata 300 ml	4,59
1100320	10042922	Ral 1013 beige 300 ml	5,08
1100321	10042509	Ral 1015 beige 300 ml	5,08
1100322	10043908	Ral 3005 rojo 300 ml	5,08
1100324	10043910	Ral 5010 azul 300 ml	5,08
1100325	10042704	Ral 6005 verde 300 ml	5,08

Ref.	Código	Descripción	€/u.
1100326	10043917	Ral 6009 verde 300 ml	5,08
1100327	10043431	Ral 7021 gris negro 300 ml	4,59
2402890	10043151	Ral 7011 gris 300 ml	5,08
1100328	10043826	Ral 7016 300 ml	4,59
1100329	10043432	Ral 7022 gris 300 ml	4,59
1100330	10043433	Ral 7024 gris 300 ml	5,08
1100331	10043434	Ral 8014 marron 300 ml	4,59
1100332	10043435	Ral 8017 300 ml	5,08
1100333	10042385	Ral 9006 aluminio 300 ml	4,59
1100334	10042613	Ral 9007 300 ml	5,08
1100335	10043436	Ral 9023 aluminio 300 ml	5,08
1100336	10043005	Roble 300 ml	5,08
1100337	10043094	Roble dorado 300 ml	4,59
1100338	10043006	Sapelly 300 ml	5,08

Silicona neutra Ventanas C-22 de máxima elasticidad



Silicona neutra para ventanas de máxima elasticidad, alta calidad y de bajo módulo, flexible y extremadamente resistente.

Ref.	Código	Descripción	€/u.
2402891	H40112	Transparente 300ml	7,15
2402892	H40111	Blanco 300 ml	7,15



Silicona neutra C-27 Construcción multimalteriales



Silicona neutra de alta calidad y de bajo módulo, que forma una junta flexible extremadamente resistente.

Ref.	Código	Descripción	€/u.
2402893	H40173	Transparente 300ml	6,09
2402894	H40164	Blanco 300 ml	6,09



Sellador de silicona neutra baños



Silicona neutra con fungicida de calidad premium [sellador 100%]

Ref.	Código	Descripción	€/ u.
2402895	10042889	Blanco 280 ml	6,77
2402896	10042895	Crema 280 ml	6,18
2402897	10042893	Translúcido 280 ml	6,77



Silicona neutra C-25 para sellados generales



Silicona neutra para acristalamientos de bajo módulo, que reacciona con la humedad atmosférica formando una junta flexible extremadamente resistente.

Ref.	Código	Descripción	€/ u.
2402898	H40161	Transparente 300ml	6,56
2402899	H40160	Blanco 300 ml	6,56
2402900	H40277	Gris Alu 300 ml	6,56
2402901	H40278	Negro 300 ml	6,56



Adhesivo-Sellador ORBASIL N-32



Adhesivo-Sellador de silicona neutra para espejos. No ataca al Espejo. Alta Resistencia, alto módulo, juntas flexibles y ultra fuertes. Absorbe movimientos entre el panel y el sustrato. Pegado y sellado de espejos y paneles interiores sobre diferentes materiales.

Ref.	Código	Descripción	€/ u.
1100340	10042233	Traslúcido 300 ml	6,54
1100341	10042234	Blanco 300 ml	6,54



Sellador de silicona neutra



Sellador de silicona neutra

Ref.	Código	Color	Capacidad ml	€/ u.
2402902	2844234	Tranlúcido	280	7,95
2402903	2844055	Blanco	280	7,95



Sellador de silicona neutra. PATTEX SL650 ventanas y juntas



Sellador de silicona neutra

Ref.	Código	Color	Capacidad ml	€/ u.
21048024	1533288	Negro	300	12,42
21048025	1533278	Tranlúcido	300	12,42
21048026	1533276	inox	300	12,42
21048027	1533275	Plata	300	12,42
21048028	1533269	Bronce	300	12,42
21048029	1533272	RAL 7022	300	12,42



Silicona neutra. SILKRAF ESPEJOS



Silicona neutra de alto módulo especial para el pegado de espejos. No ataca al esmalte

Ref.	Código	Capacidad ml	€ / u.
2402904	53663	300	11,27



Silicona neutra. NONFIRE IGNIFUGA



Silicona neutra ignífuga. Especial para protección pasiva contra el fuego. Clasificada EI/RF 240 y M2

Ref.	Código	Capacidad ml	€ / u.
2402905	54063	300	9,94



Silicona neutra. NONFIRE ALTA



Silicona neutra resistente a temperaturas extremas (hasta +350°C). Rango de temperaturas desde -60°C hasta +310°C en continuo

Ref.	Código	Capacidad ml	€ / u.
2402906	54053	300	14,64



Silicona neutra. SILKRAF NEUTRO



Silicona neutra profesional de altas prestaciones. Resistente a los rayos UV y agentes atmosféricos.

Ref.	Código	Capacidad ml	€ / u.
2402907	62693	300	6,28



Sellador de silicona neutra ORBASIL N-9 Construcción



Sellador de silicona neutra de uso general en construcción. Resistente a la intemperie y rayos UV. Buena adherencia sobre los materiales de la construcción, tanto porosos como no porosos. Sellado de juntas estáticas y de dilatación. Para interiores y exteriores. Sellados en acristalamientos, ventanas y puertas.

Ref.	Código	Descripción	€ / u.
1100345	10043419	Blanco 300 ml	3,75
1100346	10043421	Blanco lara 300 ml	3,75
1100347	10043422	Gris 300 ml	3,85
1100348	10043423	Negro negro 300 ml	3,85
1100349	10043420	Transparente 300 ml	3,75



Silicona líquida. RUBSON SL3000



Revesitimiento Estanco Universal. Máxima elasticidad. Alta resistencia UV.
100% Estanco. Capacidad de relleno. Fácil de aplicar.

Ref.	Código	Capacidad kg	Color	€ / u.
1540593	1890700	1	Negro	30,46
1139782	1139782	5	Negro	122,11
1139769	1890693	1	Gris	30,46
1139781	1139781	5	Gris	122,11
1138469	1138469	25	Gris	458,33
1449360	1894877	1	Teja	30,46
1326031	1326031	5	Teja	122,11
1540607	1894876	1	Blanco	30,46
1396742	1396742	5	Blanco	122,11



Sellador en base acuosa SINTESEL madera



Sellador en base acuosa para juntas en madera. Pintable y barnizable. Amplia gama de colores de madera. Buena adhesión sobre la mayoría de los materiales de construcción. Acabado brillante. Interior y exterior. Sellado de juntas entre piezas de madera (parquet, rodapiés, zócalos, armarios, etc.). Sellado de juntas entre madera y construcción (puertas, ventanas, etc.).



Ref.	Código	Descripción	€ / u.
1100370	10043711	Cerezo 300 ml	3,84
1100371	10043712	Haya 300 ml	3,84
1100372	10043713	Nogal 300 ml	3,84
1100373	10043714	Pino 300 ml	3,84
1100374	10043716	Roble 300 ml	3,84
1100375	10043715	Sapelly 300 ml	3,84

Ref.	Código	Descripción	€ / u.
1100376	10043717	Wengue 300 ml	3,84
1100377	10043708	Blanco 300 ml	3,84
1100378	10043709	Roble gris claro 300ml	3,84
1100379	10043710	Roble gris oscuro 300ml	3,84
2402908	10042686	Castaño 150 ml	3,84
2402909	10042685	Lino Cancún 150 ml	3,84

Sellador acrílico SINTEX AC-47



Sellador acrílico de uso general para juntas de bajo movimiento en hormigón, piedra, ladrillo, madera. Pintable y barnizable. Fácil aplicación y limpieza. Buena adherencia en materiales porosos de construcción, ladrillo, yeso, hormigón, madera, piedra. Interior y exterior. Grietas en fachada y pared. Sellado de cajas de persianas, marcos de puertas y ventanas. Juntas de bajo movimiento.

Ref.	Código	Descripción	€ / u.
1100390	10043771	Blanco 300 ml	2,12
1100391	10043772	Gris 300 ml	2,12
2402910	10043133	Blanco nítido 300 ml	2,39
1100392	10043775	Ladrillo 300 ml	2,39
1100394	10043774	Negro 300 ml	2,39



Sellador MS Especial Platos Ducha



No genera moho, multiplateral, especial para pegado, sellado y remates.
Secado en 4 horas.

Ref.	Código	Capacidad ml	€ / u.
2402911	568487	300	11,07



Sellador acrílico D-70



Masilla acrílica plasto-elástica para sellar juntas y grietas que cura por evaporación de agua, sin olor, fácil de aplicar y de limpiar.

Ref.	Código	Descripción	€ / u.
2402912	H40004	Blanco 300 ml	3,30
2402913	H40006	Marrón 300 ml	3,30
2402914	H40008	Rojo 300 ml	3,30

Ref.	Código	Descripción	€ / u.
2402915	H40005	Gris 300 ml	3,30
2402916	H40007	Negro 300 ml	3,30



Sellador acrílico D-80 para maderas



Sellante de juntas de madera plastoelástico de gran calidad a base de dispersiones de acrílico siliconizado. Pintable tras su curado.

Ref.	Código	Descripción	€ / u.
2402917	H40015	Nogal 300 ml	4,99
2402918	H40011	Cerezo 300 ml	4,99
2402919	H40010	Caoba 300 m	4,99
2402920	H40017	Roble oscuro 300ml	4,99
2402921	H40014	Haya 300 ml	4,99

Ref.	Código	Descripción	€ / u.
2402922	H40012	Gris claro 300ml	4,99
2402923	H40013	Gris 300 ml	4,99
2402924	H40016	Pino 300 ml	4,99
2402925	H40018	Sapeli 300ml	4,99
2402926	H40019	Wengue 300 ml	4,99



Sellador acrílico en dispersión acuosa



Ideal para juntas de bajo movimiento. Indicado para el sellado de grietas, fisuras, ventanas y marcos.

Ref.	Código	Descripción	Capacidad ml	Color	€ / u.
21048030	1536078	Pattex Acril 1 Paredes y grietas 300ml Blanco	300	Blanco	3,68





Sellador PU. POLIFLEX PLUS

Para el sellado de juntas de dilatación interiores y exteriores, sellado de grietas y fisuras, sellado uniones de marcos y ventanas, sellado de juntas de pavimentos, pegado y sellado de canalones. Cartucho de 300 ml.



Ref.	Código	Descripción	Formato	€ / u.
1108600	50013	Gris	Cartucho 300 ml	4,86
1108601	50023	Blanco	Cartucho 300 ml	4,86
1108602	50033	Negro	Cartucho 300 ml	4,86
1108603	50043	Marrón	Cartucho 300 ml	4,86
1108608	50014	Gris	Salchicha 600 ml	7,91
1109609	50024	Blanco	Salchicha 600 ml	7,91
1109610	50034	Negro	Salchicha 600 ml	7,91
1109611	50044	Marrón	Salchicha 600 ml	7,91

Hidrorepelente para fachadas/tejados



Proporciona una protección de larga duración en materiales absorbentes, tanto alcalinos como cerámicos. Forman una barrera impermeable en los materiales. Es un hidrofugante líquido incoloro para fachadas y tejados, que repele el agua manteniendo el aspecto natural de la superficie. Ideal para proteger paredes exteriores de ladrillo, piedra o tejados, monumentos y materiales porosos que se pretendan impermeabilizar manteniendo su aspecto original.



Ref.	Código	Descripción	€ / u.
1100241	10042179	Transparente 5 L	39,98
1100242	10042459	Transparente 25 L	163,00

Ref.	Código	Descripción	€ / u.
1100243	10042180	Transparente 750 ml	12,90
1100244	10042181	Transparente 5 L	69,29

Hidrorepelente para fachadas/tejados



Membrana impermeabilizante elástica basada en tecnología MS y que permite transitable constante con 25 años de garantía certificada



Ref.	Código	Descripción	€ / u.
2402927	10043683	Gris 1 Kg	23,00
2402928	10043684	Terracota 1 Kg	23,00
2402929	10043398	Terracota 5 Kg	109,73

Ref.	Código	Descripción	€ / u.
2402930	10043424	Gris 20 Kg	385,40
2402931	10043442	Terracota 20 Kg	385,40

Hidrorepelente para fachadas/tejados



Membrana líquida en base acrílica reforzada con microfibras diseñada para impermeabilizar cubiertas planas, terrazas y balcones con 15 años de garantía certificada



Ref.	Código	Descripción	€ / u.
2402932	10042026	Gris 1 Kg	5,93
2402933	10042025	Terracota 1 Kg	5,93
2402934	10042024	Gris 5 Kg	23,05

Ref.	Código	Descripción	€ / u.
2402935	10042023	Terracota 5 Kg	23,05
2402936	10041628	Gris 20 Kg	83,95
2402937	10041630	Terracota 20 Kg	83,95

Revestimiento elástico AQUA PROTECT



Revestimiento elástico, basado en tecnología MS, listo para usar, de curado a temperatura ambiente en contacto con la humedad del aire, para la impermeabilización y reparación de cubiertas. Aplicable en superficies húmedas, resiste a la intemperie y a los rayos UV. Sin merma y sin disolventes. Alta capacidad de relleno y alta elasticidad (400%). No gotea ni descuelga, pintable y transitable.



Ref.	Código	Descripción	€ / u.
1100350	10043741	Blanco 1kg	20,95
1100351	10042281	Gris 1kg	20,95
1100352	10042284	Negro 1kg	20,95
1100353	10042282	Terracota 1kg	20,95
1100354	10043742	Blanco 5kg	85,00
1100355	10042285	Gris 5kg	85,00

Ref.	Código	Descripción	€ / u.
1100356	10042287	Negro 5kg	85,00
1100357	10042286	Terracota 5kg	85,00
1100358	10042271	Blanco 25kg	379,84
1100359	10042291	Gris 25kg	379,84
1100361	10042296	Terracota 25kg	379,84

ECOFIRE INDUSTRY



Recomendado para incendios de concentración. Su mayor densidad favorece su adherencia. 100% ecológico, biodegradable y orgánico. Agente de extinción y prevención de incendios, inocuo para el ser humano y animales. Actúa como aislante térmico, no transmite el calor. Sistemas sencillos de aplicación como pulverizadores, mochila de extinción o un equipo autónomo de extinción. Barrera preventiva contra el fuego, actúa como cortafuegos. Extinción total del fuego, no se vuelve a reactivar una vez apagado. Corta el humo de forma inmediata, evitando intoxicación. Evita la propagación del fuego, perfecto ante cambios climatológicos y vientos. Entre 50 y 100 veces más rápido que el agua. Se necesita poca cantidad para extinguir el fuego: 1 litro de Ecofire equivale a 20 litros de agua.



Ref.	Código	Capacidad ltrs.	€ / u.
2402939	ECOFIRE INDUSTRY 1000 L.	1.000	7.043,57
2402940	ECOFIRE INDUSTRY 5 L.	5	66,44
2402938	ECOFIRE INDUSTRY 1 L.	1	21,91

ECOFIRE FOREST



Recomendado para incendios de concentración. Su mayor densidad favorece su adherencia. 100% ecológico, biodegradable y orgánico. Agente de extinción y prevención de incendios, inocuo para el ser humano y animales. Actúa como aislante térmico, no transmite el calor. Sistemas sencillos de aplicación como pulverizadores, mochila de extinción o un equipo autónomo de extinción. Barrera preventiva contra el fuego, actúa como cortafuegos. Extinción total del fuego, no se vuelve a reactivar una vez apagado. Corta el humo de forma inmediata, evitando intoxicación. Evita la propagación del fuego, perfecto ante cambios climatológicos y vientos. Entre 50 y 100 veces más rápido que el agua. Se necesita poca cantidad para extinguir el fuego: 1 litro de Ecofire equivale a 20 litros de agua.



Ref.	Código	Capacidad ltrs.	€/ u.
2402941	ECOFIRE FOREST 5 L.	5	60,85
2402942	ECOFIRE FOREST 1000 L.	1	6.549,40

Sellador adhesivo MS 1000 Usos pega-sella todo



Sellador adhesivo de polímero MS acabado cristal. SUPER Transparente. Todos los materiales. Elástico: Absorbe vibraciones y movimientos de dilatación y contracción. Adhiere incluso sobre superficies húmedas. Eficaz sobre la mayoría de los materiales: cristal, metacrilato, ladrillo, cemento, hierro, chapa, aluminio, zinc, poliestireno, madera, cerámica, tejas, hormigón, PVC. Resistente a la intemperie y temperatura (-40°C +90°C). Resistente al moho. Sin olor. Exento de sustancias peligrosas. Cánula multiposición para la aplicación en lugares de difícil acceso. SELLADO: Todo tipo de juntas en construcción, vidrio, baños, tuberías, claraboyas. PEGADO: Fijación de piezas de cristal, metálicas y metacrilato, plástico, mamparas.



Ref.	Código	Descripción	€/ u.
1100396	10042743	Blanco 280 ml	7,04

Adhesivo de montaje. Pattex NMC



Ref.	Código	Descripción	Características	€/ u.
1793314	1952431	Pattex NMC Tubo 150 gr.	Agarre inicial: 10 seg. Resultados extra fuertes.	8,86
1793309	1952387	Pattex NMC Tubo 250 gr.	Agarre inicial: 10 seg. Resultados extra fuertes.	12,53
1755216	1955998	Pattex NMC Cart. 370 gr.	Agarre inicial: 10 seg. Resultados extra fuertes.	12,24
1792947	1952453	Pattex NMC Invisible Tubo 200 gr.	Agarre inicial: 10 seg. No más manchas. No más restos de producto.	12,20
1792949	1916008	Pattex PL Premium wh 460gr.	Agarre inmediato (hasta 350Kg/m2)	11,51
1793317	1669710	Power Tape 50x25m Gris	Esta cinta adhesiva es capaz de soportar cargas de hasta 120 kg por metro cuadrado	16,83

Sellador adhesivo MS 1000 Usos pega-sella todo



Sellador adhesivo de polímero MS acabado cristal. SUPER Transparente. Todos los materiales. Elástico: Absorbe vibraciones y movimientos de dilatación y contracción. Adhiere incluso sobre superficies húmedas. Eficaz sobre la mayoría de los materiales: cristal, metacrilato, ladrillo, cemento, hierro, chapa, aluminio, zinc, poliestireno, madera, cerámica, tejas, hormigón, PVC. Resistente a la intemperie y temperatura [-40°C +90°C]. Resistente al moho. Sin olor. Exento de sustancias peligrosas. Cánula multiposición para la aplicación en lugares de difícil acceso. SELLADO: Todo tipo de juntas en construcción, vidrio, baños, tuberías, claraboyas. PEGADO: Fijación de piezas de cristal, metálicas y metacrilato, plástico, mamparas.



Ref.	Código	Descripción	€/u.
1100396	10042743	Blanco 280 ml	7,04
2402943	10036018	Transparente 280 ml	7,30

Polymer MS-35 Pega y Sella



Pega y sella multimaterial a base de polímeros MS, elástico certificado, de curado rápido en contacto con la humedad atmosférica. Resistente a la intemperie y los rayos UV. Pega y sella en superficies húmedas e incluso bajo el agua.



Ref.	Código	Descripción	€/u.
2402944	H40065	Blanco 300 ml	8,74
2402945	H40066	Gris 300 ml	8,74
2402946	H40068	Negro 300 ml	8,74
2402947	H40067	Marrón 300 ml	8,74
2402948	H40069	Terracota 300 ml	8,74
2402949	H40064	Beige 300 ml	8,74

Polymer MS-35 Crystal



Pega y sella híbrido totalmente transparente, a base de polímero MS, elástico, de curado rápido. Pega incluso bajo el agua.



Ref.	Código	Descripción	€/u.
2402950	H40070	Transparente 300 ml	10,95

Adhesivo de montaje sin disolventes. FIX EXPRESS



Ref.	Código	Descripción	€/u.
1100410	10024498	Cartucho 375 ml	5,62
1100411	10043587	Tubo Blanco 250 grs	4,04
2402951	10044776	Biberón 300 ml	20,82



Polymer MS Turbo

PENOSIL

Adhesivo elástico y neutro de potencia extrema, a base de polímero MS, de agarre inmediato y altas prestaciones finales. Excelente adhesión en la mayoría de los soportes, incluso en superficies húmedas, lo que permite pegar y fijar casi todos los materiales tanto en interior como en exterior, para obtener uniones rápidas, elásticas, fuertes y duraderas, en la construcción y en la industria.



Ref.	Código	Descripción	€/u.
2402952	24377022C05N22	Negro 300 ml	10,15
2402953	24377022C05F03	Blanco 300 ml	10,15
2402954	24377022C05K83	Gris 300 ml	10,15
2402955	24377022C05R40	Terracota 300 ml	10,15

Espuma pistola

sinex

Espuma de poliuretano para aplicar con pistola 750 ml.



Ref.	Código	Capacidad ml	€/u.
13124766	23124766	750	6,00

Espuma cánula

sinex



Ref.	Código	Capacidad ml	€/u.
12124765	22124765	750	6,00

Espuma poliuretano ORBAFOAM

Quilosa



Ref.	Código	Descripción	Nombre	€/u.	Ref.	Código	Descripción	Nombre	€/u.
1100420	10026675	Amarillo 750 ml	PRO45 O2-M1	8,77	1100428	10026579	Amarillo 500 ml	V&P PRO-ENERGY O2-M1	11,94
1100421	10025046	Amarillo 750 ml	PRO45 O2-M1	8,98	1100429	10036223	Amarillo 750 ml	FIRE-STOP	14,54
1100426	10025048	Amarillo 750 ml	XTREM O2-M1	13,49	1100430	10003282	Gris hormigón 750 ml	FIRE-STOP	14,75
1100427	10026101	Amarillo 750 ml	V&P BAJA EXPANSIÓN O2-M1	8,99	1100431	10025032	Amarillo 500 ml	LIMPIADOR	8,36

Espuma NONFIRE



Espuma de poliuretano especial para protección pasiva contra el fuego. Clasificada EI/RF 240 y Bs1d0.



Ref.	Código	Descripción	Capacidad ml	€ / u.
2402956	50180	Espuma ignifuga	750 ml	23,44
2402957	50185	Espuma ignifuga	750 ml	26,49

Espuma poliuretano PENOSIL



Ref.	Código	Descripción	Nombre	€ / u.
2402958	A5952	Amarillo 750 ml	PU-46 [Cánula-Pistola] MULTIUSOS	8,15
2402959	A5953	Amarillo 750 ml	PU-47 [Pistola]	8,15
2402960	A5962	Rojo teja 750 ml	TEJAS PU-49 PISTOLA	9,99
2402961	A5961	Gris teja 750 ml	TEJAS PU-49 PISTOLA	9,99
2402962	A5959	Rojo teja 750 ml	TEJAS PU-49 CANULA	9,93

Ref.	Código	Descripción	Nombre	€ / u.
2402964	A5960	Verde 750 ml	FLEXIBLE PU-00	9,93
2402965	A5970	Transparente 500 ml	LIMPIADOR ESPUMA	10,17
2402966	A5951	Rosa 750 ml	PU-476 ignifuga (Cánula)	17,62
2402967		Amarillo 750 ml	PU-476 ignifuga (Pistola)	17,62

Espuma poliuretano ORBAFOAM



Espuma adhesiva de agarre inmediato

Ref.	Código	Descripción	€ / u.
2402968	10040759	750 ml [Cánula]	12,55
2402969	10040750	750 ml [Pistola]	13,60



Espuma poliuretano ORBAFOAM



Espuma adhesiva de PU profesional diseñado para cartón yeso y para la mayoría de los tipos de tableros

Ref.	Código	Descripción	€ / u.
2402970	10041627	Azul 830 ml	15,70
2402971	10041969	Amarillo 870 ml	11,97



Espuma poliuretano ORBAFOAM



Espuma poliuretano multiusos

Ref.	Código	Descripción	€/u.
2402972	10049174	Amarillo 670 ml	5,55
2402973	10048919	Amarillo 700 ml	5,75



Pistola para espuma de poliuretano



Ref.	Código	€/u.
1108500	26633	19,23



Pistola silicona



Ref.	Código	Descripción	Modelo	Peso kg.	€/u.
1108214	17922210	Pistola silicona varilla hexagonal	WT214	0.38	4,37

Ref.	Código	Descripción	Modelo	Peso kg.	€/u.
1108215	17922215	Pistola silicona profesional, muy resistente y de gran espesor en toda su estructura	WT215IH	0.66	11,07

Ref.	Código	Descripción	Modelo	Peso kg.	€/u.
1108230	17922230	Pistola para silicona estándar	WT230A	0.595	6,21

Ref.	Código	Descripción	Modelo	Peso kg.	€/u.
1108250	17922250	Pistola para silicona, inyección de selladores: Yeso, cemento, mortero y también cartucho. Dotación: Una boquilla y un empujador	WT250	0.505	10,21

Ref.	Código	Descripción	Modelo	Peso kg.	€/u.
1108251	17922254	Pistola para silicona, inyección de selladores: Yeso, cemento, mortero y también cartucho. Dotación: Una boquilla y un empujador	WT250XL	0.705	13,36



Pistola silicona



Pistola silicona Convoy Just. Doble sistema de empuje. Paro automático de flujo que evita la pérdida de silicona. Máxima potencia para cartucho de alta viscosidad

Ref.	Código	€/u.
8001903	7108SJ	20,99



Sellador-Adhesivo de poliuretano SINTEX PU-50



Sellador-Adhesivo de poliuretano de módulo medio-alto para el pegado y sellado elástico. Fuerte y elástico 2 en 1. Interior y exterior. Pintable. Excelente adhesión en cemento, ladrillo, cerámica, metales, madera, poliuretano, epoxi y algunos poliésteres. Sellado y pegado elástico en construcción e industria. Pegado de elementos de construcción (tejas, mamparas, rodapiés). Juntas de dilatación y estáticas. Sellado marco-obra y carpintería entre sí. Juntas en suelos transitables. Sellado y pegado elástico en industria (ventilación, aire acondicionado, automoción, containers, elementos metálicos).



Ref.	Código	Descripción	€/u.
1100440	10043605	Blanco 300 ml	4,57
1100441	10043606	Gris 300 ml	4,57
1100442	10043607	Marrón 300 ml	4,57
1100443	10043608	Negro 300 ml	4,57
2402974	10042336	Teja 300ml	4,57
2402975	10042338	Beige 300 ml	4,57

Sellador PU. Pattex SP101 original



Sella-Pega Profesional. Multimateriales. Alta adhesión. Todo tipo de situaciones.

Ref.	Código	Descripción	Color	Capacidad ml	€/u.
1512047	2026556	SP 101 BOLSA 600 ML - BLANCO	Blanco	600	23,51
21048017	2496061	SP 101 CART. 280 ML FUNGICIDA - BLANCO	Blanco	280	13,15
21048018	2496063	SP 101 CART. 280 ML - MARRÓN	Marrón	280	13,15
21048019	2496371	SP 101 CART. 280 ML - NEGRO	Negro	280	13,15
21048020	2496062	SP 101 CART. 280 ML - GRIS	Gris	280	13,15



Adhesivo de polímero MS INSTANT



Adhesivo de polímero MS para el pegado elástico. Agarre inmediato: 10 segundos. Ultra resistente: 300 Kg/10cm2. Excelente adhesión sobre la mayoría de los sustratos: ladrillo, tejas, hormigón, metales, plásticos, mármol, granito, poliestireno, policarbonato, vidrio, PVC, madera, DM, aluminio, cerámica, espejos. Elástico: absorbe vibraciones y movimientos de dilatación y contracción. Exento de sustancias peligrosas. Para la fijación instantánea donde se requiera un pegado resistente y flexible. Piezas metálicas y plásticas, paneles, chapas, espejos, planchas de aislamiento, elementos prefabricados, paneles de aglomerados.

Ref.	Código	Descripción	€/u.
1100445	10043307	Blanco 280 ml	7,05



Sellante adhesivo. POLYMER H



Sellante adhesivo de nueva generación en base a polímero híbrido modificado.

Ref.	Código	Descripción	Capacidad ml	€/u.
2402976	59914	Adhesivo híbrido	600 ml	10,65



Sellador de polímero. POLYMER PRO



Sellante adhesivo de nueva generación en base a polímero híbrido modificado.

Ref.	Código	Descripción	€/ u.
1108700	59903	POLYMER H75 Sellado y Pegado Blanco	6,92
1108701	59913	POLYMER H75 Sellado y Pegado Gris	6,92
1108702	59923	POLYMER H75 Sellado y Pegado Marrón	6,92
1108703	59933	POLYMER H75 Sellado y Pegado Negro	6,92
1108706	59953	POLYMER TRANSPARENTE Efecto Cristal	7,72
1108707	59973	POLYMER H200 ESTRUCTURAL	7,95



59903

59953

59973

Adhesivo polímero híbrido MS



Adhesivo polímero híbrido MS

Ref.	Código	Descripción	€/ u.
2402977	10045462	Transparente 280 ml	9,90
2402978	10041620	Blanco 280 ml	9,14
2402979	10041647	Negro 280 ml	9,14
2402980	10041645	Crema 280 ml	9,14
2402981	10041646	Marrón 280 ml	9,14
2402982	10041641	Gris 280 ml	9,14



Pasta reparadora rápida LITEPLAST



Pasta reparadora rápida y ligera, lista para el uso y de muy fácil aplicación. Rellena y repara rápidamente grietas, fisuras, hendiduras, agujeros, etc. en cualquier tipo de superficie (yeso, madera, estucado, muros, etc.). Uso interior o exterior. No merma ni se agrieta. Se puede pintar, barnizar y lijar. Acabado super blanco. Apta para interiores y exteriores.

Ref.	Código	Descripción	€/ u.
1100450	10043812	Blanco 250 ml	5,20
1100451	10043813	Blanco 750 ml	10,45



Pasta montaje



Ref.	Código	Descripción	Capacidad	€/ u.
2402983	51414	Pasta antigripante y de montaje de base cobre. Excelente poder anticorrosivo (MIL-A-907-D).	1 kg	100,35
2402984	52194	Pasta antigripante de base cobre. Excelente comportamiento a la corrosión, gripaje y bloqueo en presencia de agua y vapor.	1 kg	83,11
2402985	52204	Pasta de montaje multifuncional con MoS2. Lubricante apropiado para el montaje y rodaje de componentes metálicos.	1 kg	112,09
2402986	52214	Pasta de Zinc para conexiones roscadas, en particular con metales disimilares. Muy buena protección galvánica contra la corrosión.	2 kg	74,80
2402987	52422	Pasta antigripante de base cobre. Excelente comportamiento a la corrosión, gripaje y bloqueo en presencia de agua y vapor.	500 ml	27,02



Chem poliéster PST



Anclaje químico a base de resina poliéster. Idóneo para materiales huecos y cargas medias.

Ref.	Código	Capacidad ml	€ / u.
1100080	25400003	300	14,03
1100081	25400004	410	14,50



Chem poliéster PSF



Anclaje químico a base de resina poliéster SIN ESTIRENO. Idóneo para materiales huecos y cargas medias.

Ref.	Código	Capacidad ml	€ / u.
1100085	25400005	300	29,82
1100086	25400010	410	34,96



Chem epoxi acrilato EAC



Anclaje químico a base de resina epoxi acrilato. Idóneo para cargas medias y altas. Incluso en ambientes húmedos.

Ref.	Código	Capacidad ml	€ / u.
1100090	25400199	300	15,93
1100091	25400201	410	17,86



Chem epoxi ESF



Anclaje químico a base de resina epoxi SIN ESTIRENO. Idóneo para cargas medias y altas. Incluso en ambientes húmedos.

Ref.	Código	Capacidad ml	€ / u.
1100093	25400006	300	36,10
1100094	25400008	410	42,00



Chem pure epoxi PEX



Anclaje químico bicomponente a base de resina epoxi. Muy adecuado para uniones estructurales de hormigón con hormigón a través de varillas corrugadas. Idóneo sobre taladros realizados con broca de diamante. Para fijación de varillas corrugadas y roscadas.

Ref.	Código	Capacidad ml	€ / u.
1100455	25400287	400	43,85



Chem piedra fachadas PFV



Anclaje químico a base de resina poliéster. Para fijaciones especiales en fachadas ventiladas y piedra. Mezcla de color piedra.



Ref.	Código	Capacidad ml	€ / u.
1100456	25400320	410	17,56

Chem TQD



Anclaje químico a base de resina vinilester SIN ESTIRENO. Formato BRICO. Multimaterial. Incluye 2 mixers



Ref.	Código	Capacidad ml	€ / u.
1100457	25400230	300	18,52

Chem Artic



Anclaje químico a base de resina epoxi SIN ESTIRENO. Idóneo para temperaturas extremadamente BAJAS



Ref.	Código	Capacidad ml	€ / u.
1100458	25400340	300	21,91

Anclaje químico



Anclaje químico para grandes cargas en elementos macizos Poliéster. Homologado ETE Opción 7 (410 ml. 12 uds.) Producto homologado EOTA. Producto homologado CE Recomendado para usar en: hormigón, ladrillo macizo, ladrillo hueco, termoarcilla... entre otros. Fácil instalación.



Ref.	Código	Capacidad ml	€ / u.
8005283	410SIPOLY	410	9,22

Cinta GAFFER 4688



Cinta extrafuerte. Tejido plastificado.
Cinta de reparación para todo tipo de necesidades.



Ref.	Código	Anchura mm	Color	Longitud m	€ / u.
1109442	04688-00029-00	50	Negro	50	21,13
1109443	04688-00031-00	50	Plata	50	21,13
1109444	04688-00023-00	50	Azul	50	19,00
1109445	04688-00020-00	50	Amarillo	50	19,00
1109446	04688-00021-00	50	Rojo	50	19,00
1109447	04688-00022-00	50	Verde	50	19,00
1109448	04688-00042-00	50	Negro	25	11,62

Ref.	Código	Anchura mm	Color	Longitud m	€ / u.
1109449	04688-00043-00	50	Blanco	25	11,62
1109450	04688-00047-00	50	Plata	25	11,62
1109451	04688-00045-00	50	Amarillo	25	11,62
1109452	04688-00046-00	50	Rojo	25	11,62
1109453	04688-00044-00	50	Azul	25	11,62
1109454	04688-00048-00	50	Verde	25	11,62
1109455	04688-00049-00	50	Marrón	25	11,62

Band Premium. 4661



Cinta de tejido recubierto. Altas prestaciones.

Ref.	Código	Anchura mm	Color	Longitud m	€ / u.
1100011	04661-00011-00	50	Negro	50	60,86
1100022	04661-00022-00	50	Blanco	50	60,86
1100030	04661-00030-00	50	Azul	50	60,86
1100036	04661-00036-00	50	Amarillo	50	60,86
1100043	04661-00043-00	50	Rojo	50	60,86
1100059	04661-00059-00	50	Gris	50	60,86



Burlete EPDM 60492



Cinta autoadhesiva de espuma de EPDM, resistente a la temperatura y el envejecimiento.

Ref.	Código	Anchura mm	Color	Longitud m	€ / u.
1160496	60492-00006-00	15	Negro	10	11,19
1160493	60492-00003-00	19	Negro	10	14,18
1160495	60492-00015-00	38	Negro	10	28,35



Cinta americana 4613



Cinta americana multiusos.

Ref.	Código	Anchura mm	Color	Longitud m	€ / u.
1100137	04613-00037-01	48	Plata	50	11,52



Cinta americana 4610



Ref.	Código	Anchura mm	Longitud m	Color	€ / u.
8001546	04610-00000-00	48	50	Gris	6,72
8001547	04610-00004-00	48	50	Negro	6,72



3M™ Cinta americana 1900



La cinta americana 1900 de 3M™ es una cinta básica perfecta para tener a mano en cualquier caja de herramientas; es apta para aplicaciones generales como sellado ligero, empaquetado, señalización y reparaciones temporales en aplicaciones no críticas. Su adhesivo de caucho sintético se adhiere al contacto con metal liso, vidrio, plástico y hormigón sellado, entre otros materiales.

Ref.	Código	Ancho (mm)	Longitud (m)	Color	€ / u.
8002944	7000071798	50	50	Negro	6,07



Cinta americana Scotch®



Ref.	Código	Espesor (mm)	Anchura (mm)	Longitud (m)	€ / u.
8003082	7000076790	0,15	50	46	9,54



Cinta americana



Cinta americana TOP

Ref.	Código	Color	Longitud m	Anchura mm	€ / u.
21104004	CTN1050	Negro	10	50	7,43
21104005	CTN2550	Negro	25	50	13,42
21104006	CTN5050	Negro	50	50	24,42
21104007	CTP1050	Plata	10	50	7,43
21104008	CTP2550	Plata	25	50	13,42
21104009	CTP5050	Plata	50	50	24,42



Cinta americana multiusos



Cinta americana multiusos

Ref.	Código	Descripción	Color	€ / u.
21048014	2502184	PATTEX ADVENTURE CINTA GRIS 20+10M	Gris	12,68
21048015	2502183	PATTEX ADVENTURE CINTA NEGRA 20+10M	Negro	12,68



Cinta Scotch® para reparación de cubierta del cable en entornos agresivos como cable de minería



Ref.	Código	Espesor (mm)	Anchura mm	Longitud (m)	€/ u.
8003032	7000006227	1,52	50	2	37,51



Cinta aislante 53948



Cinta para el aislamiento, agavillado y marcado de cables eléctricos, extremadamente flexible. Cumple las normas IEC IMQ y SEMKO.

Ref.	Código	Anchura mm	Color	Longitud m	€/ u.
1109200	53988-00001-00	19	Negro	20	1,53
1109201	53988-00061-00	19	Blanco	20	1,53
1109202	53988-00031-00	19	Azul	20	1,53
1109203	53988-00016-00	19	Rojo	20	1,53
1109204	53988-00091-00	19	Verde	20	1,53
1109206	53988-00106-00	19	Gris	20	1,53
1109208	53988-00046-00	19	Verde/Amarillo	20	1,53
1109209	53988-00076-00	25	Negro	25	1,53
1109210	53988-00138-00	25	Blanco	25	2,51
1109211	53988-00141-00	50	Negro	25	2,51
1109212	53988-00004-00	50	Blanco	25	5,05



Cinta aislante de altas prestaciones 3M™ Scotch®



Ref.	Código	Espesor (mm)	Anchura mm	Longitud m	€/ u.
8003034	7000058432	0,18	19	6	3,61
8003035	7000042541	0,18	19	20	8,49
8003036	7000057831	0,18	19	33	13,49
8003037	7000058272	0,18	19	33	10,08

Ref.	Código	Espesor (mm)	Anchura mm	Longitud m	€/ u.
8003038	7000043003	0,18	25	33	18,88
8003039	7000031512	0,18	38	33	20,69
8003048	7000058437	0,18	19	20	7,90

Cinta aislante de Uso General 3M™ Temflex 1500 / 1800



Ref.	Código	Espesor (mm)	Anchura mm	Longitud m	€ / u.
8003052	7000062301	0,15	19	20	2,82
8003055	7000062299	0,15	19	20	2,82
8003063	7000076787	0,2	50	33	12,63



Cinta aislante Básica 3M™ Temflex 1300



Ref.	Código	Espesor (mm)	Anchura mm	Longitud m	€ / u.
8003072	7000062625	0,13	19	20	2,28



Cinta eléctrica autosoldable de uso eléctrico



Ref.	Código	Espesor (mm)	Anchura mm	Longitud m	€ / u.
8003023	7000034804	0,76	19	9,15	10,39
8003030	7000034806	0,76	19	4,5	49,24
8003020	7000007284	0,76	19	4,5	15,09
8003021	7000007286	0,76	19	9,15	16,34
8003024	7000034850	0,76	25	9,15	19,80

Ref.	Código	Espesor (mm)	Anchura mm	Longitud m	€ / u.
8003025	7000138529	0,76	38	9,15	30,29
8003026	7000006225	0,30	25	9,14	46,26
8003027	7000006089	3,18	38	1,5	17,82
8003028	7000007285	0,51	19	9,15	7,75
8003029	7000006085	0,76	19	9,15	25,65

Cinta Eléctrica Scotch® para APantallamiento y tierra



Ref.	Código	Anchura mm	Longitud m	€ / u.
8003073	7000031348	25	5	15,84



Cinta Eléctrica Scotch® para APantallamiento y tierra



Ref.	Código	Anchura mm	Longitud m	€/ u.
8003074	7100011690	13	5	57,49



Cinta reflectante



Cinta reflectante



Ref.	Código	Anchura mm	Longitud m	Color	€/ u.
21104018	CRR3350	33	50	Roja	33,06
21104019	CRA3350	33	50	Amarilla	33,06
21104020	CRB3350	33	50	Blanca	33,06

Ref.	Código	Anchura mm	Longitud m	Color	€/ u.
21104021	CRAN3350	33	50	Amarilla/Nera	34,87
21104022	CRBR3350	33	50	Roja/Blanca	34,87

Cinta reflectante certificada 104-R



Cinta reflectante certificada

Ref.	Código	Anchura mm	Longitud m	Color	€/ u.
21104023	CRR2550H	25	50	Roja	99,74
21104024	CRA2550H	25	50	Amarilla	99,74
21104025	CRB2550H	25	50	Blanca	99,74



Cinta reflectante segmentada certificada 104-R



Cinta reflectante certificada segmentada

Ref.	Código	Anchura mm	Longitud m	Color	€/ u.
21104026	CRR2550S	25	50	Roja	111,32
21104027	CRA2550S	25	50	Amarilla	111,32
21104028	CRB2550S	25	50	Blanca	111,32



3M™ Cinta de aluminio 425, ABS5604



Cinta de aluminio para diversas tareas como enmascarado, sellado, costuras, protección y raspado químico. Nuestra cinta es perfecta para enmascarado, sellado, costuras, protección y raspado químico, entre muchas otras tareas. Conocida ampliamente como el mejor producto de soporte de aluminio de uso general disponible, nuestra cinta es extraordinariamente suave y cuenta con un adhesivo acrílico sintético transparente especial.



Ref.	Código	Anchura mm	Longitud m	€/ u.
8002939	7100053596	50	55	90,74

3M™ Cinta de aluminio 1436F



Cinta de aluminio de uso general (0,075 mm de espesor). Incluye un potente adhesivo de caucho, un liner de fácil separación y un soporte de aluminio blando, lo que ofrece buena adaptabilidad. Cinta para aplicaciones en interior y en exterior. Se une a distintas superficies, incluidas maderas, metales y plásticos y satisface las especificaciones de baja inflamabilidad de acuerdo con DIN4102B1.

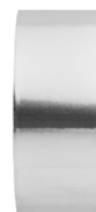

Ref.	Código	Anchura mm	Longitud m	€/ u.
8002940	7000062000	50	100	20,81

Cinta de tela Impregnada Scotch®



Ref.	Código	Espesor (mm)	Anchura mm	Longitud m	€/ u.
8003079	7000062745	0,3	50	50	66,24



Sellador eléctrico Scotch®



Ref.	Código	Espesor (mm)	Anchura mm	Longitud m	€/ u.
8003089	7000026559	2,1	100	3	59,32
8003090	7000005986	2	50	3	28,80
8003091	7000005872	1,14	64	3	33,40
8003092	7000043008	3,2	96	3	49,83



Cinta 3M™ Scotchflex™ para sujeción y organización de cables



Ref.	Código	Anchura mm	Longitud m	€/ u.
8003093	7000033355	20	10	25,59



Cinta bituminosa



Es una membrana autoadhesiva flexible, de material bituminoso impermeable, reforzado con una cobertura de aluminio. Especial para sellar, reparar fisuras y grietas evitando la entrada de agua y garantizando la estanqueidad en las juntas de diferentes superficies. Indicado para uniones entre suelo, muros en terrazas y azoteas. Para reparar canalones, tuberías, tejados, encuentros de chimenea. Resiste al agua y a los rayos UV. Alta elasticidad, no se despega fácilmente. Se adhiere de forma inmediata.



Ref.	Código	Color	Anchura cm	Longitud m	€ / u.
1100460	10003756	Terracota	10	10	17,80
1100461	10003753	Aluminio	10	10	17,80
1100462	10024903	Negro	10	10	17,80

Ref.	Código	Color	Anchura cm	Longitud m	€ / u.
1100463	10024945	Terracota	30	10	52,45
1100464	10024907	Negro	30	10	52,45
1100465	10024904	Aluminio	30	10	52,45

Cinta KREPP 4323 y cinta + plástico EASY COVER 4368



Cinta para todo tipo de trabajos de pintura. Adhesión fuerte y segura. Se retira limpiamente y sin dejar residuos.

Ref.	Código	Anchura mm	Longitud m	€ / u.
1109600	04323-00006-00	19	50	1,58
1109601	04323-00008-00	25	50	2,04
1109602	04323-00009-00	30	50	2,46
1109603	04323-00011-00	38	50	3,10
1109604	04323-00013-00	50	50	4,06



3M™ Cinta de enmascarado 101E



La cinta de enmascarado 101E es una cinta de papel crepé suave y multiusos. Esta cinta de color beige, con adhesivo de caucho y un grosor de 0,12 mm está diseñada para uso general (sujeción temporal, enmascarado de pintura ...)

Ref.	Código	Anchura (mm)	Longitud (m)	€ / u.
8002946	7100135739	18	50	1,43
8002947	7100135737	24	50	1,90
8002948	7100135748	30	50	2,38
8002949	7100135761	36	50	2,86
8002950	7100135720	48	50	3,81



Cinta de embalaje



4024 Poliolefina hi-tack. Alta seguridad en su embalaje, sin restos de adhesivo.

Ref.	Código	Color	Dimensiones	€ / u.
715226	04024-00235-04	Marrón	66m x 50mm	2,95
715227	04024-00209-04	Blanco	66m x 50mm	3,10



Cinta de embalaje



4089 PP Caucho Natural. Alta seguridad en su embalaje, sin restos de adhesivo.

Ref.	Código	Color	Dimensiones	€ / u.
715230	04089-00001-06	Transparente	66m x 50mm	2,48
715231	04089-00021-06	Blanco	66m x 50mm	2,48
715232	04089-00006-06	Marrón	66m x 50mm	2,48
715233	04089-00042-06	Transparente	132m x 50mm	4,95
715234	04089-00231-06	Blanco	132m x 50mm	4,95
715235	04089-00106-06	Marrón	132m x 50mm	4,95



Cinta de embalaje



tesa 4591 Fleje Filamentos Bidireccional

Ref.	Código	Color	Dimensiones	€/u.
715240	04591-00001-00	Transparente	50m x 19mm	4,46
715241	04591-00002-00	Transparente	50m x 25mm	5,87
715242	04591-00000-00	Transparente	50m x 50mm	11,69



3M™™ Scotch® Cinta de embalaje 309, PP BAJO RUIDO



Línea completa de sistemas de cerrado de cajas, así como cintas de alta resistencia líderes del mercado, diseñadas para satisfacer cualquier necesidad de refuerzo, unión o sujeción.

Ref.	Código	Color	Dimensiones mm	€/u.
8002941	7000095502	Marrón	66m x 50mm	2,60
8002942	7000095501	Transparente	66m x 50mm	2,60



3M™™ Dispensador de mano para cinta de embalaje (hasta 50mm) H180



Línea completa de sistemas de cerrado de cajas, así como cintas de alta resistencia líderes del mercado, diseñadas para satisfacer cualquier necesidad de refuerzo, unión o sujeción.

Ref.	Código	€/u.
8002943	7000146617	14,50



Cinta antideslizante



Cinta antideslizante



Ref.	Código	Anchura mm	Longitud m	Color	€/u.
21104010	CAN0550	50	5	Negro	9,87
21104011	CAN1550	50	15	Negro	26,51
21104012	CAT0550	50	5	Transparente	10,23
21104013	CAT1550	50	15	Transparente	27,69

Ref.	Código	Anchura mm	Longitud m	Color	€/u.
21104014	CANA1050	50	10	Amarilla/Negra	19,61
21104015	CARB1050	50	10	Roja/Blanca	19,61
21104016	CALU0550	50	5	Luminiscente	25,49
21104017	CARE0550	50	5	Reflectante	20,85

Cinta X-treme 4600



Cinta autosoldable de silicona.

Ref.	Código	Anchura mm	Longitud m	Color	€ / u.
1113800	04600-00000-00	25	3	Transparente	14,41
1113801	04600-00001-00	25	3	Negra	14,41



Cinta adhesiva de señalización 60760



Cinta de PVC plastificado con adhesivo de caucho. Útiles para el marcaje de aviso tanto para elementos fijos como móviles que puedan ser peligrosos o potenciales causantes de daños ó lesiones.



Ref.	Código	Anchura mm	Longitud m	Color	€ / u.
1109700	60760-00088-15	50	33	Rojo/Blanco	10,26
1109701	60760-00087-15	50	33	Amarillo/Negro	10,26
1109702	60760-00094-15	50	33	Blanco	10,26
1109703	60760-00095-15	50	33	Amarillo	10,26

Ref.	Código	Anchura mm	Longitud m	Color	€ / u.
1109704	60760-00096-15	50	33	Rojo	10,26
1109705	60760-00097-15	50	33	Verde	10,26
1109706	60760-00098-15	50	33	Azul	10,26

Cinta selladora multiusos autofundente



Al aplicarse alrededor de una superficie, la cinta se funde sobre si misma e instantáneamente sella y protege la zona frente a fugas y filtraciones de humedad.

Ref.	Código	Descripción	€ / u.
21048016	2198905	Blister de 3m.	12,43



Cinta de espuma acrílica. Tesafix 4957



Cinta de doble cara con soporte de espuma de PE y adhesivo acrílico. Blanca.

Ref.	Código	Anchura mm	Longitud m	€ / u.
1100008	04957-00008-00	19	25	11,04



Cinta para moquetas removible Premium tejido. Tesafix 4964



Cinta doble cara con soporte textil y adhesivo de caucho. Tejido blanco.

Ref.	Código	Anchura mm	Longitud m	€/ u.
1100075	04964-00075-00	19	50	29,13



Tesafix 4965 - PET - Acrílico Alta Adhesión



Cinta de doble cara adhesiva con alta resistencia a la temperatura y exterior

Ref.	Código	Anchura mm	Longitud m	Color	€/ u.
1100006	04965-00008-00	19	50	Transparente	25,20



3M™ VHB™ Cinta de espuma acrílica 4910F



Idónea para materiales transparentes o para productos donde se necesite una unión transparente

Ref.	Código	Anchura mm	Longitud (m)	€/ u.
8002914	7100123355	11	19	41,24



3M™ VHB™ Cinta de espuma acrílica GPH-110GF



Cinta adhesiva acrílica multiusos gris de 1,1 mm de espesor con un núcleo de espuma adaptable, que también resiste altas temperaturas

Ref.	Código	Anchura mm	Longitud (m)	€/ u.
8002916	7100099836	12	33	27,32
8002917	7100099833	19	33	39,69
8002918	7100099834	25	33	52,22



Cinta acrílica ACX PLUS alta adhesión. Tesafix 706X



Cinta de doble cara especial para materiales plásticos. Negra.

Ref.	Código	Espesor mm	Anchura mm	Longitud m	€/ u.
1107063	07063-00011-22	0,8	19	25	56,80
1107065	07065-00011-22	1,2	19	25	69,41



3M™ Cinta doble cara 9088-200, Blister



La cinta adhesiva de doble cara de altas prestaciones 3M™ 9088-200 es la cinta de uso general más esperada del mercado. Esta cinta duradera presenta una elevada resistencia a pelado, cizalladura, rayos ultravioleta, productos químicos y altas temperaturas. Su agarre duradero la convierte en una excelente elección para expositores de publicidad, cajas de luz, señales, fabricación de metal, decoración del hogar, encuadernación y embalaje, entre otras aplicaciones.



Ref.	Código	Anchura (mm)	Longitud (m)	€ / u.
8002960	7100139264	19	50	15,10

3M™ Hook & Loop™ Sistemas de unión desmontable SJ3520



Alternativas de cierre a cremalleras, tornillos, broches, enganches, pasadores, etc. Ofrecen mayor flexibilidad de diseño, ensamblaje de productos más rápido, superficies exteriores más suaves y limpias y mejor rendimiento del producto en muchas aplicaciones.



Ref.	Código	Anchura (mm)	Longitud (m)	Color	€ / u.
8002961	7100123266	1.25	25	Negro	13,70

Cinta 3M™ Scotchrap™ anticorrosión tuberías



Ref.	Código	Espesor (mm)	Anchura (mm)	Longitud (mm)	€ / u.
8003083	7000005811	0,25	25	30,4	19,73
8003084	7000005812	0,25	50	30,4	36,86
8003085	7000057485	0,25	100	30,4	69,54
8003086	7000057486	0,25	150	30,4	111,10



3M™ Cinta de vinilo 471



Diseñada para codificación, protección frente a abrasiones, decoración, sellado, aplicación de parches, uniones y aplicaciones de uso general. Disponible en varios colores.

Ref.	Código	Ancho (mm)	Longitud (m)	Color	€ / u.
8002919	7000028852	50	33	Amarillo	48,75
8002927	7000028851	50	33	Azul	48,75
8002920	7000028853	50	33	Blanco	48,75
8002921	7000028854	50	33	Naranja	48,75
8002923	7000048401	50	33	Negro	48,75
8002924	7000028850	50	33	Rojo	48,75
8002925	7000048403	50	33	Transparente	48,75
8002926	7000028855	50	33	Verde	48,75
21003026	7100044646	12	33	Amarillo	13,41
21003027	7000047467	19	33	Amarillo	18,28
21003028	7000047468	25	33	Amarillo	24,37
21003029	7000047469	38	33	Amarillo	36,57
21003030	7000047470	75	33	Amarillo	73,12
21003031	7000047471	100	33	Amarillo	97,49
21003032	7100055258	3	33	Azul	5,00
21003033	7100055835	6	33	Azul	9,99
21003034	7000047461	12	33	Azul	12,18
21003035	7000047462	19	33	Azul	18,28
21003036	7000047463	25	33	Azul	24,37
21003037	7000047473	19	33	Blanco	18,28
21003038	7000047474	25	33	Blanco	24,37
21003039	7000047476	100	33	Blanco	97,49
21003040	7000047457	19	33	Negro	18,28
21003041	7000047458	25	33	Negro	24,37
21003042	7000047460	100	33	Negro	97,49
21003043	7000047451	12	33	Rojo	12,18
21003044	7000047452	19	33	Rojo	18,28
21003045	7000047453	25	33	Rojo	24,37
21003046	7000047454	38	33	Rojo	36,57
21003047	7000047455	100	33	Rojo	97,49
21003048	7000047449	38	33	Transparente	36,57
21003049	7000047477	12	33	Verde	12,18
21003050	7000047478	19	33	Verde	18,28
21003051	7000047479	25	33	Verde	24,37
21003052	7000028855	50	33	Verde	48,75



3M™ Dual Lock™ Sistemas de unión desmontable SJ3550



Adhiere bien a diferentes materiales de energía superficial media y alta, incluidas algunas superficies pintadas, de plástico, metálicas y de vidrio.

Ref.	Código	Espesor (mm)	Longitud (m)	Color	€ / u.
8002963	7100123340	2.5	25	Transparente	41,42



3M™ Cinta premium de vinilo con franjas de seguridad 5702



Diseñada para codificación, protección frente a abrasiones, decoración, sellado, aplicación de parches, uniones y aplicaciones de uso general. Disponible en varios colores.

Ref.	Código	Ancho (mm)	Longitud (m)	€ / u.
8002928	7000017005	50	33	57,72



3M™ Cinta de vinilo con franjas de seguridad



La cinta para aviso de peligros 766 de 3M™ es una cinta de vinilo con franjas negras y amarillas. Nuestra cinta se utiliza para marcar áreas peligrosas, equipos salientes o para evitar accidentes en fábricas, almacenes y hospitales



Ref.	Código	Color	Anchura mm	Anchura mm	€ / u.
8002937	7100015263	Amarillo/Negro	50	50	9,36

3M™ Cinta de Vinilo 764



Hay numerosas formas de usar la cinta de vinilo de uso general 764 de 3M™. Nuestra cinta de vinilo es perfecta para cualquier aplicación no crítica. Pruebe a usar esta cinta para codificar por colores, agrupar, realizar marcados de seguridad, marcado temporal de piezas o máquinas y otras muchas aplicaciones. Puede utilizarse incluso para proteger piezas, equipos y productos frente a la abrasión. No es corrosiva, es flexible, resistente a la abrasión, adaptable, resistente al desgaste, fácil de aplicar, versátil y resistente a la humedad.



Ref.	Código	Ancho (mm)	Longitud (m)	Color	€ / u.
21003053	7000144706	50	33	Amarillo	7,80
21003054	7000048921	50	33	Azul	7,80
21003055	7000144707	50	33	Blanco	7,80
21003056	7000048918	50	33	Gris	7,80
21003057	7000048923	50	33	Naranja	7,80
21003058	7000048917	50	33	Negro	7,80
21003059	7000048924	50	33	Roja	7,80
21003060	7000144708	50	33	Verde	7,80

3M™ Cinta premium de vinilo con franjas de seguridad 5702



Diseñada para codificación, protección frente a abrasiones, decoración, sellado, aplicación de parches, uniones y aplicaciones de uso general. Disponible en varios colores.



Ref.	Código	Ancho (mm)	Longitud (m)	€ / u.
21003067	7000048386	75	33	87,74
21003068	7000048387	100	33	117,00

3M™ Cinta de Vinilo con Franjas de Seguridad 766



3M™ Cinta de Vinilo con Franjas de Seguridad 767, Rojo/Blanco, 50 mm x 33 m



Ref.	Código	Ancho (mm)	Longitud (m)	Color	€ / u.
21003069	7100015266	50	33	Rojo/Blanco	9,36

Profesional super penetrante aflojatodo



Penetra y actúa rápidamente liberando y protegiendo piezas bloqueadas. Test de tensión en superficie (ASTM D-1331)=19,58 - 22,46 dinas /cm. No contiene silicona. Compatible con todos los metales. Rango de temperaturas: -30° a 150° C. Aplicaciones: Tuercas, tornillos, piezas atascadas. Tuberías. Instalaciones. Cerraduras. Cadenas. Juntas. Bisagras. Herramientas.



Ref.	Código	Capacidad ml	€/ u.
1510601	34081	250	8,88

Aflojatodo enfriador. ROST OFF



Limpia de forma rápida y eficaz aceite, grasa y mugre. Su fórmula solvente permite una rápida evaporación y una fácil limpieza. Actúa rápidamente, no deja residuos y su fórmula es ideal para la limpieza de motores, maquinaria, engranajes y cadenas Pulverizador doble acción.



Ref.	Código	Capacidad	€/ u.
1100580	1031682	250 ml	8,24
1100581	1031907	5 l	61,98

Aflojatodo enfriador. ROST FLASH



Acción rápida: cuando se pulveriza dentro de uniones de tornillos/tuercas oxidados, el óxido se enfría [-40°C] y se rompe, dejando pequeñas fisuras. Cuando los líquidos activos penetran dentro de estas pequeñas fisuras, las partes bloqueadas se separan fácilmente. Afloja toda clase de piezas rosca-das, bisagras y piezas deslizantes. Libre de siliconas y ácidos.



Ref.	Código	Capacidad ml	€/ u.
1105800	1030166	500	10,90

Aceite lubricante



36713: Lubricante antihumedad, anticorrosión y desbloqueante.
36723: Lubricante especial para soltar piezas agarradas.

Ref.	Código	Capacidad ml	€/ u.
1510707	36713	500	10,14
1510708	36723	500	10,14



Lubricante multiuso antihumedad. 5-56



Lubricante sintético multiuso. Para lubricar y proteger cualquier cosa que se deslice, gire, ruede o chirrie. Dura hasta 4 veces más que los lubricantes tradicionales. oporta temperaturas extremas. No se adhiere el polvo ni la suciedad. Resiste al agua dulce y salada.

Ref.	Código	Capacidad	€ / u.
1111496	1032225	100 ml	3,43
1111497	1032232	250 ml	6,02
21030006	1032242	250 ml Con difusor Claverstraw	6,59
1111498	1032237	500 ml	9,07
21030007	1032249	500 ml Con difusor Claverstraw	9,80
1111502	1031919	5 L	40,77
1111499	1032057	5 L + pulv	40,77
1111503	1031921	20 L	163,00



Lubricante sintético QUILUBE aerosol



Lubricante sintético multiuso con PTFE. Para lubricar y proteger cualquier cosa que se deslice, gire, ruede o chirrie. Dura hasta 4 veces más que los lubricantes tradicionales. oporta temperaturas extremas. No se adhiere el polvo ni la suciedad. Resiste al agua dulce y salada.

Ref.	Código	Capacidad ml	€ / u.
1100470	10043862	200	6,34
1100471	10043863	400	8,76



Lubricante sintético QUILUBE tubo



Lubricante sintético multiusos con PTFE, resistente a la suciedad y al agua salada.

Ref.	Código	Capacidad ml	€ / u.
2402988	10043861	100	7,17



WD-40 Specialist aflojatodo Acción Rápida



Limpia de forma rápida y eficaz aceite, grasa y mugre. Su fórmula solvente permite una rápida evaporación y una fácil limpieza. Actúa rápidamente, no deja residuos y su fórmula es ideal para la limpieza de motores, maquinaria, engranajes y cadenas Pulverizador doble acción.

Ref.	Código	Capacidad ml	€ / u.
20001020	34392/NBA	500	11,56



WD-40 Multiusos Doble Acción



Gracias al cabezal de doble posición puede aplicarlo en forma precisa o amplia con tan solo un "clic". Elimina chirridos, desplaza la humedad, penetra, limpia, y desbloquea, lubrica y protege contra la corrosión y libera mecanismos oxidados. Ideal para cerraduras o mecanismos atascados por el óxido o por el frío. Lubrica y limpia herramientas y armas. Elimina cualquier tipo de cera, alquitrán, grasa o adhesivos. Evita cortocircuitos y limpia cuadros eléctricos. Pulverizador doble acción.

Ref.	Código	Capacidad ml	€ / u.
1113079	34034	500	10,49



Bidón 5 Litros + Pulverizador



Elimina chirridos, desplaza la humedad, penetra, limpia, y desbloquea, lubrica y protege contra la corrosión y libera mecanismos oxidados. Ideal para todo tipo de mantenimiento industrial y profesional. Puede aplicarse por inmersión, pulverización o con brocha. Regalo de un pulverizador.

Ref.	Código	Capacidad L	€ / u.
1113080	44506E	5	60,07



WD-40 Multiusos



Elimina chirridos, desplaza la humedad, penetra, limpia, y desbloquea, lubrica y protege contra la corrosión y libera mecanismos oxidados. Ideal para cerraduras o mecanismos atascados por el óxido o por el frío. Lubrica y limpia herramientas y armas. Elimina cualquier tipo de cera, alquitrán, grasa o adhesivos. Evita cortocircuitos y limpia cuadros eléctricos.

Ref.	Código	Capacidad ml	€ / u.
1113075	34002	200	5,91
1113077	34004	400	9,88



WD-40 Multiusos Flexible



Gracias a su cánula Flexible llega a sitios de difícil acceso, ahorrando tiempo y producto. WD-40 es un producto con 5 funciones y miles de usos: Lubrica piezas en movimiento tales como bisagras, rodamientos, cadenas y engranajes. Protege contra el óxido y la corrosión. Penetra y libera piezas atascadas y oxidadas como tuercas, candados y pistones. Abrillanta cromados y cualquier superficie metálica, eliminando también adhesivos y restos de pintura. Además, es un excelente desplazador de la humedad, pudiéndose utilizar en cuadros eléctricos, bujías y cualquier material eléctrico.

Ref.	Código	Capacidad ml	€ / u.
20001007	34688	400	11,56



Profesional lubricante de cerraduras



Limpieza y mantenimiento de cerraduras de interior, exterior, candados convencionales o antirrobo y todo tipo de cerrojos en general. Gran poder de penetración, ultra fluido. Protege del desgaste y la corrosión.

Ref.	Código	Capacidad ml	€ / u.
1510606	34462	100	4,59



Lubricante dieléctrico. 2-26



Mantenimiento y protección de equipos eléctricos y electrónicos. Su alto poder hidrófugo permite eliminar rápidamente el agua y la humedad de cualquier equipo. Antihumedad. Anticorrosivos.

Ref.	Código	Capacidad	€ / u.
1105300	1031622	250 ml	11,49
1105301	1030563	500 ml	20,06
1105302	1030011	5 L	115,34
1105303	1030012	20 L	448,70



Limpiador de contactos



Limpia y desengrasa eficazmente todo tipo de contactos.

Ref.	Código	Capacidad ml	€ / u.
1137213	37213	500	10,14



WD-40 Specialist limpiador de contactos



NO DEJA RESIDUOS. Limpia eficazmente todos los equipos eléctricos y electrónicos. Utilizar en equipos apagados. Limpia los contactos y conexiones de cajas y disyuntores eléctricos. Limpia eficazmente placas y circuitos electrónicos impresos. NSF K2. Pulverizador doble acción.

Ref.	Código	Capacidad ml	€ / u.
1113081	34368/NBA	400	11,56



Lubricante seco, blanquecino, con contenido en PTFE - DRY LUBE



Lubricante seco con PTFE de color blanco. Lubricante y con propiedades desmoldeantes. Mas efectivo con velocidades y cargas bajas. Registro NSF

Ref.	Código	Capacidad ml	€ / u.
21030023	1031561	500	22,75



Limpiador de contactos. FPS CONTACT CLEANER



Limpiador de contactos. Profesional. Residuo 0.NSF certificado alimentación - K2. Desarrollado para usar como limpiador de equipos eléctricos o electrónicos en áreas de procesado y no procesado de alimentos.

Ref.	Código	Capacidad ml	€ / u.
1100475	1030245	500	23,20



Profesional limpiador de contactos



Residual "0". Limpia y elimina la suciedad de todos los equipos eléctricos y electrónicos, circuitos impresos, conectores eléctricos y electrónicos, mecanismos de relojería, instrumentos de precisión, etc. Actúa y seca rápidamente sin dejar residuos. Es dieléctrico, soluble en agua e incoloro. Compatible con todo tipo de plásticos, metales y gomas. Temperatura de utilización de 5° a 30° C.

Ref.	Código	Capacidad ml	€/ u.
1510603	34091	250	8,88



Profesional lubricante para cadenas



Gracias a su fórmula sintética de alto rendimiento, aplica una capa protectora, duradera y resistente que ayuda a proporcionar una efectiva acción lubricante en condiciones donde existen altos niveles de fricción. Protege los mecanismos contra el óxido y la corrosión y reduce el desgaste de los componentes y la necesidad de reemplazarlos. Ideal para cadenas, cables y engranajes. Contiene PTFE.

Ref.	Código	Capacidad ml	€/ u.
1510604	34602	250	8,88



Lubricante MOTOSIERRAS



Especial para cadenas de motosierras. Larga duración

Ref.	Código	Capacidad	€/ u.
2402989	55944	1 L	5,04



Lubricante con PTFE



SUPERLUBE R.P. Aceite lubricante general con PTFE

Ref.	Código	Capacidad ml	€/ u.
8004829	1741/1	400	8,11



Lubricante protector anticorrosivo. 3-36 FPS



Lubricante multifunción y protector anticorrosivo de alto rendimiento. Hasta tres meses en interior. Desplaza y aísla de la humedad. Protege todo tipo de metales y aleaciones. NSF certificado alimentación - H2.

Ref.	Código	Capacidad	€/ u.
1105404	1031658	250 ml	6,95
1105400	1030013	500 ml	13,15
1105401	1030018	5 L	86,30
1105402	1030573	20 L	285,00
1105403	1030576	200 L	2.080,00



Lubricante multiuso alto rendimiento. 5-56 + PTFE



Lubricante multiuso alto rendimiento con PTFE. Para una función de lubricación más exigente, en aplicaciones industriales, se añade PTFE. Actúa extremadamente bien cuando ocurren arranques/paradas frecuentes o movimientos alternos en los equipos. Desplaza la humedad, evita averías eléctricas. Suministra una buena protección contra la corrosión.



Ref.	Código	Descripción	Capacidad	€/ u.
1100480	1032539	5-56 + PTFE 2-SPRAY	500 ml	10,70
1100481	1031539	5-56 + PTFE	5 L	70,90

WD-40 Specialist lubricante seco PTFE



ANTIFRICCIÓN. Lubrica y protege dejando una película resistente a la suciedad. Para su uso en metales, plásticos y vidrio. Facilita el desmoldaje. NSF H2. Pulverizador doble acción.



Ref.	Código	Capacidad ml	€/ u.
1113083	34394/NBA	400	11,56

Grasa Sintética extrema presión - SYNTHETIC GREASE



Grasa sintética multiuso de alto rendimiento y uso general. Se aplica como un aceite y se adhiere como una grasa. Excelente resistencia al agua, contiene inhibidor de corrosión. Funcional en un amplio rango de temperaturas desde -40°C hasta 180°C. Proporciona una lubricación a largo plazo con muy buena estabilidad a la oxidación. Segura con la mayoría de gomas, plásticos y revestimientos.



Ref.	Código	Capacidad ml	€/ u.
1510001	1031595	500	15,30

Tensa correas



Formulador para evitar que patinen todo tipo de correas.



Ref.	Código	Capacidad ml	€/ u.
1137223	37223	500	14,57

Antideslizante de correas. BELT GRIP FPS



Antideslizante de correas para industria alimentaria. Certificado NSF - H1 Resistente al agua. Ayuda a la transmisión de fuerza entre ejes paralelos. Evita el deslizamiento y chirridos. Diseñado para usar en áreas de procesamiento de alimentos donde puede ocurrir un contacto accidental con los alimentos. Previene el patinaje de correas excepto en correas dentadas. CRC Belt Grip aumenta el poder de transmisión entre la correa y pulea. Proporciona una tracción mejorada y permite el funcionamiento con una tensión de correa reducida.



Ref.	Código	Capacidad ml	€/ u.
1510000	1031557	500	16,13

White lithium grease+PTFE. WHITE LITHIUM GRASE + PTFE



Grasa compleja de Litio con PTFE para aplicaciones a bajas velocidades y cargas medias. Grasa de Litio blanca de alta pureza, NLGI 2, con aditivo de PTFE para lubricaciones de calidad. Esta grasa posee una consistencia blanda para una cubrición superficial más óptima. No gotea. Grasa seca que no atrae el polvo ni la suciedad. Su acabado de color blanco permite identificar el punto de lubricación con rapidez

Ref.	Código	Capacidad ml	€ / u.
1105500	1030668	500	13,25



Inhibidor de corrosión. SP 400 II



Inhibidor de corrosión. Inhibidor de corrosión con consistencia cerosa. Anticorrosivo de larga duración para exteriores y transporte marítimo. 2 años en exterior y 3 en interior. Protección de moldes, utillajes, utillajes, piezas mecánicas, etc

Ref.	Código	Capacidad	€ / u.
1100485	1031612	250 ml	15,49
1100486	1030299	5 L	148,40
1100487	1030302	20 L	486,75



Lubricante sintético de silicona. SILICONE IND



Hasta 200°C. Lubrica y protege. Película protectora fina y transparente que resiste un amplio rango de temperatura (desde -40° C hasta + 200° C). Lubricante de alta calidad apropiado para piezas de diferentes materiales.

Ref.	Código	Capacidad ml	€ / u.
1100490	1031591	500	11,87



Profesional lubricante de silicona



Lubrica y protege sin dañar metales, gomas, madera o plásticos. No gotea y actúa como aislante. Ayuda a repeler el agua y aislar partes eléctricas. Ideal para sistemas eléctricos y electrónicos, máquinas expendedoras, desmoldeo, sistemas de ignición, cajas de fusibles, equipos de proceso y manipulación alimentaria. Rango de temperatura de utilización: -40°C a 200°C. Compatibilidad con la industria alimentaria NSF: 130363, Categoría H2.

Ref.	Código	Capacidad ml	€ / u.
1510600	34082	250	8,88



Lubricante de silicona



Fluido de silicona antiadherente. Gran poder desmoldeante.

Ref.	Código	Capacidad ml	€ / u.
1510710	36733	500	9,99



WD-40 Specialist lubricante de silicona



LUBRICANTE DE SILICONA. FÓRMULA EXCLUSIVA. Lubricación resistente a la fricción y a altas temperaturas (hasta 200°C). Compatible con plásticos y gomas. Lubrica y protege válvulas de irrigación. Lubrica todo tipo de juntas, incluidos materiales de plásticos y gomas. NSF H2. Pulverizador doble acción.

Ref.	Código	Capacidad ml	€ / u.
1113085	34377/NBA	400	11,56



Pasta antigripante libre de metal. METAL FREE PASTE



Pasta cerámica de montaje y desmontaje para aplicaciones desde -400 °C hasta 1.4000 °C. Previene los contactos metal con metal en condiciones de arranque pesado o en aplicaciones a altas temperaturas.

Ref.	Código	Capacidad ml	€ / u.
1111101	1031690	250	13,24



Pasta antigripante de aluminio. ALU PASTE



Hasta 600°C. Ayuda con el montaje de piezas roscadas gruesas y superficies deslizantes de acero.

Ref.	Código	Capacidad ml	€ / u.
1100492	1031287	500	16,95



Aceite de corte de alta calidad. SUPER CUT II



Aceite de corte de baja viscosidad para operaciones de corte de metal. Aceite de corte alto rendimiento, no clorado. Reduce el calor generado por la fricción, refrigera transfiriendo el calor de la herramienta de corte y elimina las virutas del área de corte. Aumenta la vida de la herramienta considerablemente, facilita el corte y protege contra la oxidación. Para metales ferrosos y no ferrosos

Ref.	Código	Capacidad	€ / u.
1111600	1031678	250 ml	8,63
1111601	1030569	1 L	26,45
1111602	1030339	5 L	92,61
1111603	1030570	20 L	259,35



WD-40 Specialist aceite de corte



Mejora las operaciones realizadas con maquinaria de corte, alargando la vida útil de las herramientas de corte y perforación. Facilita el corte de metal y reduce la acumulación de calor. Reduce la fricción previniendo el desgaste durante el corte o perforación. Pulverizador doble acción.

Ref.	Código	Capacidad ml	€ / u.
1113082	34109/NBA	400	11,56



Aceite corte y roscado



Lubricante refrigerante con características para el roscado.

Ref.	Código	Capacidad ml	€ / u.
1136773	36773	500	18,06



Aceite de roscado de alta calidad. SUPER TAPPING FLUID II



Aceite de roscado de alta viscosidad para operaciones de presión extremas. Aceite de roscado alto rendimiento no clorado. Diseñado para aplicaciones alta presión. Reduce el calor formado por la fricción, absorbiendo el calor de la herramienta de corte y elimina las virutas del área de corte. Aumenta la vida de la herramienta considerablemente y protege las piezas de la oxidación. Indicado para metales duros y aleaciones.

Ref.	Código	Capacidad	€ / u.
1100495	1031673	250 ml	11,22
1100496	1030599	1 L	34,64
1100497	1030347	5 L	121,24



Taladrina verde. TL-75



Taladrina Verde. TL-75

Ref.	Código	Capacidad L	€ / u.
8004824	1086/5	5	27,90
8004823	1086/25	25	139,50
8004825	1086/50	50	279,00



Taladrina blanca. TL-200



Especial para todo tipo de mecanizados, torneado, taladro, serrado e incluso fresado y rectificado de materiales duros. Impide la corrosión de las piezas mecanizadas, protegiendo a las máquinas y herramientas de la oxidación. Resistencia altísima a la descomposición evitando malos olores.

Ref.	Código	Capacidad L	€ / u.
1106600	1088	5	41,50
1106601	1089	25	207,50
1106602	1090	50	415,00



Aceite hidráulico FH-46 EP



Aceite hidráulico de extrema presión con viscosidad ISO VG 46. Homologado por los principales fabricantes de maquinaria.

Ref.	Código	Capacidad L	€ / u.
1147585	47585	5	24,78
1147586	47586	20	72,28
1147580	47580	200	733,17
1147581	47581	1.000	3,51



47585

47586

47580

Vaselina filante



VASELINA FILANTE. Blanca

Ref.	Código	Capacidad KG	€/ u.
8004826	1718/1	1	19,92



Lubricante industria alimentaria



Gama completa de lubricantes con certificación NSF - H1. Para usar en equipos de procesamiento de alimentos.



Ref.	Código	Denominación	Características	Capacidad	€/ u.
1120117	1031572	Pen Oil Fps	Aflojatado enfriador. NSF certificado alimentación - H1	500 ml	13,95
21030008	1031564	Extreme Lube	Lubricante sintético extrema presión NLGI 2. -40°C a 200°C.	500 ml	17,05
21030009	1030901	Silicone	Aceite dieléctrico sintético. -40°C a 200°C	500 ml	15,31
1110267	1032574	Chain Lube Fps	Lubricante de cadenas en espuma de alta duración con PTFE. NSF certificado alimentación - H1	400 ml	20,80
1130033	1030427	Chain Lube Fps	Lubricante de cadenas en espuma de alta duración con PTFE. NSF certificado alimentación - H1	5 L	150,80
1132457	1031461	Ep Food Grease Fps	Grasa alimentaria extrema presión. Resistencia a temperatura hasta 165°C. NSF certificado alimentación - H1	400 gr	19,95
21030010	1030442	Extreme Lube	Lubricante sintético extrema presión NLGI 2. -40°C a 200°C.	400 gr	22,10
1132456	1032027	Ht Food Grease Fps	Grasa alimentaria extrema presión. Resistencia a temperatura hasta 220°C. NSF certificado alimentación - H1	400 gr	35,22
21030011	1031569	Multi Oil	Lubricante multiuso y aceite penetrante. -20°C a +150°C	500 ml	18,60
21030012	1030261	Multi Oil	Lubricante multiuso y aceite penetrante. -20°C a +150°C	5 L	94,33
1120109	1031566	Assembly Paste Fps	Pasta de montaje. Antigripante alta temperatura 1400°C. NSF certificado alimentación - H1	500 ml	18,01
1120120	1030256	Assembly Paste Fps	Pasta de montaje. Antigripante alta temperatura 1400°C. NSF certificado alimentación - H2	500 gr	65,85

Grasa de litio KL



Para todo tipo de rodamientos y cojinetes lisos, articulaciones, guías, ejes estriados, husillos, etc. en aquellos mecanismos que trabajen entre -30 °C y +130 °C.

Ref.	Código	Capacidad	€/ u.
1107000	15403	400 gr	7,13
1107001	15404	1 kg	11,72
1107002	15402	2 kg	20,07
1107003	15405	5 kg	45,85
1107004	15407	20 kg	173,23



Profesional grasa de litio



Lubricación de larga duración, previene el óxido y la corrosión, resiste altas temperaturas y ambientes húmedos (-20°C a +140°C), reduce la fricción y el desgaste en pieza y cadenas.

Ref.	Código	Capacidad	€/ u.
1510500	34083	Spray de 250 ml	8,88
1510501	34608	Tubo de 150 gr	6,60
1510502	34094	Cartucho de 400 gr	7,43



Grasa de litio KL



Grasa de litio de engrase general (NLGI 2). Elevada protección a la corrosión. Buen comportamiento en presencia de agua.



Ref.	Código	Descripción	Capacidad g	€/ u.
2402990	15393	Grasa de Litio	150	6,93

Grasa de litio complejo K2 PLEX



Complejo altas prestaciones. Grasa de alto rendimiento con MoS2 para rodamientos y cojinetes. Apropiado para mecanismos sometidos a altas cargas.



Ref.	Código	Capacidad	€/ u.
1510900	52223	400 gr.	12,20
1510901	52224	1 Kg.	23,16
1510902	52225	5 Kg.	111,00
1510903	52227	20 Kg.	356,65

Grasa



Ref.	Código	Descripción	Capacidad	Características	€/ u.
1130566	1030691	Grasa Multiuso	100 ml	Grasa universal EP. Base de jabón de Litio. Buenas propiedades anticorrosión. Hasta 130°C	2,75
1130571	1030695		400 gr		5,60
1130572	1030697		1 kg		14,02
1130570	1030701	High Temp Grease	100 ml	Grasa compleja de Litio para temperaturas de hasta 200°C. Recomendada para rodamientos en motores y lubricación de larga duración	3,90
1130573	1030703		400 gr		7,90
1130574	1030705		1 Kg		21,50
1130575	1030717	Super Adhesive Grease	100 ml	Grasa compleja de Litio para condiciones extremas: vibraciones, impactos y en ambientes de elevada humedad y suciedad. Hasta 140°C	4,10
1130576	1030716		400 gr		8,40
1130577	1030713		1 Kg		21,60
1130565	1030689	Super Longt.Grease + MoS2	100 ml	Grasa EP a base de jabón de Litio, con Disulfuro de Molibdeno MoS2. Cargas mecánicas extremas y fricción mixta hasta 130°C	3,68
1130578	1030709		400 gr		6,65
1130579	1030710		1 kg		17,50

Grasa cálcica KCS



Grasa cálcica para engrase "perdido" (articulaciones, ballestas, chasis, quinta rueda, etc.). Temperaturas de servicio -10 °C hasta +65 °C.



Ref.	Código	Capacidad kg	€/ u.
1107100	15452	2	14,31
1107101	15455	5	33,00

Grasa multiuso, grado alimentario. FOOD GREASE FPS



Grasa multiuso, grado alimentario. Resistencia a temperatura hasta 140°C. NSF certificado alimentación - HL.



Ref.	Código	Capacidad	€/ u.
1100510	1031380	500 ml	16,50
1100511	1030263	400 gr	18,35
1100512	1030100	1 kg	44,12
1100513	1030622	20 kg	571,26

Grasa de Alto rendimiento



Nueva grasa de alto rendimiento enriquecida con sulfonato de calcio. Desarrollada para trabajos de mantenimiento donde se conjuguen altas cargas vibrantes y/o choque y temperatura.



Ref.	Código	Capacidad	€/ u.
20010000	341077	Cartucho de 400 gr	11,56
20010001	341075	Tubo de 150 gr	9,05

Grasa en spray



Lubricante especial de larga duración.



Ref.	Código	Descripción	Capacidad ml	€/ u.
1510702	33953	Grasa MoS2	400	16,81
1510701	33943	Grasa de Litio	400	13,10
1133973	33973	Grasa alta temperatura	400	15,87
1510704	33983	Grasa de Silicona	500	14,20
1510706	33993	KP-6 Spray	500	16,45
1510700	33963	Grasa en spray	500	10,14
1133933	33933	Grasa spray con PTFE	500	13,97

Grasa en spray



Ref.	Código	Características	Capacidad ml	€/ u.
21135035	970003SPPT	Su lubricación es limpia, con un rendimiento superior a la media. Excelente para la lubricación de cadenas y transmisiones. Es un lubricante de uso universal. No daña las juntas y anillos O-ring. Resiste a la acción del agua gracias a su adhesividad, no se malgasta producto. Excelente para las cadenas de bicicletas y motocicletas porque tiene un poder que repele el polvo. Resiste hasta 300°C	400	7,65
21135036	959003	Grasa en spray de Litio con una excelente calidad y concentración. Garantiza una excelente lubricación y protección anticorrosiva a lo largo del tiempo. Resiste la acción de lavado en agua salada. Garantiza una perfecta estabilidad mecánica incluso en presencia de vibraciones. Resiste a temperaturas de hasta 180°C	400	7,65
21135037	992003	Grasa lubricante para altas temperaturas. Resiste más de 1200°C. No se seca incluso en un ambiente salado. Adecuado para las estampación de materiales plásticos y preso - fusión de metales en todas las situaciones donde se requiere una grasa para altas temperaturas.	400	7,95
21135038	968003	Grasa lubricante con excelente resistencia al rozamiento y desgaste mecánico. Resiste a la mayoría de sustancias ácidas y alcalinas. Resistencia térmica a más de 200°C de temperatura. Inodoro e incoloro. No repele pinturas y colas.	400	7,65
21135039	972SDESPPT	Lubricante - Protectorio - Impermeabilizante - Hidrorepelente - Abrillantador. Es un lubricante multiusos excepcional a base de aceite de silicona pura de alta calidad. Resiste el agua salada del mar. Inodoro e incoloro. Rango de temperatura -38/+270°C.	400	8,35

WD-40 Specialist grasa en spray



LARGA DURACIÓN. Lubricación y protección contra el óxido para largos periodos de tiempo gracias a su textura en gel. Lubrica rieles de puertas correderas, ventanas y portones. Lubrica y protege contra la corrosión y el óxido durante largos periodos de tiempo. Pulverizador doble acción



Ref.	Código	Capacidad ml	€ / u.
1113086	34217/NBA	400	11,56

Grasa lubricante adhesiva. HIGH SPEED CHAIN OIL



Grasa Adhesiva para cadenas a alta velocidad. Alta penetración. Hasta 150°C. Penetra profundamente entre las cadenas de transmisión y los engranajes formando una película adherente y lubricante de larga duración. Indicado incluso en aplicaciones de carga de gran velocidad y alto rendimiento, en condiciones donde se puede producir corrosión



Ref.	Código	Capacidad ml	€ / u.
8000391	1031414	500	11,46

WD-40 Specialist grasa blanca de litio



Ofrece una lubricación larga y duradera, resistente a altas temperaturas y a la humedad. NSF H2



Ref.	Código	Capacidad ml	€ / u.
8001591	34390/NBA	400	11,56

Grasa de litio y titanio



B-MOL EP-2. Grasa de óxido de litio y titanio



Ref.	Código	Capacidad ml	€ / u.
8004827	2107/1	400	9,04

Grasa adhesiva + PTFE



GREASE ADHESIVA+ PTFE. Grasa adhesiva



Ref.	Código	Capacidad ml	€ / u.
8004828	1859/1	400	7,35

Grasa de silicona. SILICONE GREASE



Grasa de silicona. Permite un montaje suave de sellantes base elastómero. Forma una película incolora, sin endurecer que elimina chirridos, uniones y agarrotamientos. Protege metales, aleaciones, plásticos y gomas.



Ref.	Código	Capacidad ml	€ / u.
8000392	1031269	100	8,43
8000393	1030762	400	10,87

Desatascador profesional



Enérgico desatascador profesional de naturaleza ácida y gran actividad. Producto de muy alta densidad, lo que permite disolver eficazmente obturaciones rompiendo su masa orgánica y dejando las tuberías y desagües. Contiene inhibidores de corrosión: no daña plásticos, gomas, hierro, acero, plomo, PVC etc. Elimina eficazmente obturaciones, rompiendo su masa orgánica y dejando las tuberías y desagües perfectamente limpias. perfectamente limpias. Disuelve papel, colillas, compresas, trapos, algodón, restos de comida, grasas, cabellos, etc.



Ref.	Código	Capacidad L	€ / u.
21104003	1028	1	7,95

Bomba de engrase a palanca - 500 c.c.



Bombas universales para utilización con cartuchos y grasa a granel, bien sea cargada por aspiración o con dispensador de grasa. Fijación de varilla de carga opcional según modelo (Serie SG o AN). Robusta cabeza de hierro fundido. Incluyen empuñadura antideslizante. Suministradas en estuche. Bombas universales para utilización con cartuchos y grasa a granel, bien sea cargada por aspiración o con dispensador de grasa. Fijación de varilla de carga opcional según modelo (Serie SG o AN). Robusta cabeza de hierro fundido. Incluyen empuñadura antideslizante. Suministradas en estuche.



Ref.	Código	Descripción	€ / u.
1700000	101202	Fijación de varilla con trinquete modelo 12-SG/0	28,10
1700001	109912	Fijación de varilla con pasador modelo 12-AN/0	32,00
1700002	101200	Con acoplamiento rígido, varilla con trinquete modelo 12-SG	33,10
1700003	109910	Con acoplamiento rígido, varilla con pasador modelo 12-AN	37,00
1700004	101240	Con acoplamiento flexible, varilla con trinquete modelo 12-SG/1	37,95
1700005	109913	Con acoplamiento flexible, varilla con pasador modelo 12-AN/1	41,85

Bomba de engrase a palanca - 1000 c.c.



Con depósito de alta capacidad para utilizar con grasa o a granel.



Ref.	Código	Descripción	€ / u.
1700200	101800	Con acoplamiento rígido, varilla con trinquete modelo 18 -SG	44,00

Bomba de engrase a palanca - 600 c.c.



Bombas con depósito de gran capacidad para utilizar con grasa a granel cargada por aspiración, con dispensador de grasa o utilizando espátula. Fijación de varilla de carga opcional según modelo (Serie SG o AN). Robusta cabeza de hierro. Incluyen empuñadura antideslizante. Suministradas en estuche.

Ref.	Código	Descripción	€ / u.
1700100	101302	Fijación de varilla con triquete modelo 13 - SG/0	32,00
1700101	109927	Fijación de varilla con pasador modelo 13 - AN/0	33,60
1700102	101300	Con acoplamiento rígido, varilla con triquete modelo 13 - SG	37,00
1700103	109925	Con acoplamiento rígido, varilla con pasador modelo 13 - AN	38,60
1700104	101340	Con acoplamiento flexible, varilla con triquete modelo 13 - SG/1	41,85
1700105	109928	Con acoplamiento flexible, varilla con pasador modelo 13 - AN/1	43,45



Bomba de engrase a palanca compacta - 300 c.c.



Bomba compacta para utilizar con grasa a granel.

Ref.	Código	Descripción	€ / u.
1700300	109900	Con acoplamiento rígido, varilla con pasador modelo 10 - AN	33,30



Bomba de engrase a palanca industrial - 500 c.c.



Bomba con émbolo de carga muy robusto, que puede hacerse solidario de la varilla para mejor introducción en cartuchos. Con válvula de relación de presión variable, purgador, válvula de llenado, pistón templado, válvula anti-retorno desmontable. Presión máx. hasta 700 bar.

Ref.	Código	Descripción	€ / u.
1700400	100900	Con acoplamiento rígido, modelo 15 - HD	69,00



Kit bomba engrase a palanca industrial - 500 c.c.



Kit bomba de engrase profesional con maletín y accesorios. Incluye bomba de accionamiento manual a palanca industrial. Cabeza de bomba realizada en fundición con mecanismo de embolada variable. Válvula purgador de aire, boquilla de llenado, palanca con empuñadura. Émbolo de empuje adecuado para el llenado por succión, cartucho, granel o dispensador. Depósito de grasa en acero 500 cc. Presión de entrega hasta: 700 bar. Conexión salida de grasa: 1/8" NPT. Accesorios incluidos: Racord de engrase rígido y flexible con boquilla hidráulica. Acoplamiento rápido para conexión de boquillas. Racord con boquilla plana. Maletín realizado en termoplástico de alta resistencia.

Ref.	Código	Descripción	€ / u.
1700995	100995	15-HD/BOX Kit bomba engrase profesional 500 cc.	189,00



Pistola neumática - 1.000 c.c.



Pistolas con ratio de presión 60/1 para conectar a una línea de aire comprimido o al circuito de un camión. Caudal 1 cm³/embolada. Presión máxima de alimentación aire 10 bar.

Ref.	Código	Descripción	€ / u.
1700700	167500	Capacidad 1.000 c.c. Con émbolo de empuje de grasa neumático, ideal para grasas duras y bajas temperaturas. Incorpora acoplamiento flexible y boquilla hidráulica. Llenado por dispensador o con espátula. Modelo 75	186,00
1700701	168600	Capacidad 500 c.c. Con émbolo de grasa accionada por resorte para utilización con cartuchos, llenado por aspiración o con dispensador. Incorpora acoplamiento flexible y boquilla hidráulica. Modelo 76	166,00



Pistola para engrase manual - 500 c.c.



Para engrase en puntos de difícil acceso al accionar con una sola mano. Carga a granel, por aspiración, con cartucho o con dispensador. Presión máxima hasta 250 bar.

Ref.	Código	Descripción	€/ u.
1700600	106200	Con acoplamiento rígido, modelo 62 -SG	50,00



Boquilla de engrase hidráulicas.



Grapas realizadas en acero endurecido. Todas las boquillas hidráulicas disponen de conexión 1/8" NPT (H). Máxima presión de trabajo 500 bar.

Sin válvula de retroceso

Ref.	Código	Descripción	€/ u.
1721011	121011	Boquilla Ø 15 mm L=37 mm / 4 grapas. BH-101	3,90
1721050	121050	Boquilla Ø 18 mm L=43 mm / 3 grapas. BH-105	10,00



Con válvula de retroceso

Ref.	Código	Descripción	€/ u.
1721020	121020	Boquilla Ø 15 mm L=37 mm / <4 grapas. BH-102	4,70
1721000	121000	Boquilla Ø 15 mm L=37 mm / 3 grapas. BH-100	5,90

Boquilla de engrase



Ref.	Código	Descripción	€/ u.
1700900	124011	Boquilla de engrase Zerk. Cóncava. Engrasador Din 3402. Modelo BZ - 101/1	3,50
1700901	123011	Boquilla de engrase punta. Engrasadores "Lub" DIN 3405. Modelo BT - 101/1	3,50
1700902	123001	Boquilla de engrase punta gigante. Modelo BT - 100	9,30
1700903	126200	Boquilla punta caucho. Para orificios de lubricación. Modelo BT - 103	14,70

Ref.	Código	Descripción	€/ u.
1700904	126500	Boquilla de engrase punta fina. Accesos difíciles. Modelo BT - 102	15,50
1700905	126400	Unión giratoria 90° MF 1/8". Utilizar con flexible. Modelo UG - 90°	39,30
1700906	126000	Boquilla de engrase cardan profesional. Conector rápido macho. Modelo BC - 100	46,00
1700909	128501	Para boquilla hidráulica Ø 18 mm. Conector rápido macho. Modelo CRG - 18M	48,00

Acoplamiento flexible



Acoplamientos de alta resistencia. Presión de trabajo máxima: 500 bar. Presión mínima de rotura: 1.750 bar. Conexión 1/8" NPT (M). Para engrase a alta presión con bomba neumática, pistola neumática o con bomba manual. Con boquilla [121011]



Ref.	Código	Longitud mm	€/ u.
1701000	141020	290	14,70
1701002	141040	400	18,10
1701003	141050	500	19,10

Ref.	Código	Longitud mm	€/ u.
1701004	141200	2.000	45,70
1701005	141400	4.000	75,70

Engrasador hidráulico rectos MT-503



Ref.	Código	Paso rosca	Material	€/ u.
1701200	11065	M6 x 1,00	INOX	1,70
1701201	11145	M8 x 1,00	INOX	1,90
1701202	11225	M10 x 1,00	INOX	2,40

Ref.	Código	Paso rosca	Material	€/ u.
1701203	11265	M10 x 1,50	INOX	2,45
1701204	11605	1/8 GAS - 28h	INOX	2,45
1701205	11625	1/4 GAS - 19h	INOX	4,30

Engrasador hidráulico acodado MT-506 y MT-508. 45°



Ref.	Código	Paso rosca	€/ u.
1701400	13060	M6 x 1,00	0,75
1701401	13100	M7 x 1,00	0,90
1701402	13140	M8 x 1,00	0,80
1701403	13160	M8 x 1,00	0,72
1701405	13220	M10 x 1,00	0,80
1701406	13240	M10 x 1,25	0,90
1701407	13260	M10 x 1,50	0,90
1701408	13280	M12 x 1,00	1,40
1701409	13300	M12 x 1,25	1,24
1701410	13320	M12 x 1,50	1,35
1701411	13340	M12 x 1,75	1,73

Ref.	Código	Paso rosca	€/ u.
1701412	13600	1/8 GAS - 28h	0,78
1701413	13620	1/4 GAS - 19h	1,15
1701414	13500	1/4 SAE - 28h	0,89
1701415	13520	5/16 SAE - 24h	0,89
1701416	13540	3/8 SAE - 24h	1,05
1701417	13700	1/4 W - 20h	0,83
1701418	13720	5/16 W - 16h	0,83
1701419	13740	3/8 W - 16h	0,93
1701420	13900	1/8 NPT - 27H	1,05
1701421	13910	1/4 NPT - 18H	1,35

Engrasador hidráulico acodado MT-506 y MT-508. 90°



Ref.	Código	Paso rosca	€/ u.
1701500	15060	M6 x 1,00	0,72
1701501	15100	M7 x 1,00	0,90
1701502	15140	M8 x 1,00	0,72
1701503	15160	M8 x 1,00	0,72
1701504	15180	M9 x 1,00	0,93
1701505	15220	M10 x 1,00	0,78
1701506	15240	M10 x 1,25	0,89
1701507	15260	M10 x 1,50	0,89
1701508	15280	M12 x 1,00	1,75
1701509	15300	M12 x 1,25	1,75

Ref.	Código	Paso rosca	€/ u.
1701510	15320	M12 x 1,50	1,75
1701511	15340	M12 x 1,75	1,75
1701512	15600	1/8 GAS - 28h	0,78
1701513	15620	1/4 GAS - 19h	1,15
1701514	15500	1/4 SAE - 28h	0,78
1701515	15520	5/16 SAE - 24h	0,86
1701516	15540	3/8 SAE - 24h	1,05
1701517	15700	1/4 W - 20h	0,83
1701520	15900	1/8 NPT - 27H	0,99
1701521	15910	1/4 NPT - 18H	1,35

Engrasador maquinaria industrial MT-862



Ref.	Código	Diámetro mm	€/ u.
1701600	31939	6	0,67
1701601	31949	8	0,78

Ref.	Código	Diámetro mm	€/ u.
1701602	31950	10	0,67
1701603	31960	12	0,78

Engrasador LUB MT-873



Ref.	Código	Para rosca	€/ u.
1701700	32060	M6 x 1,00	0,83
1701701	32160	M8 x 1,25	0,88
1701702	32220	M10 x 1,00	1,14

Ref.	Código	Para rosca	€/ u.
1701703	32260	M10 x 1,50	1,14
1701704	32600	1/8 GAS - 28H	1,14
1701705	32620	1/4 GAS - 19H	1,75

Engrasador cabeza hexagonal 15 mm MT-150



Ref.	Código	Para rosca	€/ u.
1701800	21060	M6 x 1,00	1,05
1701802	21140	M8 x 1,00	1,05
1701803	21160	M8 x 1,25	1,05
1701804	21220	M10 x 1,00	1,05
1701806	21260	M10 x 1,50	1,24

Ref.	Código	Para rosca	€/ u.
1701807	21280	M12 x 1,00	1,24
1701808	21300	M12 x 1,25	1,24
1701809	21320	M12 x 1,50	1,24
1701812	21600	1/8 GAS - 28H	0,94
1701813	21620	1/4 GAS - 19H	0,94

Engrasador cabeza plana doble hexágono 15 mm. MT-153



Ref.	Código	Para rosca	€/ u.	Ref.	Código	Para rosca	€/ u.
1701900	22160	M8 x 1,25	1,91	1701903	22600	1/8 GAS	1,91
1701901	22220	M10 x 1,00	1,91	1701904	22620	1/4 GAS	1,91
1701902	22260	M10 x 1,50	1,91				

Engrasador cabeza plana redonda Ø 16 mm MT-156



Ref.	Código	Para rosca	€/ u.	Ref.	Código	Para rosca	€/ u.
1702000	23220	M10 x 1,00	1,91	1702002	23620	1/4 GAS	1,91
1702001	23600	1/8 GAS	1,91	1702003	23640	3/8 GAS	1,91

Engrasador cabeza plana redonda Ø 22 mm MT-157



Ref.	Código	Para rosca	€ / u.	Ref.	Código	Para rosca	€ / u.
1702100	24620	1/4 GAS	4,45	1702101	24640	3/8 GAS	4,45



Engrasador cabeza plana redonda Ø 22 mm MT-930



Ref.	Código	Para rosca	€ / u.	Ref.	Código	Para rosca	€ / u.
1702200	25620	1/4 GAS	5,50	1702201	25640	3/8 GAS	5,50



Engrasador Stauffer



Ref.	Código	Descripción	Para rosca	€ / u.
1702300	91601	1/8 GAS	Modelo 1-9A. Capacidad: 2,2 c.c.	11,00
1702301	91622	1/4 GAS	Modelo 2- 1/4-A. Capacidad: 5,0 c.c.	14,00
1702302	91623	1/4 GAS	Modelo 3-A. Capacidad: 10,0 c.c.	15,00
1702303	91624	1/4 GAS	Modelo 4-A. Capacidad: 17,0 c.c.	17,00



Protector para engrasadores hidráulicos



Ref.	Código	Descripción	€ / u.
1799030	99030	Capuchón para engrasador color rojo. Modelo MTCH-R	0,28
1799031	99031	Capuchón para engrasador color amarillo. Modelo MTCH-Y	0,28
1799060	99060	Capuchon con anilla, rojo para M6. Modelo MTCHA-R	0,28
1799061	99061	Capuchon con anilla, amarillo para M6. Modelo MTCHA-Y	0,28
1799000	99000	Anilla para M6. Modelo MT-AM6	0,28
1799001	99001	Anilla para M8. Modelo MT-AM8	0,28
1799002	99002	Anilla para M10. Modelo MT-AM10	0,28



Aceitera Metal Lube



Aceiteras con depósito metálico, bomba de pistón de accionamiento mediante palanca con pulsador. Dos extensiones de salida, flexible y rígida de 150 mm.

Ref.	Código	Descripción	€ / u.
1705210	175200	Aceitera metal lube capacidad 300 g. Modelo MSM-300	17,00



Medidor graduado con extensión flexible



Para servicio de lubricantes, anticongelantes, gasóleo, etc. Moldeados en polietileno de alta densidad.

Ref.	Código	Descripción	€/ u.
1706000	675001	Graduado 0 - 1 L. Modelo M-1	11,00
1706001	675002	Graduado 0 - 2 L. Modelo M-2	14,40
1706002	675003	Graduado 0 - 3 L. Modelo M-3	15,70
1706004	675005	Graduado 0 - 5 L. Modelo M-5	24,50



Embudo con extensión flexible



Permite un vaciado rápido de aceites y otros fluidos sin desbordamiento ni salpicaduras. Con tamiz y extensión flexible para accesos difíciles.

Ref.	Código	Descripción	€/ u.
1705900	670019	Embudo con filtro y extensión flexible, Ø 190 mm, 5 L. Modelo E-1	13,50
1705901	670023	Embudo con filtro y extensión flexible, Ø 230 mm, 3,5 L. Modelo E-2.	20,00



Bomba industrial a pedal con depósito 5 kg.



Bomba de engrase muy robusta, accionamiento muy confortable a pedal. Para todo tipo de grasas, con émbolo de compactación de grasa empujado por muelle para utilización con las grasas más duras. Presión máxima 500 bar. Entrega por ciclo de pedal: 2 grs. Depósito estanco, muy robusto y fácilmente transportable. Bomba con purgador de aire, flexible de alta presión de 2 m y boquilla con válvula.

Ref.	Código	Descripción	€/ u.
1702600	157000	Modelo 70	390,00



Bomba multipresión con depósito oval de 16 kg.



Bomba de engrase muy robusta, de gran capacidad, con palanca ajustable en tres posiciones alternativas para su utilización en cualquier condición de funcionamiento, con todo tipo de lubricantes (invierno/verano; grasas duras, blandas y aceite). Presión variable de 175 a 350 bar con gran entrega por ciclo de accionamiento: 20 gr, 15 gr o 10 gr según la posición de la palanca. Depósito estanco muy robusto de forma oval para facilitar el transporte y el accionamiento de la bomba. Incorpora flexible de alta presión 1,5 m con boquilla.

Ref.	Código	Descripción	€/ u.
1702700	150000	Modelo BMP-16	340,00



Dispensador para rellenado de bombas



Para el llenado rápido, limpio y fácil de bombas manuales o pistolas de engrase provistas de válvula de llenado. Incluye bomba con dos terminales, adecuados para las válvulas de llenado más habituales (Ø 9 y 12,5 mm), tapa de bidón y disco seguidor.

Ref.	Código	Descripción	€/ u.
1702900	108000	Para bidón de 12-18 kg. (Ø tapa 310 mm.) Modelo DG - 18	206,00
1702901	108050	Para bidón de 20 kg. (Ø tapa 330 mm.). Modelo DG - 20	226,00
1702902	108100	Para bidón de 50 kg. (Ø tapa 405 mm.). Modelo DG - 50.	242,00



Bomba de alta presión para bidón de grasa



Bomba de engrase construida en acero para acoplamiento directo sobre bidones de grasa. Presión máxima 350 bar. Entrega por ciclo 2 c.c. La bomba dotada de empuñadura de transporte va provista de tapa con adaptador, disco seguidor y flexible de 1,5 m terminando en acoplamiento rígido con boquilla.

Ref.	Código	Descripción	€ / u.
1702800	151102	Para bidones de 20 kg. (Ø 330 mm.) Modelo BAP - 20	290,00
1702801	151100	Para bidones de 12 kg. (Ø 310 mm.) Modelo BAP - 12	278,00



Equipo neumático para engrase móvil carenado 12-20 kg. con bomba PM3+3



Equipo móvil con bomba neumática PM3+3 60:1 y carenado de protección del bidón que facilita su utilización con bidones originales de grasa desde 12 hasta 20 Kg. Para engrase forzado punto a punto.

Ref.	Código	Descripción	Modelo	€ / u.
1703102	486210	Equipo engrase carenado 12/20 kg	EGC-20/450	1.203,00



Equipo neumático de engrase móvil con bomba PM3



Conjunto móvil de bomba PM3 para utilizar con cualquier tipo de bidón de grasa de 12,5/18 kg, 20 kg o 50 kg. Incluye bomba, tapa para bidón, 3 m de manguera pistola control alta presión y carro portabidones de 3 ruedas.

Ref.	Código	Descripción	€ / u.
1703200	424150	Para bidón 12,5/18 kg. Modelo ENG-18/450	674,00
1703201	424152	Para bidón 20 kg. Modelo ENG-20/450	674,00
1703202	425150	Para bidón 50 kg. Modelo ENG-50/725	724,00



Equipo estacionario de engrase de 185 kg.



Conjunto estacionario provisto de bomba neumática. 1 manguera de servicio de 4 m. y pistola de control de grasa. Para engrase punto a punto a alta presión con todo tipo de grasas hasta NLGI-2. Caudal aproximado: 350 gr/min.

Ref.	Código	Descripción	€ / u.
1703401	428262	Equipo estacionario bomba PM3	794,00
1703402	426263	Equipo estacionario bomba PM3+3	1.166,00



Dispensador de aceite para bidón de 205 litros



Dispensador con contador.
 Incluye bomba de ratio 3:1.
 Caudal de trabajo 6 l/min.
 Fijación de bomba directa a bidón.
 Manguera de 3 m para fluido de Ø ½".
 Indicado para utilización con todo tipo de aceites hasta SAE90.
 Pistola contadora electrónica y carro.



Ref.	Código	Descripción	€ / u.
1512100	376300	Modelo DANP-200/31	986,00

Dispensador móvil de aceite con bomba PM2 3:1



Dispensador móvil con bomba neumática de aspiración remota, enrollador de manguera, pistola contadora electrónica y carro con freno. Indicado para utilización con todo tipo de aceites.



Ref.	Código	Descripción	€ / u.
1708120	378120	Dispensador móvil de aceite para bidón 205 l. Modelo DANPC-200/31-M	1.720,00

Dispensador de aceite con pistola simple



Dispensador de aceite de 60 l. con contador.
 Incluye bomba de ratio 3:1, h=700 con adaptador M 2" G.
 Tapa Ø 405 mm.
 Manguera de 3 m para fluido de Ø 1/2" G.
 Para la utilización con todo tipo de aceites hasta SAE 90.
 Pistola-contadora electrónica con extensión flexible 90°.
 Carro portabidones de 4 ruedas.



Ref.	Código	Descripción	€ / u.
1512200	370400	Para bidón de 60 l. Modelo DAN-50/31	869,00

Dispensador de aceite neumático con depósito de 65 l.



Dispensador de aceite carenado con contador y depósito autoportante de 65 l. Incluye bomba de ratio 3:1, h=700 mm. Caudal 6 l/min. Manguera de 3 m para fluido de Ø 1/2". Para utilización con todo tipo de aceites hasta SAE 90. Pistola contadora electrónica con extensión flexible 90°.



Ref.	Código	Descripción	€ / u.
1704100	328010	Depósito de 65 l. Modelo DAC-65/31- P	991,00

Dispensador neumático de valvolina



Bomba de ratio 2:1, h=450 mm con adaptador M 2" G. Para utilización únicamente con lubricantes de transmisiones y caja de cambios hasta SAE 90. Depósito móvil portante de 25 l. Manguera de 1,5 m para fluido Ø 1/2", MM 1/2" G. Pistola de control de lubricante con extensión rígida giratoria 110°. Contador electrónico a la salida de la bomba. Adaptador 45°-MM 1/2" G.

Ref.	Código	Descripción	€/ u.
1704700	327020	Depósito 25 l. Modelo DAC - 25/21-L	942,00



Dispensador aceite manual con depósito autoportante



Dispensador móvil provisto de depósito autoportante con capacidad para alojar 65 litros de lubricante. Incluye: indicador de nivel, bomba manual de accionamiento a palanca y manguera de servicio 1,5 m con válvula de salida y extensión curva 135°.

Ref.	Código	Descripción	€/ u.
1704850	326000	Dispensador con depósito 65 L.	485,00



Bomba para distribución de aceite



Bombas neumáticas de media presión (ratio 3:1) con adaptador roscado 2" y tubo de aspiración adecuado para bidón de 205 l. Adecuada para la distribución de todo tipo de aceites minerales independientemente de su viscosidad con una regulación del caudal al accionar el gatillo de la pistola. Incluye bomba de ratio 3:1, h=920 mm. Caudal 10 l/min. Manguera de 3 m para fluido de Ø 1/2" G.

Ref.	Código	Descripción	€/ u.
1705000	454110	Con pistola contadora electrónica. Modelo DNE-200/31 I	676,00
1705001	454111	Con pistola de control de aceite con extensión flexible. Modelo DNE-200/31-L	528,00

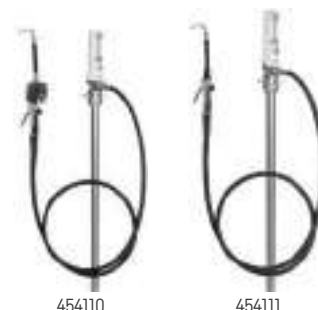

454110

454111

Bomba equipada 3:1



Bomba neumática de media presión con aspiración por toma inferior del contenedor de 1.000 l, fijada en soporte vertical de sencilla instalación. Incluye bomba ratio 3:1, h=230. Soporte mural de bomba. Fijación H 2" G. Flexible de aspiración. Adaptador para toma inferior del contenedor. Codo 90° MH 3/4" G. Soporte vertical para fijación de la bomba al contenedor con soporte para manguera y pistola. Manguera de 6 m para fluido de Ø 1/2". Pistola contadora electrónica.

Ref.	Código	Descripción	€/ u.
1705200	454150	Modelo DNEC-1000/31/V	944,00



Bomba manual de transvase



Bomba de accionamiento a palanca para transvasar todo tipo de lubricantes ligeros y otros fluidos no corrosivos desde bidones de 60 o 205 l. Entrega 0,45 l por golpe de palanca [16 l/min).



Ref.	Código	Descripción	€ / u.
1705100	304500	Modelo 45	58,80

Aspirador de aceite usado



Aspirador móvil para recuperación, incluye bomba de vacío acoplada directamente al depósito para la aspiración. Depósito de almacenamiento de 100 lts. de capacidad.



Ref.	Código	Descripción	€ / u.
1705700	372600	Modelo EVACUATOR-100	722,00

Bomba sumergible para agua limpia



TP 6600



TP 7500 SI



TP 8000 S



TP 12000 SI



TP 13000 S



TPF 7000 S



TPF 6600 SN



TDP 7501 S

Ref.	Código	Modelo	Potencia W	Altura máx. tte. m	Presión máx. bar	Peso Kg	€ / u.
1100520	80250660000	TP 6600	250	6,0	0,60	4,3	147,29
1100521	80250750013	TP 7500 SI	300	6,5	0,65	4,2	251,32
1100522	80250800000	TP 8000 S	350	7,0	0,70	4,3	160,68
1100523	80251200009	TP 12000 SI	600	9,0	0,90	4,1	315,18
1100524	80251300000	TP 13000 S	550	9,5	0,95	5	270,89
1100525	80250800002	TPF 7000 S	450	6,0	0,60	4,6	258,53
1100526	80250660006	TPF 6600 SN	450	6,0	0,60	4,6	239,99
1100527	80250750100	TDP 7501 S	1.000	34,0	3,40	9,1	444,96

Bomba sumergible para aguas sucias



PS 7500 S



PS 15000 S



PS 18000 SN

Ref.	Código	Modelo	Potencia W	Altura máx. tte. m	Presión máx. bar	Peso Kg	€/ u.
1100530	80250750000	PS 7500 S	450	5	0,50	4,8	210,12
1100531	80251500000	PS 15000 S	850	9,5	0,95	6,5	425,39
1100532	80251800000	PS 18000 SN	1.100	11	1,10	7,9	541,78

Bomba sumergible combinada



TPS 14000 S Combi



TPS 16000 S Combi

Ref.	Código	Modelo	Potencia W	Altura máx. tte. m	Presión máx. bar	Peso Kg	€/ u.
1100540	80251400000	TPS 14000 S Combi	770	8,5	0,85	7,7	290,46
1100541	80251600000	TPS 16000 S Combi	970	9,5	0,95	7,8	338,87

Bomba para obras y aguas sucias



SP 28-50 S Inox



DP 18-5 SA



DP 28-10 S Inox

Ref.	Código	Modelo	Potencia W	Altura máx. tte. m	Presión máx. bar	Peso Kg	€/ u.
1100546	604114000	SP 28-50 S Inox	1.470	12	1,2	19,3	1.362,69
1100548	604112000	DP 28-10 S Inox	1.850	17	1,7	18,5	1.573,84

Bomba sumergible para agua limpia



Estas motobombas equipadas con un motor de gasolina son capaces de mover grandes cantidades de agua, ya sea en una inundación o para llenar un estanque.



Ref.	Código	Altura máx. tte. m	Caudal l/min	COMBUSTIBLE	Cilindrada cm ³	Marca/Modelo	Dimensiones mm	Peso kg.	€ / u.
2402991	FA360EH1000	30m	600	Gasolina	118	Honda	470x365x390	26	595,00
2402992	FA560HH1000	26m	930	Gasolina	163	Honda	477x416x466	28	665,00

Bomba sumergible para agua sucia



Estas motobombas equipadas con un motor de gasolina son capaces de mover grandes cantidades de agua, ya sea en una inundación o para llenar un estanque.



Ref.	Código	Altura máx. tte. m	Caudal l/min	COMBUSTIBLE	Cilindrada cm ³	Marca/Modelo	Dimensiones mm	Peso kg.	€ / u.
2402994	FC340DH1000	27m	1.340	Gasolina	242	Honda	690x485x537	59	1.170,00

Tubería coarrugada con lámina de aluminio ALUMINIO COMPACTO. Color STANDARD



Muy flexible, fácil de manejar. Estanco, resistente hasta +300 °C. Aplicaciones: Aspiración de humos y gases de tipo doméstico e industrial. Ventilación en general.



Ref.	Código	Espesor pared mm	M/caja	Ø exterior mm	Ø Int. mm	€ / m.
2001200	2170080	4,5	150	89	80	7,53
2001201	2170090	4,5	125	99	90	8,64
2001202	2170100	4,5	100	109	100	9,17
2001203	2170110	4,5	80	119	110	9,71
2001204	2170120	4,5	80	129	120	10,58
2001205	2170125	4,5	80	134	125	11,59
2001206	2170130	4,5	60	139	130	12,79
2001207	2170140	4,5	45	149	140	13,95
2001208	2170150	4,5	45	159	150	17,58

Ref.	Código	Espesor pared mm	M/caja	Ø exterior mm	Ø Int. mm	€ / m.
2001209	2170160	4,5	45	169	160	20,01
2001210	2170180	4,5	30	189	180	25,69
2001211	2170200	4,5	20	209	200	30,60
2001212	2170225	4,5	20	234	225	36,15
2001213	2170250	4,5	20	259	250	44,78
2001214	2170300	4,5	10	309	300	8,06
2001215	2170350	4,5	5	359	350	8,06
2001216	2170400	4,5	5	409	400	8,06
2001217	2170450	4,5	5	459	450	8,06

Atóxica TRANSFORT SUPERELASTIC



Tubería reforzada en su interior por un espiral rígido prácticamente indeformable y antichoque, el espiral está recubierto de material flexible. Superficie interior lisa para evitar la formación de sedimentos en las paredes y así facilitar la esterilización. Soporta temperatura entre -25 °C y +60 °C. Buena resistencia a la aspiración e impulsión, a la abrasión, a los agentes atmosféricos y a diversos productos químicos. Aplicaciones: Drenaje de pozos negros, sentinas, riego industrial, bombeo por aspiración e impulsión de purinas y productos químicos. Transporte neumático de semillas y cereales. Transporte de polvos y gránulos.



Ref.	Código	Espesor pared mm	Largo rollo m	Ø Int. mm	Peso gr/ml	Presión rotura bar	Presión servicio bar	Radio curvatura mm	Vacio m H2O	€/ m.
2000100	12200040	4,5	50	40	730	18	6	160	9	30,94
2000101	12200045	5,0	50	45	900	18	6	180	9	36,12
2000102	12200050	5,2	50	50	1.050	15	5	200	9	42,52
2000103	12200060	5,5	50	60	1.250	13,5	4,5	240	9	58,05
2000104	12200063	6,0	50	63	1.390	13,5	4,5	250	9	59,93
2000105	12200070	6,0	50	70	1.600	13,5	4,5	280	9	68,30
2000106	12200075	6,5	50	75	1.700	12	4	300	9	72,22
2000107	12200080	6,5	50	80	1.850	10,5	3,5	320	9	79,83
2000108	12200090	6,7	30	90	2.250	10,5	3,5	360	9	92,42
2000109	12200102	7,3	30	102	2.700	9	3	410	9	118,54
2000110	12200110	7,5	30	110	3.100	9	3	440	9	134,05
2000111	12200120	8,0	30	120	3.600	7,5	2,5	480	9	150,49
2000112	12200125	8,3	30	125	3.900	7,5	2,5	500	9	155,27
2000113	12200150	9,0	30	150	5.000	6	2	600	9	226,75
2000114	12200200	13,0	10	200	10.000	6	2	800	9	477,68

Aspiración industrial



Tubería flexible fabricada en EVA (etil-vinilo-acetato). Muy resistente a las deformaciones permanentes. Resistente a los rayos UVA, al frío y a la rotura en el alargamiento. Soporta temperaturas entre -30 °C y +60 °C. Aplicaciones: Aspiración de aire, polvo, humo de soldadura, gases...



Ref.	Código	Largo rollo m	Ø exterior mm	Ø Int. mm	Peso gr/ml	Radio curvatura mm	Vacio m H2O	€/ m.
2001500	3193025	30	35	25	180	56	6	4,83
2001501	3193032	30	41	32	260	64	6	6,10
2001502	3193038	30	48	38	300	76	6	8,12
2001503	3193045	30	55	45	450	90	6	8,66
2001504	3193050	30	61	50	520	100	6	9,02
2001505	3193060	30	72	60	650	120	5	12,19

Atóxica ESPIROFUEL



Tubería muy flexible reforzada en su interior por un espiral rígido prácticamente indeformable y antichoque, que le da gran consistencia, el espiral está recubierto de material flexible. Superficie interior lisa para evitar la formación de sedimentos en las paredes y así facilitar la esterilización. Resiste a los agentes atmosféricos, a diversos productos químicos, a los hidrocarburos, derivados del petróleo y a la abrasión. Temperatura recomendada de empleo entre -15 °C y +60 °C. Aplicaciones: Aspiración e impulsión de productos petrolíferos y derivados.



Ref.	Código	Espesor pared mm	Largo rollo m	Ø Int. mm	Peso gr/ml	Presión rotura bar	Presión servicio bar	Radio curvatura mm	Vacio m H2O	€ / m.
2000300	18100025	4,3	50	25	550	21	7	160	7	23,80
2000301	18100030	4,5	50	30	680	15	5	192	7	25,97
2000302	18100035	4,5	50	35	750	15	5	224	7	30,09
2000303	18100040	4,5	50	40	850	15	5	256	7	34,06
2000304	18100045	5,5	50	45	1.000	15	5	288	7	40,00
2000305	18100050	5,5	50	50	1.200	15	5	320	7	47,89
2000306	18100060	6	50	60	1.600	15	5	384	7	64,02
2000307	18100065	6	50	65	1.700	15	5	403	7	70,06
2000308	18100070	6,3	50	70	1.900	15	5	448	7	75,39
2000309	18100075	6,5	50	75	2.000	15	5	480	7	79,98
2000310	18100080	6,7	30	80	2.200	12	4	512	7	87,98
2000311	18100090	7	30	90	2.600	12	4	576	7	103,97
2000312	18100100	7	30	100	3.300	12	4	640	6	132,02

URARTU



Manguera interior lisa y exterior corrugada en PVC para aspiración de humo, aire, gas y polvo. Rango de temperatura -10 °C a 60 °C



Ref.	Código	Diámetro interior mm	Diámetro exterior mm	Depresión m/H2O	Radio de curvatura mm	Peso gr/m	Longitud Rollo m	€ / m.
8002867	122020	20	25	0,4	20	125	50	2,47
8002868	122025	25	30	0,4	25	150	50	3,09
8002869	122030	30	35	0,35	30	190	50	3,92
8002870	122035	35	40	0,35	35	230	50	4,74
8002871	122040	40	45	0,3	45	280	50	5,77
8002872	122045	45	51	0,3	45	350	50	7,00
8002873	122050	50	56	0,3	50	395	50	8,14
8002874	122060	60	67	0,3	60	500	50	10,30
8002875	122063	63	70	0,3	65	520	50	10,71
8002876	122070	70	77	0,3	70	580	50	11,95
8002877	122075	76	84	0,3	85	640	50	13,18
8002878	122080	80	88	0,3	90	730	50	15,04
8002879	122090	90	98	0,3	100	780	30	16,07
8002880	122100	100	109	0,3	110	970	30	19,99
8002881	122110	110	120	0,3	125	1.100	30	22,66
8002882	122120	120	130	0,3	135	1.200	30	24,72
8002883	122125	127	137	0,3	140	1.250	30	25,75
8002884	122130	130	141	0,3	145	1.350	30	27,81
8002885	122140	140	151	0,3	150	1.525	30	31,42
8002886	122150	152	162	0,25	160	1.600	20	32,96
8002887	122160	160	172	0,25	180	1.800	20	37,08
8002888	122180	180	192	0,25	200	2.000	20	41,20
8002889	122200	203	213	0,2	240	2.400	20	49,44
8002890	122250	254	265	0,2	320	2.800	10	69,33
8002891	122300	300	315	0,2	400	3.200	10	135,66

Atóxica y de uso alimentario con espiral metálica TRANSMETAL



Tubería muy flexible, reforzada en su interior por una espiral rígida metálica en acero galvanizado cubierta con una capa de PVC rígida. Superficie interior lisa para evitar la formación de sedimentos en las paredes y así facilitar la esterilización. Resistente a la presión, al vacío y al aplastamiento accidental. Muy buen aguante a la abrasión gracias al espiral externo. Resiste a los agentes atmosféricos y a diversos productos químicos. Aplicaciones: Bombas de vacío, maquinaria agrícola, irrigación, construcción, fábricas químicas, cisternas para transporte de barro, aspiración de grano y agua potable.



Ref.	Código	Espesor pared mm	Largo rollo m	Ø Int. mm	Peso gr/ml	Presión rotura bar	Presión servicio bar	Radio curvatura mm	Vacio m H2O	€/ m.
2000403	17350010050	3,5	50	20	340	30	10	40	9	7,61
2000405	17350013050	4,2	50	30	630	27	9	60	9	10,21
2000406	17350016050	4,2	50	32	660	27	9	64	9	12,48
2000407	17350018050	4,3	50	35	750	27	9	70	9	14,75
2000408	17350020050	4,5	50	38	800	27	9	76	9	17,03
2000409	17350025050	4,8	50	40	950	27	9	80	9	24,47
2000410	17350030050	4,8	30	42	1.040	27	9	84	9	28,08
2000411	17350032050	4,9	30	45	1.150	27	9	90	9	31,32
2000412	17350035050	5,4	30	50	1.300	21	7	100	9	34,23
2000413	17350038050	5,4	30	55	1.460	18	6	110	9	38,34
2000414	17350040030	6	30	60	1.750	18	6	120	9	39,39
2000415	17350042030	6,1	30	65	1.900	15	5	130	9	44,36
2000416	17350045030	6,1	30	70	2.100	15	5	140	9	51,09
2000417	17350055030	6,5	30	75	2.250	15	5	150	9	59,49
2000418	17350060030	6,5	30	80	2.500	12	4	160	9	67,79
2000419	17350065030	7	30	90	2.900	12	4	180	9	72,64
2000420	17350076050	7	30	100	3.650	9	3	200	9	98,60
2000421	17350080030	7,2	30	105	3.850	9	3	210	9	105,24
2000422	17350090030	7,2	30	110	3.950	9	3	220	9	124,39
2000423	17350102030	8	30	120	4.300	9	3	240	9	159,10
2000424	17350110030	8	30	125	4.600	9	3	250	9	174,12
2000425	17350125030	10	20	150	6.600	7,5	2,5	300	9	203,08

Acuaflex



Manguera de PVC monocapa para riego, conducción e impulsión de líquidos, uso en bombas sumergibles etc. Temperatura de uso -10° a 60 ° C.



Ref.	Código	Diámetro interior mm	Diámetro exterior mm	Peso gr/m	Longitud Rollo m	€/ m.
2403049	115040	20	24	160	50	3,00
2403050	115050	25	29	195	50	3,46
2403051	115063	30	34	230	50	4,73
2403052	115075	35	39	280	50	5,67
2403053	115090	40	44	325	50	7,07
2403054	115100	45	49	355	50	8,50
2403055	115125	52	56	410	50	17,85
2403056	115150	60	64	540	50	21,41
2403057	115200	63	69	565	50	33,70

Planex Negra PVC



Manguera de PVC para descarga de aguas, químicos suaves etc así como para uso en bombas sumergibles y de superficie. Apta para la conducción de aire para compresores.



Ref.	Código	Diámetro interior mm	Diámetro exterior mm	Peso gr/m	Longitud Rollo m	€ / m.
2403058	195020	20	24	160	50	2,78
2403059	195025	25	29	195	50	3,40
2403060	195030	30	34	230	50	3,94
2403061	195035	35	39	280	50	4,87
2403062	195040	40	44	325	50	5,41
2403063	195045	45	49	355	50	5,87
2403064	195052	52	56	410	50	6,56
2403065	195060	60	64	540	50	8,65
2403066	195063	63	69	565	50	9,04
2403067	195070	70	75	620	50	9,89
2403068	195076	76	81	685	50	10,97
2403069	195080	80	85	740	50	11,82
2403070	195090	90	95	870	50	13,90
2403071	195102	100	107	1.000	50	15,99
2403072	195110	110	116	1.150	50	18,38
2403073	195152	152	158	1.650	50	26,33
2403074	195200	200	207	2.300	50	36,76

TEKNO CRISTAL



Manguera de PVC liso transparente para nivel de maquinaria, conducción de aire y líquidos. Rango de temperatura de -5 °C a 60 °C



Ref.	Código	Diámetro interior mm	Diámetro exterior mm	Peso gr/m	Longitud Rollo m	€ / m.
8002434	1270305	3	5	16	50	0,28
8002435	1270306	3	6	28	50	0,48
8002436	1270406	4	6	20	50	0,35
8002438	1270508	5	8	40	50	0,70
8002439	1270608	6	8	29	50	0,50
8002440	1270609	6	9	46	50	0,80
8002441	1270610	6	10	65	50	1,12
8002442	1270612	6	12	85	50	1,91
8002443	1270710	7	10	52	50	0,90
8002444	1270712	7	12	95	50	1,66
8002445	1270810	8	10	37	50	0,63
8002446	1270811	8	11	58	50	1,02
8002447	1270812	8	12	82	50	1,40
8002448	1270912	9	12	64	50	1,11
8002449	1270915	9	15	147	50	2,55
8002450	1271012	10	12	45	50	0,77
8002451	1271014	10	14	98	25/50	1,70
8002452	1271016	10	16	159	50	2,74

Ref.	Código	Diámetro interior mm	Diámetro exterior mm	Peso gr/m	Longitud Rollo m	€ / m.
8002453	1271215	12	15	83	50	1,43
8002454	1271216	12	16	114	50	2,00
8002455	1271218	12	18	184	50	3,18
8002456	1271319	13	19	184	50	3,40
8002457	1271418	14	18	131	50	2,27
8002458	1271519	15	19	139	50	2,40
8002459	1271520	15	20	179	50	3,09
8002460	1271620	16	20	147	50	2,55
8002461	1271823	18	23	209	50	3,60
8002462	1272025	20	25	230	50	3,98
8002463	1272228	22	28	306	50	5,36
8002464	1272531	25	31	343	50	5,92
8002465	1273036	30	36	479	50	7,02
8002466	1273545	35	45	637	50	14,14
8002467	1274050	40	50	919	50	15,94
8002468	1274555	45	55	950	50	17,75
8002469	1275060	50	60	1.123	50	19,48

Atóxica y de uso alimentario AGROMEDIUM



Tubería reforzada en su interior por un espiral rígido prácticamente indeformable y antichoque, el espiral está recubierto de material flexible y transparente de calidad alimentaria. Superficie interior lisa para evitar la formación de sedimentos en las paredes y así facilitar la esterilización. Buena resistencia a la aspiración e impulsión. Resiste a los agentes atmosféricos y a diversos productos químicos. Temperatura recomendada de empleo entre -10 °C y + 60 °C. Aplicaciones: Trasvase de fertilizantes, insecticidas, antihongos. Bombeo por aspiración e impulsión. Riego industrial.



Ref.	Código	Espesor pared mm	Largo rollo m	Ø Int. mm	Peso gr/ml	Presión rotura bar	Presión servicio bar	Radio curvatura mm	Vacio m H2O	€/ m.
2000200	22410050	5	50	50	960	20	5	250	9	34,69
2000201	22410055	5	50	55	1.120	20	5	275	9	40,43
2000202	22410060	5,5	50	60	1.300	20	5	300	9	45,98
2000203	22410070	6	50	70	1.520	20	5	350	9	54,46
2000204	22410075	6	50	75	1.600	20	5	375	9	57,13
2000205	22410080	6	50	80	1.700	16	4	400	9	62,13
2000206	22410090	6	30	90	2.050	16	4	450	9	73,24
2000207	22410100	7	30	100	2.650	12	3	500	9	93,27
2000208	22410110	7	30	110	2.850	12	3	550	9	115,98
2000209	22410120	7,5	30	120	3.100	21	3	600	9	128,09
2000210	22410125	7,5	30	125	3.200	21	3	625	9	133,59
2000211	22410150	8	20	150	5.000	21	3	750	9	178,51
2000212	22410200	11	10-5	200	8.100	21	2,5	1.000	9	388,22
2000213	22410250	12,5	10-5	250	10.400	10	2,5	1.250	9	493,59
2000214	22410300	13,5	10-5	300	12.000	10	2,5	1.500	9	710,65

Manguera plana flexible atóxica WATERFLAT "M"



Su refuerzo interior textil le permite soportar presiones de hasta 5 bar y por su estructura plana es muy manejable y fácilmente enrollable. La temperatura recomendada de empleo entre -10 °C y +60 °C. Aplicaciones: Trasvase y transporte de agua potable, fertilizantes y otros líquidos en riego agrícola y construcción.

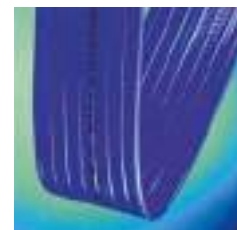

Ref.	Código	Espesor pared mm	Largo rollo m	Ø Int. mm	Peso gr/ml	Presión rotura bar	Presión servicio bar	Dilatación %	Elongación %	Vacio m H2O	€/ m.
2000500	19110025	2,2	100	25	240	30	10	+/-10	+/-7	x	9,00
2000501	19110030	1,4	100	30	200	18	6	+/-10	+/-7	6	10,11
2000502	19110035	1,5	100	35	230	18	6	+/-10	+/-7	6	12,46
2000503	19110040	1,5	100	40	270	18	6	+/-10	+/-7	6	13,59
2000504	19110045	1,5	100	45	290	18	6	+/-10	+/-7	6	14,65
2000505	19110050	1,6	100	50	320	18	6	+/-10	+/-7	6	16,89
2000506	19110063	1,6	100	63	430	16,5	5,5	+/-10	+/-7	5,5	21,92
2000507	19110070	2,2	100	70	620	21	7	+/-10	+/-7	x	23,71
2000508	19110075	1,8	100	75	550	12	4	+/-10	+/-7	4	25,87
2000509	19110080	2,4	100	80	800	21	7	+/-10	+/-7	x	29,38
2000510	19110090	1,8	100	90	660	12	4	+/-10	+/-7	4	32,76
2000511	19110100	2	100	100	760	10,5	3,5	+/-10	+/-7	3,5	37,15
2000512	19110110	2,2	100	110	1.000	10,5	3,5	+/-10	+/-7	3,5	41,56
2000513	19110125	2,5	100	125	1.390	18	6	+/-10	+/-7	x	84,92
2000514	19110150	3,0	50	150	1.800	12	4	+/-10	+/-7	x	98,60

Manguera reforzada de caucho negra BLACK GARDEN



Manguera reforzada en su interior por una malla de hilo de poliéster. Exteriormente estriada y rugosa, de color negro. Soporta temperaturas entre -10 °C y +60 °C. Anti-U.V. Cuarta capa anti-torsión. Aplicaciones: Riego en condiciones duras de trabajo, construcción, obra pública, canteras, riego y aspersión en general.



Ref.	Código	Largo rollo m	Ø exterior mm	Ø Int. mm	Peso gr/ml	Presión rotura bar	Presión servicio bar	€/ m.
2001000	25701519	50	20	15	180	30	10	7,42
2001001	25701925	50	25	19	250	30	10	9,43
2001002	25702532	50	32	25	420	30	10	5,30

Manguera tricotada YELLOW GARDEN



Manguera reforzada en su interior por una malla tricotada de hilo de poliéster, muy resistente a la torsión. Muy flexible y manejable. Soporta temperaturas entre -10 °C y +60 °C. Cuarta capa anti-doblecés, anti-U.V., anti-torsión. Aplicaciones: Riegos agrícolas, jardinería, construcción,...

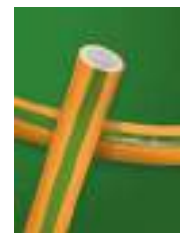

Ref.	Código	Largo rollo m	Ø exterior mm	Ø Int. mm	Peso gr/ml	Presión rotura bar	Presión servicio bar	€/ m.
2001100	23121521	25-50	21	15	210	30	10	14,11
2001101	23121925	25-50	25	19	265	30	10	3,96
2001102	23122532	25-50	32	25	400	30	10	5,40

ALISIOS PUC



Manguera de poliuretano corrugado con refuerzo en espiral de acero cobreado, para aspiración de humos, virutas (madera, metálicas,..) y materiales abrasivos. Rango de temperatura de -40 °C a 90 °C



Ref.	Código	Diámetro interior mm	Espesor mínimo mm	Presión de trabajo bar	Depresión mbar	Radio de curvatura mm	Peso gr/m	Longitud Rollo m	€/ m.
8002411	116030	30	0,4	0,6	250	22	150	10	10,66
8002412	116040	40	0,4	0,6	250	25	200	10	11,94
8002413	116050	50	0,4	0,6	250	27	250	10	13,52
8002414	116060	60	0,4	0,5	250	30	275	6/10	15,74
8002415	116070	70	0,4	0,4	150	35	360	6/10	19,96
8002416	116075	75	0,4	0,4	150	38	390	6/10	20,81
8002417	116080	80	0,4	0,3	100	40	410	6/10	21,96
8002418	116090	90	0,4	0,3	100	45	440	6/10	23,53
8002419	116100	100	0,4	0,3	100	50	515	6/10	24,68
8002420	116110	110	0,4	0,25	75	55	560	6/10	26,61
8002421	116120	120	0,4	0,25	75	60	615	6/10	28,61
8002422	116125	125	0,4	0,25	75	64	645	6/10	30,40
8002423	116130	130	0,4	0,25	75	65	665	6/10	31,19
8002424	116140	140	0,4	0,25	75	60	710	6/10	33,55
8002425	116150	150	0,4	0,25	75	75	765	6/10	36,55
8002426	116160	160	0,4	0,15	50	80	880	6/10	38,48
8002427	116180	180	0,4	0,25	50	90	990	6/10	43,92
8002428	116200	200	0,4	0,25	50	100	1.100	6/10	49,07
8002429	116220	220	0,4	0,25	50	115	1.200	6/10	54,86
8002430	116250	250	0,4	0,1	20	125	1.300	6/10	60,65
8002431	116300	300	0,4	0,1	20	150	1.550	6/10	67,52
8002432	116350	350	0,4	0,1	20	175	1.820	6/10	76,32
8002433	116400	400	0,4	0,1	20	200	2.070	6/10	88,26

Tubo de cristal. Atóxica y de uso alimentario MALLATRANS



Reforzado en su interior. La temperatura recomendada de trabajo entre -10 °C y +60 °C. Aplicaciones: Nivelación en construcción, conducción de líquidos a baja presión y de bajo contenido alcohólico, productos alimentarios de bajo contenido graso, usos clínicos.

Ref.	Código	Largo rollo m	Ø exterior mm	Ø Int. mm	Peso gr/ml	Presión rotura bar	Presión servicio bar	€ / m.
2001400	24010612	100	12	6	110	45	15	3,57
2001401	24010814	100	14	8	135	45	15	4,35
2001402	24011016	50	16	10	155	45	15	6,60
2001403	24011218	50	18	12	180	45	15	9,75
2001404	24011521	50	21	15	215	45	15	11,98
2001405	24011926	50	26	19	315	30	10	14,24
2001406	24012028	50	28	20	385	30	10	16,69
2001407	24012533	50	33	25	465	30	10	30,20
2001408	24013038	50	38	30	545	21	7	53,63
2001409	24014050	25	50	40	900	18	6	30,20
2001410	24015064	25	62	50	1.550	15	5	53,63



Manguera reforzada MALLALATEX



Manguera reforzada en su interior por una malla de hilo de poliéster, muy flexible y manejable. Soporta temperaturas entre -10 °C y +60 °C. Única en el mercado 100% latex. Anti-dobleces, anti-torsión. Aplicaciones: Riegos domésticos, jardinería, horticultura.

Ref.	Código	Largo rollo m	Ø exterior mm	Ø Int. mm	Peso gr/ml	Presión rotura bar	Presión servicio bar	€ / m.
2000900	32101521	15-20-25-50	21	15	150	24	8	12,69
2000901	32101926	25-50	26	19	240	24	8	104,63
2000902	32102532	25-50	32	25	400	24	8	149,38



Manguera reforzada verde ESPIROGARDEN



Manguera reforzada en su interior por una malla de hilo de poliéster, muy flexible y manejable. Soporta temperaturas entre -10 °C y +60 °C. Anti-U.V., anti-algas. Sin dobleces ni torsión. Aplicaciones: Riegos domésticos, jardinería, horticultura.

Ref.	Código	Largo rollo m	Ø exterior mm	Ø Int. mm	Peso gr/ml	Presión rotura bar	Presión servicio bar	€ / m.
2000800	25801521	25-50	21	15	150	30	10	106,09
2000801	25801926	25-50	26	19	240	30	10	162,78
2000802	25802532	25-50	32	25	400	30	10	162,78



Atóxica y de uso alimentario ESPIRO PU



Tubería muy flexible y ligera, reforzada en su interior por una espiral rígida de PVC, antichoque y prácticamente indeformable. Superficie interior lisa para evitar la formación de sedimentos en las paredes y superficie externa corrugada. Grandes propiedades antiabrasivas. Resistente a los agentes atmosféricos y a diversos productos químicos. La temperatura recomendada de empleo entre -20 °C y +80 °C. Aplicaciones: Aspiración e impulsión con contenidos abrasivos como cementos, arenas, granos, azúcar, cereales, serrín, ferralla... Ventilación y conducción de aire, polvo, gases y humos.



Ref.	Código	Espesor pared mm	Largo rollo m	Ø Int. mm	Peso gr/ml	Radio curvatura mm	Vacio m H2O	€/ m.
2000600	34100032	3	30	32	170	32	3	13,43
2000602	34100045	3	30	45	245	45	3	18,56
2000603	34100050	3	30	50	290	50	3	21,44
2000604	34100060	3	30	60	425	60	3	31,06
2000605	34100070	3,5	30	70	500	70	3	36,34
2000606	34100075	3,5	30	75	550	75	3	39,66
2000607	34100080	3,5	30	80	590	80	3	42,51
2000608	34100090	4	30	90	670	90	3	48,16
2000609	34100100	4,5	30	102	800	100	3	53,78
2000610	34100110	5	30	110	900	110	3	64,15
2000611	34100120	5	30	120	1.000	120	3	71,26
2000612	34100125	5	30	125	1.100	125	3	76,16
2000613	34100130	5	30	130	1.200	130	3	77,04
2000614	34100140	5	30	140	1.300	140	3	83,41
2000615	34100150	5,	30	150	1.500	150	3	96,24
2000616	34100160	5,5	30	160	1.700	160	3	114,25
2000618	34100180	6	20	180	1.950	180	3	128,36
2000619	34100200	6	20	200	2.200	200	3	140,14
2000620	34100250	6	20	250	2.600	250	3	210,23
2000621	34100300	6	10	300	3.425	300	3	254,84

PVC flexible transparente TRANSLIQUID



Con espiral rígida prácticamente indeformable y antichoque. Superficie interior lisa para evitar la formación de sedimentos en las paredes y así facilitar la esterilización. Soporta temperaturas entre -10 °C y +60 °C y una presión de vacío de 350 mbar. Aplicaciones: Trasiego de líquidos y alimentos con bajo contenido graso. Bombeo por aspiración e impulsión en riegos agrícolas.



Ref.	Código	Espesor pared mm	Largo rollo m	Ø Int. mm	Peso gr/ml	Presión rotura bar	Presión servicio bar	Radio curvatura mm	Vacio m H2O	€/ m.
2000011	30170015	3	50	15	180	30	10	60	7	7,50
2000012	30170020	3,3	50	20	285	24	8	80	7	8,70
2000013	30170025	3,5	50	25	360	24	8	100	7	10,67
2000014	30170030	3,5	50	30	405	21	7	120	7	14,49
2000015	30170032	3,5	50	32	435	21	7	128	7	13,64
2000016	30170035	3,5	50	35	495	21	7	140	7	14,49
2000017	30170038	3,8	50	38	520	18	6	152	7	15,08
2000018	30170040	4	50	40	540	18	6	160	7	15,68
2000019	30170045	4	50	45	630	18	6	180	7	18,40
2000020	30170050	4	50	50	765	15	5	200	7	22,17
2000021	30170055	4	50	55	810	15	5	220	7	24,12
2000022	30170060	4,5	50	60	900	15	5	240	7	25,97
2000023	30170065	4,5	50	65	990	15	5	260	7	29,69
2000024	30170070	4,5	50	70	1.125	15	5	280	7	33,39
2000025	30170075	4,5	50	75	1.260	12	4	300	7	36,20
2000026	30170080	5	50	80	1.440	12	4	320	7	41,56
2000027	30170090	5	30	90	1.665	12	4	360	7	48,10
2000028	30170100	5,5	30	100	1.980	12	4	400	7	57,25
2000029	30170110	6	30	110	2.250	12	4	440	5	62,93
2000030	30170125	6,5	30	125	2.700	9	3	500	5	72,36
2000031	30170140	7	20	140	3.600	9	3	560	5	99,37
2000032	30170150	7	20	150	3.870	9	3	600	5	108,83
2000033	30170200	8,5	20	200	6.270	6	2	800	5	389,37

Manguera de presión ESPIROPRES 20 y 40 BAR



Atóxica y exenta de metales pesados. Muy flexible y manejable. Reforzada en su interior con una malla de hilo de poliéster. Gran aguante a la absorción de aceites y carburantes. Temperatura recomendada de empleo entre -10 °C y +60 °C. Aplicaciones: Aire comprimido, martillos hidráulicos, compresores.



Presión de 20 bares

Ref.	Código	Largo rollo m	Ø exterior mm	Ø Int. mm	€/ m.
2001700	95400006	100	14	6	4,81
2001701	95400008	100	16	8	6,13
2001702	95400010	100	18	10	6,49
2001703	95400012	100	21	12	9,11
2001704	95400016	50	26	16	11,14
2001705	95400019	50	29	19	13,00
2001706	95400025	50	36	25	19,46

Presión de 40 bares

Ref.	Código	Largo rollo m	Ø exterior mm	Ø Int. mm	€/ m.
2001800	95600008	100	15	8	5,40
2001801	95600010	100	16	10	6,20

Tubería pvc autoextinguible EXTRAFLEX



Tubería muy flexible reforzada en su interior por un espiral rígido prácticamente indeformable y antichoque, que le da gran consistencia, el espiral está recubierto de material flexible. Superficie interior lisa para evitar la formación de sedimentos en las paredes y así facilitar la esterilización. Resiste a los agentes atmosféricos, a diversos productos químicos, a los hidrocarburos, derivados del petróleo y a la abrasión. Temperatura recomendada de empleo entre -15 °C y +60 °C. Aplicaciones: Aspiración e impulsión de productos petrolíferos y derivados.



Ref.	Código	Largo rollo m	Ø Int. mm	Peso gr/ml	Radio curvatura mm	€/ m.
2000700	36100040	10	40	110	20	12,72
2000701	36100050	10	50	120	25	13,23
2000702	36100060	10	60	140	30	15,16
2000703	36100070	10	70	160	35	16,86
2000704	36100075	10	76	175	40	19,83
2000705	36100080	10	80	195	40	20,83
2000706	36100090	10	90	200	45	22,53
2000708	36100110	10	110	270	55	26,91
2000709	36100120	10	120	295	60	29,63
2000710	36100125	10	127	315	63	33,96
2000711	36100130	10	130	325	65	34,67

Ref.	Código	Largo rollo m	Ø Int. mm	Peso gr/ml	Radio curvatura mm	€/ m.
2000712	36100140	10	140	350	70	37,40
2000713	36100150	10	152	370	75	39,46
2000714	36100160	10	160	440	80	41,57
2000715	36100180	10	180	535	90	46,77
2000716	36100200	10	203	600	100	52,89
2000717	36100225	10	225	660	115	58,39
2000718	36100250	10	254	790	125	65,53
2000719	36100300	10	305	950	150	79,00
2000720	36100350	10	356	1.110	175	92,72
2000721	36100400	10	406	1.280	200	104,07

ODEON 80 BAR



Manguera en PVC y goma nitríca para fumigación y aire comprimido en 80 bar.
Rango de temperatura -10 °C a 60 °C



Ref.	Código	Diámetro interior mm	Diametro exterior mm	Presión de trabajo bar	Presión de rotura bar	Radio de curvatura mm	Peso gr/m	Longitud Rollo m	€ / m.
8002471	135008	8	15	80	240	80	180	50/100/500	4,24
8002472	135010	10	18	80	240	100	240	100	5,70
8002473	135012	12	21	80	240	125	310	100	7,99

YAKIT 10 (1900)



Manguera en caucho NBR con refuerzo de hilo sintético de alta fuerza tensora e hilos de cobre embecidos para conducción eléctrica. Rango de temperatura de -35 °C a 80 °C



Ref.	Código	Diámetro interior mm	Diametro exterior mm	Presión de trabajo bar	Presión de rotura bar	Radio de curvatura mm	Peso gr/m	Longitud Rollo m	€ / m.
8002477	157013	13	23	10	30	130	260	40	28,77
8002478	157015	15	26	10	30	150	300	40	30,37
8002479	157019	19	30	10	30	165	420	40	33,56
8002480	157025	25	35	10	30	254	574	40	35,58
8002482	157030	30	40	10	30	280	660	40	41,90
8002483	157032	32	42	10	30	320	716	40	42,74
8002484	157035	35	47	10	30	350	800	40	43,36
8002485	157038	38	48	10	30	380	864	40	54,60
8002486	157040	40	53	10	30	400	924	40	56,57
8002487	157045	45	55	10	30	445	1.064	40	66,85
8002488	157050	50	62	10	30	510	1.276	40	69,28
8002489	157060	60	73	10	30	610	1.510	40	85,06
8002490	157063	63	75	10	30	635	1.632	40	100,55
8002491	157070	70	83	10	30	705	1.820	40	112,65
8002492	157075	75	88	10	30	762	1.984	40	122,51
8002493	157080	80	94	10	30	810	2.350	40	131,20
8002494	157090	90	104	10	30	900	2.723	40	158,02
8002495	157100	100	116	10	30	1.016	3.193	40	179,43
8002497	157125	125	143	10	30	1.270	4.463	20/40	292,21
8002498	157150	150	168	10	30	1.524	5.253	20/40	416,74

PRIME



Manguera 20 bar multifunción en caucho EPDM y con refuerzo textil de alta resistencia. Rango de temperatura de -40 °C a 120 °C



Ref.	Código	Diámetro interior mm	Diametro exterior mm	Presión de trabajo bar	Presión de rotura bar	Radio de curvatura mm	Peso gr/m	Longitud Rollo m	€/ m.
8002499	172006	6	13	20	60	30	125	50	5,35
8002500	172008	8	15	20	60	35	150	50	6,39
8002501	172010	10	18	20	60	40	210	50	7,57
8002502	172013	13	22	20	60	60	295	50	10,63
8002503	172016	16	25	20	60	80	345	50	15,15
8002504	172019	19	29	20	60	90	445	50	19,81
8002505	172025	25	37	20	60	120	690	50	29,05

Planex Roja



Manguera de caucho nitrilo para impulsión de agua contra incendios. Se monta con Racor Barcelona.



Ref.	Código	Diámetro interior mm	Diametro exterior mm	Peso gr/m	Longitud Rollo m	€/ m.
2403075	111025	25	30	235	20-30-60	12,38
2403076	111045	45	50	370	20-30-60	16,02

Planex Negra



Manguera de caucho nitrilo para impulsión de agua contra incendios. Se monta con Racor Barcelona.



Ref.	Código	Diámetro interior mm	Diametro exterior mm	Peso gr/m	Longitud Rollo m	€/ m.
2403077	111070	70	75	350	30-60	24,77
2403078	110025	25	29	235	60	12,38
2403079	110038	38	42	310	60	14,93
2403080	110045	45	49	370	60	16,02
2403081	110050	50	54	450	60	18,21
2403082	110065	65	69	620	60	22,58
2403083	110070	70	75	650	60	24,77
2403084	110075	75	81	680	60	27,31
2403085	110080	80	85	700	60	29,86
2403086	110090	90	95	830	60	33,51
2403087	110100	100	105	950	60	34,60
2403088	110110	110	115	1100	60	41,52
2403089	110125	125	131	1.450	60	52,44
2403090	110150	150	156	1.650	60	72,11
2403091	110200	200	207	2.250	60	105,47
2403092	110250	250	260	4.250	60	261,93
2403093	110300	300	310	5.050	60	335,42

UNIVERSAL 1 SN



Manguera de caucho sintético especial resistente a los hidrocarburos, con refuerzo de 1 malla metálica, y de altas prestaciones en sistemas hidráulicos en industria y agricultura

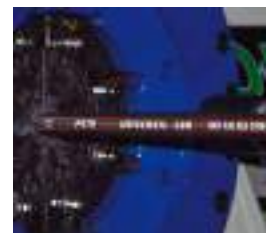

Ref.	Código	Diámetro interior mm	Diametro exterior mm	Depresión m/H71	Radio de curvatura mm	Peso gr/m	Longitud Rollo m	€/ m.
2403094	40191/4	6.4	13.1	-0.8	100	225	de 10 a 150	4,59
2403095	40195/16	8	14.7	-0.8	115	260	de 10 a 150	5,33
2403096	40193/8	9.5	17.1	-0.8	130	340	de 10 a 150	6,14
2403097	40191/2	12.7	20.3	-0.8	180	415	de 10 a 150	7,62
2403098	40195/8	16	23.5	-0.8	200	480	de 10 a 150	9,18
2403099	40193/4	19	27.4	-0.8	240	590	de 10 a 150	11,10
2403100	40191	25.4	35.6	-0.8	300	885	de 10 a 150	14,65
2403101	401911/4	31.8	43.5	-0.6	420	1.225	20	21,09
2403102	401911/2	38.1	50	-0.6	500	1.415	20	24,87

UNIVERSAL 2 SN



Manguera de caucho sintético especial resistente a los hidrocarburos, con refuerzo de 2 mallas metálicas, y de altas prestaciones en sistemas hidráulicos en industria y agricultura

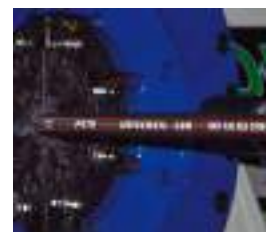

Ref.	Código	Diámetro interior mm	Diametro exterior mm	Depresión m/H81	Radio de curvatura mm	Peso gr/m	Longitud Rollo m	€/ m.
2403103	40291/4	6.4	13.1	-0.95	100	385	de 10 a 150	5,77
2403104	40295/16	8	14.7	-0.95	115	435	de 10 a 150	6,88
2403105	40293/8	9.5	17.1	-0.95	130	550	de 10 a 150	8,36
2403106	40291/2	12.74	20.3	-0.95	180	650	de 10 a 150	10,29
2403107	40295/8	16	23.5	-0.95	200	760	de 10 a 150	11,10
2403108	40293/4	19	27.4	-0.8	240	940	de 10 a 150	13,69
2403109	40291	25.4	35.6	-0.8	300	1.315	de 10 a 150	20,20
2403110	402911/4	31.8	43.5	-0.8	420	1.920	20	25,68
2403111	402911/2	38.1	50	-0.8	500	2.145	20	35,97
2403112	40292	50.8	63.6	-0.8	630	2.800	20	38,71

AIR LONG KOMP 20 BAR



Manguera en 20 bar para impulsión de aire en compresor y herramienta neumática. Rango de temperatura de -25 °C a 80 °C



Ref.	Código	Diámetro interior mm	Diametro exterior mm	Presión de trabajo bar	Presión de rotura bar	Radio de curvatura mm	Peso gr/m	Longitud Rollo m	€/ m.
8002506	141006	6	12	20	60	30	160	100	3,41
8002507	141008	8	15	20	60	35	195	100	4,17
8002508	141010	10	17	20	60	40	270	100	4,73
8002509	141013	13	20	20	60	60	395	50	6,18
8002510	141015	15	25	20	60	75	450	50	9,52
8002511	141019	19	29	20	60	90	585	20/50	10,63
8002512	141025	25	36	20	60	120	890	50	15,84



LONG MULTI 20 BAR



Manguera multifunción 20 bar en caucho NBR. Rango de temperatura -35 °C a 70 °C



Ref.	Código	Diámetro interior mm	Diametro exterior mm	Presión de trabajo bar	Presión de rotura bar	Radio de curvatura mm	Peso gr/m	Longitud Rollo m	€/ m.
8002513	142006	6	13	20	60	30	125	50	5,42
8002514	142008	8	15	20	60	35	150	50	6,53
8002515	142010	10	18	20	60	40	210	50	7,78
8002516	142013	13	22	20	60	60	295	50	10,77
8002517	142016	16	25	20	60	80	345	50	15,43
8002518	142019	19	29	20	60	90	445	50	20,22
8002519	142025	25	37	20	60	120	690	50	29,53

JUPITER OXIGENO DIN ISO 3821



Manguera de caucho microperforado acorde a ISO 3821 para impulsión de oxígeno. Rango de temperatura -30 °C a 80 °C



Ref.	Código	Diámetro interior mm	Diametro exterior mm	Presión de trabajo bar	Presión de rotura bar	Radio de curvatura mm	Peso gr/m	Longitud Rollo m	€/ m.
8002520	147006	6	13	20	60	30	155	100	3,75
8002521	147008	8	15	20	60	40	185	100	4,52
8002522	147010	10	17	20	60	50	220	100	5,63
21029013	147013	13	22	20	60	65	370	100	10,63

JUPITER BITUBO OX/AC DIN ISO 3821



Manguera bitubo de caucho microperforado para la impulsión de oxígeno y acetileno. Rango de temperatura de -30 °C a 80 °C



Ref.	Código	Diámetro interior mm	Diametro exterior mm	Presión de trabajo bar	Presión de rotura bar	Radio de curvatura mm	Peso gr/m	Longitud Rollo m	€/ m.
8002523	150006	6+6	13	20	60	30	320	50/100	8,27
8002524	150008	8+8	15	20	60	40	390	50/101	9,59
8002525	150010	10+10	17	20	60	50	460	50/102	11,05

EGE-20 (1220)



Manguera de caucho SBR para impulsión de aire y agua en 20 bar. Rango de temperatura de -25 °C a 70 °C



Ref.	Código	Diámetro interior mm	Diametro exterior mm	Presión de trabajo bar	Presión de rotura bar	Radio de curvatura mm	Peso gr/m	Longitud Rollo m	€ / m.
8002526	153013	13	22	20	60	65	332	40	13,62
8002527	153016	16	25	20	60	80	374	40	15,84
8002528	153019	19	29	20	60	95	504	40	18,76
8002529	153025	25	36	20	60	125	670	40	28,35
8002530	153030	30	42	20	60	240	850	40	38,71
8002531	153032	32	44	20	60	300	955	40	41,90
8002532	153035	35	48	20	60	340	1.020	40	42,53
8002533	153038	38	51	20	60	360	1.177	40	51,49
8002534	153040	40	54	20	60	380	1.420	40	53,93
8002535	153045	45	60	20	60	400	1.630	40	56,91
8002536	153050	50	65	20	60	450	1.655	40	62,40
8002537	153060	60	80	20	60	600	2.450	40	86,31
8002538	153070	70	86	20	60	700	2.550	40	101,04
8002539	153075	75	92	20	60	750	2.650	40	107,16
8002540	153080	80	96	20	60	800	3.010	40	123,00
8002541	153090	90	108	20	60	900	3.450	40	143,99
8002542	153100	100	118	20	60	1.000	3.800	40	182,83

Racor BARCELONA



Racor barcelona estándar en España



Ref.	Código	Diámetro interior mm	€ / u.
8002565	2010251	25	9,81
8002566	2010451	45	12,81
8002567	2010701	70	21,19
8002568	2010252	25/1	8,48
8002569	2010452	45/11/2	9,90
8002570	2010702	70/ 21/2	22,05
8002571	2010253	25/1	8,57
8002572	2010453	45/11/2	11,76
8002573	2010703	70/ 21/2	18,38
8002574	2010258	25	8,72
8002575	2010458	45	11,66
8002576	2010708	70	16,32

Ref.	Código	Diámetro interior mm	€ / u.
8002577	2010254	25	7,86
8002578	2010454	45	8,90
8002579	2010704	70	33,33
8002580	2010255	25	0,29
8002581	2010455	45	0,57
8002582	2010705	70	0,86
8002583	2010256	25/45	11,91
8002584	2010456	45/70	18,81
8002585	2010257	25/ H1	12,38
8002586	2010457	45/H11/2	19,05
8002587	2010707	70/H2	33,33

Racor GUILLEMIN aluminio



Racor estandar francés en Aluminio. Disponible también en inox



Ref.	Código	DN/PM	€ / u.	Ref.	Código	DN/PM	€ / u.
8002588	2080401	40/40	10,24	8002608	20804022	DN 40/ 11/2	9,38
8002589	2080451	40/45	10,14	8002609	20805022	DN 50/ 2	13,81
8002590	2080501	50/50	14,29	8002610	20806522	DN 65/ 2 1/2	17,43
8002591	2080551	50/55	12,33	8002611	20807522	DN 80/3	22,86
8002592	2080651	65/65	20,05	8002612	20810022	DN 100/4	28,71
8002593	2080701	65/70	20,38	8002613	20804033	DN 40/ 11/2	14,43
8002594	2080751	80/75	26,43	8002614	20805033	DN 50/ 2	20,38
8002595	2080801	80/80	26,05	8002615	20806533	DN 65/ 2 1/2	24,71
8002596	2080901	80/90	26,76	8002616	20807533	DN 80/3	33,00
8002597	2081001	100/100	40,24	8002617	20810033	DN 100/4	43,76
8002598	2080402	DN 40/ 11/2	5,67	8002618	2080404	DN 40	9,57
8002599	2080502	DN 50/ 2	8,62	8002619	2080504	DN 50	13,57
8002600	2080652	DN 65/ 2 1/2	10,29	8002620	2080654	DN 65	15,62
8002601	2080752	DN 80/3	14,14	8002621	2080754	DN 80	21,48
8002602	2081002	DN 100/4	19,24	8002622	2081004	DN 100	27,62
8002603	2080403	DN 40/ 11/2	4,86	8002623	2080406	40/50	28,67
8002604	2080503	DN 50/ 2	6,86	8002624	2080506	80/50	44,67
8002605	2080653	DN 65/ 2 1/2	7,95	8002625	2080656	65/50	37,95
8002606	2080753	DN 80/3	11,86	8002626	2080806	80/65	46,81
8002607	2081003	DN 100/4	14,43	8002627	2081006	100/80	63,00

Racor GUILLEMIN aluminio



Racor de conexión estándar francés

Ref.	Código	diametro	€ / u.
21029014	2080405	40	0,33
21029015	2080505	50	0,57
21029016	2080655	65	0,81
21029017	2080755	80	1,05
21029018	2081005	100	1,38



Racor BARCELONA



Pistola 3 Efectos

Ref.	Código	diametro	€ / u.
21029012	2020458	45	992,88



Racor CAMLOCK aluminio

CAMLOCK Tipo A. Macho rosca hembra

Ref.	Código	Diámetro	€ / u.
8002634	2040151	1/2	1,95
8002635	2040191	3/4	2,33
8002636	2040251	1	2,62
8002637	2040321	1 1/4	3,10
8002638	2040401	1 1/2	3,90

Ref.	Código	Diámetro	€ / u.
8002639	2040501	2	5,19
8002640	2040651	2 1/2	8,00
8002641	2040751	3	8,29
8002642	2041001	4	13,67



CAMLOCK Tipo B. Hembra rosca macho

Ref.	Código	Diámetro	€ / u.
8002643	2040152	1/2	4,52
8002644	2040192	3/4	4,95
8002645	2040252	1	5,81
8002646	2040322	1 1/4	8,86
8002647	2040402	1 1/2	9,19

Ref.	Código	Diámetro	€ / u.
8002648	2040502	2	10,71
8002649	2040652	2 1/2	13,43
8002650	2040752	3	15,91
8002651	2041002	4	21,33



CAMLOCK Tipo C. Hembra con espiga

Ref.	Código	Diámetro	€ / u.
8002652	2040153	1/2	4,67
8002653	2040193	3/4	5,19
8002654	2040253	1	6,29
8002655	2040323	1 1/4	8,67
8002656	2040403	1 1/2	9,19

Ref.	Código	Diámetro	€ / u.
8002657	2040503	2	11,86
8002658	2040653	2 1/2	13,52
8002659	2040753	3	18,19
8002660	2041003	4	24,67



CAMLOCK Tipo D. Hembra con rosca Hembra

Ref.	Código	Diámetro	€ / u.
8002661	2040154	1/2	4,67
8002662	2040194	3/4	5,19
8002663	2040254	1	5,71
8002664	2040324	1 1/4	8,10
8002665	2040404	1 1/2	9,24

Ref.	Código	Diámetro	€ / u.
8002666	2040504	2	10,81
8002667	2040654	2 1/2	13,91
8002668	2040754	3	16,95
8002669	2041004	4	23,29



CAMLOCK Tipo E. Macho con espiga

Ref.	Código	Diámetro	€ / u.
8002670	2040155	1/2	2,67
8002671	2040195	3/4	3,00
8002672	2040255	1	3,67
8002673	2040325	1 1/4	4,67
8002674	2040405	1 1/2	5,48

Ref.	Código	Diámetro	€ / u.
8002675	2040505	2	7,95
8002676	2040655	2 1/2	11,24
8002677	2040755	3	13,33
8002678	2041005	4	20,95



CAMLOCK Tipo F. Macho rosca macho

Ref.	Código	Diámetro	€ / u.
8002679	2040156	1/2	2,86
8002680	2040196	3/4	3,05
8002681	2040256	1	3,62
8002682	2040326	1 1/4	4,33
8002683	2040406	1 1/2	5,95

Ref.	Código	Diámetro	€ / u.
8002684	2040506	2	7,71
8002685	2040656	2 1/2	10,00
8002686	2040756	3	13,14
8002687	2041006	4	21,10



CAMLOCK Tipo DC. Tapón para macho

Ref.	Código	Diámetro	€ / u.
8002688	2040157	1/2	3,19
8002689	2040197	3/4	4,76
8002690	2040257	1	5,81
8002691	2040327	1 1/4	8,10
8002692	2040407	1 1/2	9,14

Ref.	Código	Diámetro	€ / u.
8002693	2040507	2	10,33
8002694	2040657	2 1/2	12,86
8002695	2040757	3	15,43
8002696	2041007	4	20,10



CAMLOCK Tipo DP. Tapón para hembra

Ref.	Código	Diámetro	€ / u.
8002697	2040158	1/2	1,67
8002698	2040198	3/4	1,95
8002699	2040258	1	2,67
8002700	2040328	1 1/4	2,90
8002701	2040408	1 1/2	3,33

Ref.	Código	Diámetro	€ / u.
8002702	2040508	2	5,19
8002703	2040658	2 1/2	6,52
8002704	2040758	3	8,38
8002705	2041008	4	13,10



Racor CAMLOCK polipropileno Tipo A. Macho rosca hembra



CAMLOCK Tipo A. Macho rosca hembra

Ref.	Código	Diámetro	€ / u.
8002706	2050151	1/2	0,71
8002707	2050191	3/4	0,76
8002708	2050251	1	0,81
8002709	2050321	1 1/4	1,14
8002710	2050401	1 1/2	1,29
8002711	2050501	2	1,95
8002712	2050751	3	3,10
8002713	2051001	4	7,62
8002714	2050152	1/2	2,43



CAMLOCK Tipo B. Hembra rosca macho

Ref.	Código	Diámetro	€ / u.
8002715	2050192	3/4	2,57
8002716	2050252	1	2,95
8002717	2050322	1 1/4	4,10
8002718	2050402	1 1/2	4,38
8002719	2050502	2	5,00
8002720	2050752	3	7,29
8002721	2051002	4	13,38
8002722	2050153	1/2	2,48
8002723	2050193	3/4	2,62



CAMLOCK Tipo C. Hembra con espiga

Ref.	Código	Diámetro	€ / u.
8002724	2050253	1	3,14
8002725	2050323	1 1/4	4,29
8002726	2050403	1 1/2	4,43
8002727	2050503	2	5,29
8002728	2050753	3	8,24
8002729	2051003	4	16,29
8002730	2050154	1/2	2,48
8002731	2050194	3/4	2,62
8002732	2050254	1	3,10



CAMLOCK Tipo D. Hembra rosca hembra

Ref.	Código	Diámetro	€ / u.
8002733	2050324	1 1/4	4,14
8002734	2050404	1 1/2	4,43
8002735	2050504	2	5,14
8002736	2050754	3	7,67
8002737	2051004	4	12,86
8002738	2050155	1/2	0,67
8002739	2050195	3/4	0,71
8002740	2050255	1	0,81
8002741	2050325	1 1/4	1,05



CAMLOCK Tipo E. Macho con espiga

Ref.	Código	Diámetro	€ / u.
8002742	2050405	1 1/2	1,29
8002743	2050505	2	2,24
8002744	2050755	3	4,24
8002745	2051005	4	9,43
8002746	2050156	1/2	0,67
8002747	2050196	3/4	0,71
8002748	2050256	1	0,76
8002749	2050326	1 1/4	1,14
8002750	2050406	1 1/2	1,33



Racor CAMLOCK polipropileno Tipo A. Macho rosca hembra



CAMLOCK Tipo F. Tapón para macho

Ref.	Código	Diámetro	€/ u.
8002751	2050506	2	2,14
8002752	2050756	3	3,57
8002753	2051006	4	8,67
8002754	2050157	1/2	2,38
8002755	2050197	3/4	2,48
8002756	2050257	1	2,95
8002757	2050327	1 1/4	3,76
8002758	2050407	1 1/2	4,29
8002759	2050507	2	4,76



CAMLOCK Tipo DC. Tapón para macho

Ref.	Código	Diámetro	€/ u.
8002760	2050757	3	7,24
8002761	2051007	4	12,48
8002762	2050158	1/2	0,38
8002763	2050198	3/4	0,52
8002764	2050258	1	0,57
8002765	2050328	1 1/4	0,90
8002766	2050408	1 1/2	1,00
8002767	2050508	2	1,19
8002768	2050758	3	2,81



CAMLOCK Tipo DP. Tapón para hembra

Ref.	Código	Diámetro	€/ u.
8002769	2051008	4	6,00



Racor EXPRES. Conexión espiga



CONEXIÓN ESPIGA ACANALADA

Ref.	Código	Diámetro	€/ u.
8002798	2100151	15	3,76
8002799	2100191	19	4,05
8002800	2100251	25	4,71



Racor EXPRES. Conexión rosca m



CONEXIÓN ROSCA MACHO

Ref.	Código	Diámetro	€/ u.
8002801	2100152	1/2	3,71
8002802	2100192	3/4	3,76
8002803	2100252	1	4,48



Racor EXPRES. Conexión rosca h



CONEXIÓN ROSCA HEMBRA

Ref.	Código	Diámetro	€ / u.
8002804	2100153	1/2	3,14
8002805	2100193	3/4	3,57
8002806	2100253	1	3,90



Racor EXPRES. Junta



EXPRES JUNTA

Ref.	Código	Diámetro	€ / u.
8002807	2100195	Estandar	0,43



Racor EXPRES. Unión de manguera



UNIÓN DE MANGUERA

Ref.	Código	Diámetro	€ / u.
8002808	2100158	13	1,38
8002809	2100198	19	1,67
8002810	2100258	25	2,38
8002811	2100328	32	3,00
8002812	2100408	40	3,90
8002813	2100508	50	5,38
8002814	2100758	75	12,43
8002815	2101008	100	20,67
8002816	2101258	125	35,29
8002817	2101508	150	45,57
8002818	2102008	200	83,14



Racor EXPRES. Abrazadera doble tornillo sin uña



ABRAZADERA DOBLE TORNILLO SIN UÑA

Ref.	Código	Diámetro	€ / u.
8002819	2100290	22-29	3,14
8002820	2100340	28-34	4,10
8002821	2100400	32-40	4,33
8002822	2100490	39-49	5,00
8002823	2100600	48-60	5,90
8002824	2100750	60-76	6,33
8002825	2100940	77-94	11,95



Racor EXPRES. Abrazadera doble tornillo con uña



ABRAZADERA DOBLE TORNILLO CON UÑA

Ref.	Código	Diámetro	€ / u.
8002826	2100291	22-29	5,81
8002827	2100341	28-34	6,29
8002828	2100401	32-40	8,05
8002829	2100491	39-49	9,10
8002830	2100601	48-60	10,38



Plancha de goma común



Plancha lisa NR/SBR en rollos de 10 metros.

Ref.	Código	Espesor x altura mm	Peso kg/rollo	€ / u.
8002832	3010110	1x1000	15	3,57
8002833	3010112	1x1200	18	3,57
8002834	3010114	1x1400	21	3,57
8002835	3010210	2x1000	30	2,64
8002836	3010212	2x1200	36	2,64
8002837	3010214	2x1400	42	2,64
8002838	3010310	3x1000	45	2,64
8002839	3010312	3x1200	54	2,64
8002840	3010314	3x1400	63	2,64
8002841	3010410	4x1000	60	2,64
8002842	3010412	4x1200	72	2,64
8002843	3010414	4x1400	84	2,64
8002844	3010510	5x1000	75	2,64
8002845	3010512	5x1200	90	2,64
8002846	3010514	5x1400	105	2,64
8002847	3010610	6x1000	90	2,64
8002848	3010612	6x1200	108	2,64
8002849	3010614	6x1400	126	2,64
8002850	3010810	8x1000	120	2,64
8002851	3010812	8x1200	144	2,64
8002852	3010814	8x1400	168	2,64
8002853	3011010	10x1000	150	2,64
8002854	3011012	10x1200	180	2,64
8002855	3011014	10x1400	210	2,64
8002856	3012010	20x1000	300	2,64
8002857	3012012	20x1200	360	2,64
8002858	3012014	20x1400	420	2,64



Pavimento estribera y triangular



Pavimento en caucho con estribera Grabada

Ref.	Código	Espesor x altura mm	M2 x rollo	€ / u.
8002864	3060310	3x1000	10	15,23
8002865	3060315	3x1500	15	15,23
8002866	3070312	3x1200	12	11,57



Alfombra alveolar



Alfombra alveolar de caucho natural



Ref.	Código	Espesor mm	Anchura mm	Largo mm	€ / u.
21029019	313013	12.7	914	1.524	53,95

Checker



Pavimento de goma con grabado tipo checker ó "palillos"



Ref.	Código	Espesor mm	Anchura mm	total m2	€/ u.
21029022	3090310	3	1.000	10	12,93
21029023	3090315	3	1.500	15	12,93

Cortina PVC



Cortinas a láminas de PVC



Ref.	Código	Espesor mm	Anchura mm	longitud m	€/ u.
21029024	3120202	2	200	50	8,99
21029025	3120203	2	300	50	8,99
21029026	3120302	3	200	50	8,99
21029027	3120303	3	300	50	8,99

Placa alveolar encastrable



Placa alveolar encastrable cuadrada de caucho natural



Ref.	Código	Espesor mm	Anchura mm	Largo mm	€/ u.
21029020	313016	16	914	914	51,70

Placa alveolar



Placa alveolar de caucho natural



Ref.	Código	Espesor mm	Anchura mm	Largo mm	€ / u.
21029021	313023	23	1.000	1.500	98,91

Plancha Nitrilo



Plancha de goma especial para aceites e hidrocarburos.



Ref.	Código	Espesor mm	Anchura mm	Peso Rollo kg.	€ / u.
21029028	3140214	2	1.400	42	4,58
21029029	3140314	3	1.400	63	4,58
21029030	3140414	4	1.400	84	4,58
21029031	3140514	5	1.400	105	4,58
21029032	3140614	6	1.400	126	4,58
21029033	3140814	8	1.400	168	4,58
21029034	3141014	10	1.400	210	4,58

Plancha Antiabrasiva



Plancha de goma antiabrasiva con dureza Sh:40+/-5



Ref.	Código	Espesor mm	Anchura mm	Peso Rollo kg.	€ / u.
21029035	3150214	2	1.400	32.2	15,98
21029036	3150314	3	1.400	48.3	15,98
21029037	3150414	4	1.400	64.4	15,98
21029038	3150514	5	1.400	80.5	15,98
21029039	3150614	6	1.400	96.6	15,98
21029040	3150814	8	1.400	128.8	15,98
21029041	3151014	10	1.400	161	15,98



1084
Calibres

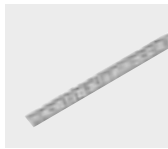

1092
Regla flexible



1101
Niveles



1085
Calibres digitales



1092
Cartabones

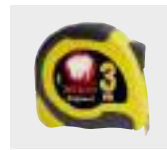

1104
Flexómetros



1086
Calibres de tornero



1092
Transportadores de ángulo



1108
Cintas métricas



1087
Calibres de profundidad



1093
Goniómetros

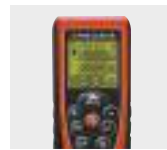

1111
Medidores láser



1087
Relojes comparadores



1093
Compases

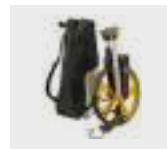

1113
Topómetros



1088
Micrómetros de exteriores



1096
Juegos de galgas



1114
Cronómetros

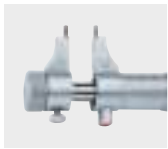

1088
Micrómetros de interiores



1096
Plantillas para afilados



1115
Medidores digitales



1089
Escuadras



1097
Juegos de rotular



1120
Multímetros



1090
Falsas escuadras



1098
Juegos de numeraciones



1091
Escuadra digital

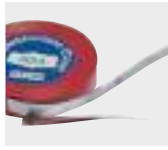

1099
Cintas de espesores



1091
Reglas



1100
Puntas de trazar

MEDICIÓN | 10



Calibre analógico no monoblock con tornillo de fijación



- Acero templado. Cromado mate.
- 4 funciones de medida.
- Tabla de roscas al dorso.

Ref.	Código	Rango de medición	Lectura	Longitud bocas	€ / u.
8001938	17240	0-150mm	0,05 mm. - 1/128"	40 mm	32,35
8001939	17246	0-200mm	0,05 mm. - 1/128"	50 mm	58,62



Calibre analógico no monoblock con pulsador, bloqueo automático



- Acero templado. Cromado mate.
- 4 funciones de medida.
- Tabla de roscas al dorso.

Ref.	Código	Rango de medición	Lectura	Longitud bocas	€ / u.
8001940	17242	0-150mm	0,05 mm. - 1/128"	40 mm	32,35
8001941	17243	0-200mm	0,05 mm. - 1/128"	50 mm	65,43



Calibre analógico monoblock con tornillo de fijación



- Acero Inox. Templado. Cromado mate.
- 4 funciones de medida.
- Tabla de roscas al dorso.
- Fabricado según norma DIN 862.

Ref.	Código	Rango de medición	Lectura	Longitud bocas	€ / u.
8001942	18530	0-150mm	0,05 mm. - 1/128"	40 mm	52,60
8001943	18532	0-200mm	0,05 mm. - 1/128"	50 mm	81,14



Calibre analógico monoblock con pulsador, bloqueo automático



- Acero Inox. Templado. Cromado mate.
- 4 funciones de medida.
- Tabla de roscas al dorso.
- Fabricado según norma DIN 862.

Ref.	Código	Rango de medición	Lectura	Longitud bocas	€ / u.
8001944	18521	0-150mm	0,02 mm. - 1/1000"	40 mm	54,96
8001945	18523	0-200mm	0,02 mm. - 1/1000"	50 mm	83,77



Calibre analógico con pulsador



Ref.	Código	Denominación	Peso kg.	Precisión	Rango de medición mm	€ / u.
8000348	11445800	CL15	0.155	1/0.02mm	0-150	13,78



Calibre analógico con reloj



- Acero Inox. Templado. Cromado mate.
- 4 funciones de medida.
- Tabla de roscas al dorso.
- Fabricado según norma DIN 862.

Ref.	Código	Rango de medición	Lectura	Longitud bocas	Ø Reloj	€ / u.
8001949	18545	0-150mm	0,01 mm.	40 mm	38 mm	112,55



Calibre analógico para zurdos



- Acero Inox. Templado. Cromado mate.
- 4 funciones de medida.
- Tabla de roscas al dorso.
- Fabricado según norma DIN 862.

Ref.	Código	Rango de medición	Lectura	Longitud bocas	Fijación	€ / u.
8001947	18510	0-150mm	0,05 mm. - 1/128"	40 mm	Tornillo de fijación	78,52
8001948	18511	0-150mm	0,05 mm. - 1/128"	40 mm	Pulsador bloqueo auormático	81,14



Calibre digital función ABS con rodillo



- Acero Inox. Templado.
- Con tornillo de fijación.
- 4 funciones de medida.
- Fabricado según norma DIN 862.
- Pantalla de 12 mm.
- Caja metálica
- Sistema Absoluto
- Botones:
 - Encendido / Apagado.
 - mm / pulgadas.
 - "Origen". - "ABS".

Ref.	Código	Rango de medición	Lectura	Longitud bocas	€ / u.
8001952	17266	0-150mm	0,01 mm. / 0,00005"	40 mm	101,75



Calibre digital de fibra de carbono



- Pantalla de 12 mm.
- Fabricado en fibra de carbono.
- Botones:
 - Encendido / Apagado.
 - mm / pulgadas.
 - "Zero".

Ref.	Código	Rango de medición	Lectura	Longitud bocas	€ / u.
8001953	18575	0-150mm	0,1 mm. / 0,005"	40 mm	55,22



Calibre digital con rodillo y protección IP54



- Acero Inox. Templado
- Con tornillo de fijación
- Pantalla 30 x 13 mm.
- Salida de datos RS232
- Botones:
 - Encendido / Apagado.
 - mm / pulgadas.
 - "Zero".



Ref.	Código	Rango de medición	Lectura	Longitud bocas	€ / u.
8001954	18589	0-150mm	0,01 mm. / 0,00005"	40 mm	85,23

Calibre digital standard con / sin rodillo



- Posibilidad de quitar y poner el rodillo de forma sencilla.
- Se suministra con el rodillo colocado.
- Acero Inox. Templado.
- Con tornillo de fijación.
- 4 funciones de medida.
- Fabricado según norma DIN 862.
- Pantalla de 12 mm.
- Botones:
 - Encendido / Apagado.
 - mm / pulgadas.
 - "Zero".



Ref.	Código	Rango de medición	Lectura	Longitud bocas	€ / u.
8001950	17260	0-150mm	0,01 mm. / 0,00005"	40 mm	73,61
8001951	17262	0-200mm	0,01 mm. / 0,00005"	50 mm	133,14

Calibre analógico tipo Tornero



Acero Inoxidable. Cromado mate, templado. Carro monoblock. Con tornillo de fijación. Fabricado según norma DIN 862.

Ref.	Código	Rango de medición	Lectura	Longitud bocas	€ / u.
8001955	17200	0-300mm	0,05 mm. - 1/128"	90 mm	240,79
8001956	17205	0-500mm	0,05 mm. - 1/128"	150 mm	601,98
8001957	17209	0-800mm	0,05 mm. - 1/128"	150 mm	1.177,77



Calibre analógico tipo Tornero. Ajuste fino



Acero Inoxidable. Cromado mate, templado. Carro monoblock. Con tornillo de fijación. Fabricado según norma DIN 862.

Ref.	Código	Rango de medición	Lectura	Longitud bocas	€ / u.
8001959	17184	0-300mm	0,05 mm. - 1/128"	90 mm	277,44
8001960	17188	0-500mm	0,05 mm. - 1/128"	150 mm	667,40
8001961	17191	0-800mm	0,05 mm. - 1/128"	150 mm	1.282,47
8001962	17193	0-1000mm	0,05 mm. - 1/128"	150 mm	1.439,52



Calibre analógico tipo Tornero. Ajuste fino con orejas



Acero Inox. Templado. Con ajuste fino. Escala de lectura grabada con láser. Con tornillo de fijación. Carro con doble guía de latón.

Ref.	Código	Rango de medición	Lectura	Longitud bocas	€/ u.
8001963	17051	0-250mm	0,05 mm. - 1/128"	80 mm	183,23
8001964	17052	0-300mm	0,05 mm. - 1/128"	90 mm	251,06



Calibre digital tipo Tornero. Ajuste fino



Acero Inox. Templado. Con ajuste fino. Escala de lectura grabada con láser. Con tornillo de fijación. Carro con doble guía de latón.

Ref.	Código	Rango de medición	Lectura	Longitud bocas	€/ u.
8001965	17285	0-300mm	0,01 mm. / 0,0005"	150 mm	484,12
8001966	17287	0-500mm	0,01 mm. / 0,0005"	150 mm	532,54
8001967	17291	0-800mm	0,01 mm. / 0,0005"	150 mm	934,97
8001968	17293	0-1000mm	0,01 mm. / 0,0005"	150 mm	1.270,58



Calibre de Profundidad punta plana



Acero Inox. Cromado mate. Con tornillo de fijación. Fabricado según norma DIN 862.

Ref.	Código	Rango de medición	Lectura	Puente	€/ u.
8001969	17022	0-150mm	0,05 mm.	100 mm	72,93
8001970	17026	0-200mm	0,05 mm.	100 mm	74,29
8001971	17034	0-300mm	0,05 mm.	100 mm	104,18



Reloj comparador centesimal



Caja de plástico. Con marcadores de tolerancia. Vástago de amarre de Ø 8 mm. h6.

Ref.	Código	Rango de medición	Lectura	Precision	Ø Esfera	€/ u.
8002008	8500	3 mm.	0,01 mm	17 mm	40 mm	62,94
8002009	8502	10 mm.	0,01 mm	17 mm	58 mm	50,35



Calibrador rápido de exteriores con reloj



Para medición de cañones de armas, tubos y otros canales de difícil medición. Con puntas de contacto redondas. Medición: 0,01 mm.

Ref.	Código	Rango de medición	Lectura	Precision	€/ u.
8002010	8674	0 - 20 mm	0,01 mm	± 0,03 mm	512,24



Calibrador rápido de exteriores digital



Para medición de cañones de armas, tubos y otros canales de difícil medición. Con puntas de contacto redondas. Medición: 0,01 mm.

Ref.	Código	Rango de medición	Lectura	Precisión	€ / u.
8002011	8679	0 - 20 mm	0,01 mm	± 0,03 mm	569,14



Calibrador rápido de interiores con reloj



Para medición de cañones de armas, tubos y otros canales de difícil medición. Con puntas de contacto redondas. Medición: 0,01 mm.

Ref.	Código	Rango de medición	Lectura	Precisión	€ / u.
8002012	8662	5 - 15 mm	0,01 mm	± 0,02 mm	420,66



Calibrador rápido de interiores digital



Para medición de cañones de armas, tubos y otros canales de difícil medición. Con puntas de contacto redondas. Medición: 0,01 mm.

Ref.	Código	Rango de medición	Lectura	Precisión	€ / u.
8002013	8668	5 - 15 mm	0,01 mm	± 0,02 mm	494,90



Micrómetro analógico de exteriores. Tambor de carraca, arco plano



Contactos de metal duro. Casquillo y tambor cromados. Arco de acero cromado. Eje Ø 6,5 mm. Paso de rosca 0,5 mm. Embrague y freno para fijación de lectura. Incluye barra patrón a partir de 25-50. Fabricado según norma DIN 863.

Ref.	Código	Rango de medición	Lectura	Profundidad arco	€ / u.
8001998	8100	0-25 mm	0.01 mm	24 mm	53,16
8001999	8102	25-50 mm	0.01 mm	32 mm	58,49
8002000	8104	50-75 mm	0.01 mm	45 mm	64,43
8002001	8106	75-100 mm	0.01 mm	57 mm	70,80
8002002	8108	100-125 mm	0.01 mm	70 mm	82,08
8002003	8110	125-150 mm	0.01 mm	82 mm	96,76



Micrómetro digital con protección IP 54



Contactos de metal duro. Eje Ø 6,5 mm. Embrague y freno para fijación de lectura. Incluye barra patrón a partir de 25-50. Fabricado según norma DIN 863.

Ref.	Código	Rango de medición	Lectura	Profundidad arco	€ / u.
8002004	8200	0-25 mm	0.001 mm	28 mm	216,24
8002005	8202	25-50 mm	0.001 mm	35 mm	287,31
8002006	8204	50-75 mm	0.001 mm	48 mm	314,68
8002007	8206	75-100 mm	0.001 mm	60 mm	342,03



IP 54



Escuadra biselada



Acero inoxidable templado DIN 875/00.

INOX

Ref. INOX	Código INOX	Dimensiones mm	Sección mm	€/ u.
903701	5054	50 x 40	14 x 4	83,22
903702	5074	75 x 50	16 x 4	92,79
903703	5104	100 x 70	25 x 5	109,86
903704	5154	150 x 100	25 x 6	154,65
903705	5204	200 x 130	30 x 7	203,06
903706	5254	250 x 160	40 x 8	221,12
903707	5304	300 x 200	40 x 8	299,99



Escuadra de precisión con sombrero de acero inoxidable DIN 1



Precisión: Grado 1. Acero inoxidable. Fabricada bajo norma DIN 875/1. Control unitario de todas las piezas

INOX

Ref. INOX	Código INOX	Dimensiones	Sección aproximada en mm.	Tolerancia de perpendicularidad (micras)	€/ u.
8001979	11807	75 x 50mm	16 x 7	14	54,08
8001980	11810	100 x 70mm	16 x 7	15	54,08
8001981	11815	150 x 100mm	20 x 7	18	66,76
8001982	11820	200 x 130mm	25 x 7	20	86,49
8001983	11825	250 x 165mm	30 x 8	23	110,98
8001984	11830	300 x 200mm	30 x 8	25	155,66



Escuadra de precisión lisa de acero inoxidable DIN 0



Precisión: Grado 0. Acero inoxidable Templadas. Fabricada bajo norma DIN 875/0. Control unitario de todas las piezas

INOX

Ref. INOX	Código INOX	Dimensiones	Sección aproximada en mm.	Tolerancia de perpendicularidad (micras)	€/ u.
8001985	1007	75 x 50mm	15 x 5	7	64,36
8001986	1010	100 x 70mm	20 x 5	7	72,50
8001987	1015	150 x 100mm	25 x 5	8	97,98
8001988	1020	200 x 130mm	30 x 6	9	124,07
8001989	1025	250 x 165mm	35 x 7	10	171,26
8001990	1030	300 x 200mm	40 x 8	11	225,36



Escuadra de precisión con sombrero de acero inoxidable DIN 0



Precisión: Grado 0. Acero inoxidable Templadas. Fabricada bajo norma DIN 875/0. Control unitario de todas las piezas

INOX

Ref. INOX	Código INOX	Dimensiones	Sección aproximada en mm.	Tolerancia de perpendicularidad (micras)	€/ u.
8001992	10007	75 x 50mm	15 x 5	7	80,82
8001993	10010	100 x 70mm	20 x 5	7	92,66
8001994	10015	150 x 100mm	25 x 5	8	132,01
8001995	10020	200 x 130mm	30 x 6	9	183,25
8001996	10025	250 x 165mm	35 x 7	10	253,98
8001997	10030	300 x 200mm	40 x 8	11	312,35



Escuadra de precisión lisa de acero inoxidable DIN 1



Precisión: Grado 1. Acero inoxidable. Fabricada bajo norma DIN 875/1. Control unitario de todas las piezas



Ref. INOX	Código INOX	Dimensiones	Sección aproximada en mm.	Tolerancia de perpendicularidad (micras)	€ / u.
8001973	2807	75 x 50mm	16 x 7	14	35,05
8001974	2810	100 x 70mm	16 x 7	15	42,68
8001975	2815	150 x 100mm	20 x 7	18	49,03
8001976	2820	200 x 130mm	25 x 7	20	57,04
8001977	2825	250 x 165mm	30 x 8	23	91,15
8001978	2830	300 x 200mm	30 x 8	25	119,16

Escuadra lisa. DIN 875



Acero al carbono DIN 875/1.



Ref.	Código	€ / u.	Ref.	Código	€ / u.	Dimensiones mm	Sección mm
903800	1074	19,86	903900	3074	17,45	75 x 50	16 x 7
903801	1104	19,86	903901	3104	17,45	100 x 70	16 x 7
903802	1154	22,12	903902	3154	17,45	150 x 100	20 x 7
903803	1204	27,26	903903	3204	20,92	200 x 130	25 x 7
903804	1254	41,30	903904	3254	28,82	250 x 160	30 x 8
903805	1304	46,46	903905	3304	32,49	300 x 180	30 x 8
903806	1404	87,39	903906	3404	76,04	400 x 265	40 x 10
903807	1504	122,52	903907	3504	94,52	500 x 330	40 x 10
903808	1754	249,24	903908	3754	218,25	750 x 500	50 x 10
903809	1994	396,91	903909	3994	293,83	1.000 x 500	50 x 10

Escuadra de sombrero. DIN 875



Acero al carbono DIN 875.



Ref.	Código	€ / u.	Ref.	Código	€ / u.	Dimensiones mm	Sección mm
904100	12074	34,26	904000	10074	37,40	75 x 50	16 x 7
904101	12104	34,26	904001	10104	37,40	100 x 70	16 x 7
904102	12154	34,26	904002	10154	37,69	150 x 100	20 x 7
904103	12204	34,80	904003	10204	42,87	200 x 130	25 x 7
904104	12254	43,24	904004	10254	55,94	250 x 160	30 x 8
904105	12304	48,82	904005	10304	65,24	300 x 180	30 x 8
904106	12404	106,59	904006	10404	134,69	400 x 265	40 x 10
904107	12504	129,65	904007	10504	188,59	500 x 330	40 x 10
904108	12754	338,02	904008	10754	417,28	750 x 500	50 x 10
904109	12994	379,99	904009	10994	557,97	1.000 x 500	50 x 10

Falsa escuadra de acero cromado mate, graduada



Grados indicados: 15°, 30°, 45°, 60°, 75°, 90° y 120°.



Ref.	Código	Longitud Regla mm	Sección regla mm	€ / u.
903815	16002	150	22 x 3	21,14
903816	16004	200	22 x 3	23,51
903817	16008	300	25 x 3	31,31

Escuadra digital



Escuadras de aluminio digital con nivel para medición de ángulos mediante display digital. Lectura en décimas de grado.

Ref.	Capacidad	Longitud mm	Precisión	€/ u.
904500	0-180°	350	0,15°	501,62
904501	0-225°	400	0,5°	109,46



Falsa escuadra digital con nivel



Lectura: 0,1°. Cuerpo de aluminio. Con 2 folios: horizontal y vertical. Apertura máxima: 225°.

Ref.	Código	Dimensiones mm	Lectura	€/ u.
6004005	16052	400	0,1°	71,92



Regla rígida de precisión



DIN 874/II. Para control de planitud. Para trabajos de precisión

Ref. INOX	Código INOX	Dimensiones mm	€/ u.
904603	34905	500 x 30 x 6	143,15
904604	34910	1.000 x 40 x 8	366,45
904605	34915	1.500 x 50 x 10	1.120,00
904606	34920	2.000 x 60 x 12	1.310,05

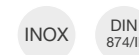

Regla rígida de precisión milimetrada DIN 866/A



Escala en mm. Ancho de los trazos: de 70 a 100 micras. Comienzo y fin de la escala a 5 mm de cada borde. Fabricado según norma DIN 866/A

Ref.	Código	Longitud	Sección aproximada en mm.	Tolerancia (micras)	€/ u.
8002026	35005	500 mm	30 x 6	40	83,48
8002027	35010	1000 mm	40 x 8	40	175,70
8002028	35020	2000 mm	50 x 10	60	470,40



Regla rígida de precisión para control de planitudes DIN 874/2



Ref.	Código	Longitud	Sección aproximada en mm.	Tolerancia (micras)	€/ u.
8002029	34320	2000 mm	60 x 12	58	461,65
8002030	34330	3000 mm	80 x 15	83	1.536,50



Regla rígida milimetrada DIN 866/B



DIN 866/B. Escala en mm. Ancho de los trazos: de 100 a 150 micras. Comienzo de la escala en el borde izquierdo. Fin de la escala a 10 mm. del borde derecho.

DIN 866/B



Ref.	Código	Dimensiones mm	Material	€/ u.
904702	35115	1.500 x 30 x 6	Acero al carbono	171,57
904704	35130	3.000 x 40 x 8	Acero al carbono	655,20
904705	35305	500 x 25 x 5	Acero inox	101,33
904706	35310	1.000 x 30 x 6	Acero inox	217,35

Ref.	Código	Dimensiones mm	Material	€/ u.
904707	35315	1.500 x 30 x 6	Acero inox	375,20
904708	35320	2.000 x 40 x 8	Acero inox	667,10
904709	35330	3.000 x 40 x 8	Acero inox	1.220,80

Regla flexible inoxidable



Hasta 500 mm inclusive grabadas por las dos caras. Grabadas en profundidad. En mm. y 1/2 mm.

INOX



Ref. INOX	Código INOX	Dimensiones mm	€/ u.
904800	31014	100 x 13 x 0,5	6,33
904801	31024	150 x 13 x 0,5	2,40
904802	31034	200 x 13 x 0,5	3,73
904803	31044	250 x 13 x 0,5	6,55
904804	31054	300 x 13 x 0,5	5,59

Ref. INOX	Código INOX	Dimensiones mm	€/ u.
904805	31064	500 x 20 x 0,5	8,22
904806	31074	1.000 x 25 x 0,5	19,65
904807	31084	1.500 x 25 x 0,5	78,93
904808	31094	2.000 x 25 x 0,5	105,23

Cartabón vaciado con baño inox.



Control y trazado de ángulos de 45° y 90°



Ref.	Código	€/ u.	Ref.	Código	€/ u.	Dimensiones mm
903820	14124	18,89	903825	15124	28,01	125 x 125
903821	14154	22,58	903826	15154	32,63	150 x 150
903822	14204	31,15	903827	15204	38,56	200 x 200
			903828	15254	56,05	250 x 250

Transportador de ángulos visor cuadrado



Acero especial, cromado mate. Visor de puntero. Rango de medición de 0 a 180°. Con tornillo de fijación.



Ref.	Código	Longitud mm	Ø	€/ u.
905200	17116	160	130	33,06
905201	17118	200	160	35,03
905202	17120	300	210	43,63
905203	17122	380	260	70,06



Transportador de ángulos con corredera



- Acero especial. Cromado mate.
- Rango de medición de 10 - 170°.
- Hoja con corredera ajustable.
- Con tornillo de fijación en la parte superior.
- Parte trasera plana.

Ref.	Código	Longitud Regla (mm)	Ø Arco (mm.)	Peso kg	€/ u.
8002014	17150	150	100	0,115	71,73
8002015	17151	300	150	0,25	86,21
8002016	17152	400	200	0,51	102,11
8002017	17153	500	250	0,99	151,35
8002018	17154	600	300	1,32	182,67



Transportador de ángulos con visor de puntero



- Acero especial, cromado mate.
- Visor de puntero.
- Rango de medición: de 0 a 180°.
- Con tornillo de fijación.

Ref.	Código	Longitud Regla (mm)	Ø Arco (mm.)	Peso kg	€/ u.
8002019	17140	120	80	0,1	39,18
8002020	17141	150	120	0,165	45,20
8002021	17142	200	150	0,3	54,82
8002022	17143	300	200	0,525	69,31
8002023	17145	600	300	1,52	199,60



Goniómetro universal de lectura directa



Con ajuste fino y lupa. Lectura sin paralaje. Escala cromo mate. Lectura directa 1/12° = 5'. Rango de medición: 4 x 90°. Con escuadra móvil para medición de ángulos pequeños.

Ref.	Código	Longitud Hoja (mm.)	Peso kg	€/ u.
8002024	17160	150	0,575	215,48
8002025	17161	200	0,85	219,58



Compás de muelles de puntas



Compás de muelle DIN 6487. Tuerca de desplazamiento rápido. Puntas templadas. Apertura máxima aproximada = longitud.

Ref.	Código	Longitud mm	€/ u.
905400	28670	100	13,75
905401	28671	150	15,10
905402	28672	200	17,85
905403	28673	250	20,59
905404	28674	300	26,11
905405	28675	400	37,26
905406	28676	500	44,78
905407	28677	600	65,80



Compás de muelles de puntas intercambiables



Compás de muelle DIN 6487. Tuerca de desplazamiento rápido. Puntas Intercambiables. Apertura máxima aproximada = longitud.

Ref.	Código	A mm	Longitud mm	€ / u.
905300	19013	60	100	15,17
905301	19014	85	125	15,17
905302	19024	110	150	16,53
905303	19034	160	200	20,21
905304	19044	210	250	23,29
905305	19054	260	300	28,09
905307	19065	-	2 puntas widia 30 x ø2	7,02



Compás de muelles para interiores



Compás de muelle DIN 6487. Tuerca de desplazamiento rápido. Puntas Intercambiables. Apertura máxima aproximada = longitud.

Ref.	Código	Longitud mm	€ / u.
905500	28690	100	13,75
905501	28691	150	15,10
905502	28692	200	17,85
905503	28693	250	20,59
905504	28694	300	26,11
905505	28695	400	37,07
905506	28696	500	43,93
905507	28697	600	65,49



Compás de patas cuadradas con fijador



Sistema de tornillo y tuerca. Permite un apriete preciso, incluso después de años de uso. Apertura máxima aproximada (recomendada) = longitud.

Ref.	Código	Longitud (mm)	Tipo de Punta	€ / u.
8002045	28154	150	Widia	23,02
8002046	28204	200	Widia	24,00
8002047	28254	250	Acero	43,86
8002048	28304	300	Acero	45,79



Compás de patas cuadradas sin fijador



Sistema de tornillo y tuerca. Permite un apriete preciso, incluso después de años de uso. Apertura máxima aproximada (recomendada) = longitud.

Ref.	Código	Longitud (mm)	Tipo de Punta	€ / u.
8002049	27154	150	Widia	17,86
8002050	27204	200	Widia	18,83
8002051	27254	250	Acero	35,35
8002052	27304	300	Acero	38,08



Compás plano zincado de puntas



Unión remachada. Puntas templadas. Apertura máxima aproximada (recomendada) = longitud.

Ref.	Código	Longitud (mm)	€ / u.
8002031	25154	150	11,54
8002032	25204	200	12,75
8002033	25254	250	15,18
8002034	25304	300	17,26



Compás plano zincado para exteriores



Unión remachada. Apertura máxima aproximada (recomendada) = longitud.

Ref.	Código	Longitud (mm)	€ / u.
8002035	23104	100	10,77
8002036	23154	150	11,54
8002037	23204	200	12,75
8002038	23254	250	15,18
8002039	23304	300	17,26



Compás plano zincado para interiores



Unión remachada. Apertura máxima aproximada (recomendada) = longitud.

Ref.	Código	Longitud (mm)	€ / u.
8002040	24104	100	10,77
8002041	24154	150	11,54
8002042	24204	200	12,75
8002043	24254	250	15,18
8002044	24304	300	17,26



Compás de muelles para exteriores



Compás de muelle DIN 6487. Tuerca de desplazamiento rápido. Puntas Inter-cambiables. Apertura máxima aproximada = longitud.

Ref.	Código	Longitud mm	€ / u.
905600	28680	100	13,75
905601	28681	150	15,10
905602	28682	200	17,85
905603	28683	250	20,59
905604	28684	300	26,11
905605	28685	400	37,07
905606	28686	500	43,93
905607	28687	600	65,49



Juego de galgas de espesores



Hojas cónicas

Ref.	Código	Espesor mm	Material	N° láminas	€/ u.
905700	35400	0,03 - 0,10	Acero al carbono	8	6,90
905701	35409	0,05 - 1	Acero al carbono	13	9,32
905702	35411	0,05 - 1	Acero al carbono	20	13,11
905703	35417	0,05 - 1	Inox	13	23,29
905704	35419	0,05 - 1	Inox	20	35,35



Juego de galgas para costuras de soldadura



Para ángulos rectos. Escala de medición de 3 a 12 mm.

Ref.	Código	Costura mm	N° láminas	Para	€/ u.
905750	36140	3-12	12	Ángulos rectos	34,18



Calibre para costuras de soldadura



Acero Inox. Cromado mate. Con tornillo de fijación. Con ángulos de 60°, 70°, 80° y 90°.

Ref.	Código	Costura mm	Lectura	€/ u.
905850	36142	0-20	0,1 mm. en ambos sentidos	52,47



Plantilla para radios cóncavos y convexos



En acero al carbono e inoxidable. Grabación indeleble de la medida en cada galga. Para comprobación de radios exteriores e interiores

Ref.	Código	Material	N° hojas	Radios mm	€/ u.
905800	35490	Acero carbono	17	1 a 7	19,13
905801	35491	Acero carbono	16	7,5 a 15	25,48
905802	35492	Acero carbono	15	15,5 a 25	25,48
905900	35570	INOX	17	1 a 7	37,43
905901	35572	INOX	16	7,5 a 15	41,16
905902	35574	INOX	15	15,5 a 25	41,16



Plantilla para afilado de herramientas



Graduado en mm. Para roscas 60° Métrica

Ref.	Código	Plantilla	€/ u.
906100	35493	Roscas 60° Métrica	5,89
906101	35494	Roscas 55° Whitworth	5,89
906102	35495	Rosca trapecial	8,21
906103	35501	Roscas plana/punta	6,55
906104	35496	Brocas	3,73
906105	35497	Universal	12,67



35493



35495



35501

Juego de galgas de espesores



• Hojas rectangulares 300 x 13 mm • Acero al Carbono



Ref.	Código	N° de láminas	Espesores en mm.	€/ u.
8002053	35432	13	0,05 - 0,10 - 0,15 - 0,20 - 0,25 - 0,30 - 0,40 - 0,50 - 0,60 - 0,70 - 0,80 - 0,90 - 1,00	34,23
8002054	35434	20	0,05 - 0,10 - 0,15 - 0,20 - 0,25 - 0,30 - 0,35 - 0,40 - 0,45 - 0,50 - 0,55 - 0,60 - 0,65 - 0,70 - 0,75 - 0,80 - 0,85 - 0,90 - 0,95 - 1,00	50,28

Juego de galgas para toberas



• Permite medir y verificar diámetro de agujeros pequeños y toberas



Ref.	Código	N° de espigas	Ø espigas en mm	€/ u.
8002055	35477	20	0,45 - 0,50 - 0,55 - 0,60 - 0,65 - 0,70 - 0,75 - 0,80 - 0,85 - 0,90 - 0,95 - 1,00 - 1,05 - 1,10 - 1,15 - 1,20 - 1,25 - 1,30 - 1,40 - 1,50	25,78
8002056	35478	16	1,50 - 1,60 - 1,70 - 1,80 - 1,90 - 2,00 - 2,10 - 2,20 - 2,30 - 2,40 - 2,50 - 2,60 - 2,70 - 2,80 - 2,90 - 3,00	25,78

Estuche con 100 caracteres intercambiables de golpe



Dureza aproximada en la punta: 60 HRC. Caracteres sueltos: Consultar.

Ref.	Código	Altura del carácter mm	Caracteres en portacaracteres	Tipo de mango	€/ u.
906550	57544	3	13	Manual	707,42
906551	57546	4	10	Manual	707,42
906552	57548	5	8	Manual	707,42
906553	57564	3	13	Prensa	764,01
906554	57566	4	10	Prensa	764,01
906555	57568	5	8	Prensa	764,01



Juego de rotular. Abecedarios



Estricta tolerancia de espesores. Alta resistencia a la tracción

Ref.	Código	Altura letra mm	Dimensiones de la chapa mm	Grs	€/ u.
957108	57108 D	30	62x49	42	25,36
957112	57112 D	40	71x57	54	30,25
957116	57116 D	50	81x69	86	32,57
957120	57120 D	60	94x79	104	35,62
957126	57126 D	80	119x100	130	39,58
957130	57130 D	100	139x111	170	52,61





Juego de abecedarios de golpe normales e invertidos

Fabricado según norma DIN 1451. Dureza en la punta 60 HRC.

Ref.	Código	€ / u.	Ref.	Código	€ / u.	Altura letra mm	Tamaño punzón
906200	57040	47,59				1	64 x 6
906201	57041	29,90	906300	57482	51,69	2	64 x 6
906202	57042	30,87	906301	57484	54,22	3	64 x 6
906203	57043	33,04	906302	57486	57,13	4	64 x 7
906204	57044	35,82	906303	57488	61,58	5	64 x 8
906205	57045	40,42	906304	57490	69,27	6	74 x 9
906206	57046	55,79				7	77 x 11
906207	57047	55,79	906305	57492	95,67	8	77 x 11
906209	57049	72,73	906306	57493	127,11	10	80 x 12
906210	57051	85,51	906307	57494	149,95	12	80 x 14
906211	57053	140,81				15	83 x 16
906213	57056	485,97				20	100 x [24 x 15]



Juego de numeraciones de golpe normales e invertidos

Fabricado según norma DIN 1451. Dureza en la punta 60 HRC.

Ref.	Código	€ / u.	Ref.	Código	€ / u.	Altura letra mm	Tamaño punzón
906400	57020	15,90				1	64 x 6
906401	57021	9,98	906500	57462	17,23	2	64 x 6
906402	57022	10,50	906501	57464	18,12	3	64 x 6
906403	57023	11,03	906502	57466	19,05	4	64 x 7
906404	57024	12,13	906503	57468	20,59	5	64 x 8
906405	57025	13,51	906504	57470	23,13	6	74 x 9
906406	57026	18,61				7	77 x 11
906407	57027	18,61	906505	57472	31,90	8	77 x 11
906409	57029	24,26	906506	57473	42,35	10	80 x 12
906410	57031	28,50	906507	57474	49,96	12	80 x 14
906411	57033	49,12				15	83 x 16
906413	57036	205,75				20	100 x [24 x 15]



Juego de rotular. Numeraciones

Estricta tolerancia de espesores. Alta resistencia a la tracción

Ref.	Código	Altura letra mm	Dimensiones de la chapa mm	Grs	€ / u.
957208	57208 D	30	62x49	15	11,03
957212	57212 D	40	71x57	20	13,22
957216	57216 D	50	81x69	42	14,16
957220	57220 D	60	94x79	46	15,55
957226	57226 D	80	119x100	55	17,07
957230	57230 D	100	139x111	70	20,74



Cinta de espesores calibrada en rollo de 1 m x 12,7 mm



Estricta tolerancia de espesores. Alta resistencia a la tracción



Ref.	Código	€/ u.	Ref.	Código	€/ u.	Espesor mm
906800	37000	37,46				0,005
906801	37001	32,99	906900	35450	111,38	0,01
906802	37002	21,12	906901	35451	63,42	0,02
906803	37004	8,84	906902	35452	21,84	0,03
906804	37005	8,38	906903	35453	21,40	0,04
906805	37006	7,95	906904	35454	16,14	0,05
906806	37007	6,77	906905	35455	17,22	0,06
906807	37008	6,77	906906	35456	16,46	0,07
906808	37010	8,08	906907	35457	16,46	0,08
906809	37011	6,77	906908	35458	16,46	0,09
906810	37012	6,77				0,1
			906909	35459	15,16	0,10
906811	37013	6,77	906915	3546001	19,86	0,12
906812	37014	6,77	906916	3546002	15,27	0,15
906813	37015	7,20				0,18
906814	37016	6,77	906910	35461	16,14	0,20
906815	37017	6,77	906914	35462	15,27	0,25
906816	37018	6,77	906911	35463	16,14	0,30
906817	37019	7,10				0,35
906818	37020	7,20	906912	35465	16,80	0,40
906819	37021	7,20				0,45

Ref.	Código	€/ u.	Ref.	Código	€/ u.	Espesor mm
906820	37022	7,20	906913	35467	17,24	0,50
906821	37023	10,15				0,55
907100	37024	10,15	907200	35469	21,09	0,60
907101	37025	10,15				0,65
907102	37026	10,15	907201	35471	21,09	0,70
907103	37027	10,55				0,75
907104	37028	10,55	907202	35472	21,09	0,80
907105	37029	10,55				0,85
907106	37030	10,55	907203	35474	21,61	0,90
907107	37031	10,55				0,95
907108	37032	10,55	907204	35476	21,61	1,00
907109	37033	12,32				1,10
907110	37034	12,32				1,20
907111	37035	12,32				1,30
907112	37036	12,32				1,40
907113	37037	12,51				1,50
907114	37038	19,70				1,60
907115	37039	14,91				1,70
907116	37040	15,93				1,80
907117	37041	15,93				1,90
907118	37042	15,93				2,00

Cinta de espesores calibrada en rollo de 5 m x 150 mm



Estricta tolerancia de espesores. Alta resistencia a la tracción



Ref.	Código	Espesor mm	Resistencia N/mm2	Tolerancia mm	Material	€/ u.
906950	37653	0,025	1.850 - 2.100	0,002	INOX	254,42
906951	37656	0,05	1.600 - 1.800	0,003	INOX	200,90
906952	37659	0,075	1.600 - 1.800	0,004	INOX	192,63
906953	37662	0,10	1.600 - 1.800	0,004	INOX	184,83
906954	37664	0,15	1.600 - 1.800	0,005	INOX	187,65
906955	37666	0,20	1.600 - 1.800	0,006	INOX	232,02
906956	37667	0,25	1.600 - 1.800	0,007	INOX	241,46
906957	37668	0,30	1.600 - 1.800	0,007	INOX	231,50
906958	37670	0,40	1.600 - 1.800	0,009	INOX	269,23
906959	37672	0,50	1.600 - 1.800	0,010	INOX	291,60
906960	37674	0,60	1.600 - 1.800	0,010	INOX	397,71
906961	37676	0,70	1.600 - 1.800	0,012	INOX	445,63
906962	37678	0,80	1.600 - 1.800	0,013	INOX	494,33

Ref.	Código	Espesor mm	Resistencia N/mm2	Tolerancia mm	Material	€/ u.
906963	37680	0,90	1.600 - 1.800	0,013	INOX	570,80
906964	37682	1,00	1.600 - 1.800	0,013	INOX	594,01
906965	37703	0,025	540 - 610	0,002	LATÓN	109,28
906966	37706	0,05	540 - 610	0,003	LATÓN	116,10
906967	37709	0,075	540 - 610	0,004	LATÓN	134,88
906968	37712	0,10	540 - 610	0,004	LATÓN	140,71
906969	37714	0,15	450 - 600	0,005	LATÓN	169,66
906970	37716	0,20	450 - 600	0,006	LATÓN	195,06
906971	37717	0,25	450 - 600	0,007	LATÓN	221,94
906972	37718	0,30	450 - 600	0,007	LATÓN	220,66
906973	37720	0,40	450 - 600	0,009	LATÓN	275,63
906974	37722	0,50	450 - 600	0,010	LATÓN	325,99

Cinta de espesores calibrada en rollos de 5 m x 25 mm



Estricta tolerancia de espesores. Alta resistencia a la tracción



Ref.	Código	Espesor mm	Resistencia N/mm ²	Tolerancia mm	Material	€ / u.
907250	37501	0,01	2.000 - 2.200	0,002	INOX	156,53
907251	37502	0,02	1.850 - 2.100	0,002	INOX	96,32
907252	37504	0,03	2.000 - 2.200	0,002	ACERO AL CARBONO	62,50
907253	37505	0,04	2.000 - 2.200	0,003	ACERO AL CARBONO	61,99
907254	37506	0,05	2.000 - 2.200	0,003	ACERO AL CARBONO	53,72
907255	37507	0,06	2.000 - 2.200	0,003	ACERO AL CARBONO	42,59
907256	37508	0,07	2.000 - 2.200	0,004	ACERO AL CARBONO	42,59
907257	37510	0,08	2.000 - 2.200	0,004	ACERO AL CARBONO	42,59
907258	37511	0,09	2.000 - 2.200	0,004	ACERO AL CARBONO	42,59
907259	37512	0,10	2.000 - 2.200	0,004	ACERO AL CARBONO	42,59
907260	37514	0,15	2.000 - 2.200	0,005	ACERO AL CARBONO	43,89

Ref.	Código	Espesor mm	Resistencia N/mm ²	Tolerancia mm	Material	€ / u.
907261	37516	0,20	1.800 - 2.000	0,006	ACERO AL CARBONO	43,89
907262	37517	0,25	1.800 - 2.000	0,007	ACERO AL CARBONO	44,69
907263	37518	0,30	1.800 - 2.000	0,007	ACERO AL CARBONO	44,17
907264	37520	0,40	1.600 - 1.800	0,009	ACERO AL CARBONO	51,31
907265	37522	0,50	1.600 - 1.800	0,010	ACERO AL CARBONO	53,74
907266	37524	0,60	1.600 - 1.800	0,010	ACERO AL CARBONO	69,99
907267	37526	0,70	1.400 - 1.600	0,012	ACERO AL CARBONO	75,69
907268	37528	0,80	1.400 - 1.600	0,013	ACERO AL CARBONO	77,99
907269	37530	0,90	1.400 - 1.600	0,013	ACERO AL CARBONO	77,99
907270	37532	1,00	1.400 - 1.600	0,013	ACERO AL CARBONO	77,23

Cinta de espesores calibrada de acero en rollo de 5 m x 50 mm



Estricta tolerancia de espesores. Alta resistencia a la tracción



Ref.	Código	Espesor mm	Resistencia N/mm ²	Tolerancia mm	Material	€ / u.
907150	37551	0,01	2.000 - 2.200	0,002	INOX	201,53
907151	37552	0,02	1.850 - 2.100	0,002	INOX	113,78
907152	37554	0,03	2.000 - 2.200	0,002	ACERO AL CARBONO	83,46
907153	37555	0,04	2.000 - 2.200	0,003	ACERO AL CARBONO	82,03
907154	37556	0,05	2.000 - 2.200	0,003	ACERO AL CARBONO	80,49
907155	37557	0,06	2.000 - 2.200	0,003	ACERO AL CARBONO	59,96
907156	37558	0,07	2.000 - 2.200	0,004	ACERO AL CARBONO	59,96
907157	37560	0,08	2.000 - 2.200	0,004	ACERO AL CARBONO	59,96
907158	37561	0,09	2.000 - 2.200	0,004	ACERO AL CARBONO	59,96
907159	37562	0,10	2.000 - 2.200	0,004	ACERO AL CARBONO	59,52
907160	37563	0,12	2.000 - 2.200	0,004	ACERO AL CARBONO	59,52
907161	37564	0,15	2.000 - 2.200	0,005	ACERO AL CARBONO	59,52
907162	37565	0,18	2.000 - 2.200	0,005	ACERO AL CARBONO	59,52

Ref.	Código	Espesor mm	Resistencia N/mm ²	Tolerancia mm	Material	€ / u.
907163	37566	0,20	1.800 - 2.000	0,006	ACERO AL CARBONO	58,95
907164	37567	0,25	1.800 - 2.000	0,007	ACERO AL CARBONO	58,95
907165	37568	0,30	1.800 - 2.000	0,007	ACERO AL CARBONO	58,95
907166	37569	0,35	1.800 - 2.000	0,008	ACERO AL CARBONO	68,17
907167	37570	0,40	1.600 - 1.800	0,009	ACERO AL CARBONO	66,44
907168	37571	0,45	1.600 - 1.800	0,009	ACERO AL CARBONO	74,10
907169	37572	0,50	1.600 - 1.800	0,010	ACERO AL CARBONO	68,79
907170	37574	0,60	1.600 - 1.800	0,010	ACERO AL CARBONO	103,57
907171	37576	0,70	1.400 - 1.600	0,012	ACERO AL CARBONO	103,57
907172	37578	0,80	1.400 - 1.600	0,013	ACERO AL CARBONO	104,53
907173	37580	0,90	1.400 - 1.600	0,013	ACERO AL CARBONO	104,53
907174	37582	1,00	1.400 - 1.600	0,013	ACERO AL CARBONO	106,58

Punta de trazar



Punta de metal duro. Cuerpo metálico hexagonal. Con clip de sujeción. Para trazar hierro, azulejos, vidrio, piedra, etc.

Ref.	Código	Descripción	€ / u.
907300	44112	Punta de trazar widia de 145 mm	3,83
907301	44024	Aguja de trazar de cromo vanadio con mango de acetato de Ø4 x 225 mm	4,19
907302	44014	Aguja de trazar acodada y moleteada Ø 4 x 190 mm	2,24



Nivel perfil de aluminio



Sección de 48 x 22 x 1,5 mm, el modelo normal.
Tiene 2 burbujas antichoque y el magnético 3.
Precisión 0,5 mm/m en posición normal.
Hasta 100 cm, milimetrados.



Ref. Normal	Código Normal	€ / u.	Ref. Magnético	Código Magnético	€ / u.	Longitud cm
			907600	53630	20,36	30
907700	53840	39,52	907601	53640	21,97	40
907701	53850	42,90	907602	53650	23,99	50
907702	53860	45,40	907603	53660	25,65	60
907703	53880	49,73	907604	53680	29,49	80

Ref. Normal	Código Normal	€ / u.	Ref. Magnético	Código Magnético	€ / u.	Longitud cm
907704	53895	59,72	907605	53695	33,06	100
907705	53896	65,02	907606	53696	38,26	120
907706	53897	85,01	907607	53697	45,68	150
907707	53898	85,47	907608	53698	52,13	180
907708	53899	89,12	907609	53699	57,83	200

50107 - Nivel tubular extra



Perfil extra ancho con asas reforzadas de gran comodidad. Tres fiolas verticales y horizontales.



Ref.	Código	Longitud mm	€ / u.
900023	50107-40	400	31,24
900024	50107-60	600	40,78

Ref.	Código	Longitud mm	€ / u.
900025	50107-80	800	44,31
900026	50107-100	1000	49,94

50109 - Nivel torpedo magnético



Ranura en V para fácil lectura en tuberías y similares. Precisión 1 mm/m.

Ref.	Código	Longitud mm	€ / u.
900028	50109-9	230	8,09



50101 - Nivel tubular



Alta precisión en la nivelación 0,5 mm/m. Fiolas resistentes al impacto y estables frente a los rayos ultravioletas. Garantía de 15 años. Superficies de trabajo mecanizadas para mayor precisión y uso por ambos lados.

• Perfil tubular con doble nervadura para garantizar la máxima resistencia. Topes antichoque monomateriales (50101) o bimateriales (50107). Usos: Para trabajos de nivelación.



Ref.	Código	Longitud mm	€ / u.
900010	50101-30	300	17,88
900011	50101-40	400	19,61
900012	50101-50	500	20,86

Ref.	Código	Longitud mm	€ / u.
900013	50101-60	600	22,63
900014	50101-80	800	25,43
900015	50101-100	1.000	28,99

Nivel digital magnético



- Pantalla LCD con 45° de inclinación y retroiluminación.
- Lectura 180° - visor rotante.
- Precisión digital: 0,1° en nivel y en plomo. 0,2° otros ángulos.
- Función HOLD.
- Función de modo: grado, porcentaje y pendiente.
- Función recuperación de memoria: 9 mediciones.
- Zumbador -Pitido en 0°, 45° y 90°.
- Función recalibración "Falso cero".
- Batería de 9 V (no incluida) e indicador de batería.

- Impermeable y resistente al polvo.
- Botones de silicona para uso fácil con guantes.
- Tapas amortiguadoras de golpes en los extremos.
- Embalaje en display para colgar.
- Modelo 60 cm:
 - Bases MÁGNETICAS rectificadas con imanes de NEODIMIO de gran fuerza.
 - Fiolas de acrílico sólido y visor frontal.
 - Asa para agarre ergonómico.

Ref.	Código	Longitud cm	N° de fiolas	€ / u.
8002057	53198	25	0	82,88
8002058	53200	60	2	109,00



50107M - Nivel tubular extra magnético



Con imanes de neodimio ultra potentes.

Ref.	Código	Longitud mm	€ / u.
900027	50107M-60	600	55,08



Nivel Pro800



Precisión: 0,5 mm/m. Su forma proporciona una óptima relación resistencia / peso. Perfil duradero de dos cámaras con extremos anti-choque. Sección: 60 x 22 x 2,2 mm. Burbujas anti-choque especialmente diseñadas para la serie PRO800 ENDURANCE PLUS. Burbuja y lente más grandes con mayor capacidad de aumento. Sistema ERS+ (sistema de lectura fácil plus) con doble resistencia a los rayos UV. Asas de goma ergonómicas para mejor agarre. Superficie rectificada (garantiza un excelente contacto con la superficie y una precisión perfecta). A partir de 60 cm, equipados con 2 burbujas verticales.



Ref.	Código	Longitud cm	€ / u.
21006017	53104	40	25,05
21006018	53105	50	26,99
21006019	53106	60	31,85
21006020	53108	80	36,44
21006021	53110	100	40,92

Ref.	Código	Longitud cm	€ / u.
21006022	53112	120	45,99
21006023	53115	150	53,36
21006024	53118	180	59,59
21006025	53120	200	66,86

Nivel Pro800 magnético



Precisión: 0,5 mm/m. Su forma proporciona una óptima relación resistencia / peso. Perfil duradero de dos cámaras con extremos anti-choque. Sección: 60 x 22 x 2,2 mm. Burbujas anti-choque especialmente diseñadas para la serie PRO800 ENDURANCE PLUS. Burbuja y lente más grandes con mayor capacidad de aumento. Sistema ERS+ [sistema de lectura fácil plus] con doble resistencia a los rayos UV. Asas de goma ergonómicas para mejor agarre. Superficie rectificadora [garantiza un excelente contacto con la superficie y una precisión perfecta]. A partir de 60 cm, equipados con 2 burbujas verticales. Imanes de neodimio ultra-potentes



Ref.	Código	Longitud cm	€/ u.
21006026	53134	40	36,37
21006027	53135	50	40,21
21006028	53136	60	42,56
21006029	53138	80	52,42
21006030	53140	100	64,19

Ref.	Código	Longitud cm	€/ u.
21006031	53142	120	66,61
21006032	53145	150	72,61
21006033	53148	180	78,07
21006034	53150	200	82,36

Nivel perfil de aluminio modelo "SUPER-PRO".



Sección de 60 x 25 x 2 mm.
 Precisión 0,5 mm/m en posición normal.
 Base rectificadora.
 Con visor frontal.
 3 burbujas anti choque.
 Con asas de goma para un mejor agarre.



Ref. Normal	Código Normal	€/ u.	Ref. Magnético	Código Magnético	€/ u.	Longitud cm	Nº asas
907800	53304	31,48	907900	53324	43,75	40	0
907801	53305	38,53	907901	53325	55,02	50	1
907802	53306	44,20	907902	53326	64,42	60	1

Ref. Normal	Código Normal	€/ u.	Ref. Magnético	Código Magnético	€/ u.	Longitud cm	Nº asas
907803	53308	54,85	907903	53328	73,76	80	2
907804	53310	62,07	907904	53330	85,51	100	2
907805	53312	68,68	907905	53332	95,25	120	2

5103 - Nivel fundido doble T



Con dos fiolas vertical y horizontal. Con asa para mayor comodidad.

Ref.	Código	Longitud mm	€/ u.
900020	50103-60	760	53,48
900021	50103-80	980	64,09



5102 - Nivel fundido ala de avión



Alta precisión en la nivelación 0,5 mm/m. Fiolas resistentes al impacto y estables frente a los rayos ultravioletas. Garantía de 15 años. Superficies de trabajo mecanizadas para mayor precisión. Perfil de aluminio fundido: alta resistencia.

Ref.	Código	Longitud mm	€/ u.
900016	50102-40	400	36,13
900017	50102-50	500	39,10
900018	50102-60	600	43,69
900019	50102-80	800	52,21



50106 - Nivel fundido ala de avión magnético



Ref.	Código	Longitud mm	€ / u.
900022	50106-60	495	68,88



Nivel digital



•Nivel Digital Profesional de alta calidad PRO900. •Ideal para construcción y reformas. Uso en Interior + Exterior. •Grado de Protección IP65 resistente al polvo y al agua. •Doble display LCD de última generación. Un display frontal y otro superior. •Función de medida: Grado, porcentaje y pendiente. Pantalla retroiluminada. •Función HOLD. Medidas relativas. •Perfil ultra-resistente con extremos antichoque. •Función de autoapagado. Asa ergonómica de agarre. •Funda de transporte incluida. •Fabricado en Polonia.



Ref.	Código	Longitud cm	Nº de fiolas	€ / u.
2403145	53164	40	2	144,90

Nivel digital magnético



•Nivel Digital Profesional de alta calidad PRO900. •Ideal para construcción y reformas. Uso en Interior + Exterior. •Grado de Protección IP65 resistente al polvo y al agua. •Doble display LCD de última generación. Un display frontal y otro superior. •Función de medida: Grado, porcentaje y pendiente. Pantalla retroiluminada. •Función HOLD. Medidas relativas. •Perfil ultra-resistente con extremos antichoque. •Función de autoapagado. • Asa ergonómica de agarre. •Funda de transporte incluida. •Fabricado en Polonia.



Ref.	Código	Longitud cm	Nº de fiolas	€ / u.
2403146	53166	60	2	169,90
2403147	53168	80	2	179,90

Flexómetro



Caja plástico ABS.
Cinta acero esmaltado amarillo.
Clip sujeción y botón de bloqueo.
Homologado CE. Clase II.

Ref.	Código	Ancho cinta	Longitud m	€ / u.
8001895	7103S5	25	5	28,89
8001896	7102S5	19	5	23,11
8001897	7040S3	13	3	11,37
8001898	7101S3	16	3	14,54
8001899	7105S5	25	5	34,30
8001900	7103S10	25	10	48,09



Flexómetro bimataterial



Con freno y clip. Cinta doble cara.

Ref.	Código	Ancho cinta mm	Longitud m	€/ u.
908200	8163	16	3	9,84
908201	8195	19	5	17,44
908202	8255	25	5	23,22
908203	8308	30	8	53,61
908204	8163MP	16	3	9,84
908205	8255MP	25	5	23,22
908206	8308MP	30	8	53,61



Flexómetro inoxidable



Flexómetro con estuche y cinta en acero inoxidable, cinta marcada en ambas caras, grabada en láser. Idóneo para su uso en condiciones extremas. Clase II.

Ref.	Código	Ancho cinta mm	Longitud m	€/ u.
908302	43195	19	3	35,20
908303	45195	19	5	54,57
908304	45255	25	5	66,45
908305	48255	25	8	106,47



Flexómetro ERGO MAGNET



Ref.	Código	Ancho cinta mm	Longitud m	€/ u.
908503	3419M	19	3	8,77
908504	5419M	19	5	10,06
908505	8425M	25	8	20,12



Flexómetro MAXI PRO



Nuevo modelo de flexómetro Heavy Duty. La cinta más ancha con 32 mm, permite realizar mediciones en solitario a grandes distancia. Doble uña especial antideslizante, facilita las mediciones en altura, tubos,... incorpora un práctico imán en su interior.

Ref.	Código	Ancho cinta mm	Longitud m	€/ u.
2403148	3205	32	5	34,88
2403149	3208	32	8	44,62



Flexómetro TRIPLE BACK



Triple: Estuche tri-componente, con acabado soft. Recubierto de Elastollan antideslizante. Black: Cara superior de la cinta en fondo negro con numeración en blanco, cara posterior numeración vertical en negro sobre fondo blanco. Flexómetro con freno, equipado con muñequera textil y clip de cintura. Cinta recubierta de Nylon de alta resistencia.

Ref.	Código	Ancho cinta mm	Longitud m	€/ u.
2403150	7163	16	3	9,10
2403151	7255	25	5	15,41
2403152	7528	16	8	14,50



Flexómetro inoxidable modelo INOX RUBBER



Especialmente indicado para trabajo en medios húmedos y corrosivos. Totalmente Inoxidable. Cinta y muelle en acero inoxidable. Carcasa sobreprotegida con elastómero. Clip para sujetar a la cintura. Cinta plateada recubierta de nylon para mayor durabilidad de la escala. Mecanismo interno de alta calidad para un suave funcionamiento. Clase II.

Ref.	Código	Medida	Espesor de la cinta en mm.	€/ u.
8001916	29326D	3m x 16mm	0,13	13,23
8001917	29327D	5m x 19mm	0,13	20,69
8001918	29329D	8m x 25mm	0,13	35,56



Flexómetro Alta Visibilidad, bloqueo automático modelo SELF LOCK EVOLUTION



Cinta alta visibilidad. Carcasa bi-componente recubierta de elastómero. Cinta recubierta de nylon para mayor durabilidad de la escala. Mecanismo interno de alta calidad para un suave funcionamiento. Clip para sujetar a la cintura. Cinta impresa doble cara en horizontal y vertical. Una magnética de neodimio para facilitar la medición. Potente sistema de bloqueo. Clase II.

Ref.	Código	Medida	Espesor de la cinta en mm.	€/ u.
8001914	29150D	3m x 16mm	0,115	12,43
8001915	29152D	5m x 25mm	0,115	20,63



Flexómetro Alta Visibilidad, magnético modelo POWER BLADE 2 CROMADO



Cinta Alta Visibilidad. Cinta recubierta de nylon para mayor durabilidad de la escala. Doble uña magnética de neodimio para facilitar la medición. Cinta marcada por ambos lados. Mecanismo interno de alta calidad para un suave funcionamiento. Clip para sujetar a la cintura. Cinta impresa doble cara en horizontal y vertical. Clase II.

Ref.	Código	Medida	Espesor de la cinta en mm.	€/ u.
8001919	29201D	5m x 27mm	0,15	20,80
8001920	29202D	8m x 27mm	0,15	28,02



Flexómetro cromado CL



FLEXÓMETRO ESTUCHE ABS CROMADO 3MX13MM SIN FRENO

Ref.	Código	Ancho cinta mm	Longitud m	€/ u.
908254	CL-1313 C/F	25	8	4,45



Flexómetro autolock



Flexómetro anti-choque y autofreno 3mx16mm

Ref.	Código	Ancho cinta mm	Longitud m	€/ u.
908352	99193	25	8	6,36



Flexómetro compacto modelo PROHANDS



Diseño compacto para comodidad de uso. Cinta con protección de acrílico. Cinta blanca para una cómoda lectura. Mecanismo interno de alta calidad para un suave funcionamiento. Clip para sujetar a la cintura. Clase II.

Ref.	Código	Medida	Espesor de la cinta en mm.	€/ u.
8001904	29290D	3m x 16mm	0,115	6,37
8001905	29292D	5m x 16mm	0,115	9,17



Flexómetro con bloqueo automático modelo SELF LOCK



Carcasa bi-componente recubierta de elastómero. Potente sistema de bloqueo. Cinta recubierta de nylon para mayor durabilidad de la escala. Mecanismo interno de alta calidad para un suave funcionamiento. Clip para sujetar a la cintura. Clase II.

Ref.	Código	Medida	Espesor de la cinta en mm.	€/ u.
8001910	29300D	3m x 16mm	0,115	12,59
8001911	29301D	5m x 19mm	0,115	16,52
8001912	29302D	5m x 25mm	0,115	19,69
8001913	29303D	8m x 25mm	0,115	27,58



Flexómetro Komelon doble cara con luz led



•Cinta blanca antideslumbrante. •Carcasa ultra compacta. •LED potente e innovador. •Interruptor de luz LED ergonómico y práctico. •Recubrimiento de Nylon para mayor durabilidad de la escala. •Gancho de alta calidad con tratamiento térmico extra. •Mecanismo interno de alta calidad para un suave funcionamiento. •Clip para sujetar a la cintura. •Clase II. •Incluye cable USB para carga. • Características de la batería: Batería de polímero de litio 3,7 V, 90 mAh. Autoapagado después de 5 minutos. Modo carga rápida.

Ref.	Código	Medida	Espesor	€/ u.
21006000	*8803005002039	8 m x 25 mm	0,115	29,16



Flexómetro con luz LED, doble cara modelo "Led Light"



•Cinta blanca antideslumbrante. Carcasa ultra compacta. •LED potente e innovador. •Interruptor de luz LED ergonómico y práctico. •Recubrimiento de Nylon para mayor durabilidad de la escala. •Gancho de alta calidad con tratamiento térmico extra. •Mecanismo interno de alta calidad para un suave funcionamiento. •Clip para sujetar a la cintura. •Clase II. •Incluye cable USB para carga. Batería de polímero de litio 3,7 V, 90 mAh.

Ref.	Código	Medida	Espesor de la cinta en mm.	€ / u.
21006000	29092D	8m x 25mm	0,115	29,16
2403153	29382D	5m x 25mm	0,115	41,98



Flexómetro con doble freno modelo PRO ERGO-R



• Cinta marcada por ambos lados. • Cinta recubierta de nylon para mayor durabilidad de la escala. • Carcasa bi-componente recubierta de elastómero. • Doble uña magnética de neodimio para facilitar la medición. • Clip para sujetar a la cintura. • Mecanismo interno de alta calidad para un suave funcionamiento. • Cinta impresa doble cara en horizontal y vertical. • Clase II.

Ref.	Código	Medida	Espesor de la cinta en mm.	€ / u.
8001906	29306D	3m x 16mm	0,115	6,03
8001907	29307D	5m x 19mm	0,115	9,10
8001908	29309D	8m x 25mm	0,115	15,41
8001909	29310D	10m x 25mm	0,115	19,59



Flexómetro magnético modelo MAGGRIP DUBLIX



Cinta marcada por ambos lados. Cinta recubierta de nylon para mayor durabilidad de la escala. Carcasa bi-componente recubierta de elastómero. Doble uña magnética de neodimio para facilitar la medición. Clip para sujetar a la cintura. Mecanismo interno de alta calidad para un suave funcionamiento. Cinta impresa doble cara en horizontal y vertical. Clase II.

Ref.	Código	Medida	Espesor de la cinta en mm.	€ / u.
8001921	29296D	3m x 16mm	0,115	12,30
8001922	29297D	5m x 19mm	0,115	16,19
8001923	29298D	5m x 25mm	0,115	19,69
8001924	29299D	8m x 25mm	0,115	25,43



Cinta métrica adhesiva Komelon alta visibilidad



Cinta métrica de acero de alta visibilidad con potente adhesivo. Recubrimiento especial de nylon para mayor durabilidad de la escala. Doble graduación en mm, en la parte superior e inferior de la cinta. Números de cm en negro y en continuo. Números de dm en rojo.

Ref.	Código	Medida	Espesor	€ / u.
21006002	53168.jpg	1 m x 13 mm	0,115	6,71
21006003	50043.jpg	2 m x 13 mm	0,115	7,39
21006004	50041.jpg	3 m x 13 mm	0,115	11,50



Cinta métrica de acero bastidor ABS modelo UNIGRIP



Sólido bastidor de ABS resistente a condiciones extremas. Cantos con protección de goma. Asa ergonómica. Cinta recubierta de nylon para mayor durabilidad de la escala. Clase II.

Ref.	Código	Longitud	Ancho	€/ u.
8001925	53164.jpg	30 m	13 mm	63,13
8001926	53166.jpg	50 m	13 mm	95,46



Cinta métrica de acero estuche metálico



Cinta de acero, recubierta de nylon, en color amarillo, de precisión Clase II. La carcasa es metálica (robusta y resistente), con forro simil piel. La hebilla es metálica. Numeración en mm. y cm. La graduación comienza en el extremo de la cinta. Con uña metálica retráctil para fijar el comienzo de la medición.

Ref.	Código	Ancho cinta mm	Longitud m	€/ u.
908300	50042.jpg	13	10	31,12
908301	50050.jpg	13	15	37,65
908296	54844	13	20	43,98
908297	54845	13	25	51,31
908298	54846	13	30	58,33
908299	54847	13	50	82,51



Cinta métrica de acero recogido rápido modelo FASTBACK ERGO



Engranaje de alta velocidad para una rápida recogida. Carcasa compacta y ergonómica para un agarre confortable. Cinta recubierta de nylon para mayor durabilidad de la escala. Uña magnética de neodimio para facilitar la medición. Clase II.

Ref.	Código	Longitud m	Ancho mm	€/ u.
8001927	29505D	20	10	33,21
8001928	29506D	30	10	44,32



Cinta métrica de acero bastidor ABS modelo UNIGRIP ERGO



Asidero de goma para mejorar la sujeción. Manivela abatible para una rápida recogida de la cinta. Carcasa ergonómica y confortable. Cinta recubierta de nylon para mayor durabilidad de la escala. Clase II.

Ref.	Código	Longitud m	Ancho mm	€/ u.
8001929	29510D	20	10	23,67
8001930	29511D	30	10	28,38



Cinta métrica en fibra de vidrio estuche metálico



Graduación bimilimétrica impresa en ambas caras. Precisión clase II.

Ref.	Código	Ancho cinta mm	Longitud m	€/ u.
908602	#N/A	15	20	68,16
908603	#N/A	15	25	77,79
908604	#N/A	15	30	82,28
908605	#N/A	15	50	119,41



Cinta métrica metálica bimaterial cerrada



Ref.	Código	Ancho cinta mm	Longitud m	€/ u.
909002	#N/A	13	20	53,82
909004	#N/A	13	30	65,27
909005	#N/A	13	50	87,63



Cinta métrica metálica abierta



Alta velocidad de retorno 3:1.

Ref.	Código	Ancho cinta mm	Longitud m	€/ u.
909600	#N/A	13	50	82,50
909601	#N/A	13	100	138,46



Cinta métrica de fibra de vidrio bastidor ABS modelo UNIGRIP FLX



Sólido bastidor de ABS resistente a condiciones extremas. Cantos con protección de goma. Cinta impresa doble cara. Cinta garantizada de por vida gracias al doble revestimiento de fibra de vidrio Komelon. Clase II.

Ref.	Código	Longitud m	Ancho mm	€/ u.
8001931	29530D	30	13	26,69
8001932	29531D	50	13	38,40
8001933	29532D	100	13	74,73



Cinta métrica estuche abierto



Ref.	Código	Ancho cinta mm	Longitud m	€/ u.
908750	1775n.jpg	15	30	36,38
908751	#N/A	15	50	61,85
2403154	1775	15	100	109,46



Cinta métrica de fibra de vidrio modelo UNIGRIP NEO



Carcasa ergonómica para una buena sujeción en la mano. Manivela abatible para una rápida recogida de la cinta. Cinta impresa doble cara. Cinta garantizada de por vida gracias al doble revestimiento de fibra de vidrio Komelon. Clase II.

Ref.	Código	Longitud m	Ancho mm	€/ u.
8001934	29535D	10	13	16,08
8001935	29536D	20	13	20,52
8001936	29537D	30	13	25,07
8001937	29538D	50	13	35,39



Medidor de distancia Láser Pro



Mediciones de distancia mediante láser hasta 40/60/100 m. Unidades de medición: mm/pulgadas/pies. Resolución: 0,001 m (1 mm). Precisión: ± 2 mm. Nivel electrónico y medición de ángulos. Funciones de medida de área y volumen. Con memoria: almacenamiento interno de medidas. Función medición directa y medición continua. Función añadir / restar mediciones. Cálculo por el teorema de Pitágoras. 4 modos para medirlo todo. Función PINTOR: Suma de superficie de paredes. 3 puntos de referencia de medición: Desde la lente, trípode o pared. Pantalla retroiluminada y botones con sonido seleccionable. Autoapagado e indicador del estado de la batería. Tipo de láser: 635 nm. Clase II. Intuitivo y muy fácil de usar. Con correa y estuche incluidos. IP54. Compatible con trípode TR420F.

Ref.	Código	Dimensiones mm	Alcance	Precisión	€/ u.
21006035	54351	188 x 92 x 50	40 m	± 2 mm	114,56
21006036	54352	189 x 92 x 50	60 m	± 2 mm	128,51
21006037	54353	190 x 92 x 50	100 m	± 2 mm	149,63



Medidor de distancias digital



Ref.	Código	Normativa	€/ u.
21117022	LDM100H	CE /	109,60



Nivel láser en cruz SMART-PRO



Nivel Láser ROJO/VERDE en cruz con alcance hasta 15 m. Para Interior + Exterior. Generación de haz vertical y horizontal formando un ángulo de 90°C ultra-preciso. Precisión: 0,3 mm/m. Súper-compacto. Reducidas dimensiones. Equipado con diodo láser de alta estabilidad y visibilidad. Autorregulación por péndulo en superficies inestables. Bloqueo mecánico del péndulo para marcar ángulos deseados. Resistente al agua y polvo. IP54. Soporte universal de cabeza móvil incluido. Bolsa de transporte incluida. Compatible con Trípode TR420F.



Ref.	Código	Dimensiones mm	Alcance	Precisión	Color	€/ u.
21006038	54310D	76 x 66 x 76	15 m	0.3 mm/m	Rojo	94,90
21006039	54311D	77 x 66 x 76	25 m	0.3 mm/m	Verde	154,90

Nivel láser de puntos autonivelantes

BOSCH

Ref.	Código	Modelo	Nº de puntos	Peso kg	€ / u.
21022024	0601066N00	GPL 3 G PROFESSIONAL	3	0,35	268,00
21022025	0601066P00	GPL 5 G PROFESSIONAL	5	0,35	319,00



0601066N00

0601066P00

Nivel láser de líneas autonivelantes

BOSCH

Ref.	Código	Modelo	Proyección líneas/puntos	Contenido	Peso kg	€ / u.
20015103	601066	GCL 2-15 + RM1 PROFESSIONAL	2/2	con 3 pilas (AA), placa reflectora de medida del láser	0,49	203,00



Nivel láser de puntos autonivelantes

BOSCH

Ref.	Modelo	Proyección líneas/puntos	Protección contra polvo y salpicaduras de agua	Peso kg	€ / u.
2403155	GLL 2-15 G Professional + LB 10	2/2	IP64	0,57	235,00
2403156	GCL 2-50 G Professional + RM10	2/2	IP64	0,58	337,00
2403157	GLL 3-80 Professional	3	IP54	0,82	529,00



Medidor láser 50 m con nivel digital para trabajos de medición y cálculo de presupuestos / MED50R

BELLOTA

Medidor láser con un alcance de 50 metros (Laser Clase II), con nivel digital, precisión de 2 mm/m y protección IP54 a salpicaduras de líquidos y polvo. Permite medición continua, cálculo de suma y resta, área, volumen, función Pitágoras. Pantalla iluminada y 99 memorias. Incluye funda, correa y 2 pilas 1,5V AAA. Cuerpo resistente con topes laterales anti impactos de plástico. Para trabajos de medición profesional y cálculo de presupuestos.

Ref.	Código	Láser	Precisión mm/m	€ / u.
2403159	MED50R	Rojo	0.05-50	71,00



Nivel láser en cruz

BELLOTA

Nivel láser en cruz con un alcance de 20 metros (Laser Clase II), apertura de haz de vertical 120° y haz horizontal 120° y autonivelante en superficies inclinadas de hasta 4°. Precisión de 0,3 mm/m y protección IP54 a salpicaduras de líquidos y polvo. Permite bloqueo del péndulo para garantizar el transporte y poder usarlo inclinado. Alarma visual cuando no está a nivel. Tiene rosca 1/4"; incluye soporte magnético, funda, manual de instrucciones y 2 pilas 1,5V AA. Cuerpo resistente con topes laterales anti impactos de plástico. Para trabajos de nivelación profesional.

Ref.	Código	Láser	Precisión mm/m	€ / u.
	NIV20R	Rojo	0.3	86,23
2403161	NIV20V	Verde	0.3	106,53



Nivel láser 3x360 en cruz



Nivel láser en cruz con plomada, alcance de 30 metros (Laser Clase II), apertura de haz de vertical 180° y haz horizontal 120°, con 2 intensidades de trabajo y autonivelante en superficies inclinadas de hasta 4°. Precisión de 0,3 mm/m y protección IP54 a salpicaduras de líquidos y polvo. Permite bloqueo del péndulo para garantizar el transporte y poder usarlo inclinado. Alarma visual cuando no está a nivel. Tiene rosca 1/4", incluye maleta, soporte magnético, pinza, gafas, placa reflectora magnética, manual de instrucciones y 4 pilas 1,5V AA. Cuerpo resistente con topes laterales anti impactos de plástico. Para trabajos de nivelación profesional.



Ref.	Código	Láser	Precisión mm/m	€ / u.
2403162	NIV30V	Verde	0.3	202,95

Nivel láser 3x360



Nivel láser de 3 planos por 360°, con un alcance de 30 metros (Laser Clase II). Autonivelante en superficies inclinadas de hasta 4°. Precisión de 0,3 mm/m y protección IP54 a salpicaduras de líquidos y polvo. Permite bloqueo del péndulo para garantizar el transporte y poder usarlo inclinado. Alarma acústica cuando no está a nivel. Tiene rosca 1/4", incluye maleta, soporte magnético, pinza, gafas, placa reflectora magnética, manual de instrucciones y batería Li-ion 3,7V 5200 mAh. Cuerpo resistente con topes laterales anti impactos de plástico. Para trabajos de nivelación profesional.

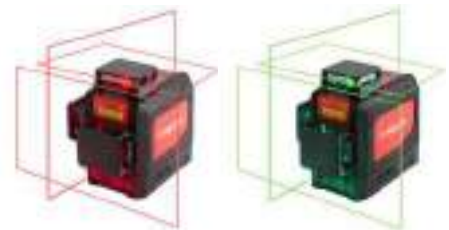

Ref.	Código	Láser	Precisión mm/m	€ / u.
2403163	NIV30360R	Rojo	0.3	304,45
2403164	NIV30360V	Verde	0.3	405,95

Topómetro



Topómetro con dos botones de reset y freno. Con bolsa de transporte.

Ref.	Ø rueda mm	€ / u.
909650	320	307,41



Telescopio



Ref.	Rango de medición m	€ / u.
909800	0,75 x 3	232,40
909801	0,90 x 4	241,93
909802	1,10 x 5	270,39



Contador manual



Con puesta a cero por botón.

Ref.	Nº cifras	€ / u.
909903	4	9,74



Cronómetro digital



Ref.	Precisión	€ / u.
909950	1/100 seg.	25,38



Rueda Topómetro



Contador mecánico de hasta 9.999 m. Mango telescópico. Con freno en la empuñadura. Se suministra con una práctica mochila para su transporte.

Ref.	Código	Ø Rueda en cm	Circunferencia en cm	Longitud total extendido en cm.	Peso kg	€ / u.
8002061	54903	32	100,5	100	2,074	180,49



Rueda topómetro Komelon



Topómetro compacto de hasta 10.000 m. Cómoda empuñadura de pistola. Mango telescópico y plegable con bloqueo. Banda de rodadura antideslizante para mejorar la tracción. Estructura de alta visibilidad. Lente de aumento para mejorar la legibilidad. Contador impulsado por engranaje exacto con el botón reajustado. Soporte plegable con resorte integrado en la carcasa del contador.

Ref.	Código	Medición	Rueda cm	€ / u.
21006005	54904	Max 10.000 m	25	93,33
21006006	54905	Max 10.000 m	36	105,41



Detector digital



Ref.	Código	Modelo	Materiales detectables	Profundidad máx. de detección	Profundidad de detección en acero, máx.	Profundidad de detección de cobre, máx.	Profundidad de detección de cables conductores de corriente, máx.	Peso kg	€/ u.
8000344	601081000	GMS 120	Metales férreos, metales no férreos, subestructuras de madera, cables eléctricos de alta tensión	120	120	80	50	0,22	139,00

Medidor de espesor de revestimiento por inducción magnética



Indicado para medir recubrimientos de pintura, galvanizados, cromados, etc. en superficies metálicas. Rango: de 0 a 1.200 um. Resolución: 1 um. Para materiales como fierros, aceros, aceros inoxidable. Para revestimientos como pintura, goma, galvanizados, cromados, cincados...

Ref.	Código	Medida mm	Peso grs.	€/ u.
908356	57721	165x60x30	190	615,73



Medidor de humedad de materiales



- MINI Medidor digital de humedad y Temperatura de materiales PROFESIONAL.
- Medición de HUMEDAD de 7 tipos de Materiales: Desde 0,0% hasta 60,0%
- Medición de Temperatura: Desde -10°C hasta 50°C
- Medición de Humedad Relativa: Desde -10% hasta 90%
- Profundidad de 0 a 50 mm
- Velocidad de muestreo: 240 ms
- Retención de lecturas en pantalla
- Función autoapagado e indicador de batería baja.
- Display retroiluminado
- Bolsa de transporte incluida
- Certificado de calibración de fábrica incluido.



Ref.	Código	Humedad Relativa	Temperatura	Humedad Materiales	€/ u.
8005036	50055	10 - 90%	-10°C ~ 50°C 14°F ~ 122°F	0 - 60%	45,57

Anemómetro + Caudalímetro digital profesional



- Anemómetro digital
- Medición de velocidad y del caudal volumétrico del aire en diferentes unidades
- Velocidad del aire: m/s, pies/min, km/h, millas/h, milla náutica/h.
- Ajuste del área de paso.
- Valores máximo y mínimo.
- Retención de lecturas
- Autoapagado e indicación de batería baja.
- Pantalla retroiluminada.
- Bolsa de transporte incluida
- Certificado de calibración de fábrica incluido.



Ref.	Código	Dimensiones (mm)	m/s (metros por segundo)	km/h (kilometros por hora)	ft/s (pies por segundo)	Nudos Millas náuticas por hora	mile/h (millas por hora)	ft/m (pies por minuto)	€ / u.
8005033	50052	68 x 60 x 56	0,80 ~ 30,00 m/s 30,00 ~ 40,00 m/s	2,88 ~ 108,0 km/h 108,0 ~ 144,0 km/h	2,62 ~ 98,50 ft/s 98,5 ~ 131,2 ft/s	1,6 ~ 58,30 knots 58,30 ~ 77,70 knots	1,8 ~ 67,20 mile/h 67,20 ~ 90,00 mile/h	157,5 ~ 5900 ft/m 5900 ~ 7874 ft/m	108,19

Sonómetro digital profesional



- Sonómetro Digital tipo II según IEC 651.
- Rango de medida: 30dB a 130dB.
- Precisión: 2dB. 2000 cuentas.
- Resolución: 0,1dB.
- Indicación numérica en display y por gráfico de barras.
- Rango de frecuencias: 30Hz a 8kHz.
- Frecuencia de muestreo: 2 veces por segundo.
- Indicación en display de medida fuera de rango.
- Retención de lecturas en pantalla, valor máximo.
- Valoración de frecuencias A y C.
- Selección FAST/SLOW.
- Función autoapagado e indicador de batería baja. Display retroiluminado.
- Bolsa de transporte incluida
- Certificado de calibración de fábrica incluido.



Ref.	Código	Nivel de presión sonora	€ / u.
8005035	50054	30dB ~ 80dB 0,1 dB ±1,5 dB 40dB ~ 90dB 0,1 dB ±1,5 dB 50dB ~ 100dB 0,1 dB ±1,5 dB 60dB ~ 110dB 0,1 dB ±1,5 dB 70dB ~ 120dB 0,1 dB ±1,5 dB 80dB ~ 130dB 0,1 dB ±1,5 dB	143,19

Luxómetro digital profesional



- Medidor de luz digital de alta precisión. 2000 cuentas. Función retención de lecturas
- Selección de unidad Fc/Lux/CD.
- Cambio entre diferentes fuentes de iluminación.
- Medida de todo tipo de lámparas, incluidas lámparas LED
- Indicación de batería baja y apagado automático
- Diseño compacto, duradero y portátil
- Bolsa de transporte incluida
- Certificado de calibración de fábrica incluido.



Ref.	Código	Rango de Medidas	Selector fuentes de luz	€ / u.
8005034	50053	0 ~ 200.000 Lux 0 ~ 20.000 FC 0 ~ 999.900 CD	L0: Iluminación standard L1: LED - Luz diurna L2: LED - Luz roja L3: LED - Luz ámbar L4: LED - Luz verde L5: LED - Luz azul L6: LED - Luz morada L7 - L9: Iluminación standard por defecto	101,82

Luxómetro digital



Cumple la normativa JISC 1609:1993 & CNS 5119 Clase A



Ref.	Código	Normativa	€/ u.
21117021	ST3809	CE / JISC 1609:1993 / CNS 5119 Clase A	149,20

Tacómetro digital profesional sin contacto



• Medida de velocidades angulares de 50 a 20.000 rev/min. • Distancia de medida: 50 a 250mm. • Retención de lecturas en pantalla • Retención de valores máximo, mínimo y promedio • Registro de hasta 100 medidas. Función autoapagado e indicador de batería baja. • Display retroiluminado • Bolsa de transporte incluida • Certificado de calibración de fábrica incluido.



Ref.	Código	Medidas	€/ u.
8005038	50072	50 - 99,99 RPM 100 - 9.999,9 RPM 10.000 - 19.999 RPM	95,45

Comprobador de diferenciales digital



Cumple la normativa EN6010-1. CAT III 1000 V.



Ref.	Código	Comprobador de	Intensidad de disparo	Tensión alterna	Normativa	€/ u.
21117023	ST5554	Diferenciales	10/30/100/300/500mA & 1A	207 a 253 V AC	CE / EN6010-1 / CAT III 1000 V	179,65

Pinza amperimétrica digital



Ref.	Código	Apertura pinza mm	Corriente	Memoria valores de medición	Proceso medición	Resistencia	Tensión alterna	Tensión continua	Normativa	€/ u.
1802374	M266	55	0-1000A AC	HOLD	-	2 MΩ	0-600 V	0-600 V		12,65
2403165	KS402N	26	0-600A AC	HOLD/MAX	TRMS	60 MΩ	0-600 V	0-600 V	CE / EN6010-1 / CAT III 600 V	39,95
2403166	KS400N	26	0-600A AC/DC	HOLD/MAX	TRMS	60 MΩ	0-600 V	0-600 V	CE / EN6010-1 / CAT III 600 V	59,95
1802387	ST351	30	0-400A AC/DC	HOLD/REL	-	40 MΩ	0-600 V	0-600 V		102,35
1802388	ST357	40	0-1000 AC/DC	HOLD/REL/MAX/MIN	TRMS	50 MΩ	0-750 V	0 - 1000 V		159,00

Pinza amperimétrica digital



Ref.	Código	Apertura pinza mm	Corriente	Memoria valores de medición	Proceso medición	Resistencia	Tensión AC/DC	Normativa	€/ u.
21117010	ST350	30	0-400A AC	HOLD	-	40 MΩ	600 V AC&DC	CE / EN6010-1 / CAT III 600 V	55,15
21117011	ST3391	52	0-1000A AC	HOLD	TRMS	40 MΩ	1000 V AC&DC	CE / EN6010-1 / CAT IV 600 V	117,30
21117012	ST3395	52	0-1000A AC/DC	HOLD/REL/MAX	TRMS	60 MΩ	1000 V AC&DC	CE / EN6010-1 / CAT IV 600 V	137,90

Pinza amperimétrica digital avanzada TRMS



Mini-Pinza digital Medición de tensión AC/DC, corriente AC y resistencia. Medidas en verdadero valor eficaz (TRMS) Continuidad y diodos Valores máximos y retención de datos. Escala automática Autoapagado e indicador de batería baja Pantalla retroiluminada Bolsa de transporte incluida Certificado de calibración de fábrica incluido.



Ref.	Código	Voltaje DC	Voltaje AC	Corriente AC	Resistencia	€/ u.
8005030	50022	2V/20V/200V/600V	2V/20V/200V/600V	600A	200Ω/2KΩ/20KΩ/200KΩ/2MΩ/20MΩ	69,90

Pinza amperimétrica digital TRMS Industrial



Pinza amperimétrica digital TRMS. •Medición de tensión DC/AC (1000V) y corriente DC/AC (1000A)Medición de corriente de arranque (1000A). Medición de resistencia (60MΩ), capacitancia (100mF), frecuencia (10MHz) y ciclo de trabajo. Medidas en verdadero valor eficaz (TRMS). Avisador acústico de continuidad y prueba de diodos. Detección de tensión sin contacto (NCV). Valores MAX/MIN. Medidas relativas. Retención de lecturas. 6000 cuentas. Escala automática. Autoapagado e indicador de batería baja. Pantalla retroiluminada y luz de trabajo. Se suministra con cables. Certificado de calibración de fábrica incluido.



Ref.	Código	Voltaje DC	Voltaje AC	Corriente DC	Corriente AC	Corriente arranque	Resistencia	Capacitancia	Frecuencia (A)	Frecuencia (V)	Frecuencia (Hz/Duty)	Ciclo de trabajo	€ / u.
21006001	50024	60mV / 600mV / 6V / 60V / 600V / 1000V	60mV / 600mV / 6V / 60V / 600V / 750V	60A / 600A / 1000A	60A / 600A / 1000A	60A / 600A / 1000A	600Ω / 6kΩ / 60kΩ / 600kΩ / 6MΩ / 60MΩ	10nF / 100nF / 1000nF / 10μF / 100μF / 1000μF / 10mF / 100mF	100Hz / 1000Hz	100Hz / 1000Hz / 10kHz	10Hz / 100Hz / 1000Hz / 10kHz / 100kHz / 1000kHz / 10MHz	0,1% - 99,9%	109,90

Comprobador de Tierra con Picas / Bucle



Cumple la normativa EN6010-1. CAT III 1000 V.



Ref.	Código	Medidor de	Precisión	Prueba de corriente	Rango de resistencia de aislamiento	Resistencia	Tensión de prueba/medida	Normativa	€ / u.
1802376	ST5300B	Tierra	±0,8%-3dig	-	-	20/200/2000Ω		CE IEC61010-1 CAT iii 1000V	140,35
21117014	ST5301	Tierra				0 a 2000Ω	50 a 250 V AC		169,80

Medidor de aislamiento digital



Cumple la normativa EN6010-1. CAT III 600 V.



Ref.	Código	Medidor de	Precisión	Prueba de corriente	Rango de resistencia de aislamiento	Resistencia	Tensión de prueba/medida	Normativa	€ / u.
1802375	ST5500	Aislamiento	±3,5%-5dig	≤1mA	200 y 2000MΩ	200Ω-200KΩ	250/500/1000V	CE IEC6010-1, CAT III 1000V	173,90

Detector de tensión sin contacto



Cumple la normativa EN6010-1. CAT III 1000 V.



Ref.	Código	Tensión AC/DC	Normativa	€/ u.
21117015	AC9B	100 a 1000 V AC	CE / EN6010-1 / CAT III 1000 V	12,45

Comprobador de tensión a Leds



Cumple la normativa EN6010-1. CAT III 400 V.



Ref.	Código	Tensión AC/DC	Normativa	€/ u.
21117016	ST9011	6 a 400 V AC&DC	CE / EN6010-1 / CAT III 400 V	17,00

Comprobador de tensión y Continuidad a LEDs



Cumple la normativa EN6010-1. CAT III 1000 V.



Ref.	Código	Tensión alterna	Tensión continua	Normativa	€/ u.
21117017	ST9902	12 a 690 V AC	6 a 220 V DC	CE / EN6010-1 / CAT III 1000 V	31,50

Comprobador de tensión AC/DC y Polaridad



Detector de tensión con contacto. Indicadores LED de tensión: 12V, 24V, 50V, 120V, 230V y 400V. Indicación de la polaridad de tensiones DC. Comprobación del funcionamiento de diferenciales. IP 54. CATIII 400V.



Ref.	Código	Dimensiones mm	Indicadores LED de tensión	€/ u.
2403167	50043	223 x 40 x 32	12V, 24V, 50V, 120V, 230V y 400V	20,83



Detector de tensión sin contacto



Detector de tensión AC sin contacto.
Sensibilidad: 90 - 1.000VAC 50/60Hz.
Indicadores: Pitido y LED.
CATIII 600V, CATII 1000V.
Certificado de calibración de fábrica incluido.



Ref.	Código	Dimensiones mm	Sensibilidad	Indicadores	€ / u.
2403168	50041	148 x 17 x 26	90 - 1.000VAC 50/60Hz	Pitido y LED.	9,80

Detector de metales y tensión sin contacto



- Detector de tensión sin contacto.
- Sensibilidad: 20 - 1000V 50-500Hz
- Indicadores: Pitido y LED.
- Detección de metales: <20 mm.
- Ajuste y memorización de la sensibilidad.
- Autoapagado e indicación de batería baja.
- CATIII 600V, CATII 1000V



Ref.	Código	Dimensiones mm	Sensibilidad	Indicadores	€ / u.
2403169	50042	157 x 24 x 20	20 - 1000V 50-500Hz	Pitido y LED.	30,24

Multímetro digital



Ref.	Código	Capacidad	Frecuencia	Intensidad AC/DC	Resistencia	Retención de lectura	Temperatura °C	Tensión AC/DC	Normativa	€ / u.
1802372	MY64	20 uF	20 kHz	10 A	200MΩ	SI	1370 °C	600 V AC&DC	CE / EN61010-1 / CAT. II 600V	23,10
1802389	EM369	-	-	10 A	20MΩ	Sí	1000 °C	600 V AC&DC	CE / EN61010-1 / CAT. II 600V	30,80
1802390	ST9905	200 uF	-	20 A	200MΩ	-	-	700 V AC&1000 V DC	CE / EN61010-1 / CAT. III 600V	48,80
1802371	MAS830L	-	-	5 A	2MΩ	Sí	-	500 V AC&DC	CE / EN61010-1 / CAT. II 500V	11,55
21117013	ST9927T	1000 uF	40 MHz	10 A	60MΩ	Sí	750 °C	1000 V AC&DC	CE / EN6010-1 / CAT IV 600 V	98,50

Multímetro digital TRMS SUPER-PRO con interfaz USB



Medición de tensión AC/DC (1000V), corriente AC/DC, resistencia, capacidad y frecuencia. Mediciones en verdadero valor eficaz (TRMS). Continuidad y diodos. Detección de tensión sin contacto. Valores máx. y min. Medidas relativas. Escala automática y retención de lecturas Autoapagado e indicador de batería baja Pantalla retroiluminada. Interfaz USB para comunicación con PC. Cable USB incluido Certificado de calibración de fábrica incluido.



Ref.	Código	Voltaje DC	Voltaje AC	Corriente DC	Corriente AC	Resistencia	Capacitancia	Frecuencia	Ciclo de trabajo	€ / u.
8005029	50005	660mV 6,6V / 66V / 660V / 1000V	660mV 6,6V / 66V 660V / 1000V	660µA / 6600µA / 66mA / 10A	660µA / 6600µA / 66mA / 10A	660W / 6,6KW / 66KW / 660kW / 6,6MW / 66MW	6,6nF 66nF / 660nF / 6,6µF / 66µF / 660µF	66Hz / 660Hz / 6,6KHz / 66KHz 660KHz / 6,6MHz / 66MHz	0,1% - 99%	109,90

Multímetro digital profesional básico



Medición de tensión AC/DC (600V), corriente DC y resistencia. Continuidad y diodos. Retención de lecturas e indicador de batería baja Certificado de calibración de fábrica incluido



Ref.	Código	Voltaje DC	Voltaje AC	Corriente DC	Resistencia	€ / u.
8005026	50002	200mV/2V/20V/200V/600V	200V/600V	200µA/2000µA/20mA/200mA/10A	200Ω/20KΩ/200KΩ/200KΩ/2MΩ	44,90

Multímetro digital de bolsillo - Extraplano



Medición de tensión AC/DC, corriente DC y resistencia. Continuidad y diodos. Indicador de batería baja Extraplano: Menos de 2 cm



Ref.	Código	Voltaje DC	Voltaje AC	Corriente DC	Resistencia	€ / u.
8005025	50001	2V/20V/200V/500V	200V/500V	200mA	2KΩ/20KΩ/200KΩ/2MΩ	26,90

Multímetro digital profesional completo 10 en 1



Multímetro digital CON 10 FUNCIONES de medida Medición de tensión AC/DC (600V), corriente AC/DC, resistencia, capacidad, frecuencia y temperatura. Continuidad y diodos. Escala automática. Retención de lecturas, autoapagado e indicador de batería baja Pantalla retroiluminada. Certificado de calibración de fábrica incluido.



Ref.	Código	Voltaje DC	Voltaje AC	Corriente DC	Corriente AC	Resistencia	Capacitancia	Frecuencia (V/A)	Frecuencia (Hz/Duty)	Ciclo de trabajo	Temperatura	€ / u.
8005028	50004	400mV / 4V / 40V / 400V / 600V	4V / 40V / 400V / 600V	400µA / 4000µA / 40mA / 10A	400mA / 4000mA / 40mA / 10A	400W / 4KW / 40KW / 400KW / 4MW / 40MW	5nF / 50nF / 500nF 5µF / 50µF / 100µF	10Hz / 100Hz / 1000Hz / 10KHz / 100KHz / 1000KHz / 10MHz	100KHz / 1000KHz / 10MHz	0,1% - 99%	-20°C - 1000°C / -4°F - 1832°F	99,90

Multímetro digital profesional avanzado 3 en 1



3 en 1: MULTÍMETRO + DETECTOR DE TENSIÓN + TERMÓMETRO Medición de tensión AC/DC (600V), corriente AC/DC, resistencia y temperatura. Continuidad y diodos. Detección de tensión sin contacto. Valores máximos. Escala automática. Retención de lecturas, autoapagado e indicador de batería baja Pantalla retroiluminada. Certificado de calibración de fábrica incluido.



Ref.	Código	Voltaje DC	Voltaje AC	Corriente DC	Corriente AC	Resistencia	Temperatura	€ / u.
8005027	50003	200mV / 2V / 20V / 200V / 600V	2V / 20V / 200V / 600V	200µA / 2000µA / 20mA / 200mA / 10A	200µA / 2000µA / 20mA / 200mA / 10A	200Ω / 2KΩ / 20KΩ / 200KΩ / 2MΩ / 20MΩ	-20°C-0°C / -4°F - 32°F 0°C-400°C / 33°F-752°F 400°C-1000°C / 752°F-1832°F	54,90

Termómetro digital



Normativa ST8806S: EN ISO 80601-2-56:2013 ; ASTM E 1965-1998 : EN980; EN1041; EN 60601-1-11:2015 ; EN 60601-1-2:2015 EN1041 ; EN 60601-1-11: 2015

Ref.	Código	Normativa	€ / u.
21117018	ST8811H	CE /	83,00
21117019	ST8806S	CE /	58,95
21117020	ST131	CE /	15,15



Termómetro láser infrarrojo 300° C



Termómetro digital infrarrojo de hasta 300°C + Higrómetro. Tiempo de respuesta 1 segundo. Puntero láser <1m W/ 630-670nm. Escala automática. •Medida de temperatura y humedad relativa. Emisividad: 0,95. Relación óptica D-S=10:1. Indicación en: °C (Celsius) ó °F (Fahrenheit). •Pantalla retroiluminada e indicador de batería baja. Probado y certificado según IEC/EN 61326. Retención de lecturas en pantalla. Pilas incluidas.



Ref.	Código	Descripción	Temperatura IR	Resolución	Repetitividad	Emisividad	Resolución óptica	€ / u.
2403170	50050	Termómetro láser infrarrojo 300° C	0 a 300°	0,1°C/ 0,2°F	± 0,1°C	0,95	10:1	49,32



ASIDE

Capelamendi 1 - Pabellón 43

01013 VITORIA - GASTEIZ

Telf.: 945 287 583

aside@aside.es

—

www.aside.es